



**HAL**  
open science

## Animal management and feed intake

G Waghorn, C Pinares-Patiño, G Molano, A Berndt, Cécile Martin

► **To cite this version:**

G Waghorn, C Pinares-Patiño, G Molano, A Berndt, Cécile Martin. Animal management and feed intake. Guidelines for use of sulphur hexafluoride (SF<sub>6</sub>) tracer technique to measure enteric methane emissions from ruminants, Ministry for Primary Industries, 166 p., 2014. hal-02798728

**HAL Id: hal-02798728**

**<https://hal.inrae.fr/hal-02798728>**

Submitted on 5 Jun 2020

**HAL** is a multi-disciplinary open access archive for the deposit and dissemination of scientific research documents, whether they are published or not. The documents may come from teaching and research institutions in France or abroad, or from public or private research centers.

L'archive ouverte pluridisciplinaire **HAL**, est destinée au dépôt et à la diffusion de documents scientifiques de niveau recherche, publiés ou non, émanant des établissements d'enseignement et de recherche français ou étrangers, des laboratoires publics ou privés.

# Guidelines for use of sulphur hexafluoride (SF<sub>6</sub>) tracer technique to measure enteric methane emissions from ruminants

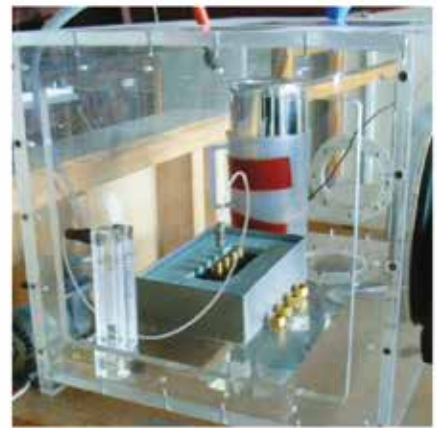

April 2014

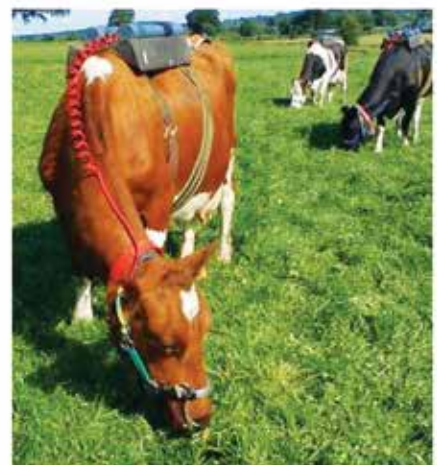

## Acknowledgements

These has been commissioned by the New Zealand Government to support the goals and objectives of the Global Research Alliance on Agricultural Greenhouse Gases. The contents are the collated work of individual scientists in Alliance member countries. The contributions from these scientists, their institutions, and funding agencies are gratefully acknowledged, and warm thanks extended for their contribution to this document.

The contributions by M.H. Deighton, P.J. Moate, B.E. Ribaux and S.R.O. Williams were made possible by financial support from the Department of Primary Industries – Victoria, Dairy Australia, Meat and Livestock Australia, and the Australian Government Department of Environment and Primary Industries under its National Livestock Methane Program (NLMP).

Cover image photo credits (clockwise from left):

1 Embrapa, Brazil; 2&5 DEPI, Australia; 3 NIWA, New Zealand; 4 Teagasc, Ireland.

## Publisher details

Ministry for Primary Industries  
Pastoral House, 25 The Terrace  
PO Box 2526, Wellington 6140, New Zealand  
Tel: +64 4 894 0100 or 0800 00 83 33  
Web: [www.mpi.govt.nz](http://www.mpi.govt.nz)

Copies can be downloaded in a printable pdf format from <http://www.globalresearchalliance.org>

The document and material contained within will be free to download and reproduce for educational or non-commercial purposes without any prior written permission from the authors of the individual chapters. Authors must be duly acknowledged and material fully referenced. Reproduction of the material for commercial or other reasons is strictly prohibited without the permission of the authors.

ISBN No: 978-0-478-43210-7 (online)

ISBN No. 978-0-478-43211-4 (print)

## Referencing & citation

The correct referencing of this publication is: Berndt, A., T. M. Boland, M. H. Deighton, J. I. Gere, C. Grainger, R. S. Hegarty, A. D. Iwaasa, J. P. Koolgaard, K. R. Lassey, D. Luo, R. J. Martin, C. Martin, P. J. Moate, G. Molano, C. Pinares-Patiño, B. E. Ribaux, N. M. Swainson, G. C. Waghorn, and S. R. O. Williams. 2014. Guidelines for use of sulphur hexafluoride (SF<sub>6</sub>) tracer technique to measure enteric methane emissions from ruminants. Pages 166. M. G. Lambert, ed. New Zealand Agricultural Greenhouse Gas Research Centre, New Zealand.

## Disclaimer

While every effort has been made to ensure the information in this publication is accurate, the Livestock Research Group of the Global Research Alliance on Agricultural Greenhouse Gases does not accept any responsibility or liability for error of fact, omission, interpretation or opinion that may be present, nor for the consequences of any decisions based on this information. Any view or opinion expressed does not necessarily represent the view of the Livestock Research Group of the Global Research Alliance on Agricultural Greenhouse Gases.

## Editors

M G Lambert

[Greg.lambert@clear.net.nz](mailto:Greg.lambert@clear.net.nz)

## International Author Team

A Berndt	Embrapa, Rod. Washington Luiz, km 234, Fazenda Canchim, 13560970 - São Carlos, SP - Brasil - Caixa-postal: 339, Brazil	<a href="mailto:alberndt@cppse.embrapa.br">alberndt@cppse.embrapa.br</a>
T Boland	School Of Agriculture & Food Science, Agriculture and Food Science Centre, University College Dublin, Belfield, Dublin 4, Ireland	<a href="mailto:tommy.boland@ucd.ie">tommy.boland@ucd.ie</a>
M H Deighton	Department of Environment and Primary Industries, 1301 Hazeldean Rd, Ellinbank, Victoria 3821, Australia	<a href="mailto:matthew.deighton@depi.vic.gov.au">matthew.deighton@depi.vic.gov.au</a>
J I Gere	La Universidad Nacional del Centro de la Provincia de Buenos Aires, Gral., Pinto 399, C.P. B7000GHG, Tandil Bs. As., Argentina	<a href="mailto:jgere@exa.unicen.edu.ar">jgere@exa.unicen.edu.ar</a>
C Grainger		<a href="mailto:chrisgraingercq@gmail.com">chrisgraingercq@gmail.com</a>
R S Hegarty	School of Environmental and Rural Science, University of New England, Armidale NSW 2351, Australia	<a href="mailto:rhgart3@une.edu.au">rhgart3@une.edu.au</a>
A D Iwaasa	Agriculture and Agri-Food Canada/Agriculture et Agroalimentaire Canada - Semiarid Prairie, Agricultural Research Centre, Box 1030, Swift Current, Saskatchewan, S9H 3X2, Canada	<a href="mailto:Alan.Iwaasa@AGR.GC.CA">Alan.Iwaasa@AGR.GC.CA</a>
J P Koolaard	AgResearch Limited, Private Bag 11008, Palmerston North 4442, New Zealand	<a href="mailto:John.Koolaard@agresearch.co.nz">John.Koolaard@agresearch.co.nz</a>
K R Lassey	Lassey Research & Education Ltd, 4 Witako St, Lower Hutt 5011, New Zealand	<a href="mailto:keith@lasseyresearch.co.nz">keith@lasseyresearch.co.nz</a>
D Luo	AgResearch Limited, Private Bag 11008, Palmerston North 4442, New Zealand	<a href="mailto:Dongwen.Luo@agresearch.co.nz">Dongwen.Luo@agresearch.co.nz</a>
R J Martin	National Institute of Water and Atmospheric Research, Private Bag 14901, Wellington, New Zealand	<a href="mailto:Ross.Martin@niwa.co.nz">Ross.Martin@niwa.co.nz</a>
C Martin	A: INRA A INRA, UMR1213 Herbivores, F-63122 Saint-Genès-Champanelle, France; B: Clermont Université, VetAgro Sup, UMR1213 Herbivores, BP 10448, F-63000, Clermont-Ferrand, France	<a href="mailto:cecile.martin@clermont.inra.fr">cecile.martin@clermont.inra.fr</a>
P J Moate	Department of Environment and Primary Industries, 1301 Hazeldean Rd, Ellinbank, Victoria 3821, Australia	<a href="mailto:peter.moate@dpi.vic.gov.au">peter.moate@dpi.vic.gov.au</a>
G Molano	AgResearch Limited, Private Bag 11008, Palmerston North 4442, New Zealand	<a href="mailto:german.molano@agresearch.co.nz">german.molano@agresearch.co.nz</a>
C Pinares-Patiño	AgResearch Limited, Private Bag 11008, Palmerston North 4442, New Zealand	<a href="mailto:cesar.pinares@agresearch.co.nz">cesar.pinares@agresearch.co.nz</a>
B E Ribaux	Department of Environment and Primary Industries, 1301 Hazeldean Rd, Ellinbank, Victoria 3821, Australia	<a href="mailto:brigid.ribaux@depi.vic.gov.au">brigid.ribaux@depi.vic.gov.au</a>
N M Swainson		<a href="mailto:natashaswainson@gmail.com">natashaswainson@gmail.com</a>
G C Waghorn	DairyNZ, Private Bag 3221, Hamilton 3240, New Zealand	<a href="mailto:garry.waghorn@dairynz.co.nz">garry.waghorn@dairynz.co.nz</a>
S R O Williams	Department of Environment and Primary Industries, 1301 Hazeldean Rd, Ellinbank, Victoria 3821, Australia	<a href="mailto:richard.williams@depi.vic.gov.au">richard.williams@depi.vic.gov.au</a>

## Table of Contents

	Editors .....	3
	International Author Team .....	3
	Table of Contents .....	4
	Figures and Tables.....	7
	Equations.....	10
1	Introduction .....	11
	1.1 References .....	13
2	Overview of the SF <sub>6</sub> tracer technique and its evolution.....	16
	2.1 Evolution.....	16
	2.2 The SF <sub>6</sub> tracer technique in brief .....	17
	2.3 Subsidiary feed measurements .....	18
	2.4 Summary of fundamentals of the SF <sub>6</sub> tracer technique .....	19
	2.5 References .....	19
3	Pre-experimental planning – how many animals are needed? .....	22
	3.1 Pre-experimental planning .....	22
	3.2 Analysis of SF <sub>6</sub> data.....	25
	3.3 References .....	26
4	Permeation tubes: the source of SF <sub>6</sub> .....	27
	4.1 Tube design and properties.....	27
	4.2 Tube filling .....	32
	4.3 Tube calibration.....	35
	4.4 Tube performance .....	39
	4.5 References .....	46
5	Sampling systems.....	49
	5.1 Sampling location .....	50
	5.2 Configuration of sampling apparatus.....	53
	5.3 Sample collection procedure.....	62
	5.4 Conclusion .....	72
	5.5 References .....	73
6	Special considerations for ruminally-cannulated animals .....	75
	6.1 Advantages of the SF <sub>6</sub> tracer technique .....	75
	6.2 Limitations and concerns.....	76
	6.3 Rumen headspace gas sampling.....	77
	6.4 References .....	79

7	Sampling background air .....	81
7.1	Apparatus .....	81
7.2	Outdoors.....	82
7.3	Indoors.....	84
7.4	Mixed accommodation.....	87
7.5	Conclusion .....	88
7.6	References .....	88
8	Analyses of breath samples .....	89
8.1	Sample extraction.....	89
8.2	Analysis by gas chromatography.....	92
8.3	Analysis by other technologies.....	105
8.4	Intermediate sample storage .....	107
8.5	References .....	112
9	Animal management and feed intake.....	114
9.1	Animal handling and management .....	116
9.2	Determining feed intake.....	118
9.3	Expressing methane and measuring diet composition .....	123
9.4	References .....	124
10	Estimating methane emission rates and methane yield using the SF <sub>6</sub> technique .....	126
10.1	Basic theory .....	126
10.2	Choice of Breath Sample Integration Period.....	128
10.3	Uncertainty and variability in CH <sub>4</sub> emissions estimates .....	129
10.4	Metric of measurement .....	130
10.5	References .....	131
11	Data quality assurance and quality control .....	134
11.1	Problems with calibrated permeation rates of SF <sub>6</sub> and range of permeation rates .....	134
11.2	Background concentrations of tracer and trace gases.....	135
11.3	Sample quality assessment at collection and further processing .....	138
11.4	Steps to detect anomalous concentrations of gases in the samples .....	138
11.5	Screening for outlier data.....	140
11.6	Conclusion .....	143
11.7	References .....	144
12	SF <sub>6</sub> Reporting .....	146
12.1	Permeation tubes .....	146
12.2	Animal accommodation .....	147

12.3	Breath samples .....	148
12.4	Background samplers .....	148
12.5	Sample preparation .....	149
12.6	Sample analysis.....	149
12.7	Methane calculation.....	150
12.8	Data analysis.....	151
12.9	References .....	151
13	Bibliography .....	153

## Figures and Tables

Table 3.1: Likelihood (%), of detecting a significant difference (at P < 0.05) between the means of two groups of animals – either 1.5, 1 or 0.5 within animal standard deviations (SD) apart – with a set number of animals per group, and a set number of consecutive measurements. This is for CH <sub>4</sub> yield estimated using the SF <sub>6</sub> technique. ....	24
Table 3.2: Total number of experimental animals required to detect a significant difference in mean estimated CH <sub>4</sub> yield (g CH <sub>4</sub> /kg DMI) between two groups of animals with a specified coefficient of variation (CV) and expected difference between treatment means when using the SF <sub>6</sub> tracer technique. ....	25
Figure 4.1: An exploded view of NIWA permeation tubes (Lassey et al., 2001) of which there are two sizes; sheep tubes and cattle tubes (Table 4.1). ....	29
Table 4.1: Representative properties of NIWA permeation tubes. ....	30
Figure 4.2: Engineering diagram for a high flow permeation tube used to deliver SF <sub>6</sub> or other tracer gases (Hegarty et al., 2003). ....	32
Figure 4.3: The NIWA facility for charging permeation tubes with SF <sub>6</sub> . ....	33
Figure 4.4: A Sartorius CP224S electronic balance as used to weigh permeation tubes at Department of Environment and Primary Industries, Ellinbank, Victoria, Australia. ....	36
Figure 4.5: Sheep tube #387 filled at NIWA, New Zealand, on 26 Jun 2001 was one of six 'left-over' tubes retained for a longevity experiment from a batch of 40 tube fills. ....	39
Figure 4.6: Release rate profile (mgSF <sub>6</sub> /d) for three high flow rate permeation tubes from which data on days 6–12 were used to estimate release rates. ....	43
Figure 5.1: Examples of sampling points for the collection of air samples. ....	50
Table 5.1: A summary of the characteristics of various established sampling systems for use with cattle. ....	51
Figure 5.2: Sampling apparatus used at various research locations internationally. ....	52
Figure 5.3: Air filter, flow restricting capillary tube and quick connect stem assembly used at the Department of Environment and Primary Industries, Victoria, Australia. ....	53
Figure 5.4: A 0.8 L stainless steel collection vessel used at the Department of Environment and Primary Industries, Victoria, Australia. ....	54
Figure 5.5: Sample collection apparatus used at the Agriculture and Agri-Food Canada, Semiarid Prairie Agricultural Research Centre. ....	54
Figure 5.6: QC4 Quick Connect components; stem (left) and body (Swagelok, Solon, OH, USA) ....	56
Figure 5.7: The parts of a QC4 quick connect body (Swagelok, Solon, OH, USA). ....	56
Figure 5.8: Capillary tube ....	57
Figure 5.9: Crimped capillary ....	57
Figure 5.10: Ball bearing. ....	57
Figure 5.11: A flow meter must be on the atmospheric side of the restrictor when measuring flow. ....	58
Figure 5.12: Coiled capillary can be housed inside a PVC tube for protection ....	60
Figure 5.13: A 15mm length of 1.59 mm crimped capillary tube (a) fitted inside a Swagelok air filter (b) and 1/8" tube using nut and ferrule tube connections (Swagelok, Solon, OH, USA). ....	60



Figure 5.14: Various canister mounting positions.....	61
Figure 5.15: Two types of back-mounting system for collection vessels.....	62
Figure 5.16: A single evacuation of a collection vessel can leave a residue in proportion to the concentration of gases in the previous sample - from Deighton et al. (2011). .....	63
Figure 5.17: Flow rate through crimped capillaries declines with decline of vacuum in the collection vessel. Dotted line indicates ~27% flow reduction at 50 kPa; the point at which collection is commonly terminated with capillary sampling systems. (Empirical data from Department of Primary Industries, Victoria, Australia). .....	65
Figure 5.18: CH <sub>4</sub> peaks at feeding, then declines when dairy cows are fed twice per day (Empirical respiration chamber data from Department of Environment and Primary Industries, Victoria, Australia, arrows indicate feeding times). .....	66
Figure 5.19: A schematic of the Lung-GC system (Martin et al., 2011), showing one of three layers of the Lung (shaded) connecting to one of three inlets represented by three sheep. ....	72
Figure 6.1: Apparatus for rumen headspace gas sampling (Jouany and Senaud, 1979). .....	77
Figure 6.2: Post feeding kinetics of gas concentration ratios and estimated hourly productions of CH <sub>4</sub> and CO <sub>2</sub> , based on gases sampled from the rumen headspace with low (LRR, ○) and high (HRR, ■) release rates of SF <sub>6</sub> . .....	78
Figure 7.1: Example equipment used to collect samples of background air at the Department of Environment and Primary Industries, Victoria, Australia.....	82
Figure 7.2: A theoretical arrangement of animals in an outdoor area and potential fixed sites for sampling background air (numbered). .....	83
Figure 7.3: Equipment for sampling the background air can be hung on a fence. ....	84
Figure 7.4: Sampling the background air at many locations is necessary to determine the most representative. ....	85
Figure 7.5: Example concentrations of CH <sub>4</sub> and SF <sub>6</sub> with cow position along a single row of stalls and sentinel positions for sampling of background air at Department of Environment and Primary Industries, Victoria, Australia. ....	86
Figure 8.1: Schematic configuration of the two-column GC configuration, as implemented at NIWA and reported by Lassey et al. (2011). .....	93
Figure 8.2: Representative chromatograms for a background sample (upper panel) and for a breath sample (lower panel), as determined and presented by ChemStation®.....	94
Figure 8.3: Relationships between ECD detector response to SF <sub>6</sub> (chromatogram peak area) in the eluting gas to SF <sub>6</sub> mixing ratio, [SF <sub>6</sub> ], in a detailed calibration experiment conducted in December 2003 as a NIWA-AgResearch collaboration (New Zealand).....	100
Figure 8.4: GC and copper tube array used to bring the temperature of the carrier gas to room temperature. At DPI Ellinbank, bottled gas is stored outside buildings for safety. In cold weather, it had been observed that the chromatogram baselines were unstable when the carrier gas was piped directly to the GC without temperature stabilisation.....	102
Figure 8.5: A typical linear GC calibration equation for SF <sub>6</sub> as determined at DPI Ellinbank. The three points or clusters, other than the origin, correspond to three standards. ....	103
Figure 8.6: A typical DPI Ellinbank GC/ECD chromatogram, showing the SF <sub>6</sub> peak. ....	104
Figure 8.7: A typical DPI Ellinbank GC/FID chromatogram, showing the CH <sub>4</sub> peak.....	104

Figure 8.8: Concentrations of SF <sub>6</sub> measured in background air samples at Department of Primary Industries, Victoria, Australia (●; line shows linear trend) and atmospheric air samples at Cape Grim Baseline Air Pollution Station (○) located at Northwest Tasmania (40° 41' S, 144° 41' E). Cape Grim data courtesy Paul Krummel (CSIRO Division of Marine and Atmospheric Research – Aspendale, Australia).....	105
Figure 8.9: The Embrapa (Brazil) system for transferring samples from collection canister to 20 ml vials.....	111
Table 9.1: Positive and negative aspects of intake measurement from housed, grazed and estimated values. ....	120
Figure 11.1: Concentrations of SF <sub>6</sub> in breath sample and in the background air (expressed as a percentage of the concentration in breath) found during an experiment at INRA Clermont-Ferrand (France) (Yvonne Rochette, unpublished data).....	137
Figure 11.2: Net concentrations of CH <sub>4</sub> and CO <sub>2</sub> in gases collected using SF <sub>6</sub> sample collection apparatus over five consecutive days from beef and dairy cattle grazing tropical forages (Source: PECUS Project, EMBRAPA, Brazil). ....	140
Table 11.1: Screening of 'Normalised PR of SF <sub>6</sub> ' for outliers. Breath samples collected from 28 grazing cattle. ....	142
Table 11.2: Screening of 'CH <sub>4</sub> /SF <sub>6</sub> ratio' for outliers. Breath samples collected from 28 grazing cattle.....	143

## Equations

Eqn 2. 1.....	18
Eqn 4. 1.....	40
Eqn 4.2.....	42
Eqn 4.3.....	44
Eqn 4.4.....	45
Eqn 7. 1.....	86
Eqn 7. 2.....	88
Eqn 8. 1.....	97
Eqn 8. 2.....	97
Eqn 8. 3.....	97
Eqn 8. 4.....	98
Eqn 8. 5.....	104
Eqn 10. 1.....	126
Eqn 10. 2.....	127
Eqn 10. 3.....	128
Eqn 10. 4.....	130
Eqn 12. 1.....	150

# 1 INTRODUCTION

K.R. Lassey<sup>a\*</sup>

<sup>a</sup>Lassey Research & Education Ltd, Lower Hutt, New Zealand

\*Corresponding Author: K.R. Lassey, Email: [keith.lassey@lasseyresearch.co.nz](mailto:keith.lassey@lasseyresearch.co.nz)

---

Methane (CH<sub>4</sub>) is the most abundant hydrocarbon in the atmosphere. Over the past three centuries of unprecedented agricultural and industrial activity, methane concentrations have grown from about 0.7 ppm in 1700AD to present-day levels of about 1.8 ppm (Dlugokencky et al., 2011, MacFarling Meure et al., 2006) (1 ppm = 1 μmol(CH<sub>4</sub>) per mol of dried air). Research into the global CH<sub>4</sub> budget – the balance between atmospheric burden, global sources and atmospheric removals – leaves no doubt that this increase is due to rising emissions from human activities (anthropogenic sources), despite uncertainties around apportioning them to specific sources (Denman et al., 2007, Dlugokencky et al., 2011, Kirschke et al., 2013, Prather et al., 2012).

Arguably, CH<sub>4</sub> emitted by farmed ruminant livestock is both the largest anthropogenic category of global CH<sub>4</sub> sources, and among the most certain (Lassey, 2007, Lassey, 2008). Best estimates of the global budget suggest the present atmospheric CH<sub>4</sub> burden of about 5000 Tg (1 Tg = 10<sup>12</sup> g) is sustained by a global source of 554 ± 56 Tg/yr (mean ± 1 s.d.), with mean atmospheric residence time of about 9.1 ± 0.9 yr (Prather et al., 2012). Of that global source, 202 ± 35 Tg/yr (~40%) has natural origins – mainly from wetlands – while the remaining 352 ± 45 Tg/yr is anthropogenic (Prather et al., 2012). Farmed ruminant livestock account for between 76 and 92 Tg/yr – about 15% of the global source, or some 25% of the anthropogenic source.

Such 'ruminant CH<sub>4</sub>' emissions can dominate the national CH<sub>4</sub> emission inventories of some heavily agricultural nations. They may even be a dominant constituent of total greenhouse gas emissions, as they are in New Zealand, where ruminant CH<sub>4</sub> accounts for 90% of anthropogenic CH<sub>4</sub> emissions and one third of all CO<sub>2</sub>-equivalent greenhouse gas emissions. Several Latin American countries have similar profiles.

Methane emissions are inextricably linked to food production (rice cultivation as well as livestock production) and therefore to food security. The interaction between agriculture and climate – including agriculture's role in greenhouse gas production, and sustainable agricultural practices – has attracted scrutiny (McAllister et al., 2011, O'Mara, 2011, Salinger, 2007, Steinfeld et al., 2006). Some countries regard agricultural emissions as candidates for emission abatement, to partly meet obligations under international treaties such as the Kyoto Protocol. That stance requires that agricultural emissions be measurable – you can't be confident of reducing what you can't measure accurately. This measurement challenge has spawned two reliable techniques for estimating CH<sub>4</sub> emission from individual animals: enclosure techniques and the SF<sub>6</sub> tracer technique. Enclosure techniques allow for

estimation of emissions from all enclosed orifices, while the SF<sub>6</sub> tracer technique determines emissions only via the nasal cavity.

Enclosure techniques have been used in studies of ruminant metabolism for many decades. The most common form is open-circuit chambers, where controlled airflow is monitored for composition at inlet and outlet using instruments such as infrared analysers. While this requires that acclimatised animals be confined in unnatural conditions, CH<sub>4</sub> emissions can be inferred with high precision. See Johnson and Johnson (1995) for an overview, Grainger et al. (2007) and McGinn et al. (2006) for descriptions of particular facilities.

The SF<sub>6</sub> tracer technique relies on a known source of a synthetic inert tracer – sulphur hexafluoride (SF<sub>6</sub>) – inserted in the rumen, where at least 90% of CH<sub>4</sub> is sourced. ‘Breath’, characterised as respired plus eructed gases, is sampled and analysed (Chapter 2). This technique can be used with untethered, freely-grazing animals. Moreover, the equipment cost per animal under test is much lower than for chamber experiments, enabling dozens or even hundreds of animals to be breath-tested in a single experiment (e.g. (McNaughton et al., 2005).

Several experimenters have compared enclosure and SF<sub>6</sub> tracer techniques ((Boadi et al., 2002, Grainger et al., 2007, McGinn et al., 2006, Muñoz et al., 2012, Pinares-Patiño et al., 2008, Pinares-Patiño et al., 2011), and those comparisons are generally favourable. However, emission estimates by the SF<sub>6</sub> tracer technique appear subject to greater variability than those from enclosure techniques. On the one hand this may suggest that the SF<sub>6</sub> tracer technique superimposes its own inherent variability on natural biological variability, or that the technique is not always applied with sufficient attention to detail. On the other hand, the SF<sub>6</sub> tracer technique may be capturing real variability of animal intake and behaviour that is masked in chambers, where intake and behaviour is more controlled.

The SF<sub>6</sub> tracer technique enjoys wide acceptance, but with a variety of implementations. This variety arises from different equipment and hardware designs, and variations in innovative hardware developments, as well as differences in experimental protocols and data analysis. These guidelines are the culmination of a project to bring experienced SF<sub>6</sub> practitioners together, and to pool those experiences into a composite guide. The first stage of that project was a workshop – held in Palmerston North, New Zealand, in March 2011 and chaired by Keith Lassey, then of NIWA – featuring international practitioners skilled in a range of SF<sub>6</sub> applications. An outline of these guidelines and an allocation of authorships are outputs from that workshop.

These guidelines are offered as a comprehensive, citable, peer-reviewed reference to the theory and practice of the SF<sub>6</sub> tracer technique. It presents the combined expertise and experience of leading practitioners from around the world. The guidelines recommend standard and/or best practice approaches without being prescriptive: a recognition that the approach chosen will reflect the particular circumstances of the experiment, such as the availability of skills and equipment, or the nature of the national livestock industry.

These guidelines are written to help researchers:

- understand the fundamental principles behind the SF<sub>6</sub> tracer technique, and the concepts around its effective use.
- with minimal experience of the technique who wish to get up and running as quickly as possible (aided by the technical manual by Johnson et al. (2007)).
- decide on an implementation, or adapt an existing implementation, to suit their circumstances (access to skilled personnel or laboratories, etc).
- cite a specific implementation, and credit its developer(s), rather than having to detail that implementation in a paper.
- tap into the collective wisdom of researchers experienced in applying and/or adapting the technique.

## 1.1 References

Boadi, D.A., K.M. Wittenberg, and A.D. Kennedy. 2002. Validation of the sulphur hexafluoride (SF<sub>6</sub>) tracer gas technique for measurement of methane and carbon dioxide production by cattle. *Can. J. of Anim. Sci.* 82(2):125-131.

Denman, K.L., G. Brasseur, A. Chidthaisong, P. Ciais, P.M. Cox, R.E. Dickinson, D. Hauglustaine, C. Heinze, E. Holland, D. Jacob, U. Lohmann, S. Ramachandran, P. L. da Silva Dias, W.S.C, and X. Zhang. 2007. Couplings Between Changes in the Climate System and Biogeochemistry. in *Climate Change 2007: The Physical Science Basis. Contribution of Working Group I to the Fourth Assessment Report of the Intergovernmental Panel on Climate Change. Vol. 7.* S. Solomon, D. Qin, M. Manning, Z. Chen, M. Marquis, K. B. Averyt, T. M, and H. L. Miller, ed.

Dlugokencky, E.J., E.G. Nisbet, R. Fisher, and D. Lowry. 2011. Global atmospheric methane: budget, changes and dangers. *Philosophical Transactions of the Royal Society A: Mathematical, Physical and Engineering Sciences* 369(1943):2058-2072.

Grainger, C., T. Clarke, S. M. McGinn, M. J. Auld, K. A. Beauchemin, M. C. Hannah, G. C. Waghorn, H. Clark, and R. J. Eckard. 2007. Methane emissions from dairy cows measured using the sulfur hexafluoride (SF<sub>6</sub>) tracer and chamber techniques. *J. Dairy Sci.* 90(6):2755-2766.

Johnson, K. A. and D. E. Johnson. 1995. Methane emissions from cattle. *J. of Anim. Sci.* 73(8):2483-2492.

Johnson, K. A., H. H. Westberg, J. J. Michal, and M. W. Cossalman. 2007. The SF<sub>6</sub> tracer technique: Methane measurement from ruminants. Pages 33-67. Springer Netherlands.

Kirschke, S., P. Bousquet, P. Ciais, M. Saunois, J. G. Canadell, E. J. Dlugokencky, P. Bergamaschi, D. Bergmann, D. R. Blake, and L. Bruhwiler. 2013. Three decades of global methane sources and sinks. *Nature Geoscience* 6(10):813-823.

Lassey, K. R. 2007. Livestock methane emission: From the individual grazing animal through national inventories to the global methane cycle. *Agri. Forest Meteorology* 142(2):120-132.

Lassey, K. R. 2008. Livestock methane emission and its perspective in the global methane cycle. *Aust. J. Exp. Agri.* 48(1-2):114-118.

MacFarling Meure, C., D. Etheridge, C. Trudinger, P. Steele, R. Langenfelds, T. Van Ommen, A. Smith, and J. Elkins. 2006. Law Dome CO<sub>2</sub>, CH<sub>4</sub> and N<sub>2</sub>O ice core records extended to 2000 years BP. *Geophysical Research Letters* 33(14).

McAllister, T. A., K. A. Beauchemin, S. M. McGinn, X. Hao, and P. Robinson. 2011. Greenhouse gases in animal agriculture—Finding a balance between food production and emissions. *Anim. Feed Sci. Tech.* 166:1-6.

McGinn, S. M., K. A. Beauchemin, A. D. Iwaasa, and T. A. McAllister. 2006. Assessment of the sulfur hexafluoride (SF<sub>6</sub>) tracer technique for measuring enteric methane emissions from cattle. *J. Environ. Quality* 35(5):1686-1691.

McNaughton, L., D. Berry, H. Clark, C. Pinares-Patiño, S. Harcourt, and R. Spelman. 2005. Factors affecting methane production in Friesian x Jersey dairy cattle. Pages 352-355 in Proc. New Zealand Society of Animal Production 2005. New Zealand Society of Animal Production.

Muñoz, C., T. Yan, D. A. Wills, S. Murray, and A. W. Gordon. 2012. Comparison of the sulfur hexafluoride tracer and respiration chamber techniques for estimating methane emissions and correction for rectum methane output from dairy cows. *J. Dairy Sci.* 95(6):3139-3148.

O'Mara, F. P. 2011. The significance of livestock as a contributor to global greenhouse gas emissions today and in the near future. *Anim. Feed Sci. Tech.* 166:7-15.

Pinares-Patiño, C. S., C. W. Holmes, K. R. Lassey, and M. J. Ulyatt. 2008. Measurement of methane emission from sheep by the sulphur hexafluoride tracer technique and by the calorimetric chamber: Failure and success. *Animal* 2(1):141-148.

Pinares-Patiño, C. S., K.R. Lassey, R. J. Martin, G. Molano, M. Fernandez, S. MacLean, E. Sandoval, D. Luo, and H. Clark. 2011. Assessment of the sulphur hexafluoride (SF<sub>6</sub>) tracer technique using respiration chambers for estimation of methane emissions from sheep. *Anim. Feed Sci. Tech.* 166-167:201-209.

Prather, M. J., C.D. Holmes, and J. Hsu. 2012. Reactive greenhouse gas scenarios: Systematic exploration of uncertainties and the role of atmospheric chemistry. *Geophysical Research Letters* 39(9).

Salinger, M. J. 2007. Agriculture's influence on climate during the Holocene. *Agric. Forest Meteorology* 142(2):96-102.

Steinfeld, H., P. Gerber, T. Wassenaar, V. Castel, M. Rosales, and C. d. Haan. 2006. Livestock's Long Shadow: Environmental Issues and Options. Food and Agriculture Organization of the United Nations (FAO), Rome, Italy.



## 2 OVERVIEW OF THE SF<sub>6</sub> TRACER TECHNIQUE AND ITS EVOLUTION

K.R. Lassey<sup>a\*</sup> & R.S. Hegarty<sup>b</sup>

<sup>a</sup>Lassey Research & Education Ltd, Lower Hutt, New Zealand

<sup>b</sup>School of Environmental and Rural Science, University of New England, Armidale NSW, Australia

\*Corresponding Author: K. R. Lassey, Email: [keith.lassey@lasseyresearch.co.nz](mailto:keith.lassey@lasseyresearch.co.nz)

---

### 2.1 Evolution

Sulphur hexafluoride (SF<sub>6</sub>) is a gas at standard temperature and pressure, where it is also chemically and biologically inert ([http://en.wikipedia.org/wiki/Sulfur\\_hexafluoride](http://en.wikipedia.org/wiki/Sulfur_hexafluoride)). It has no known natural sources, and is manufactured largely for use as an insulating gas in electrical switchgear. It has a very low concentration in the background atmosphere; about seven parts per trillion (ppt, defined as pmol per mol dry air) though growing (Rigby et al., 2010) as a result of human activities (see also Chapter 7). As a fully halogenated gas, SF<sub>6</sub> is quantitatively detectable at ppt levels in air, using electron capture detection (ECD) with a gas chromatograph (Clemons and Altshuller, 1966, Lovelock, 1971).

These properties have made SF<sub>6</sub> a tracer of choice in air-dispersion experiments and indoor ventilation studies over several decades (Clemons et al., 1968, Eskridge et al., 1979). Its low but detectable concentration in water makes it an ideal water-borne tracer, with uses such as investigating gas exchange across the air-water interface (Wanninkhof et al., 1985), or mapping currents (Clark et al., 1996).

Thus, when Zimmerman of the National Center for Atmospheric Research at Boulder, Colorado, first recommended SF<sub>6</sub> as a tracer of ruminant CH<sub>4</sub> in 1993 (Zimmerman, 1993), there was already a lot of experience with that tracer. A research team at Washington State University in Pullman, comprising experts in trace gas handling and analysis and in animal nutrition worked with Zimmerman to further develop the SF<sub>6</sub> tracer technique as a tool to quantify bovine ruminant CH<sub>4</sub> emissions, and published the seminal paper (Johnson et al., 1994).

That technique has since been adopted across the globe. It has been adapted to measure emissions from sheep (Lassey et al., 1997), alpacas (Pinares-Patiño et al., 2003) and deer (Swainson et al., 2011), and while it cannot account for small losses of CH<sub>4</sub> in flatus, emission estimates using the technique compares favourably with those using respiration headboxes and chambers (Boadi et al., 2002, Grainger et al., 2007, McGinn et al., 2006, Muñoz et al., 2012, Pinares-Patiño et al., 2008, Pinares-Patiño et

al., 2011), if with greater variability (Grainger et al., 2007, McGinn et al., 2006, Pinares-Patiño and Clark, 2008, Pinares-Patiño et al., 2011).

As noted in Chapter 1, such enhanced variability could either originate from the technique as implemented, or reflect a genuine biological variability that is less pronounced in the controlled management of chambers.

As a cautionary note, SF<sub>6</sub> is a powerful greenhouse gas: an emission of one kilogram of SF<sub>6</sub> into the atmosphere is deemed equivalent to an emission of 22,800 kg of CO<sub>2</sub> (Table 2.14 in Forster et al. (2007)). This gas should therefore be used responsibly, with all reasonable efforts to minimise SF<sub>6</sub> losses and waste.

## 2.2 The SF<sub>6</sub> tracer technique in brief

The SF<sub>6</sub> tracer technique works on the basis that excretions of two gases sourced from the rumen disperse identically into the animal's environment, and thus have identical probability of interception by a 'breath' sampler located near the nasal cavity. One of those gases is the purposeful tracer, SF<sub>6</sub>, which has a known release rate, while the release rate of the other – CH<sub>4</sub> – is under investigation. Thus, the concentration ratio of those gases in a breath sample, accumulated over a feeding cycle, can be equated to the ratio of their release rates, with due allowance for the presence of SF<sub>6</sub> and CH<sub>4</sub> in 'background' air (Chapter 7). This enables the unknown CH<sub>4</sub> release rate to be estimated. One can think of the tracer as allowing the efficiency of breath interception to be quantified.

Importantly, the ideal tracer should be conservative (all *in vivo* removal pathways and fates quantitatively identified), biologically inert (demonstrated for SF<sub>6</sub> by Johnson et al. (1994)), be co-released with CH<sub>4</sub> in the rumen, and behave as similarly to CH<sub>4</sub> as possible after release. Thus, eructation of the two gases into breath would then be 100% correlated; an idealisation not expected on timescales shorter than a full feeding cycle.

A known source of SF<sub>6</sub> – a permeation tube loaded cryogenically with SF<sub>6</sub> and with a calibrated SF<sub>6</sub> release rate,  $Q_{SF_6}$ , (Chapter 4) – is inserted into the rumen of each participating animal prior to the experiment. A pre-evacuated canister draws air from near the animal's nasal cavity at a steady rate. The canister is carried by grazing animals, so it should be light and unobtrusive, made from pressure-rated PVC tubing, aluminium, or stainless steel (Chapter 5). Johnson et al. (2007) have published detailed, illustrated descriptions of typical experimental equipment, along with its fabrication and deployment.

A breath sample is usually accumulated over 24 hours (i.e., a full feeding cycle), and collections typically repeated over five to eight days through canister exchange. Some experiments have used shorter breath accumulations, because of experimental constraint (Martin et al., 2012) or to test the influence of accumulation time (Lassey et al., 2011), and some experiments have used lower collection rates to achieve multi-day accumulations (Pinares-Patiño et al., 2012) that might be appropriate when animal

management requires infrequent mustering. Sampling equipment is therefore designed so canisters can be replaced easily.

A sub-sample of gas from each canister is analysed for CH<sub>4</sub> and SF<sub>6</sub>, usually using gas chromatography (Chapter 8). Mixing ratios of CH<sub>4</sub> and SF<sub>6</sub> in breath samples and background are then combined to provide an estimate of CH<sub>4</sub> emission rate over the breath-collection period for the particular animal. In its simplest form, this CH<sub>4</sub> emission rate estimate,  $Q_{CH_4}$ , is given by:

$$Q_{CH_4} = Q_{SF_6} \times [CH_4] / [SF_6] \quad \text{Eqn 2.1}$$

where  $Q_{SF_6}$  is the particular SF<sub>6</sub> release rate, and  $[CH_4]/[SF_6]$  is the ratio of trace gas mixing ratios in breath adjusted for background levels (Chapter 10). Eqn 2.1 presumes consistent molar units for  $Q_{SF_6}$  and  $Q_{CH_4}$ , with an adjustment factor required for the more usual mass units. Considerations around the deployment of background samplers are addressed in Chapter 7.

Ideally, CH<sub>4</sub> and SF<sub>6</sub> are sourced identically in the rumen, and sampled with equal probability, but in practice, this idealisation cannot be met. While a constant release rate of SF<sub>6</sub> from its source might suggest a constant emission rate at each respiratory or eructation cycle, CH<sub>4</sub> emission rates would strongly peak during rumen digestion. This creates a potential mismatch in the timing of SF<sub>6</sub> and CH<sub>4</sub> emissions, especially when animals are fed distinct meals that lead to emissions peaking in the one to two hours after feeding. In addition, some emitted CH<sub>4</sub> may not be sourced in the rumen. It is therefore important to sample breath over a full feeding cycle – usually 24 hours – to avoid bias.

### 2.3 Subsidiary feed measurements

While measurements of animal characteristics and properties of its feed during the experiment are inessential to the implementation of the SF<sub>6</sub> tracer technique, they are critical to interpretation of the CH<sub>4</sub> emission findings, and valuable for any later meta-analyses.

Because the animal's feed provides the substrate for methanogenesis in the rumen, it has long been recognised that CH<sub>4</sub> production is near-proportional to feed intake. Indeed, IPCC methodologies propose that CH<sub>4</sub> emissions be estimated via a 'CH<sub>4</sub> yield' – the enthalpy of emitted CH<sub>4</sub> as a percentage of the gross energy intake (IPCC, 2006), Chapter 9). The IPCC proposes a narrow range of values for the CH<sub>4</sub> yield of  $6.0 \pm 0.5\%$ .

- Many experiments have tested hypotheses that certain diets or dietary supplements can further reduce CH<sub>4</sub> yield, so it is essential that experiments reporting CH<sub>4</sub> emission rates also report dietary details and estimates of feed intake. Specifically, the dietary quality (digestibility, composition) and the level of intake (daily dry matter intake per head) should be reported, as well as the

physiological state of the animals (breed, gender, age, lactation status, body weight). For further detail, see Chapter 9.

## 2.4 Summary of fundamentals of the SF<sub>6</sub> tracer technique

The fundamental requirements of the SF<sub>6</sub> tracer technique can be summarised as follows:

One calibrated SF<sub>6</sub> permeation tube per animal, preferably plus at least three tubes retained in the calibration environment as 'surveillance control tubes' (Chapter 4).

One continuous breath collection system per animal, and per background sampler, that collects a sample at a constant rate (Chapter 5).

Careful animal management, with adequate air movement or ventilation to minimise re-inhalation of respired gases that could lead to cross-contamination of CH<sub>4</sub> and/or SF<sub>6</sub>.

Gas chromatography system for analysis of CH<sub>4</sub> and SF<sub>6</sub>, with strong QA/QC emphasis (Chapter 8).

Subsidiary measurement of feed intake and feed quality in order to relate CH<sub>4</sub> output to feed input (Chapter 9).

## 2.5 References

Boadi, D. A., K. M. Wittenberg, and A. D. Kennedy. 2002. Validation of the sulphur hexafluoride (SF<sub>6</sub>) tracer gas technique for measurement of methane and carbon dioxide production by cattle. *Can. J. Anim. Sci.* 82(2):125-131.

Clark, J. F., P. Schlosser, M. Stute, and H. J. Simpson. 1996. SF<sub>6</sub>-3He tracer release experiment: A new method of determining longitudinal dispersion coefficients in large rivers. *Environ. Sci. Tech.* 30(5):1527-1532.

Clemons, C. and A. Altshuller. 1966. Responses of Electron-Capture Detector to Halogenated Substances. *Anal. Chem.* 38(1):133-136.

Clemons, C. A., A. I. Coleman, and B. E. Saltzman. 1968. Concentration and ultrasensitive chromatographic determination of sulfur hexafluoride for application to meteorological tracing. *Environ. Sci. Tech.* 2(7):551-556.

Eskridge, R. E., F. S. Binkowski, J. Hunt, T. L. Clark, and K. L. Demerjian. 1979. Highway modeling. Part II: Advection and diffusion of SF<sub>6</sub> tracer gas. *J. Appl. Meteorology* 18(4):401-412.

Forster, P., V. Ramaswamy, P. Artaxo, T. Berntsen, R. Betts, D. W. Fahey, J. Haywood, J. Lean, D. C. Lowe, and G. Myhre. 2007. Changes in atmospheric constituents and in radiative forcing. *Climate Change* 20(7).

Grainger, C., T. Clarke, S. M. McGinn, M. J. Auld, K. A. Beauchemin, M. C. Hannah, G. C. Waghorn, H. Clark, and R. J. Eckard. 2007. Methane emissions from dairy cows measured using the sulfur hexafluoride (SF<sub>6</sub>) tracer and chamber techniques. *J. Dairy Sci.* 90(6):2755-2766.

IPCC. 2006. 2006 IPCC Guidelines for National Greenhouse Gas Inventories. H. S. Eggleston, L. Buendia, K. Miwa, T. Ngara, and K. Tanabe, ed. IGES, Japan, <http://www.ipcc-nggip.iges.or.jp/public/2006gl/index.html>.

Johnson, K., M. Huyler, H. Westberg, B. Lamb, and P. Zimmerman. 1994. Measurement of methane emissions from ruminant livestock using a sulfur hexafluoride tracer technique. *Environ. Sci. Tech.* 28(2):359-362.

Johnson, K. A., H. H. Westberg, J. J. Michal, and M. W. Cossalman. 2007. The SF<sub>6</sub> tracer technique: Methane measurement from ruminants. Pages 33-67. Springer Netherlands.

Lassey, K. R., C. S. Pinares-Patiño, R. J. Martin, G. Molano, and A. M. S. McMillan. 2011. Enteric methane emission rates determined by the SF<sub>6</sub> tracer technique: Temporal patterns and averaging periods. *Anim. Feed Sci. Tech.* 166-167:183-191.

Lassey, K. R., M. J. Ulyatt, R. J. Martin, C. F. Walker, and I. D. Shelton. 1997. Methane emissions measured directly from grazing livestock in New Zealand. *Atmospheric Environment* 31(18):2905-2914.

Lovelock, J. E. 1971. Atmospheric fluorine compounds as indicators of air movements. *Nature* 230:379.

Martin, C., J. Koolgaard, Y. Rochette, H. Clark, J. Jouany, and C. Pinares-Patiño. 2012. Effect of release rate of the SF<sub>6</sub> tracer on methane emission estimates based on ruminal and breath gas samples. *Animal* 6(03):518-525.

McGinn, S. M., K. A. Beauchemin, A. D. Iwaasa, and T. A. McAllister. 2006. Assessment of the sulfur hexafluoride (SF<sub>6</sub>) tracer technique for measuring enteric methane emissions from cattle. *J. Environ. Quality* 35(5):1686-1691.

Muñoz, C., T. Yan, D. A. Wills, S. Murray, and A. W. Gordon. 2012. Comparison of the sulfur hexafluoride tracer and respiration chamber techniques for estimating methane emissions and correction for rectum methane output from dairy cows. *J. Dairy Sci.* 95(6):3139-3148.

Pinares-Patiño, C., J. Gere, K. Williams, R. Gratton, P. Juliarena, G. Molano, S. MacLean, E. Sandoval, G. Taylor, and J. Koolgaard. 2012. Extending the collection duration of breath samples for enteric methane emission estimation using the SF<sub>6</sub> tracer technique. *Animal* 2(2):275-287.

Pinares-Patiño, C. S. and H. Clark. 2008. Reliability of the sulfur hexafluoride tracer technique for methane emission measurement from individual animals: An overview. *Aust. J. Exp. Agric.* 48(1-2):223-229.

Pinares-Patiño, C. S., C. W. Holmes, K. R. Lassey, and M. J. Ulyatt. 2008. Measurement of methane emission from sheep by the sulphur hexafluoride tracer technique and by the calorimetric chamber: Failure and success. *Animal* 2(1):141-148.

Pinares-Patiño, C. S., K. R. Lassey, R. J. Martin, G. Molano, M. Fernandez, S. MacLean, E. Sandoval, D. Luo, and H. Clark. 2011. Assessment of the sulphur hexafluoride (SF<sub>6</sub>) tracer technique using respiration chambers for estimation of methane emissions from sheep. *Anim. Feed Sci. Tech.* 166-167:201-209.

Pinares-Patiño, C. S., M. J. Ulyatt, G. C. Waghorn, K. R. Lassey, T. N. Barry, C. W. Holmes, and D. E. Johnson. 2003. Methane emission by alpaca and sheep fed on lucerne hay or grazed on pastures of perennial ryegrass/white clover or birdsfoot trefoil. *J. Agric. Sci.* 140(2):215-226.

Rigby, M., J. Mühle, B. Miller, R. Prinn, P. Krummel, L. Steele, P. Fraser, P. Salameh, C. Harth, and R. Weiss. 2010. History of atmospheric SF<sub>6</sub> from 1973 to 2008. *Atmospheric Chem. Physics* 10(21):10305-10320.

Swainson, N. M., I. M. Brookes, S. O. Hoskin, and H. Clark. 2011. Post-experiment correction for release rate in permeation tubes improves the accuracy of the sulphur hexafluoride (SF<sub>6</sub>) tracer technique in deer. *Anim. Feed Sci. Tech.* 166-167:192-197.

Wanninkhof, R., J. R. Ledwell, and W. S. Broecker. 1985. Gas exchange-wind speed relation measured with sulfur hexafluoride on a lake. *Science* 227(4691):1224-1226.

Zimmerman, P. R., inventor. 1993. System for Measuring Metabolic Gas Emissions from Animals. USA Pat. No. 5265618.

## 3 PRE-EXPERIMENTAL PLANNING – HOW MANY ANIMALS ARE NEEDED?

J.P. Koolaard<sup>a\*</sup>, D. Luo<sup>a</sup> & C. Grainger

<sup>a</sup>AgResearch Limited, Palmerston North, New Zealand

\*Corresponding Author: J. Koolaard, Email: [John.Koolaard@agresearch.co.nz](mailto:John.Koolaard@agresearch.co.nz)

---

### 3.1 Pre-experimental planning

When designing experiments that use the SF<sub>6</sub> technique to measure methane (CH<sub>4</sub>) emissions, it is important to include sufficient power to detect the expected differences in CH<sub>4</sub> yield between treatments. In his thesis, *Quantifying variation in estimated methane emission from ruminants using the SF<sub>6</sub> tracer technique*, Vlaming (2008) reported on experiments using the SF<sub>6</sub> technique which assessed the observed variance in CH<sub>4</sub> measurements of animals measured in chambers.

The coefficient of variation (CV) in CH<sub>4</sub> yields from calorimetry measurements reported was between 1% and 6% for within-animal, and 6% for between-animal variance. These values are less than half the reported within- (CV = 8-18%) and between-animal (CV = 11-16%) variance in estimates of CH<sub>4</sub> yield for housed stall-fed animals when using the SF<sub>6</sub> technique. For the SF<sub>6</sub> technique, one CH<sub>4</sub> measurement per day is usually obtained, thus the within-animal variation is the variance among such daily measurements, usually taken over several consecutive days, for the same animal. Note that in this chapter we deal with CH<sub>4</sub> yield - grams of CH<sub>4</sub> per kilogram of dry matter intake – and not CH<sub>4</sub> production in grams per day.

Estimates of repeatability and within- and between-animal variance in daily CH<sub>4</sub> yield were obtained (Vlaming, 2008), and used to develop a power analysis using a simulation study. This estimated the number of animals – and number of daily measurements per animal – required to detect a significant difference (P < 0.05) between two treatment groups. Since this required repeated measurements of CH<sub>4</sub> yield from the same animal, the simulations were performed (Chapter 20.5 in Gątecki and Burzykowski (2013)) using a mixed-effects model with variance-covariance matrix assumed to have an autoregressive (order 1) structure. The correlation parameter was 0.4, and between-animal and within-animal-between-days standard deviations were 4 (g/kgDMI), based on data from previous studies (Vlaming, 2008).

The simulation model was designed with two treatments: a high CH<sub>4</sub>-emitting group and a low CH<sub>4</sub>-emitting group. Three scenarios were considered, with differing degrees of separation – differences of 1.5, 1.0 and 0.5 standard deviations (SD) – between group means. The study simulated varying numbers of animals per treatment, and varying numbers of (daily) measurements per animal, then calculated the power for each combination. Power was defined as the number of occasions in 1000 simulations



(expressed as a percentage) that a significant difference was detected between the two groups (see Table 3.1).

The power analyses show the expected result: that when the difference between the means of two treatment groups of animals is small, more animals are required to detect a significant treatment difference (Table 1). Increasing the number of daily measurements per animal tends to increase the power of the experiment modestly, but only up to around five to seven measurements per animal (i.e., five to seven days). After this, little power is gained from further daily measurements on individual animals.

It is also desirable to optimise experiments to minimise the number of measurements (number of animals and measurements per animal) needed to detect a statistical difference. For example, using the standard 80% power requirement and 1.5 SD separation between the means of two groups, 10 animals would need to be measured seven times (70 samples) or 12 animals measured three times (36 samples).



**Table 3.1: Likelihood (%), of detecting a significant difference (at P < 0.05) between the means of two groups of animals – either 1.5, 1 or 0.5 within animal standard deviations (SD) apart – with a set number of animals per group, and a set number of consecutive measurements. This is for CH<sub>4</sub> yield estimated using the SF<sub>6</sub> technique.**

Animals per group	Number of daily measurements per animal									
	2	3	4	5	6	7	8	9	10	
<b>1.5 SD</b>										
7	50	52	54	61	59	61	65	64	63	
8	57	61	66	68	68	70	71	72	71	
10	68	72	76	77	77	82	84	85	84	
12	78	83	85	87	87	89	87	89	89	
<b>1.0 SD</b>										
14	50	50	59	58	64	59	63	62	62	
16	56	59	60	62	64	68	70	68	72	
20	67	72	72	77	75	79	80	81	80	
25	77	80	83	82	85	88	87	87	88	
<b>0.5 SD</b>										
70	64	64	69	70	71	74	74	76	76	
80	64	72	74	77	78	80	81	81	84	
90	72	79	77	80	82	85	88	85	87	
100	77	81	82	86	88	88	89	91	89	

A simpler, more approximate, approach avoids the need for repeated measurements analysis. By using just the average of the daily CH<sub>4</sub> measurements from each animal, it uses the expected difference between two group means and the animal-to-animal variation to calculate the total number of experimental animals required. Sample-size calculations were carried out, based on a simple two-sample t-test comparison of means. The power analysis calculates the number of animals required to achieve a power of 80% – the accepted standard for power analyses – at a 5% significance level. Calculations used a range of differences between means set in percentage terms, based on a population mean daily CH<sub>4</sub> yield of 20 g CH<sub>4</sub>/kg DMI, and a range of commonly reported coefficients of variation (CVs) for the SF<sub>6</sub> technique. Results are shown in Table 3.2.

**Table 3.2: Total number of experimental animals required to detect a significant difference in mean estimated CH<sub>4</sub> yield (g CH<sub>4</sub>/kg DMI) between two groups of animals with a specified coefficient of variation (CV) and expected difference between treatment means when using the SF<sub>6</sub> tracer technique.**

		Expected difference between treatment means				
		5%	10%	15%	20%	25%
CV (%)	10%	64	17	8	5	4
	15%	143	37	17	10	7
	20%	253	64	29	17	12
	25%	394	100	45	26	17

For example, if a 10% difference is expected between the means and using a range in CV from 15 to 20%, between 37 and 64 animals per treatment would be required to enable detection of the difference between treatment means when using the SF<sub>6</sub> technique.

### 3.2 Analysis of SF<sub>6</sub> data

Before statistical analysis, the data must be examined and assessed from a quality control perspective, including identification of data points which may be in error or are outliers in the set. It is worth reiterating that any decision to remove data points from a data set must be justified on technical (e.g. something went wrong with the equipment) or biological grounds, and not on statistical grounds alone. The integrity of the data must never be compromised in the name of data quality control. This matter is dealt with in Chapter 11.

Many papers describe statistical methods that may be used to analyse SF<sub>6</sub> data (Grainger et al., 2007, Grainger et al., 2010, Mc Geough et al., 2010, Pinares-Patiño et al., 2003). Approaches to data analysis differ, however, in the way researchers treat repeated measurements in time. Normally an SF<sub>6</sub> measurement period involves measuring a number of animals over a number of consecutive days, varying from three to five days. One approach with such data is to average the consecutive daily data over the measurement period and to present, for statistical analysis, one averaged data point for each animal for the period.

The other approach is to present all the daily data for each animal, and use a recognised model to analyse repeated measurements data, such as a mixed-effects statistical model technology, which is the current standard for analysis of this kind of data, and implemented in the most widely-used statistical software. The second approach is preferable, as it allows for within-animal between-day variation to be estimated, revealing more information from the experimental data.

### 3.3 References

Gałecki, A. and T. Burzykowski. 2013. Extensions of the R Tools for Linear Mixed-Effects Models. Pages 491-523 in *Linear Mixed-Effects Models Using R*. Springer New York.

Grainger, C., T. Clarke, S. M. McGinn, M. J. Auldist, K. A. Beauchemin, M. C. Hannah, G. C. Waghorn, H. Clark, and R. J. Eckard. 2007. Methane emissions from dairy cows measured using the sulfur hexafluoride (SF<sub>6</sub>) tracer and chamber techniques. *J. Dairy Sci.* 90(6):2755-2766.

Grainger, C., R. Williams, R. J. Eckard, and M. C. Hannah. 2010. A high dose of monensin does not reduce methane emissions of dairy cows offered pasture supplemented with grain. *J. Dairy Sci.* 93(11):5300-5308.

Mc Geough, E. J., P. O'Kiely, P. A. Foley, K. J. Hart, T. M. Boland, and D. A. Kenny. 2010. Methane emissions, feed intake, and performance of finishing beef cattle offered maize silages harvested at 4 different stages of maturity. *J. Anim. Sci.* 88(4):1479-1491.

Pinares-Patiño, C. S., M. J. Ulyatt, K. R. Lassey, T. N. Barry, and C. W. Holmes. 2003. Persistence of differences between sheep in methane emission under generous grazing conditions. *J. Agric. Sci.* 140(2):227-233.

Vlaming, J. B. 2008. Quantifying variation in estimated methane emission from ruminants using the SF<sub>6</sub> tracer technique. in *Animal Science*. Vol. PhD Thesis. Massey University, New Zealand.

## 4 PERMEATION TUBES: THE SOURCE OF SF<sub>6</sub>

K.R. Lassey<sup>a\*</sup>, P.J. Moate<sup>b</sup>, S.R.O. Williams<sup>b</sup>, M.H. Deighton<sup>b</sup>, C. Martin<sup>cd</sup>, R.S. Hegarty<sup>e</sup>, A. Berndt<sup>f</sup> & A.D. Iwaasa<sup>g</sup>

<sup>a</sup>Lassey Research & Education Ltd, Lower Hutt, New Zealand

<sup>b</sup>Department of Environment and Primary Industries (DEPI), Ellinbank, Victoria, Australia

<sup>c</sup>INRA, UMR1213 Herbivores, Saint-Genès-Champagnelle, France;

<sup>d</sup>Clermont Université, VetAgro Sup, UMR1213 Herbivores, Clermont-Ferrand, France

<sup>e</sup>School of Environmental and Rural Science, University of New England, Armidale NSW, Australia

<sup>f</sup>Embrapa, Fazenda Canchim, São Carlos, SP - Brasil

<sup>g</sup>Agriculture and Agri-Food Canada/Agriculture et Agroalimentaire Canada - Semiarid Prairie Agricultural Research Centre, Saskatchewan, Canada

\*Corresponding Author: K.R. Lassey, Email: [keith.lassey@lasseyresearch.co.nz](mailto:keith.lassey@lasseyresearch.co.nz)

---

This chapter looks at the designs of permeation tubes used by various research groups, the determination of SF<sub>6</sub> release rate from individual tubes ('tube calibration'), and investigations of tube performance.

### 4.1 Tube design and properties

The source of SF<sub>6</sub> is a permeation tube inserted into the rumen of each animal prior to the start of the experiment. Each tube releases its charge of SF<sub>6</sub> through a permeable 'window' at a rate governed by the window size, membrane thickness, and temperature. The rate of SF<sub>6</sub> release is determined through a calibration process prior to the experiment, usually serial weighing over several weeks at a controlled temperature of 39°C.

The original tube design by Johnson et al. (1994), shown in exploded detail by Johnson et al. (2007), has undergone several variations. The Johnson et al. (1994) design was based on  $\frac{7}{16}$ " (11.1 mm) stainless steel or brass rod, 32 mm in length, drilled with a blind hole, and threaded to match a  $\frac{1}{4}$ " Swagelok nut (brass part number B-402-1, fitted by a  $\frac{9}{16}$ " spanner). With a circular PTFE (polytetrafluoroethylene, commonly

termed 'Teflon') membrane approximately 0.27 mm thick, SF<sub>6</sub> permeation rates at 39 °C of 1000–2000 ng/min (1.4–2.9 mg/d) were achieved. A porous stainless steel frit (2 µm pores) mechanically supported the Teflon membrane against internal pressure. The ¼" (6.35 mm) diameter hole in the Swagelok nut provides a 'window' through which SF<sub>6</sub> permeating the membrane is released.

Lassey et al. (1997) adopted the Johnson et al. (1994) design, modified only by the introduction of flat faces on a lengthened brass tube so it could be tightened by a spanner. The tubes were originally intended for use with either cattle or sheep, according to the SF<sub>6</sub> permeation rate. Even when the nut on a permeation tube is tightened to a standard torque of ~10 N-m, and re-tightened to that torque after room temperature is attained after cryogenic filling, SF<sub>6</sub> permeation rates varied by more than a factor of two. Upon dismantling, the Teflon membranes were always found to be appreciably distorted and creased, which Lassey et al. (2001) reasoned may be partly a consequence of the outer perimeter of the Teflon being gripped and crushed between tube and nut, distorting the window portion that makes contact with SF<sub>6</sub>. That distortion would in turn increase the surface area of Teflon in contact with SF<sub>6</sub>, and potentially introduce creases at weak points or otherwise stretch the Teflon, which might partially account for the variability in permeation rate.

As a solution, Lassey et al. (2001) introduced a nylon washer, reasoning that if it absorbed some of the crush from the applied torque, it would lessen the Teflon distortion. Such a washer could also counter tube failures caused by minute scratches in the tube face acting as a conduit for SF<sub>6</sub> escape. Use of the nylon washer appeared to have three consequences: first, the variability in SF<sub>6</sub> permeation rates was reduced, though not markedly; second, the SF<sub>6</sub> permeation rate was appreciably lower – typically 0.7–1.8 mg/d – and third, an almost zero level of failure to retain SF<sub>6</sub> has since been experienced. The lowered permeation rate was attributed to the effective window size being reduced to the internal diameter of the partially-crushed nylon washer. As a result, the permeation rates proved to be too low for ideal use with cattle. This was temporarily fixed by deploying two tubes per cow while a larger tube was designed and commissioned. The dual-tube solution was not ideal because it meant two tubes per animal had to be calibrated, rather than one, and because uncertainties were compounded.

The larger 'cattle tubes' designed by Lassey et al. (2001) are based on 9/16" (14.3 mm) brass rod, 38 mm long, threaded to match a 3/8" brass Swagelok nut (part number B-602-1, fitted by a 11/16" spanner), which has a 3/8" (9.53 mm) diameter window. Typical SF<sub>6</sub> loads were three to four times those of the smaller tubes – now renamed 'sheep tubes' – with permeation rates between 2.5 and 6.5 mg/d. The first cattle tubes were fabricated in April 2000. The cattle and sheep tubes developed by Lassey et al. (2001) – hereafter referred to as NIWA tubes – have been supplied to many international research groups since September 2003.

Although the tubes designed by Johnson et al. (1994, 2007) are intended for use with cattle, they are the same size as the NIWA sheep tubes.

Figure 4.1 shows an exploded view of the NIWA tubes, taken from Lassey et al. (2001), and Table 4.1 reports representative properties. A Teflon membrane 0.27mm thick is the normal choice for both sheep and cattle tubes, though both thinner and thicker membranes have been trialled to achieve faster and slower permeation rates.

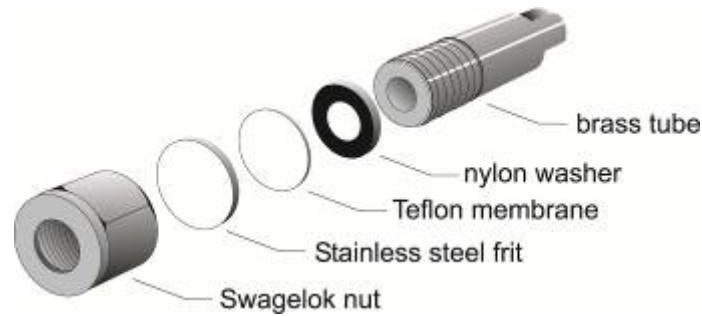

Figure 4.1: An exploded view of NIWA permeation tubes (Lassey et al., 2001) of which there are two sizes; sheep tubes and cattle tubes (Table 4.1).

---

*The design was based on that of Johnson et al. (1994, 2007), but with the inclusion of a nylon washer and flat faces at the closed end to enable gripping or holding while applying torque. The Johnson et al. design had just one size equivalent to the NIWA sheep tubes.*

**Table 4.1: Representative properties of NIWA permeation tubes.**

Property	Sheep tubes	Cattle tubes
External diameter, excluding nut	11.1 mm	14.3 mm
Swagelok nut, spanner size	12.7 mm	15.9 mm
Internal bore diameter	4.8 mm	7.9 mm
Bore depth at centre	27 mm	38 mm
Internal volume available for SF <sub>6</sub>	0.45 ml	1.7 ml
Tare mass, including washer, membrane, frit, nut (typical)	32 g	57 g
SF <sub>6</sub> charge (typical)	800 mg	2400 mg
'Minimum useful' SF <sub>6</sub> load <sup>1</sup>	150 mg	600 mg
Range of SF <sub>6</sub> permeation rates at 39°C (typical) <sup>2</sup>	0.7–1.8 mg/d	2.5–6.5 mg/d

<sup>1</sup> 'Minimum useful load' (MUL) refers to the SF<sub>6</sub> load that remains in gaseous phase when all non-gaseous SF<sub>6</sub> is exhausted. Thereafter, permeation rates fall in response to falling internal pressure (Lassey et al., 2001), and the loaded permeation tube is no longer useful. The MUL itself is proportional to internal volume at 344 mg(SF<sub>6</sub>) per ml at 39°C.

<sup>2</sup> Within a particular batch of tubes, the range of permeation rates will normally be narrower: the cited ranges are those normally considered to be acceptable and of assured quality.

At INRA, France, Martin and co-workers adopted the Johnson et al. tube design, but based on a 12.5 mm diameter brass rod, 40 mm long and threaded to accept a ¼" Swagelok nut. Typical SF<sub>6</sub> loads were 600–700 mg. INRA tubes have been used by various European research groups in sheep and cattle trials over the past decade.

Iwaasa and co-workers at Agriculture and Agri-Food Canada (AAFC) have designed cattle tubes, very similar to NIWA's, for use in dairy and beef cattle trials. The AAFC tubes have been supplied to numerous research groups in Scandinavia and the United States over the past seven years.

At Embrapa, Brazil, Berndt and co-workers developed 'long-term' permeation tubes, mainly to achieve the targets of the Pecus Project, which aims to evaluate methane (CH<sub>4</sub>) emissions from the same animals over several months: beef cattle from weaning to slaughter (18 months) and dairy cows during the lactation period (nine months). These long-term permeation tubes are brass-bodied, with an external diameter of 7/16" (11.1 mm), and a length of 32 mm. They are drilled with a blind 6 mm hole to a depth of 30 mm, and threaded to match a ¼" Swagelok nut. With a Teflon membrane

approximately 0.40 mm thick, suitable SF<sub>6</sub> permeation rates at 39°C of between 600 and 1300 ng/min (0.9–1.9 mg/d) were achieved. A porous stainless steel frit with 2 µm pores supports the Teflon membrane, and a 0.7mm-thick nylon washer reduces Teflon deformation.

Because emission rates are relatively low, two permeation tubes are needed per animal, with long operational lifetimes. Although 'double dosing' requires that twice as many tubes be prepared and calibrated, an advantage is that tubes can be paired so as to achieve a desirable and consistent combined release rate, reducing the range between repetitions.

Hegarty et al. (2003) at Armidale in NSW, Australia developed permeation tubes with much higher SF<sub>6</sub> release rates of 170 to 275 mg/d, so as to utilise infrared spectroscopy (IRS) to detect SF<sub>6</sub> and to explore alternative tracers to SF<sub>6</sub>. However, none of those alternatives with IRS detection had all the desirable attributes of SF<sub>6</sub>, such as low ambient concentration, moderate head-space pressure in permeation tubes, and high molecular weight. Moreover, with much higher SF<sub>6</sub> detection limits by IRS than by GC, the higher release rates were needed (Machmüller and Hegarty, 2006).

Furthermore, a higher permeation rate of SF<sub>6</sub> might have allowed analysis of breath samples by benchtop FTIR (Fourier Transform Infrared Spectroscopy), but this could not be achieved by Armidale researchers with the path length of available cells. A further hypothesis was that tubes with a high release rate would also have a short (one month) life span, thus enabling independent repeated measurements to be made on animals by inserting new permeation tubes over a year. These 'high-flow' permeation tubes were milled from series 2000 aluminium rod, with thread cut at both ends (28.4 mm x 1.02 threads per mm) and drilled with a U-channel, providing a total chamber volume of 4.2 ml (Figure 4.2). Castellated brass caps at both ends were rebated to support a 25mm stainless steel frit, overlying a Teflon membrane (28 mm dia; 250 µm or 125 µm) and flexible clear PVC washer (28 mm external diameter, 20 mm internal diameter).



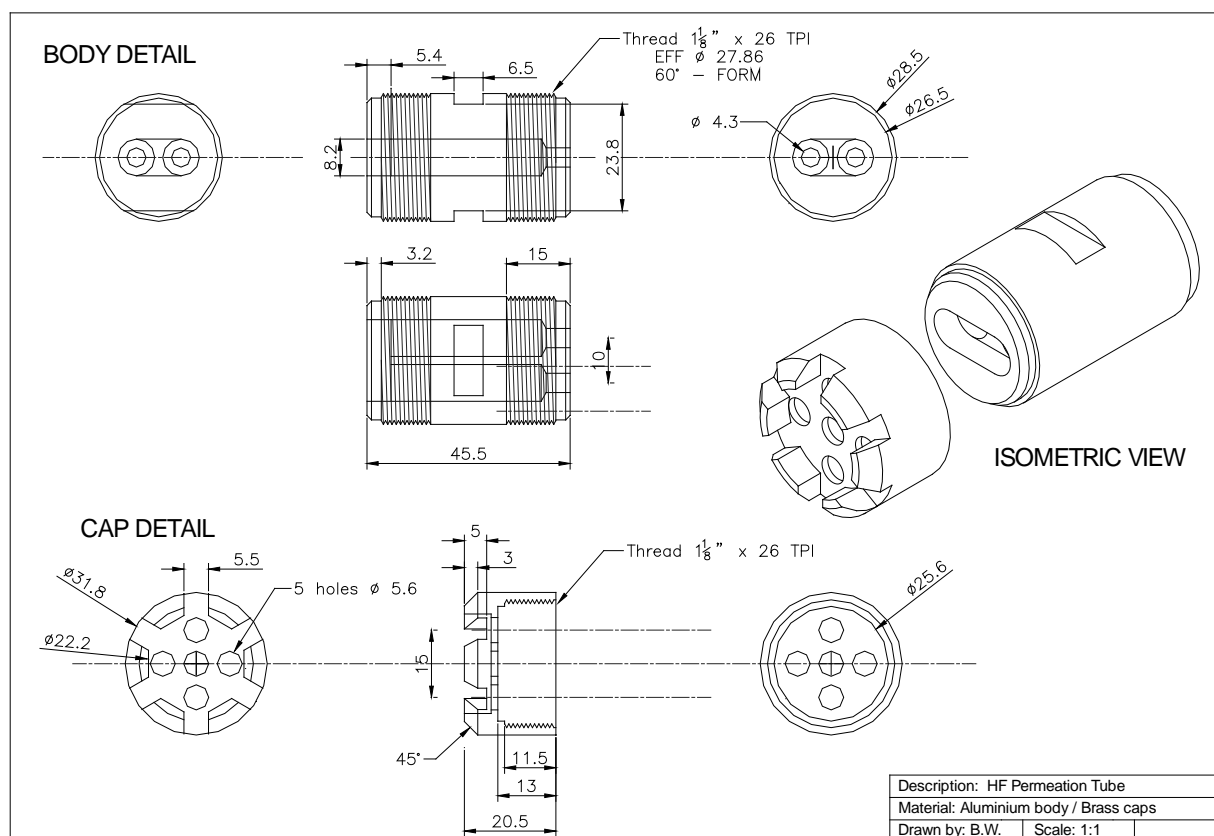

Figure 4.2: Engineering diagram for a high flow permeation tube used to deliver SF<sub>6</sub> or other tracer gases (Hegarty et al., 2003).

*With brass end-caps and aluminium body these tubes were adequate for releasing SF<sub>6</sub>, but end-cap threads could shear if used for gases at higher vapour pressure such ethane or methane isotopologues, necessitating that endcaps be made of stronger material such as stainless steel.*

## 4.2 Tube filling

Filling tubes with SF<sub>6</sub> is conceptually simple, and within the resources of many physics or chemistry laboratories. However, care is essential to assure quality control.

Johnson et al. (2007) described their method of charging the tubes with SF<sub>6</sub>, summarised as follows: components are assembled and tare weighed, then dismantled. Each tube body is immersed in liquid nitrogen until fully chilled to -196°C, then drained. Using a 120 ml plastic syringe, pure SF<sub>6</sub> is then quickly transferred into the upright tube, where it freezes on contact. The tube is immediately capped by the nut with enclosed frit and Teflon membrane to achieve a load of ~600 mg SF<sub>6</sub>.

Lassey and co-workers at NIWA adopted a standard filling procedure using a polycarbonate glove box (Figure 4.3) as follows. The glove box is swept with air pumped through a molecular-sieve trap to reduce moisture and CO<sub>2</sub>, a precaution that

minimises condensation on the chilled tube surfaces. Tubes are filled in groups of six (sheep tubes) or four (cattle tubes) in a purpose-designed brass block with six or four wells surrounded by a channel to be filled with a 'moat' of liquid nitrogen as coolant (Figure 4.3).

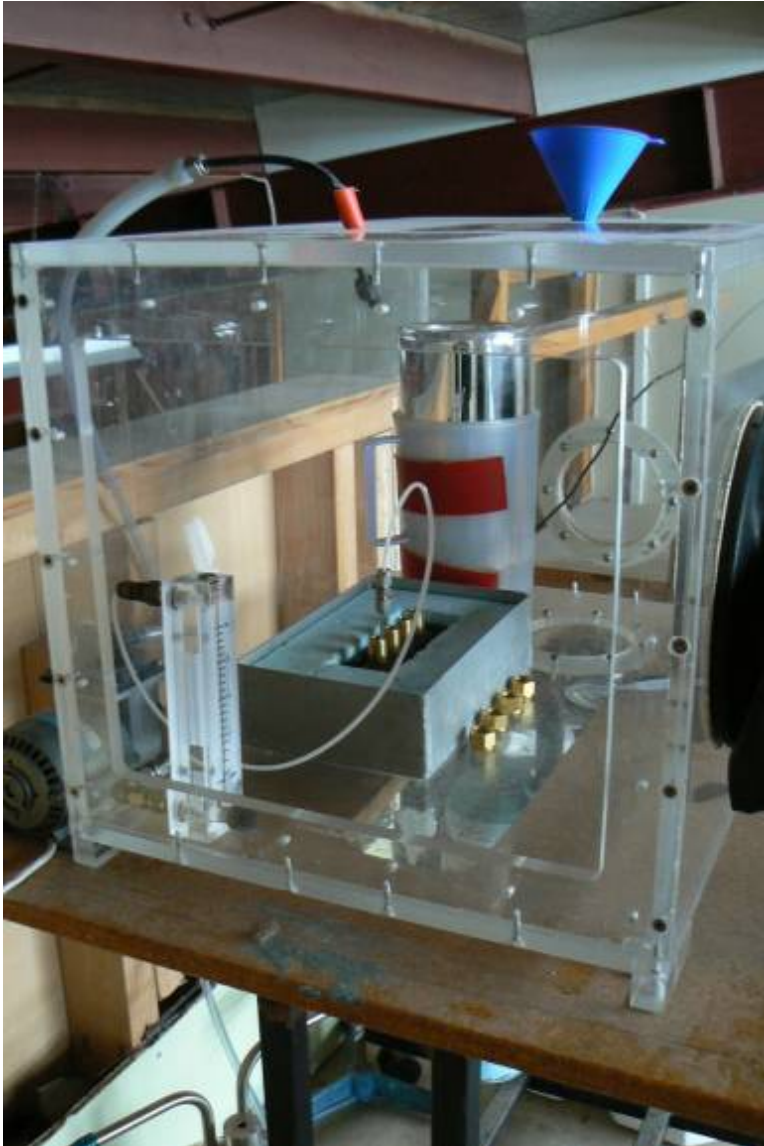

Figure 4.3: The NIWA facility for charging permeation tubes with SF<sub>6</sub>.

*The polycarbonate glove box (internal dimensions H×W×D: 38.5×61×40 cm; wall thickness 1.2 cm) encloses, from left: a flow meter to monitor the flow rate of SF<sub>6</sub> during filling; a brass block drilled to house four cattle tubes (another block houses six sheep tubes) and grip the closed-end faces of those tubes, enclosed in a polystyrene insulator; vacuum flask with liquid nitrogen; four nuts with enclosed washer, membrane and frit associated with (and tared with) the four tubes.*

*The sweep gas, through the red inlet in the glove box ceiling, is air pumped through a molecular sieve filter to remove moisture and traces gases such as CO<sub>2</sub>. The blue funnel on the glove box ceiling admits liquid nitrogen to top up the flask from a dewer. A channel near the perimeter of the brass block is kept filled with liquid nitrogen to maintain it at -196 °C. The nylon tubing (3.18 mm o.d.) shown delivers SF<sub>6</sub> to each tube through a stainless steel dispenser (1.59 mm o.d.) at a continuous flow rate determined by regulator pressure, for a prescribed time. A torque wrench is used to cap the tubes to 10 N-m immediately after filling. Up to ~100 unfilled tubes and filled tubes can be retained separately inside the glove box.*

A pair of jaws at the base of each well grasps the tube, enabling a torque to be applied *in situ* without turning the tube. The brass block is enclosed on all sides and beneath by an insulating polystyrene block. A small vacuum flask inside the glove box contains a supply of liquid nitrogen which is replenished by funnelling through a small hole in the glove box ceiling. Current procedure adopts 'continuous filling', which uses a regulated SF<sub>6</sub> flow direct from a cylinder for a specified time: 88 ml(SF<sub>6</sub>)/min for 40 s, or 220 ml(SF<sub>6</sub>)/min for 60 s, for sheep and cattle tubes respectively. The SF<sub>6</sub> charges achieved are reported in Table 4.1. Batches of ~100 tubes have been charged without having to open up the glove box.

Prior to adopting a glove box, NIWA researchers encountered problems when filling tubes in a fan-driven fume cupboard. These problems arose from moisture trapped in the tubes, presumably sourced from the air flow drawn by the fan. In contrast, the initial practice of filling tubes on a benchtop did not strike this condensation problem, probably because a persistent blanket of evaporating nitrogen was largely impervious to uncondensed moisture. Since about 1999, the glove box approach has been used exclusively to fill more than 3000 tubes, as it provides better control of the filling environment.

The procedure at INRA, France, is to tighten the tube to achieve a permeation rate in the range of 1–2 mg(SF<sub>6</sub>)/d, rather than to a standardised torque. Tubes with the lowest permeation rates are used with sheep, the higher ones with cattle. Fills of between 600 and 900 mg SF<sub>6</sub> were achieved. However, around a quarter of tube fills failed to perform adequately, and such failures have to be taken into account when planning the number of tubes to be filled.

At AAFC, Canada the filling procedure is very similar to Johnson et al., achieving a fill of between 2400 and 2600 mg of SF<sub>6</sub> in their larger tubes (Iwaasa et al., 2004).

At Embrapa, Brazil, the 'long term' tubes are filled in groups of five in an aluminium block with five holes, immersed in liquid nitrogen, using a variant of the NIWA continuous filling process reported above but without the glove box. The room must be refrigerated so as to reduce liquid nitrogen evaporation, especially during the summer. The nuts are tightened to a standardised torque of ~7.5 N-m, but are not re-tightened to that torque once warmed to room temperature, as it seems this may contribute to Teflon deformation. The SF<sub>6</sub> load achieved with this design is 1300±150 mg, of which the 'minimum useful load' (refer Table 4.1) is 250 mg and the estimated useful lifetime is 800 days. Approximately 1% of the filled tubes might have to be

discarded as a result of poor performance due to leaks or damage. With the need for standardised emission rates which would be expected to be distributed normally, the number of tubes filled usually exceeds the number required for the experiment by 30%.

At Armidale, Australia, where high flow permeation tubes are used, the lower end-cap (housing, frit, membrane and washer) is fitted and tightened before the tube is lowered into an insulated box (18 × 18 × 20 cm internal dimensions) containing liquid nitrogen deep enough to cover approximately two-thirds of the height of the tube. Tubes are filled using eight 120 ml syringes prefilled with SF<sub>6</sub>, with the three-way tap of each syringe fitted to a 13 gauge needle used to introduce the SF<sub>6</sub> into the permeation tube.

On completion the top end-cap with frit, membrane and washer already fitted is hand-tightened onto the body, and the tube removed to the lab bench, where the upper end-cap is tightened quickly using a spanner custom-made to fit the castellated end-cap. The filled and sealed tube is then held under running water (which initially freezes over the tube) for approximately one minute before the end-caps are retightened. Then the tube is submerged in a shallow water bath, held at 38°C, where any leaks become apparent as bubbles. End-caps on any leaking tubes are further tightened, and those that persistently leak are discarded. Tubes are dried with paper towels, and an approximate weight determines SF<sub>6</sub> retention before they are placed in an oven at 39°C to dry. Weighing begins 48 hours later.

### 4.3 Tube calibration

Tube calibration determines individual SF<sub>6</sub> release rates to high accuracy (three to four significant figures). This is usually done gravimetrically by the serial weighing of tubes kept at 39°C – the nominal mean rumen temperature in cattle and sheep. Researchers working with grazing dairy cows have found that, after several weeks, orally-administered tubes are usually found in the reticulum.

Calibrating through direct measurement of the released SF<sub>6</sub> avoids the assumption that mass loss is due entirely to SF<sub>6</sub> loss. However, collection of the permeating gases and analysis by gas chromatography generally lacks the precision that could challenge gravimetric calibration. Nevertheless, there is a risk that some condensable gases – notably water vapour and CO<sub>2</sub> – may have become entrapped with SF<sub>6</sub> during the filling procedure, subsequently permeate out and contribute to mass loss.

Lassey et al. (2001) reported that the rate of mass loss after tube fill initially declined, before stabilising after a 'settling period' of about 14 days (occasionally longer, depending on the circumstances of the fill. See Section 4.4). They surmised that this was likely due to permeation of trapped moisture, a conjecture confirmed by the presence of liquid water in opened tubes. Filling tubes in a glove box, swept with air passed through a moisture trap, was specifically designed to minimise trapped moisture. Accordingly, Lassey et al. (2001) recommended discarding any weight data during this settling period, effectively delaying the start of calibration.

The following quality control procedures should be taken into account during tube calibration:

### ***Weighing tubes***

The permeation tubes must be weighed precisely to secure accurate estimates of tracer permeation rates, and this requires practice and experience. Techniques for accurately weighing items using laboratory balances are described in a number of laboratory-focussed text books (e.g., Christian, 1997). An electronic balance, capable of weighing to 0.1 mg or better, is needed. Such balances are fitted with a weigh-pan enclosure to prevent interference from air currents (see Figure 4.4). The balance should be placed on a sturdy surface, such as a concrete bench securely connected to a concrete floor in a dedicated weigh room, to minimise vibrations.



**Figure 4.4:** A Sartorius CP224S electronic balance as used to weigh permeation tubes at Department of Environment and Primary Industries, Ellinbank, Victoria, Australia.

---

*Note the use of cotton gloves to prevent perspiration from influencing measured permeation tube weight.*

The balance should be prepared, turned on and allowed to warm up prior to any weighing, as outlined in its user manual. The balance is then 'zeroed' with the enclosure doors shut. Permeation tubes should be handled with cotton gloves or powder-free disposable gloves to stop moisture or perspiration causing inaccurate weights. Each tube is placed gently in the centre of the balance pan, and the balance door is closed. Once the balance digital display has stabilised, the weight can be recorded and the permeation tube then removed. A certified calibration weight or



dedicated laboratory standard weight (similar in weight to the permeation tubes) should also be weighed as a check on any drift in balance performance.

To avoid repeated disturbance of the incubator, tubes can be weighed in batches, taking up to an hour. Local standard time should be recorded at the beginning and end of weighing each batch, and the midpoint time associated with the weighing of each tube in the batch. Thus, the tubes might be out of the 39°C environment for up to an hour, and each tube's calibration time accurate to within 30 minutes: neither is of any consequence. If the same batches are retained for all weighings, the same regression formulae – weight against time – can be used across the batch.

### ***Incubation of permeation tubes***

Gravimetric calibration techniques differ, but all require that tubes be 'incubated' in a dry environment at constant temperature, and that permeation tubes be individually weighed every three to seven days. Individual permeation rates can then be deduced through linear regression fits of mass versus elapsed time (Lassey et al., 2001). Lassey et al. routinely obtain a linear regression fit over eight weeks (following the settling period), with  $R^2$  exceeding 0.9995, and any tubes not meeting this criterion are not inserted into animals.

Johnson et al. (2007) recommend placing tubes in a glass receptacle immersed in a 39°C water bath, and weighing them weekly to the nearest tenth of a microgram for at least five or six weeks. Lassey et al. (2001) reported the properties of tubes held in a laboratory incubator at 39°C and weighed weekly to the nearest 0.1 mg.

Rochette et al. (2012) have recently suggested that it may be preferable to calibrate permeation tubes after exposure to ruminal liquor – or other aqueous environment – rather than in a dry environment, as proposed in the original method of Johnson et al. (2007) and commonly adopted. This surprising result – not yet independently confirmed – was not found by Lassey et al. (2001), and is also at variance with a finding by Deighton et al. (2013a) that submersion in water does not affect SF<sub>6</sub> permeation rates. However, it is important to recognise the potential for moisture to permeate into the tube – a process consistent with diffusion along a partial pressure gradient for water vapour – and that once the tube is transferred back to a dry environment, such intruded water will permeate out again over time.

With higher precision balances (e.g., accurate to  $\pm 1 \mu\text{g}$ ) and more frequent weighing (e.g., twice weekly), more precise estimates of permeation rate may be possible for tubes with very low permeation rate, which could shorten the calibration time. That calibration time (excluding the settling period, when calibration weights are unused) should nevertheless be comparable to, or exceed, the duration of the experiment, irrespective of weighing precision. This enhances confidence in extrapolating calibration performance throughout the experimental duration (see Section 4.4).

A good rule of thumb is that tubes be calibrated for a minimum of six weeks and up to half as long as the planned experimental duration with a practical maximum of 10 weeks. That implies confidence that any tubes calibrated over a period of  $T_{calib}$  will continue to perform as extrapolated for a further  $2 \times T_{calib}$ . For an experimental

duration exceeding about 20 weeks without recovery and recalibration of the tubes, consideration should be given to accounting for a changing permeation rate (Section 4.4).

More than 50 published scientific papers report the use of the SF<sub>6</sub> tracer technique in animal research, but few authors have described how their permeation tubes were incubated. Pavao-Zuckerman (1999), Martin et al. (2008, 2012) and Pinares-Patiño et al. (2007) reported incubation in a water bath, while Lassey et al. (2001) reported using an 'oven'; most other authors were non-specific. As best practice, we recommend that the ambient temperature is stable to within  $\pm 0.2^\circ$  of  $39^\circ\text{C}$ , and verifiable as such by a calibrated mercury thermometer placed with the tubes. The environment could be a dedicated laboratory incubator, or an oven from a decommissioned gas chromatograph.

At the Department of Environment and Primary Industries, Ellinbank, Victoria, Australia (DEPI Ellinbank) staff use a very accurate thermometer with NIST-traceable calibration (ICL Calibration Laboratories Inc. Stuart, Florida, USA) ( $-1.0$  to  $51.0^\circ\text{C}$ ,  $\pm 0.1^\circ\text{C}$ ) to verify a temperature-stable Heratherm IMH 60 incubator (Thermo Fisher Scientific, Melbourne, Australia). Previously, permeation tubes were incubated in a Contherm Digital Series 5 Incubator. In this type of incubator, a specific temperature can be set by digital control. However, it was a concern that discrepancies of up to two degrees were detected between the digital setting on the Contherm incubator and the true interior temperature as measured with a glass-mercury thermometer. By way of a fix, a mercury thermometer (temperature range  $35 - 42^\circ\text{C}$ ) was instead used to calibrate the incubator, and the set temperature adjusted until the thermometer in the incubator read  $39^\circ\text{C}$ . However, many standard glass-mercury thermometers may only be accurate to within  $\pm 0.5^\circ$  of  $39^\circ\text{C}$ .

At NIWA, New Zealand, a Contherm Laboratory Culture Incubator, model 1050 (Contherm Scientific Ltd, Petone, New Zealand) is used for tube calibration. This model, with an internal volume of 50 litres, has a digital set-point for temperature with a rated temporal variation of  $\pm 0.2^\circ\text{C}$ , and spatial variation of  $\pm 0.6^\circ\text{C}$  with a rated temperature stability of  $\pm 0.2^\circ\text{C}$ . Checks with a mercury thermometer have found no temperature-offset issues.

In Armidale, Australia (Hegarty et al., 2003), the high flow tubes are incubated in a Labmaster (Anax Pty Ltd) incubator at  $39^\circ\text{C}$ , with all tubes (typically 24, including empty control tubes) removed together and weighed. The exact minute of weighing is recorded, as tubes are weighed only on post-fill days 2–14, prior to insertion.

Charged tubes can be preserved at reduced permeation rate by chilling or freezing them, noting that permeation rates decline with temperature. When stored in a freezer at  $-80^\circ\text{C}$ , SF<sub>6</sub> permeation effectively stops, but fully recovers, with unchanged permeation rate, upon warming to  $39^\circ\text{C}$  (Deighton et al., 2011). NIWA and INRA have confirmed these findings. This means it can be cost-effective to store and freeze charged tubes in large batches once they have been checked for an acceptable permeation rate. They should be fully calibrated before use according to the above rule of thumb.

## 4.4 Tube performance

An implicit assumption of the SF<sub>6</sub> tracer technique is that permeation tubes inside the rumen release SF<sub>6</sub> at exactly the same rate as they do in the calibration environment. It is also assumed that SF<sub>6</sub> is emitted by the animal at the same rate, averaged over a few eructation cycles, as it is released from the tube, although in practice, it matters only that the average emission rate during a breath collection matches the release rate from the tube. Some detailed experiments have challenged these assumptions.

### Long-term changes to SF<sub>6</sub> permeation rate

Lassey et al. (2001) monitored the performance of representative NIWA-designed sheep tubes throughout a SF<sub>6</sub> release period of up to two years. Rather than a constant SF<sub>6</sub> permeation rate until the SF<sub>6</sub> charge was depleted, they were surprised to find that permeation rates slowly declined, so that a plot of tube mass versus time was curved, concave upwards, rather than linear (termed 'permeation curvature'). While they could not explain such curvature, Lassey et al. noted that the internal pressure, being the saturated SF<sub>6</sub> vapour pressure at 39°C, would be ~32 bar (3200 kPa) where SF<sub>6</sub> does not obey the ideal gas law ( $PV = nRT$ ), with the possibility of non-intuitive properties. The degree of non-linearity appears to vary among batches of tube fills, and potentially among individual tubes for reasons unknown, but presumably related to the conditions and circumstances of the fill. Figure 4.5 illustrates the Lassey et al. (2001) findings, illustrating also the pitfall associated with calibrating a tube too early after filling, and for too short a period (established with hindsight).

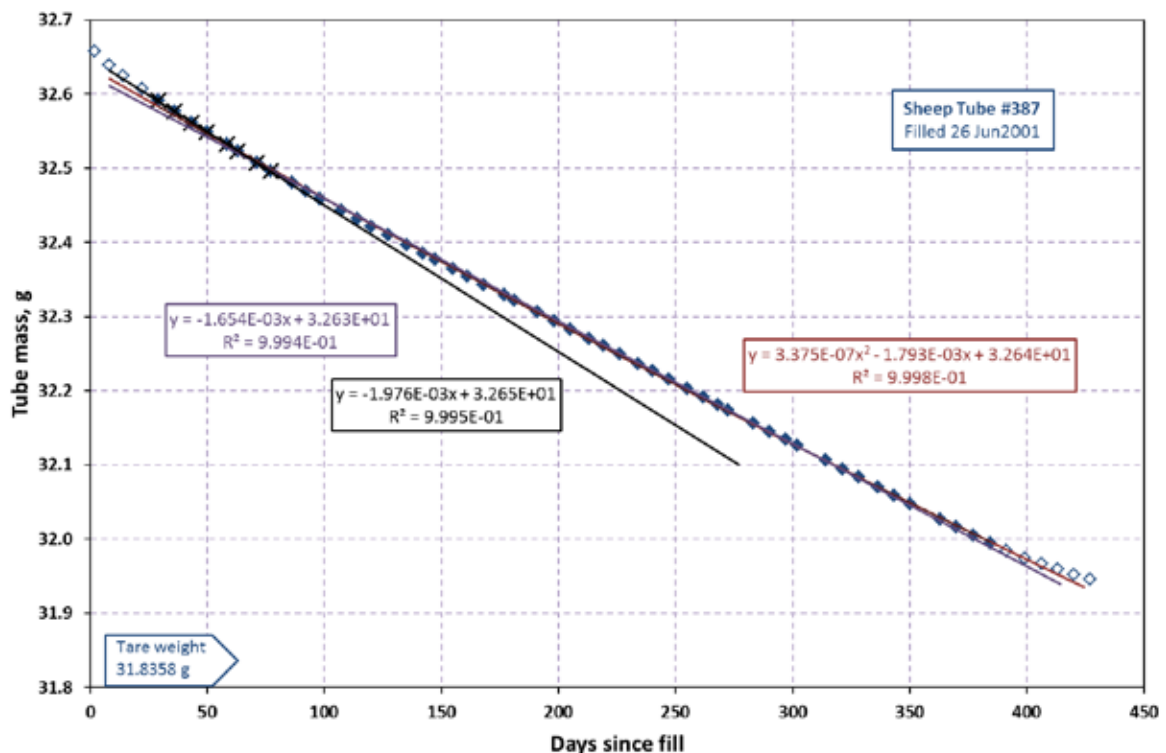

Figure 4.5: Sheep tube #387 filled at NIWA, New Zealand, on 26 Jun 2001 was one of six 'left-over' tubes retained for a longevity experiment from a batch of 40 tube fills.



*The six tubes were outside the target range of permeation rate for an experiment requiring 34 'insertion tubes'. Thus, they were not selected randomly from the 40, and therefore not strictly 'surveillance tubes' in the parlance of Lassey et al. (2001). The six tubes were retained for 427 days in the calibration environment (a Contherm incubator, model 1050, held at 39.0°C), removed only for the purposes of weighing. The blue diamonds show the tube mass, weighed approximately weekly, from two days after filling (Day 2) until Day 427. The solid diamonds show the weights from which two regression fits were determined (Days 29–384). After Day 384 (hollow diamonds) the mass of the SF<sub>6</sub> charge falls below its 'minimum useful load' of 150 mg. Prior to Day 29, the tube was deemed not to have 'settled' (moisture permeation presumed to contribute significantly to mass loss) as adjudged by  $R^2 < 0.9995$  for a fit to Day 384. The equations for the two regression fits to the solid diamonds, linear (purple line) and quadratic (dark red line), are shown in text boxes with borders and text of matching colour. Also shown is a linear regression fit to 8 data points shown with black overcrosses for Days 29–77 (black line with equation in black-bordered box). Day 77 was the last calibration date for the 34 'insertion tubes' that were siblings of Tube #387. Thus, the regression fit of Days 29–77 would be the only fit available had Tube #387 been selected as an insertion tube.*

*This particular tube fill is selected more as an illustration of the need for care when calibrating rather than as typical. It is clear that the best estimate of SF<sub>6</sub> permeation rate, Days 29–384, is 1.654 mg/d, whereas the quadratic simulation, imperfect prior to about Day 50 (perhaps, with hindsight, moisture was still permeating significantly?) suggests a permeation rate steadily falling from 1.773 mg/d at Day 29 through 1.741 mg/d at Day 77 to 1.534 mg/d at Day 384 (calculated using Eqn (4.2) with the quadratic fit). Yet the regression fit for Days 29–77 (the black line) suggests a higher mean permeation rate at 1.976 mg/d over those 48 days. Thus, with hindsight, some or even all of the 34 insertion tubes may have had their permeation rates overestimated if their settling periods were as long as that for Tube #387, resulting in only seven weeks (eight data points) of effective calibration. Thus tubes should be filled at least 12 weeks prior to a planned insertion date, in order to allow an ample settling period followed by at least six weeks (preferably eight to 10 weeks) of calibration.*

As an empirical model for permeation curvature, Lassey et al. (2001) applied the following quadratic regression equation to express the mass of the charged tube  $W(t)$  as a function of elapsed time  $t$  since charging with SF<sub>6</sub> (or since placement in 39°C environment after retrieval from a freezer).

$$W(t) = W_0 - at + bt^2$$

Eqn 4. 1

*The initial SF<sub>6</sub> charge is given by  $W_0$  less the tared components shown in Figure 4.1. Eqn 4.1 applies only until the charge is depleted to the point when only gaseous SF<sub>6</sub> remains.*

During the period with non-gaseous phase present, the SF<sub>6</sub> internal pressure remains steady at its saturated vapour pressure for 39°C (viz, 32 bar), but once non-gaseous SF<sub>6</sub> is exhausted as a result of replenishing permeation losses from the gaseous phase, internal pressure – and accordingly, the SF<sub>6</sub> permeation rate – steadily declines. The residual SF<sub>6</sub> load at the point of exhaustion of non-gaseous phase was termed the ‘minimum useful load’ (MUL) by Lassey et al. (2001). Table 4.1 supplies MULs for NIWA tubes. The MUL is proportional to the internal volume of the permeation tube at 344 mg(SF<sub>6</sub>) per ml at 39°C (calculated after Lassey et al., 2001). The minimum longevity of the SF<sub>6</sub>-charged tube – the time elapse before the MUL is reached – can be predicted from the linearly-regressed permeation rate. The actual longevity will be longer, due to permeation curvature.

Eqn 4.1 is a simple empirical model of permeation curvature whose parameters,  $a$  and  $b$  are deducible from a quadratic regression fit to the mass versus time curve (ignoring the settling period of 14 or more days, as noted in Section 4.3). Indeed, a quadratic relationship cannot be rigorous, as it would predict an eventual growth in mass. Lassey et al. (2001) found that the value of  $b$  varied markedly among ‘sibling tubes’ – tubes from the same batch of SF<sub>6</sub> fill – but that the ratio  $b/a$  – the relative change in permeation rate – varied less, and was proposed by Lassey et al. (2001) as a basis for retrospectively adjusting permeation rates for unrecovered tubes. Such adjustment is achieved by retaining ‘surveillance tubes’ as controls – drawn at random from sibling tubes and retained in the calibration environment throughout the experiment – whose ongoing weights are modelled by Eqn 4.1. The mean  $b/a$  ratio for those surveillance tubes is then presumed to also apply to unrecovered tubes for which  $b$  is unmeasured (Lassey et al., 2001).

Many non-linear models could be candidates for describing permeation curvature. Such a model might be guided by the underlying mechanism of permeation curvature, if it were understood, or by a putative mechanism. Recently, Moate et al. (2013) have formulated such a mechanistic model, showing that Michaelis-Menten kinetics can be used to accurately describe the release rate of SF<sub>6</sub> from permeation tubes over extended time periods. Using the initial charge of SF<sub>6</sub> and the initial rate of release of SF<sub>6</sub>, Moate et al. accurately predicted SF<sub>6</sub> permeation rates out to 600 days. This new approach may allow the SF<sub>6</sub> tracer technique to be used in serial experiments over at least a year, substantially reducing costs.

The quality of the linear regression fit during a calibration period should be a criterion for selecting ‘insertion tubes’ – tubes selected for *in vivo* experiments – from among a batch of sibling tubes (e.g.,  $R^2 > 0.9995$ ). If that quality cannot be attained, the earliest data should be removed from the regression fit, thereby extending the settling period until appropriate quality is assured (e.g., Fig 4.5). Extending the settling period may come at the expense of the calibration period, so with an established experiment date, ample time should be allowed (typically three months) when planning the tube fill. The

calibration period should not be less than six weeks and preferably not less than eight weeks (Figure 4.5)

It is presumed that the settling period is largely determined by the amount of impurities (H<sub>2</sub>O, CO<sub>2</sub>, etc) trapped in the tube, which would depend upon the circumstances of the fill. Each impurity co-permeates with SF<sub>6</sub>, thereby contributing to measured mass loss, until depleted to negligible levels.

With the quadratic model of Eqn 4.1, the SF<sub>6</sub> permeation rate  $Q_{SF_6}$  at time  $t$  is given by:

$$Q_{SF_6}(t) = \frac{-dW(t)}{dt} = a - 2bt \quad \text{Eqn. 4.2}$$

which empirically captures the observed declining permeation rate. In practice, for a calibration period  $T_{calib}$  of about six to 10 weeks, linear regression of  $W(t)$  versus  $t$  provides a very good fit (typical  $R^2$  exceeds 0.9995) with  $Q_{SF_6}$  as slope close to  $a$ , because  $b$  is very small ( $bT_{calib} \ll a$ ). However, as Figure 4.5 shows, the slope  $a$  can be biased high if the settling period is underestimated. Lassey et al. (2001) recommended that permeation rates deduced by linear regression could apply to insertion tubes in experiments conducted within about a month of calibration. Any protracted or subsequent experiments should take account of the permeation curvatures of those tubes, ideally through recalibrating the tubes if possible, but otherwise through adjustment based on the performance of surveillance tubes retained as controls in the calibration environment throughout the experiment.

Since 2001, when NIWA commissioned the larger cattle tubes, *in vitro* experiments with cattle tubes have been undertaken similar to the experiments reported by Lassey et al. (2001) with sheep tubes. Permeation curvature was also found, but for unknown reasons appeared to be less pronounced, with a smaller ratio  $b/a$ . For some batches,  $b$  was indiscernibly small, and a linear regression result remained robust for at least one year.

It is critical to the SF<sub>6</sub> tracer technique to be confident of extrapolating tube performance throughout the duration of the experiment or series of experiments. Thus it is strongly recommended that a SF<sub>6</sub>-charged permeation tube should not be used for serial experiments without recovery and recalibration between experiments. If this is not possible – when non-fistulated animals are used, for instance – then SF<sub>6</sub> permeation rates should be adjusted to allow for permeation curvature, either using empirical adjustments as reported by Lassey et al. (2001, Section 4), or better still, by using a more prolonged initial calibration that employs non-linear regression such as the quadratic regression of Eqn 4.1.

It is recommended that from every batch of permeation tubes, about 5% (preferred minimum of three) are selected randomly and retained in the calibration environment as controls, and their performances monitored throughout the experiment. The

performances of those 'surveillance tubes' provide confidence in the performances of 'insertion tubes', and enable adjustment for declining permeation rate as necessary (Lassey et al., 2001).

At Embrapa, Brazil, the 'long term' permeation tubes are calibrated for a minimum of eight weeks, keeping some representative tubes in calibration to eventually adjust the emission rates according to the observed curvature. This is analogous to the retention of what Lassey et al. (2001) term 'surveillance tubes'.

At Armidale, Australia, the high-flow tubes are typically weighed daily from days 2-12 after manufacture. Weights prior to day 6 are ignored, and a regression through weights on day 6 to 12 of emission is typically used to quantify permeation rate. The number of days of data for calibration can be extended (e.g., to day 14) if breath sampling is done over fewer days. The pattern of weight change in several surveillance tubes from the study of Hegarty et al. (2007) – which were retained in an incubator while other tubes were inserted in cattle – are shown in Figure 4.6.

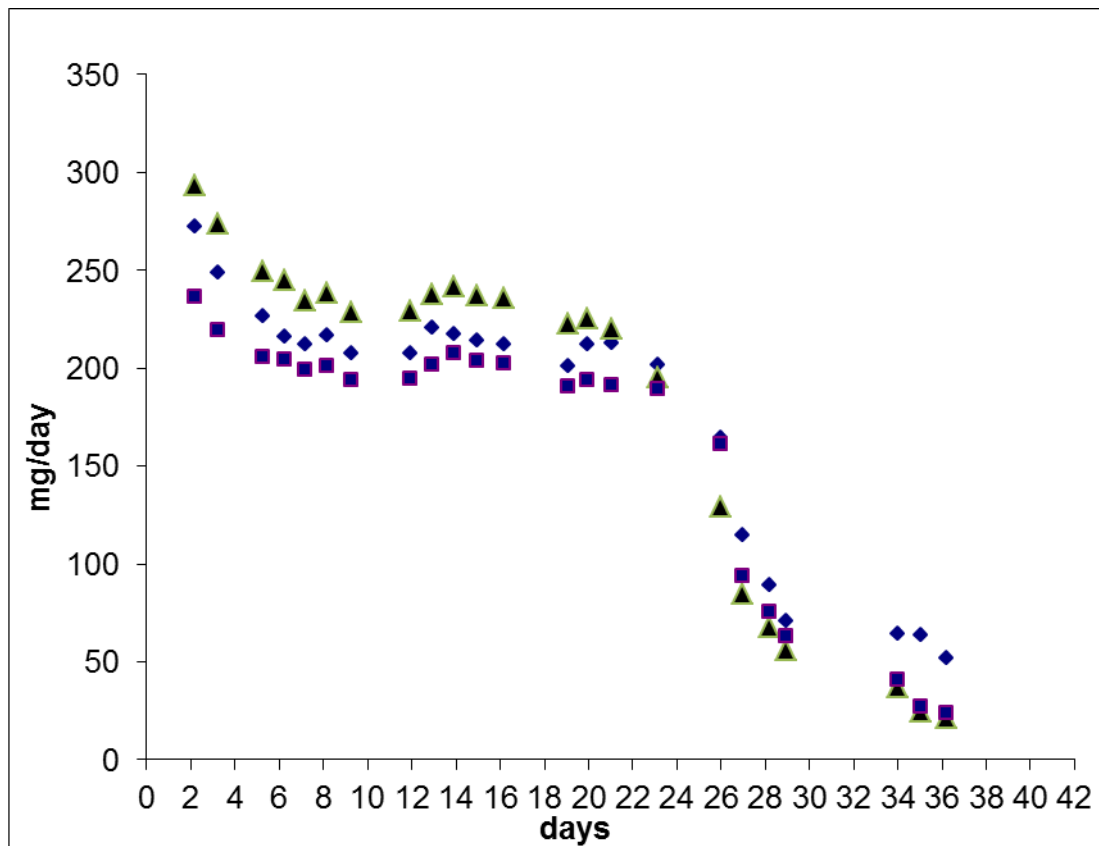

Figure 4.6: Release rate profile (mgSF<sub>6</sub>/d) for three high flow rate permeation tubes from which data on days 6–12 were used to estimate release rates.

*These control tubes were taken to the experimental site with tubes for insertion into cattle then returned to incubator to confirm that permeation rates were maintained until the end of the experiment.*

### ***Short-term changes to SF<sub>6</sub> permeation rate***

On a sub-daily time scale, Lassey et al. (2011) have questioned the usual assumption that a uniform release rate of SF<sub>6</sub> from a permeation tube results in a steady emission at each eructation cycle. For reasons still unclear, it appears that released SF<sub>6</sub> may accumulate within the rumen or elsewhere in the digestive tract for up to a few hours, until apparently stimulated by digestion to be co-emitted with eructated gases. This results in a strong correlation between CH<sub>4</sub> and SF<sub>6</sub> in the daily emission pattern (see also Chapter 10.2).

However, that correlation alone does not impair the utility of SF<sub>6</sub> as a tracer of enteric CH<sub>4</sub>. On the contrary, the fact that SF<sub>6</sub> emissions are strongly correlated with CH<sub>4</sub> emissions strengthens its merit as a tracer (Chapter 2), with the result that CH<sub>4</sub> estimates using the SF<sub>6</sub> tracer technique can be reliable even for breath accumulations as short as three hours (Lassey et al., 2011).

### ***Temperature dependence of permeation***

Permeation rates depend on temperature. Standard treatises express the temperature dependence through an equation such as the following (Namiešnik, 1984, Eq. 17):

$$\log \frac{Q_2}{Q_1} = 2950 \cdot \left( \frac{1}{T_1} - \frac{1}{T_2} \right) \quad \text{Eqn 4.3}$$

where  $Q_j$  is the permeation rate at absolute temperature  $T_j$  (°K). While this equation is empirical to an extent, it is based on Arrhenius relationships, and the factor 2950 is said to vary by ~10% with a different permeable medium and permeating gas. Oddly, what is seldom stated is the base of the logarithm in Eqn 4.3, whether a natural logarithm (when “ln” is often used in place of “log”), or of base 10 (log<sub>10</sub>, often abbreviated “log”). Such logarithms have a common ratio:  $\ln(x)/\log_{10}(x) = \ln(10) = 2.3026$ .

Namiešnik (1984) interprets Eqn 4.3 as indicating that “the value of the permeation rate varies by 10% with a change of temperature of 1°C” near an unspecified temperature; a statement which is more consistent with base-10 logarithms being intended. On the other hand, and apparently on the basis of direct experimentation, Bárbaro et al. (2008) have reported that the SF<sub>6</sub> permeation rate increases about 3% per °K over the range 308–316°K (35–43°C).

Very recently, Deighton et al. (2013b) have investigated the temperature dependence of SF<sub>6</sub> permeation rate about a temperature of 39°C, concluding that permeation rates increase with temperature by about 2.5% per °C, in good agreement with the finding of Bárbaro et al. (2008). This is consistent with natural logarithms being associated with the log function in Eqn 4.3.

Assuming a natural logarithmic interpretation of “log”, a differential form of Eqn 4.3 is:

$$\frac{1}{Q} \times \frac{dQ}{dT} = \frac{2950}{T^2}$$

Eqn 4.4

which clarifies that the relative change of  $Q$  with temperature,  $Q^{-1}dQ/dT$ , for  $T$  near 312°K would be about 0.03, or 3%.

Such temperature dependence of SF<sub>6</sub> permeation rate emphasises the need for accurate temperature control at calibration. In addition, it also emphasises that any between-animal variation in rumen temperature, or any temporal variation in rumen temperature, can potentially confound applications of the SF<sub>6</sub> tracer technique. However, short-term variations in rumen temperature of ±2°C (Al Zahal et al., 2008) are unlikely to be influential.

Detailed characterisation of permeation tube performance is important to gaining confidence in the efficacy of the SF<sub>6</sub> tracer technique, and in reducing uncertainty in CH<sub>4</sub> emission estimates.

It is useful if a batch of tubes prepared for a particular experiment have a narrow range of SF<sub>6</sub> permeation rates, so that inter-animal characteristics cannot be confused with inter-tube characteristics. This would require that the number of successfully-filled tubes far exceeds the number required – by typically 30% – in order to be able select from a narrow range of permeation rates.

The preference for such a narrow range is heightened by reports that CH<sub>4</sub> emission rates estimated by the SF<sub>6</sub> tracer technique might depend upon the individual SF<sub>6</sub> permeation rate (Vlaming et al., 2007; Pinares-Patiño et al., 2008; Martin et al., 2012), a finding that questions the merit of SF<sub>6</sub> as a conservative tracer of enteric CH<sub>4</sub>. In particular, Vlaming et al. (2007) reported a positive correlation between estimated CH<sub>4</sub> emission rate and SF<sub>6</sub> release rate for housed steers. However, such a correlation seems incompatible with results by Hegarty et al. (2007), who obtained plausible CH<sub>4</sub> emission estimates despite using permeation tubes that released up to 275 mg(SF<sub>6</sub>)/d, some 35 times the highest permeation rate used by Vlaming et al (2007). In addition, Meister et al. (2013) found a small negative but not significant correlation when using tubes of different permeation rates (by a factor of two) with the same animals (goats).

Moreover, the correlation reported by Vlaming et al. (2007) may have an alternative explanation. Lassey (2013) has demonstrated that the apparent correlation is sensitive to the choice of locations for background samplers, and that ill-chosen locations can lead to a spurious correlation. The optimal sampler locations are by themselves worth investigating in an animal house with limited ventilation, where concentration gradients of CH<sub>4</sub> and/or SF<sub>6</sub> can be appreciable (Chapter 7).



## 4.5 References

- Al Zahal O, Kebreab E, France J, Froetschel M & McBride B.W, 2008. Ruminal Temperature May Aid in the Detection of Subacute Ruminal Acidosis. *J. Dairy Sci.* 91, 202–207.
- Bárbaro, N, Gere, J, Gratton, R, Rubio, R & Williams, K, 2008. First measurements of methane emitted by grazing cattle of the Argentinean beef system. *N.Z J. Agric. Res.* 51, 209-219.
- Christian, G.D, 1971. *Analytical Chemistry*. Editor: Gordon Atkinson, University of Oklahoma. Ginn and Company, Oklahoma City, USA.
- Deighton, M.H, O'Loughlin, B.M, Buckley, F & Boland, T.M, 2011. A simple method for pre-calibration storage of sulfur hexafluoride permeation tubes. *Anim. Feed Sci. Tech.* 166–167, 198-200.
- Deighton, M.H, Williams, S.R.O, Lassey, K.R, Eckard, R.J, Boland, T.M & Moate, P.J, 2013a. Release rate of sulphur hexafluoride from permeation-tubes is not affected by submersion in water. *Adv. Anim. Biosci.* 4:269.
- Deighton, M.H, Williams, S.R.O, Lassey, K.R, Eckard, R.J, Boland, T.M & Moate, P.J, 2013b. Effect of temperature on the rate of sulphur hexafluoride release from permeation-tubes. *Adv. Anim. Biosci.* 4:416.
- Hegarty, R.S, Woodgate, R.T & Clark, D.A, 2003. Performance of high-flow permeation tubes releasing SF<sub>6</sub>. *Recent Adv. Anim. Nutr. Aust.* 14, 19A.
- Hegarty, R.S, Goopy, J.P, Herd, R.M & McCorkell, B, 2007. Cattle selected for lower residual feed intake have reduced daily methane production. *J. Anim. Sci.* 85:1479-1486.
- Iwaasa, A.D, Stumborg, M.A, Wittenberg, K.M, McGinn, S.M & McAllister, TA 2004. Development of a cost effective and simple sampling apparatus and PVC collection yoke system for methane measurement from grazing ruminants using the SF<sub>6</sub> technique. Canadian Society of Animal Science Conference on the Science of Changing Climates, Edmonton 20–23 July, 2004.
- Johnson, K, Huyler, M, Westberg, H, Lamb, B & Zimmerman, P, 1994. Measurement of methane emissions from ruminant livestock using a SF<sub>6</sub> tracer technique. *Environ. Sci. Tech.* 28, 359-362.
- Johnson, K.A, Westberg, H.H, Michal, J.J & Cossalman, M.W, 2007. The SF<sub>6</sub> technique: methane measurement from ruminants, In: Makkar, H.P.S, Vercoe, P.E (Eds.), *Measuring methane production from ruminants*, Springer, Dordrech, Netherlands, pp. 33-67.

Lassey, K.R, 2013. On the importance of background sampling in applications of the SF<sub>6</sub> tracer technique to determine ruminant methane emissions. *Anim. Feed Sci. Tech.* 180, 115-120.

Lassey, K.R, Ulyatt, M.J, Martin, R.J, Walker, C.F & Shelton, I.D, 1997. Methane emissions measured directly from grazing livestock in New Zealand. *Atmos. Environ.* 31, 2905-2914.

Lassey, K.R, Walker, C.F, McMillan, A.M.S & Ulyatt, M.J, 2001. On the performance of SF<sub>6</sub> permeation tubes used in determining methane emission rates from grazing livestock. *Chemosphere: Global Change Sci.* 3, 367-376.

Lassey, K.R, Pinares-Patiño, C.S, Martin, R.J, Molano, G & McMillan, A.M.S, 2011. Enteric methane emission rates determined by the SF<sub>6</sub> tracer technique: temporal patterns and averaging periods. *Anim. Feed Sci. Tech.* 166–167, 183-191.

Machmüller, A, & Hegarty, R.S, 2006. Alternative tracer gases for the ERUCT technique to estimate methane emission from grazing animals. *Int'l. Congress Series.* 1293, 50-53.

Martin, C, Rouel, J, Jouany, J.P, Doreau, M & Chilliard, Y, 2008. Methane output and diet digestibility in response to feeding dairy cows crude linseed, extruded linseed, or linseed oil. *J. Anim. Sci.* 86, 2642-2650.

Martin, C, Koolaard, J, Rochette, Y, Clark, H, Jouany, J.P, & Pinares-Patiño, C.S, 2012. Effect of release rate of the SF<sub>6</sub> tracer on methane emission estimates based on ruminal and breath gas samples. *Animal* 6, 518-525.

Meister, N.C, Lemos, N.L.S, Alari, F.O, Silva, V.C, Koury Filho, W, Malheiros, E.B, Frighetto, R.T.S & Ruggieri, A.C, 2013. Determination of methane production on grass fed goats. *Adv. Anim. Biosci.* 4:541.

Moate, P.J, Williams, S.R.O, Deighton, M.H & Hannah, M.C, 2013. Rate of release of SF<sub>6</sub> from permeation tubes is described by Michaelis-Menten kinetics. *Adv. Anim. Biosci.* 4:421.

Namieśnik, J, 1984. Generation of standard gaseous mixtures. *J. Chromatogr.* 300, 79-108.

Pavao-Zuckerman, M.A, Waller, J.C, Ingle, T & Fribourg, H.A, 1999. Methane emissions of beef cattle grazing tall fescue pastures at three levels of endophyte infestation. *J. Environ. Qual.* 28, 1963-1969.

Pinares-Patiño, C, D'Hour, P, Jouany, J-P & Martin, C, 2007. Effects of stocking rate on methane and carbon dioxide emissions from grazing cattle. *Agric. Ecosyst. Environ.* 121, 30-46.



Pinares-Patiño, C.S, Machmüller, A, Molano, G, Smith, A, Vlaming, J.B, & Clark, H, 2008. The SF<sub>6</sub> tracer technique for measurements of methane emission from cattle — effect of tracer permeation rate. *Can. J. Anim. Sci.* 88, 309-320.

Rochette Y, Eugène M, Doreau M, Morgavi D.P & Martin C, 2012. Determination of enteric methane emission by SF<sub>6</sub> tracer technique: permeation tubes must be calibrated after incubation in the rumen for an accurate quantification. International Symposium on Emissions of Gas and Dust from Livestock, 10–13 June 2012, Saint-Malo, France, 125-129.

Vlaming, J.B, Brookes, I.M, Hoskin, S.O, Pinares-Patiño, C.S & Clark, H, 2007. The possible influence of intra-ruminal sulphur hexafluoride release rates on calculated methane emissions from cattle. *Can. J. Anim. Sci.* 87, 269-275.

## 5 SAMPLING SYSTEMS

M.H. Deighton<sup>a\*</sup>, S.R.O. Williams<sup>a</sup>, P.J. Moate<sup>a</sup>, J.I. Gere<sup>b</sup>, C. Martin<sup>cd</sup>, R.J. Martin<sup>e</sup> & A.D. Iwaasa<sup>f</sup>

<sup>a</sup>Department of Environment and Primary Industries (DEPI), Ellinbank, Victoria, Australia

<sup>b</sup>La Universidad Nacional del Centro de la Provincia de Buenos Aires, Tandil Bs. As., Argentina

<sup>c</sup>INRA, UMR1213 Herbivores, Saint-Genès-Champagnelle, France;

<sup>d</sup>Clermont Université, VetAgro Sup, UMR1213 Herbivores, Clermont-Ferrand, France

<sup>e</sup>National Institute of Water and Atmospheric Research, Wellington, New Zealand

<sup>f</sup>Agriculture and Agri-Food Canada/Agriculture et Agroalimentaire Canada - Semiarid Prairie Agricultural Research Centre, Saskatchewan, Canada

\*Corresponding Author: M.H. Deighton [matthew.deighton@depi.vic.gov.au](mailto:matthew.deighton@depi.vic.gov.au)

---

Research groups have developed various breath-sampling systems – both passive and active – using SF<sub>6</sub> as a tracer. In all cases, the aim is to reliably collect a time-averaged (continuous) air sample from a location near a ruminant's muzzle.

Most systems consist of a flexible sample collection tube, which extends from a collection point at the animal's muzzle to a sample collection vessel, secured to the animal in a halter or harness. Typically, a filter in the sample collection tube removes airborne particles that might otherwise block it. Sampled air is drawn either passively via vacuum, or actively via a pump, into the collection vessel.

In passive sampling, the collection rate is limited using a flow restriction, such as a capillary tube located between the sample collection point and the collection vessel. Collected gas samples must contain sufficient concentrations of methane (CH<sub>4</sub>) and SF<sub>6</sub> to enable reliable determination of those concentrations during analysis, usually via gas chromatography.

An important feature of SF<sub>6</sub> tracer techniques is the ability to collect samples from individual animals without having to confine them. One implementation of a SF<sub>6</sub> tracer technique has been described by Johnson et al. (2007) and detailed online (Johnson and Westberg, 2006). This chapter describes the gas sampling apparatus, and equipment used to support its deployment by a range of international research

groups. A summary of the main attributes of various SF<sub>6</sub> sampling systems implemented internationally is shown in Table 5.1.

Throughout this chapter, the vacuum and/or pressure within collection vessels used in passive SF<sub>6</sub> sampling systems is specified in standard international units (kilopascals; kPa). For clarity, vacuum and pressure is described as measured (gauge value); that is, relative to standard atmospheric pressure (101.3 kPa), rather than as absolute pressure (i.e., a vacuum of 95 kPa is equal to an absolute pressure 95 kPa less than atmospheric pressure).

## 5.1 Sampling location

Air samples are normally collected from a point just above the animal's nostrils (Figure 5.1). This location enables sufficient sampling efficiency of expired and eructated gases in ambient air, while reducing the chances of blockage of the sampling apparatus during feeding and drinking.

Common causes of sampling failure are blockage of the air inlet by particles of feed or soil, water blockage during drinking, and the capture of water vapour, which can condense, blocking the flow restrictor.

Design of the sampling apparatus varies, but typically includes single sampling points, branched inlets and loops. Most systems utilise a 3.17 mm flexible tube to transport collected gases from the sampling point to the collection vessel, as well as some means of filtering the sampled air to prevent blockage of the flow restrictor.



Figure 5.1: Examples of sampling points for the collection of air samples.

*(L to R): Agriculture and Agri-Food Canada, Semiarid Prairie Agricultural Research Centre; Universidad Nacional del Centro de la Provincia de Buenos Aires; Department of Environment and Primary Industries, Ellinbank, Victoria, Australia.*

**Table 5.1: A summary of the characteristics of various established sampling systems for use with cattle.**

Collection vessel		Vacuum (kPa)		Flow		Initial flow (SCCM)	Collection duration (d)	Location			
Material	Shape	Volume (L)	Quick connect	Valve	Sample port				Pre-collection	Post-collection	Restrictor
PVC	U yoke	2.0	Yes	No	Yes	84	50 - 65	Capillary 0.004" ID 900 mm, coiled	0.37	1	Agriculture and Agri-Food Canada
PVC	V yoke or cylinder	0.7 or 2.5	Yes	No	No	80-90	40-50	Capillary, 0.004" ID	0.25 or 0.8 or 1.6	0.5 or 1	INRA Herbivores France
Stainless steel	Cylinder	0.5	Yes	No	No	ns	50	Ball bearing in tube union	0.35	1 or 5	Univ. Nac. Del Centro de la Pcia. De Bs. As. Argentina
Stainless steel	Cylinder	0.8	Yes	No	No	97	65	Capillary 0.005" ID 30 mm, crimped	0.2	1	Department of Primary Industries, Victoria Australia
PVC	U	2.14	Yes	No	No	90	60-65	Capillary 12.7 µm ID 20 mm, crimped	0.5	1	Teagasc and University College Dublin Ireland
PVC	V yoke	2.5	Yes	No	No	97	60 - 65	Capillary 0.004" ID 10cm crimped	0.9	1	NIWA and AgResearch New Zealand

SCCM, standard cubic centimetres per minute; ID, internal diameter; ns, not specified.

### **Passive collection**

Apparatus used for passive sample collection includes an evacuated collection vessel, some means of restricting the flow into the vessel and a filter to prevent obstruction of the flow restrictor.

### **Collection vessel**

The size and shape of the collection vessel depends on where it is mounted on the animal. In the original method described by Johnson et al. (1994), the collection vessel was a one-litre stainless steel sphere. Since then, researchers have developed various other shapes and sizes (Figure 5.2). V- or U-shaped yokes have been used in collection vessels positioned over an animal's neck (Johnson et al. 2007). Stainless steel cylinders are more commonly used when the collection vessel is mounted behind the animal's head, while an elongated U shape has been used when the collection vessel is fitted to the animal's back (Deighton et al. 2013)

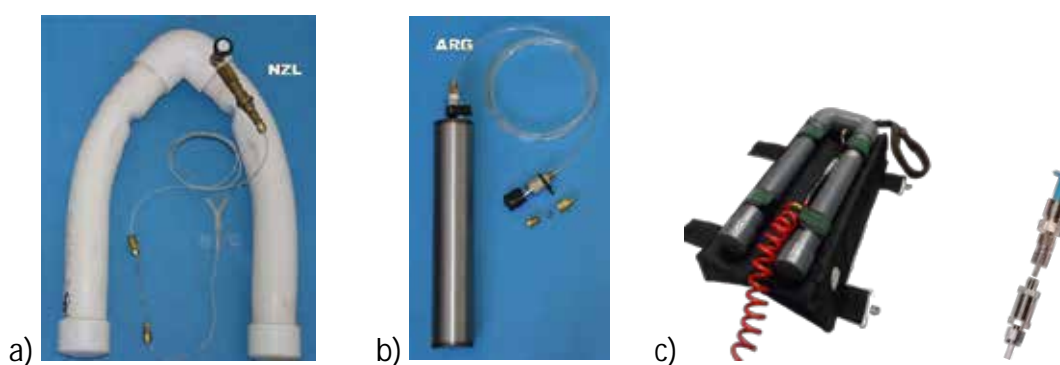

**Figure 5.2: Sampling apparatus used at various research locations internationally.**

*a) PVC yoke (1.7 L for sheep, 2.5 L for cattle) for neck mounting, complete with 1.59 mm swagelok quick connect coupling, 3.17 mm PFA sample transport tube, 1.59 mm external crimped capillary tube and branched Y sampling point (Department of Animal Sciences, Washington State University, USA. NIWA and AgResearch, New Zealand).*

*b) Stainless Steel canister (0.5 L) for halter mounting; complete with ball bearing inflow regulator and double filter, an inner layer of hypoallergenic tape and an external layer of permeable hydrophobic tissue (Universidad Nacional del Centro de la Provincia de Buenos Aires).*

*c) PVC U-shaped canister (2.14 L) for back mounting, complete with padded backpack, 3.17 mm swagelok quick connect coupling, internal 1.59 mm crimped capillary tube, 15 micron air filter, 3.17 mm PFA sample transport tube and 6.35 mm red tube protection coil (Teagasc Moorepark Dairy Research Centre, Ireland).*

## 5.2 Configuration of sampling apparatus

A variety of equipment configurations has been used to transfer gas from the sampling point to the collection vessel, typically by a flexible tube of 3.17 mm outer diameter and made from either nylon or Perfluoroalkoxy (PFA). Some researchers have used ¼" diameter polyethylene tubing. Examples of gas sampling and collection apparatus are shown in Figures 5.3, 5.4 and 5.5.



**Figure 5.3: Air filter, flow restricting capillary tube and quick connect stem assembly used at the Department of Environment and Primary Industries, Victoria, Australia.**

1. Filter: 15 micron (B-2F-15; Swagelok, Solon, OH, U.S.A.) note direction arrow.
2. Nylon ferule set: (NY-200-SET; Swagelok, Solon, OH, USA)
3. Nut: (B-202-1; Swagelok, Solon, OH, U.S.A.)
4. Nylon tubing: 750mm long, ⅛" OD, 0.08" ID (Ledalon 12; Leda extrusions NZ Ltd., Upper Hutt, New Zealand).
5. Brass ferule set: (B-200-SET; Swagelok, Solon, OH, USA)
6. Capillary tube (crimped): 30mm long (56712-U; Supelco, Bellefonte, PA, USA). Note that the crimped end is the end away from the nylon tubing.
7. Snap connector: Brass QC4 (B-QC4-S-200; Swagelok, Solon, OH, USA)

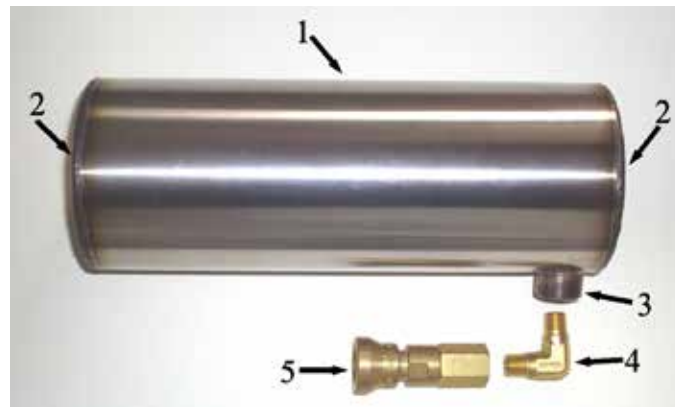

Figure 5.4: A 0.8 L stainless steel collection vessel used at the Department of Environment and Primary Industries, Victoria, Australia.

1. *Body: 75mm diameter x 200mm long, 304 stainless steel tube.*
2. *End cap: 1.5mm thick 304 stainless steel, cut to match tube end.*
3. *Boss: To suit male elbow, installed 10mm proud of tube*
4. *Male elbow: 1/8" NPT brass (B-2-ME; Swagelok, Solon, OH, USA.)*
5. *Quick connect: Swagelok Brass QC4 Body (B-QC4-B-2PF; Swagelok, Solon, OH, USA)*



Figure 5.5: Sample collection apparatus used at the Agriculture and Agri-Food Canada, Semiarid Prairie Agricultural Research Centre.



The Agriculture Canada sampler utilises an evacuated PVC yoke with a 90 cm long coil of stainless steel capillary tube as the inflow restrictor. The coiled capillary tube, with inner diameter of 0.004 – 0.006 mm, is protected inside a plastic sleeve, and the 3.17 mm PTFE air sampling tube is also protected within a more robust outer tube attached to a Nylon horse halter. Air collection tubes and an inline particle filter (Swagelok B-2F-15) are located near the nose by a nose flap attached to the halter. The capillary tube with outer diameter of 1.58 mm is connected to the PTFE sampling tube using a reducing union (Swagelok B-200-6-1), while the outer protective tube is attached to the plastic sleeve using Oetiker clamps (18-OET).

Collection vessels have been constructed from both stainless steel and polyvinylchloride (PVC). PVC has been used when weight, cost or shape have been important criteria. When durability is the prime concern, stainless steel is more suitable. Choice of vessel shape also influences choice of construction material: for example, stainless steel is relatively easy to use in simple cylinders, but PVC is more amenable to the creation of complex shapes.

Researchers at DPI, Victoria no longer use neck-mounted PVC yokes for dairy cows, as these broke frequently and their daily replacement was time consuming. Instead, they use stainless steel canisters, which have proven remarkably robust and faster to handle.

The capacity (volume) of collection vessels is a compromise between the desired sample quantity, the sampling rate that can be reliably achieved and the intended location of the collection vessel on the animal. Capacities used range from 0.5 L to 5.0 L (Gere and Gratton, 2010; Hegarty et al. 2007).

The standard gas-tight union used between the evacuated collection vessel and the sample collection tube is the Swagelok Quick Connect from the QC4 series (Swagelok, Solon, OH, USA). This removes the need for a separate tap, as a shut-off valve in the QC4 body automatically engages when it is decoupled from the QC4 stem (Figure 5.6).

### ***Connecting and Disconnecting QC4 Quick Connect Components***

To couple the Quick Connect the stem is aligned with the body and pushed into the body until the body sleeve moves away from the stem and clicks into place (Figure 5.6). The movement of the body sleeve when connected provides an easily visible cue to verify a correct connection. To uncouple pull the body sleeve towards the stem.



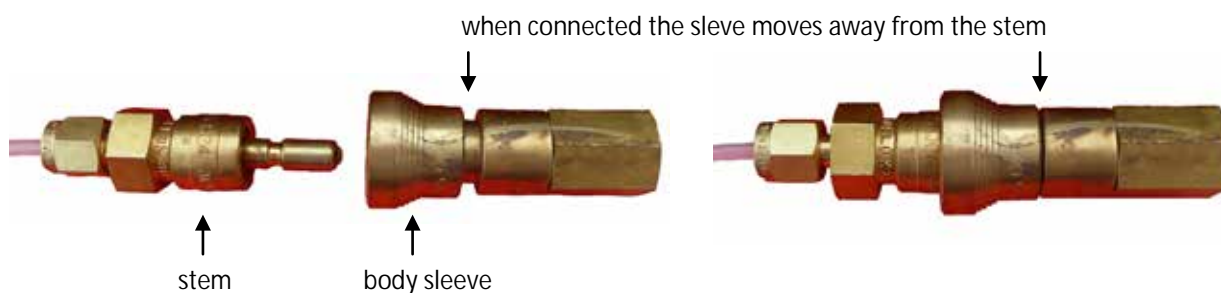

Figure 5.6: QC4 Quick Connect components; stem (left) and body (Swagelok, Solon, OH, USA).

### *Cleaning Swagelok QC4 Quick Connect Bodies*

Cleaning the valves in Swagelok QC4 body is simple, but reassembly requires care. The suggested process is as follows: carefully open the body of the QC4 and identify the parts (Figure 5.7). The conical recess of the valve base and the o-ring of the valve can be cleaned by wiping with a lint free paper towel or cloth. Once the sealing surfaces are clean, reassemble the QC4, paying particular attention to the sequence and orientation of the parts. After reassembling the quick connect, test for leaks.



Figure 5.7: The parts of a QC4 quick connect body (Swagelok, Solon, OH, USA).

- connector end, , valve base, *f* valve, „ spring, ... base.

### *Flow restriction*

The rate and duration of air collection must be matched to the volume of the collection vessel to ensure an acceptable decrease in vacuum (and consequently flow rate) over the desired collection period.

Flow restriction can be created in a number of ways: successful solutions include stainless steel capillary tubing 0.005" ID, 1.59 mm OD (56712-U; Supelco, Bellefonte, PA, USA), in which the length determines the flow rate (Figure 5.8: Johnson et al. (1994)); a short length of capillary tubing crimped almost shut to match the desired flow rate (Figure 5.9: Wims et al. (2010)) and a ball bearing pressed against the base of a tube union fitting with sufficient force to achieve a desired flow rate (Figure 5.10: Gere and Gratton (2010)).



Figure 5.8: Capillary tube

---



Figure 5.9: Crimped capillary

---

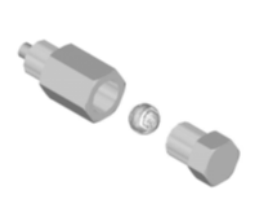

Figure 5.10: Ball bearing

---

### Setting flow rate

The airflow rate through each flow restrictor should be set at a common vacuum. Ideally, the initial collection vessel vacuum would be used (e.g., 95 kPa). Vacuum should be determined using an accurate gauge: at DPI Ellinbank, the vacuum in collection canisters is measured using a digital test gauge (XP2i-DP; Crystal Engineering, San Luis Obispo, CA, USA).

A flow meter measures the flow rate in standard cubic centimetres per minute (SCCM), through a capillary at standard temperature and pressure. At DPI Ellinbank, a digital flow meter corrects for ambient temperature and pressure (EW-32908-53; Cole-Parmer, Vernon Hills, IL, USA). The flow meter must be positioned on the atmospheric side of the flow restrictor, not the vacuum side (Figure 5.11), where it would overestimate the true flow rate (SCCM). This is because the pressure (vacuum) of the measured flow will differ significantly from the ambient atmospheric pressure about the flow meter.



**Figure 5.11:** A flow meter must be on the atmospheric side of the restrictor when measuring flow.

Once the desired flow of a capillary tube is known to be given by a set length (an 80 cm length, for instance, will typically be associated with 0.9 SCCM), new restrictors can then be created simply by cutting additional pieces to the set length, then checking for actual flow rate.

For crimped capillaries, the crimping needs to be done while the flow is being measured in real time. The short length of capillary is crimped using a narrow-jawed vice or lever action pliers (such as vice grips) until the desired flow is achieved when

the crimping force is released. If the flow is too low, it can be increased by gently crimping the capillary at 90° to the first crimp point.

For the ball bearing technique (Gere and Gratton, 2010), a torque of ~1 Nm on the hexagonal head of the screw top is enough to reduce the flow to the desired range. Then, the restrictor is inserted as a leak toward atmosphere in a small vacuum system with a known volume (~30 mL), evacuated with a mechanical pump. A capacitive gauge gives the pressure. After a first online adjustment based on the minimum pressure attainable during pumping, pumping is stopped by closing a valve, and the inflow rate is determined typically by measuring the pressure rise-time from 0.3 to 0.5 bar – about 20 s. This fast determination of the conductance allows further adjustments when necessary.

#### Protection of flow restrictors

Regardless of design, all restrictors must be protected from blockage by particles or moisture.

For systems with inline flow restriction, a filter is installed upstream of the restrictor. Air filtration is commonly achieved using an inline particulate filter with a 15-micron pore size (e.g., B-2F-15; Swagelok, Solon, Ohio, U.S.A.). Filters are commonly located at the air inlet, or immediately prior to the point of flow restriction – sometimes in both locations.

A different approach was used for Gere and Gratton's ball bearing restrictor (2010), because it is situated at the end of the sampling line. A double filter consisting of an inner layer of hypoallergenic tape and an external layer of permeable hydrophobic tissue has been used. Immersion in water for about 15 min did not appreciably change the inflow rate. However, long exposure to wet conditions can result in blockage of the restrictor.

Capillaries need mechanical protection from bending, since any change in the inner diameter of the tube will change the flow rate. Solutions include housing a length of coiled capillary tube inside a plastic housing (Figure 5.12), and fitting the capillary inside the collection tube such that it resides within either the air filter (Figure 5.13) or male Quick Connect fitting.



Figure 5.12: Coiled capillary can be housed inside a PVC tube for protection.

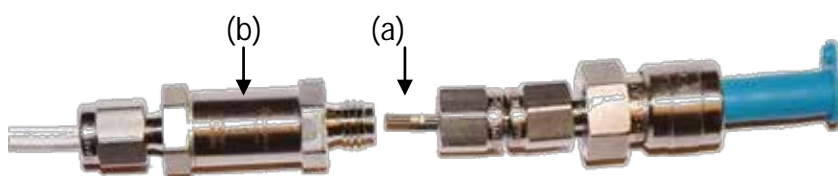

Figure 5.13: A 15mm length of 1.59 mm crimped capillary tube (a) fitted inside a Swagelok air filter (b) and 1/8" tube using nut and ferrule tube connections (Swagelok, Solon, OH, USA).

*Note protective cap fitted to prevent dust contamination via the QC4 stem.*

#### Location of flow restriction

There is debate about the best place to locate the flow restrictor. Some researchers place the restrictor at the sample collection end of the sampling tube, while others place it at the collection vessel end. In theory, there should be no difference. In practice, however, placing the restrictor near the sample collection point subjects all joints and tubing between the restrictor and the collection vessel to vacuum, raising the possibility of leaks. If the restrictor is located adjacent to the collection vessel, there is a possibility that air may flow bi-directionally within the sampling tube.

However, that is unlikely, so long as the internal diameter of the sampling tube is small. For example, 3.17 mm nylon tube commonly has an internal diameter of about 2 mm. At a flow of 0.5 SCCM, the velocity of gas within the tube will be about 15 cm/min. If a larger diameter tube were used, the velocity would be less, making bi-directional flow possible, but still unlikely (for 1/4" tube with internal diameter around 4.3 mm and a flow of 0.5 SCCM, the velocity would be 3.4 cm/min).

Systems that locate the restrictor as close as possible to the collection vessel reduce the opportunity for leaks, especially where the flow restrictor is positioned as an integral component of the air filter or Quick Connect coupling. Use of 3.17 mm tubing (with a small internal diameter) creates a flow velocity such that bi-directional flow in the sampling tube is not possible.

### ***Head halters and back mounted harnesses***

Halters of various designs are used to mount gas-sampling apparatus on the head of animals, and position the sampling point above the nostrils. Sample collection canisters have been fitted in various positions – as a yoke over the neck of an animal or as canisters fitted to the head halter (Figure 5.14) – and have been mounted on shaped backpacks and flexible saddles (Figure 5.15).



**Figure 5.14: Various canister mounting positions.**

---

*(L to R) neck yoke (Department of Environment and Primary Industries, Victoria, Australia) and Halter (Universidad Nacional del Centro de la Provincia de Buenos Aires; Department of Environment and Primary Industries, Victoria, Australia).*





Figure 5.15: Two types of back-mounting system for collection vessels

(L to R): Padded backpacks on cows with U-shaped 2.14 L PVC canisters (Teagasc Moorepark Dairy Research Centre, Ireland) and flexible saddles on cows with 0.8 L stainless steel canisters (Department of Environment and Primary Industries, Victoria, Australia).

### 5.3 Sample collection procedure

#### *Cleaning collection canisters to remove residual gases*

Prior to air sample collection, it is necessary to ensure that the evacuated vessels used are free of residual CH<sub>4</sub> and SF<sub>6</sub> from their previous use. Deighton et al. (2011) demonstrated that re-use of sampling canisters without an effective cleaning procedure resulted in the retention of a detectable residue of both CH<sub>4</sub> and SF<sub>6</sub>. They performed a repeat analysis of gas from canisters following a single evacuation and re-filling with N<sub>2</sub> (999.99 g/kg N<sub>2</sub>). This enabled determination of the residual gas retained in canisters. It was found residual gas concentrations are proportional to the gas concentration of the previous sample collected into the canister (Figure 5.16).

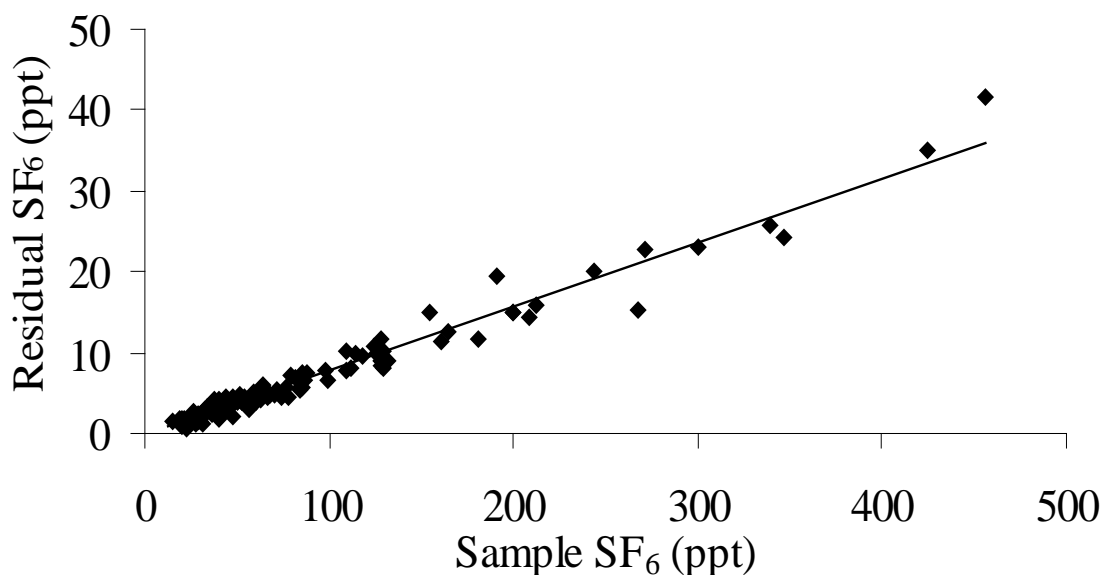

Figure 5.16: A single evacuation of a collection vessel can leave a residue in proportion to the concentration of gases in the previous sample - from Deighton et al. (2011).

Residual gas can have a large effect on the accurate correction for background concentrations of SF<sub>6</sub> and CH<sub>4</sub>. Residual gas will increase the measured concentration of gases within subsequent samples collected into the same vessel, and potentially increase or decrease the resulting CH<sub>4</sub>:SF<sub>6</sub> ratio. This causes an erroneous sample concentration when the previous sample collected into a given vessel has a higher mixing ratio, and the CH<sub>4</sub>:SF<sub>6</sub> ratio differs from the true ratio of the subsequent sample.

To ensure each sample collection is independent from previous use, residual gas must be purged from vessels. This is done by repeated evacuation and flushing of canisters with a clean gas source free of SF<sub>6</sub> and CH<sub>4</sub>. A specific flushing protocol should be developed at each research site, and the protocol must be demonstrated to effectively remove residual gas from vessels with the highest expected gas mixing ratio.

Evacuating collection vessels to a vacuum < 95 kPa will minimise the number of flushes required within a given protocol. While it is possible to remove residual gases from collection vessels by complete, or near-complete, evacuation, this is rarely achieved in practice (Table 5.1). Researchers need to be aware of the potential for residual gas error, and evaluate their system to determine if canister flushing or complete evacuation is the most time-efficient way to remove residual gases before collecting samples.

### ***Preparation of collection vessels***

Before use, collection vessels need to be evacuated and tested for leaks. Evacuation is usually achieved using a mechanical vacuum pump. Ideally, the vacuum should be



maximised (greater than 95 kPa vacuum), so as to reduce contamination or dilution by air remaining in the collection vessel. Importantly, the initial vacuum should be maximised to provide the longest sampling period possible at a vacuum of >50 kPa.

Collection vessels can be tested for leaks by evacuating them, recording the initial vacuum using a digital meter, then waiting for twice the intended sampling duration before measuring the remaining vacuum. This must be done with with an accurate device, such as a Digital Test Gauge (XP2i-DP; Crystal Engineering, San Luis Obispo, CA, USA). Any decline in vacuum indicates a leak. The valve in the Swagelok QC4 body is a potential source of leaks following extensive use, or use in dusty conditions.

### ***Sampling rate***

Contrary to the established dogma that evacuated canisters are filled at a constant or steady rate (Johnson et al. 1994; Johnson and Johnson 1995; Johnson et al. 2007), flow restrictors used within passive sampling systems result in a declining rate of sample collection. Sampling rate declines with the decline in vacuum in the collection vessel, because airflow is a function of the pressure difference across the flow restrictor (Gere and Gratton, 2010). The decline in sampling rate is supported by empirical data collected at DPI Victoria (Figure 5.18).

The pressure difference across the flow restrictor, created by the remaining vacuum in the collection vessel, decreases with time as collected air fills the vessel. The decline in sample inflow rate (sampling rate; SCCM) over the course of the collection period – typically 24 hours – produces a time-related bias in sampling. More sample volume (ml) is collected for a given duration (min) when a collection vessel is first activated than just prior to its retrieval at a lower vacuum level. Thus, gases emitted earlier in the sample collection period contribute a greater proportion of the total time-averaged sample than those emitted late in the collection period.

To minimise the sampling bias generated within a collection period, air flow rate (SCCM) should be matched through the flow restrictor to sample canister volume: this ensures that, following the sample collection period, the remaining canister vacuum is no less than 50 kPa (Johnson et al. 2007) as indicated by the dotted line shown in Figure 5.17.

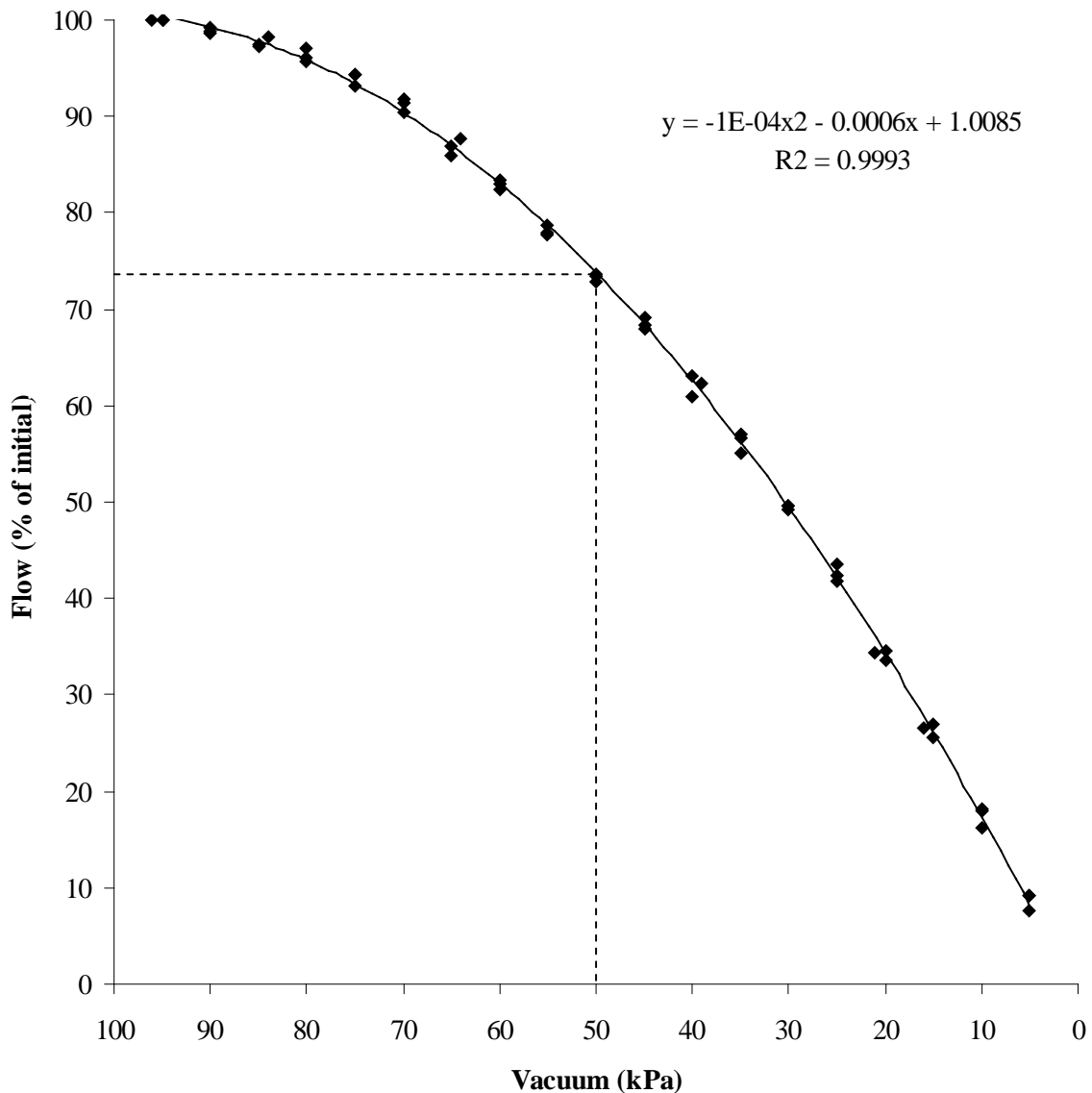

Figure 5.17: Flow rate through crimped capillaries declines with decline of vacuum in the collection vessel. Dotted line indicates ~27% flow reduction at 50 kPa; the point at which collection is commonly terminated with capillary sampling systems. (Empirical data from Department of Primary Industries, Victoria, Australia).

### *Time of sample collection canister change*

Time-averaged gas sampling within the SF<sub>6</sub> tracer technique relies on collecting an equal quantity of gases at all times throughout the sampling period (typically 24 h). As such, gases sampled at any time should contribute an equal proportion of the total gas collection for the sampling period. It can be seen that passive collection is an imperfect time-averaged sampling system, because the rate of sample collection is not constant (Figure 5.17). For this reason, the time of day (stage of collection period) when collection vessels are changed could bias the calculated result, especially if animals

have distinct bouts of feeding, and subsequently a diurnal pattern of CH<sub>4</sub> emission in a 24-hour cycle.

Consider the diurnal methane flux (Figure 5.18): if collection vessels were changed at 07:00 (when feeding often begins, and peak rates of CH<sub>4</sub> are produced), then the greatest sampling rate occurs when CH<sub>4</sub> emission is greatest (0 to 12 h) and the least sampling rate occurs when CH<sub>4</sub> emission is lowest (12 to 24 h). This would tend to lead to an overestimation of the true CH<sub>4</sub> emission per day. Similarly, if the collection vessel was changed at 19:00, there could be an underestimation of daily CH<sub>4</sub> emission.

Lassey et al (2011) reported that SF<sub>6</sub> is not emitted from sheep at a uniform rate, but its daily emission pattern was strongly correlated ( $R^2 = 0.732$ ) with methane emission. Should this observation hold for all animals, this co-emission of CH<sub>4</sub> and SF<sub>6</sub> can be expected to reduce – but not eliminate – the error caused by an imperfect time-averaged sampling procedure, while also being a source of individual animal variation.

Good scientific practice dictates that collection vessel changeover should be timed so that, within each measurement period, all animals and treatments are compared equally, thereby reducing any sampling bias among animals and treatments.

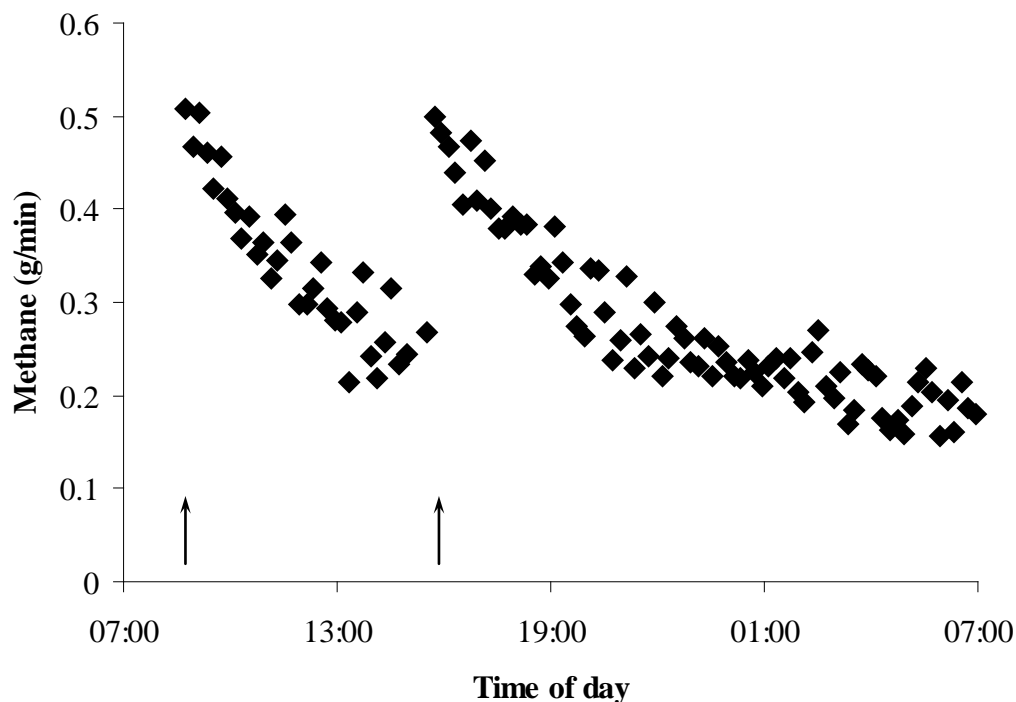

Figure 5.18: CH<sub>4</sub> peaks at feeding, then declines when dairy cows are fed twice per day (Empirical respiration chamber data from Department of Environment and Primary Industries, Victoria, Australia, arrows indicate feeding times).

It is important to note that the exact time of canister connection and disconnection is unrelated to the calculated rate of daily CH<sub>4</sub> emission (g/d). Sample collection should

be initiated and stopped at approximately the same time of day for each animal in each collection period used. This time should be the same, relative to any important events such as feeding or treatment administration, to ensure that each sample collection period is an equal replicate of each animal's daily routine. However, the duration of sample collection does not influence the calculated rate of CH<sub>4</sub> emission (see Chapter 10).

### ***Example sample collection protocol***

Prior to start of measurement period:

- Sample collection canisters are tested to ensure they do not leak under vacuum. Canisters are evacuated to a vacuum of approximately 95 kPa. Vacuum is measured using a digital test gauge, such as the XP2i-DP (Crystal Engineering, San Luis Obispo, CA, USA), and recorded. Canisters are stored for 48 h prior to measurement of remaining vacuum to determine vacuum loss.
- In-line particulate filters are cleaned and dried. This is achieved by soaking in ethanol for 24 hours, then flushing 20 ml of ethanol through each filter, in the reverse direction to air flow, using a syringe. Excess ethanol is removed by backflushing with nitrogen gas or air, prior to drying at about 65°C for 24 h.
- Each sample collection apparatus is assembled and checked to ensure all connections and tubing are in good working order. The sampling rate of each assembled apparatus – measured in standard cubic centimetres per minute (SCCM; at standard temperature and pressure) – is tested using a digital flow meter, such as the EW-32908-53 (Cole-Parmer, Vernon Hills, IL, USA), which corrects for ambient temperature and pressure, while connected to a collection canister with vacuum equal to the intended initial sampling vacuum (95 kPa).
- Sample collection canisters are cleaned following a site-specific protocol, verified to ensure all residual CH<sub>4</sub> and SF<sub>6</sub> is removed from canisters.
- Sample collection canisters are evacuated to approximately 95 kPa vacuum in preparation for use.
- Animals are fitted with training halters and/or canister supporting saddles to familiarise them with the equipment prior to the measurement period.

During the measurement period:

- Animals are fitted with the full sampling apparatus in preparation for initiation of sampling.
- The initial vacuum of sample collection canisters allocated to each animal is measured using a digital test gauge, then each canister is connected to the sampling apparatus to initiate sample collection.
- After 24 h, the collection canister is removed and post-collection vacuum is measured using a digital test gauge and recorded.

- Any leaking or blocked sampling apparatus identified by the post-collection vacuum check are replaced with spare apparatus, prepared following steps 2 and 3 above.
- Another evacuated canister is attached to begin the next consecutive 24-hour sampling period.

### **Data collection and processing**

Data collection for the calculation of CH<sub>4</sub> emissions begins during the sample collection process. Typically, a data recording sheet is used for each day of sample collection. This sheet accompanies each set of gas collection canisters from their pre-sampling preparation to final gas analysis, and contains a full record of activity relating to each sample's collection and analysis.

An example of how this information can be categorised and used to calculate CH<sub>4</sub> emission and yield from a passive sampling system is provided below. This example includes data typical of that collected from dairy cattle at the Department of Environment and Primary Industries Victoria, Australia (DEPI), and sheep by NIWA, New Zealand (K.R. Lassey *pers comm.*). Worked examples of important equations are provided, as used by researchers at DEPI. For the purposes of these examples, data are presented for a single animal sample and single background canister.

Under normal experimental conditions, the concentration of gases in background air is determined as the mean concentration from several background sampling canisters, sited to collect air representative of that surrounding experimental animals (Chapter 8). For easier interpretation, vacuum and/or pressure within collection vessels is specified as measured (kPa; gauge value); that is, relative to standard atmospheric pressure (101.3 kPa).

### **Sampling details**

#### **Animal sample**

Collection day no.	Date	Animal ID	Treatment	Permeation tube ID	SF <sub>6</sub> release rate (mg/d)	Restrictor ID	Measured restrictor flow (SCCM)
<i>Recorded</i>	<i>Recorded</i>	<i>Recorded</i>	<i>Recorded</i>	<i>Recorded</i>	<i>Calculated</i>	<i>Recorded</i>	<i>Measured</i>
d	dd/mm/yyyy	Cow ID	Control	ID No.	7.4	Cap-ID	0.25
d	dd/mm/yyyy	Sheep ID	Control	ID No.	0.90	Cap-ID	0.60

#### **Background sample**

Collection day no.	Date	Background Location	Position	Restrictor ID	Measured restrictor flow (SCCM)
<i>Recorded</i>	<i>Recorded</i>	<i>Recorded</i>	<i>Recorded</i>	<i>Recorded</i>	<i>Measured</i>
d	dd/mm/yyyy	Outdoor	West	Cap- ID	0.27
d	dd/mm/yyyy	Outdoor	East	Cap- ID	0.6

### Daily sample collection details

#### Animal sample

Canister ID	Canister volume (cc)	Collection start time	Collection end time	Sampling duration (min)	Expected final vacuum (kPa)	Initial canister vacuum (kPa)	Final canister vacuum (kPa)
<i>Recorded</i>	<i>Recorded</i>	<i>Recorded</i>	<i>Recorded</i>	<i>Calculated</i>	<i>Eq.1</i>	<i>Measured</i>	<i>Measured</i>
SS-ID	800	7:00	6:50	1430	53.7 <sup>1</sup>	97	56
Yoke-ID	1700	10:50	8:30	1300	52.5	97	55

<sup>1</sup>See Eq.1 example below.

#### Background sample

Canister ID	Canister volume (cc)	Collection start time	Collection end time	Sampling duration (min)	Expected final vacuum (kPa)	Initial canister vacuum (kPa)	Final canister vacuum (kPa)
<i>Recorded</i>	<i>Recorded</i>	<i>Recorded</i>	<i>Recorded</i>	<i>Calculated</i>	<i>Eq.1</i>	<i>Measured</i>	<i>Measured</i>
B-SS-ID	800	7:10	7:10	1440	49.9	97	52
B-PVC-ID	1700	10:50	8:30	1300	52.5	97	55

### Laboratory sample preparation and analysis

#### Animal sample

Diluted pressure (kPa)	Dilution factor	[SF <sub>6</sub> ] of diluted animal sample (ppt)	[CH <sub>4</sub> ] of diluted animal sample (ppm)	Sampled [SF <sub>6</sub> ] (ppt)	Sampled [CH <sub>4</sub> ] (ppm)
<i>Measured</i>	<i>Eq.2</i>	<i>GC analysis</i>	<i>GC analysis</i>	<i>Eq.3</i>	<i>Eq.3</i>
30	3.2 <sup>2</sup>	34.41	18.96	110.20 <sup>3</sup>	60.72
41	3.4	77.90	17.66	263.93	59.83

<sup>2</sup>See Eq.2 example below, <sup>3</sup>See Eq.3 example below.

#### Background sample

Diluted pressure (kPa)	Dilution factor	[SF <sub>6</sub> ] of diluted background air (ppt)	[CH <sub>4</sub> ] of diluted background air (ppm)	[SF <sub>6</sub> ] of collected background air (ppt)	[CH <sub>4</sub> ] of collected background air (ppt)
<i>Measured</i>	<i>Eq.2</i>	<i>GC analysis</i>	<i>GC analysis</i>	<i>Eq.3</i>	<i>Eq.3</i>
30	3.2	4.89	2.26	15.65	7.23
41	3.4	0.97	0.67	3.31	2.29

### Calculation of daily CH<sub>4</sub> emission and CH<sub>4</sub> yield

CH <sub>4</sub> emission (g/d)	Dry Matter Intake (kg/d)	CH <sub>4</sub> yield (g/kg DMI)
<i>Eq.4</i>	<i>Measured</i>	<i>Calculated</i>
460 <sup>4</sup>	20	23.0

21.8	1.0	21.8
------	-----	------

<sup>4</sup>See Eqn 5.4 example below, after Williams et al. (2011).

### Eqn. 5.1: Calculation of the expected canister vacuum at the end of the sampling period

This equation is used to determine the expected final canister vacuum, and enables identification of blocked or leaking sampling systems, as indicated by canisters with a post-collection vacuum that differs from that expected. Inclusion of this calculation within data processing is a useful way to detect malfunctioning sampling equipment and compromised samples.

$$\text{Expected final vacuum} = \text{Initial vacuum} - \frac{\text{Inflow rate} \cdot \text{Sampling duration}}{\text{Canister volume}} \cdot \text{Initial vacuum} \frac{\text{e}}{\text{e}}$$

$$\text{E.g.: } \text{Expected final vacuum} = 97 - \frac{0.25 \cdot 1430}{800} \cdot 97 \frac{\text{e}}{\text{e}} = 53.7 \text{ kPa}$$

### Eqn. 5.2: Calculation of sample dilution

This equation is used to determine the dilution of collected gases prior to GC analysis. Dilution arises from two sources; residual gas remaining in canisters prior to sample collection (due to incomplete canister evacuation), and diluent gas added after sample collection to increase canister pressure before analysis. Some researchers add ultrapure nitrogen to canisters to pressurise the sample above atmospheric pressure, which allows passive sample flow onto the gas chromatograph. Alternatively, in a pumped system, canisters can be partially filled with nitrogen and remain partially evacuated. If the diluted canister pressure is less than atmospheric pressure (a partial vacuum), its inclusion within this calculation must be as a negative value.

$$\text{Dilution factor} = \frac{\text{Atmospheric pressure} + \text{Diluted canister pressure}}{\text{Initial vacuum} - \text{Final vacuum}}$$

$$\text{E.g.: } \text{Dilution factor} = \frac{101.3 + 30}{97 - 56} = 3.20$$

### Eqn. 5.3: Calculation of sampled gas concentration

This equation enables correction of the gas concentration – as determined by the GC – for pre-analysis sample dilution to determine the gas concentration as collected.



$$\text{Sampled gas concentration} = \text{Diluted gas concentration} \cdot \text{Dilution factor}$$

E.g.:  $\text{Sampled [SF}_6\text{]} = 34.41 \cdot 3.2 = 110.20 \text{ ppt}$

#### Eqn. 5. 4: Calculation of daily CH<sub>4</sub> emission

This equation describes the calculation of daily CH<sub>4</sub> emissions for a single animal. Gas concentrations are as sampled, following correction for pre-analysis dilution. Animal samples are corrected for background concentration after Williams et al. (2011). The SF<sub>6</sub> release rate used in this example is specified in mg/d; thus the resulting CH<sub>4</sub> emission has units of g/d.

$$\text{Methane (g/d)} = \text{SF}_6 \text{ release rate} \cdot \frac{\text{Animal sample [CH}_4\text{]} - \text{Background air [CH}_4\text{]}}{\text{Animal sample [SF}_6\text{]} - \text{Background air [SF}_6\text{]}} \cdot \frac{\text{Molecular weight CH}_4}{\text{Molecular weight SF}_6} \cdot 1000$$

E.g.:  $\text{Methane emission} = 7.4 \cdot \frac{60.72 - 7.23}{110.20 - 15.65} \cdot \frac{16.04}{146.06} \cdot 1000 = 460 \text{ g/d}$

#### Active collection

An alternative approach to collecting discrete samples and analysing them later is to take the gas chromatograph (GC) to the animals, but as the subjects are tethered to the instrument, this is only possible with a small number of animals confined in crates or stalls. So far, only one example of this approach appears in the literature (Lassey et al., 2011). The following briefly describes the configuration adopted by Lassey et al. (2011), which is based on an automated GC system – the “Lung”, developed by Martin et al. (2011) (Figure 5.19). This system enables concurrent and continuous breath sampling from three animals – in this case, sheep.

An inlet is attached to the halter beside the nose of each of three sheep in the usual way, and an airline attached to the Lung. A small pump moves sampled air from each inlet to a Tedlar bag for temporary storage (20 minute accumulation). Three bags – one per sheep – are thereby accumulating samples for 20 minutes, while three companion bags are being sequentially analysed on the GC, then evacuated during those 20 minutes. Every 20 minutes, the roles of the bags reverse, so that sample collection is continuous. These 20-minute cycles are automatically repeated and interspersed with analyses of gas standards under software control. Lassey et al. (2011) reported successive 20-minute accumulations and analyses for six days (432 accumulations and analyses per sheep). The sample frequency is dictated by the cycle time of the GC and the number of animals sampled.

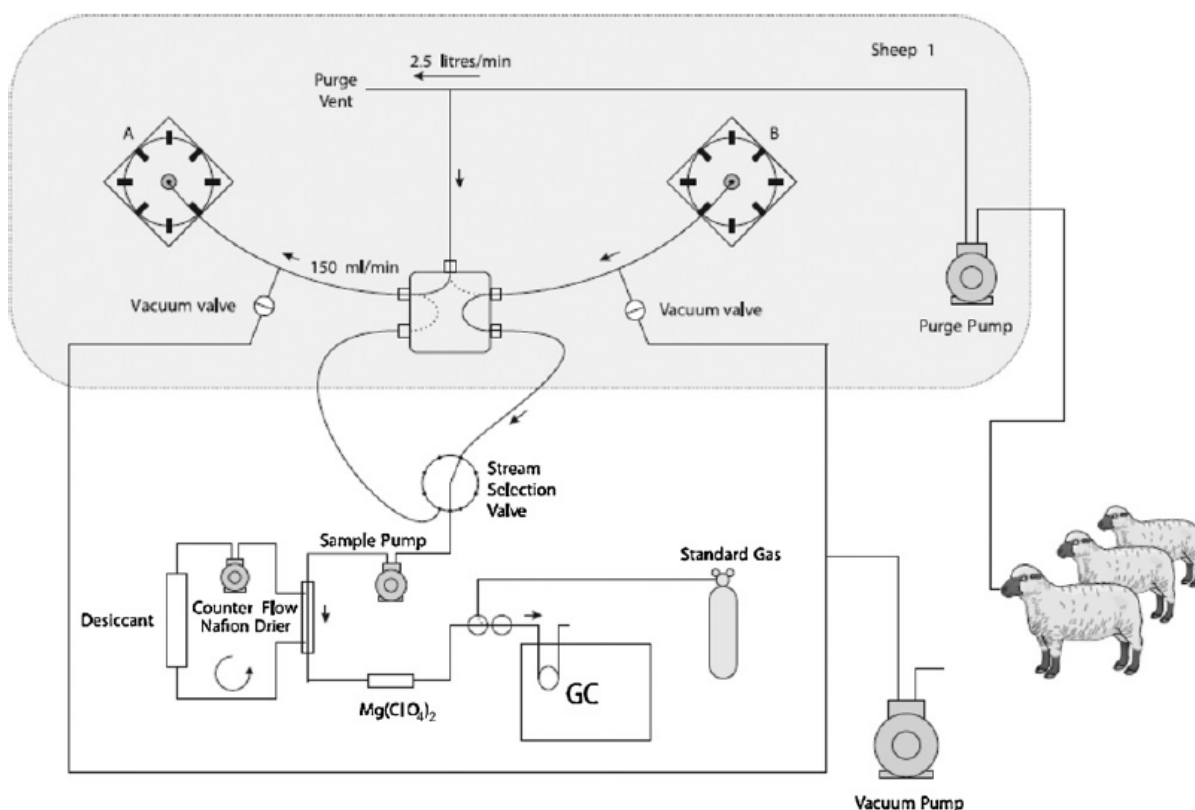

Figure 5.19: A schematic of the Lung-GC system (Martin et al., 2011), showing one of three layers of the Lung (shaded) connecting to one of three inlets represented by three sheep.

A small purge pump (one for each airline) maintains a continuous flow towards the purge vent and a smaller flow to each Tedlar bag. While Cluster A (consisting of three bags) is being filled, a sample is drawn from each bag in Cluster B, dried and directed to the GC. When all three bags in Cluster B have been analysed, they are evacuated, and the Cluster roles are reversed.

This combination of continuous collection and sequential analysis ensures that every eructation event is captured, and allows temporal patterns in both CH<sub>4</sub> and SF<sub>6</sub> to be examined. The same experiment allowed the data to be analysed in ways that mimicked different 'averaging times' – the effective sample accumulation times over which CH<sub>4</sub> emission rates were averaged – ranging from three hours to six days.

## 5.4 Conclusion

Various sampling systems are used internationally within the SF<sub>6</sub> tracer technique. These vary in the size, shape and positioning of the collection vessel, the flow restrictor used and length and configuration of the sampling apparatus between the sampling point and the collection vessel.

The most common systems use a passive, vacuum driven sampling method and a capillary tube to restrict the rate of air inflow, through a 3.17 mm tube into an evacuated PVC or stainless steel canister over a 24-hour period.

Regardless of components or design, several rules should be adhered to in order to achieve a well-functioning sampling system. The most important are:

- The rate of sample collection (flow rate; SCCM) should match the desired sampling duration (typically 24 hours) and the capacity of the evacuated sample collection vessel. Smaller collection vessels require slower air inflow rates in order to reduce the decline in sample collection rate over the sampling period. The minimum recommended post-collection canister vacuum is 50 kPa.
- The sample collection rate of assembled apparatus should be tested before each experimental use, to ensure that the actual sampling rate remains within an acceptable range. Flow restrictors are prone to blockage or calibration loss. To minimise any errors and/or data loss caused by partial or complete blockage, a particulate filter should be used, and cleaned following each use. Consideration should also be given to physical protection of the flow restrictor, as flow rate can be affected by physical manipulation of the restrictor during use. For example, bending capillary tubes alters their rate of air conductance.
- Each sample collection should begin with clean apparatus free of residual gas contamination. Consideration should be given to the random selection of a collection vessel within each set of canisters prepared for use. If filled with pure gas chromatograph carrier gas, as used for sample analysis, the concentration of both SF<sub>6</sub> and CH<sub>4</sub> should be undetectable in such a negative control.
- Pre- and post-collection vacuum of canisters should be measured using an accurate test gauge, and used to verify the sampling rate of each sampling apparatus. Pre- and post-collection vacuum should also be used to calculate the dilution factor of each sample (see Chapter 9). Vacuum measurement at canister changeover also allows for immediate correction of sampling faults (leaks or blockages) by replacement of the sample collection apparatus.
- Special care should be taken in any situation where the SF<sub>6</sub> tracer technique is used for sampling durations other than 24 hours. As a time-averaged technique reliant upon the consistent release of SF<sub>6</sub> from the reticulorumen, collecting gas samples by rapid air inflow rates for periods shorter than 24 hours is not recommended. The technique has been used for sampling durations greater than 24 hours, using very slow air inflow rates. During such experiments, care must be taken to minimise the decline in sample collection rate from the start to the end of the sample collection period. Otherwise, the relative contribution of gases sampled on the first day of a multi-day collection will be greater than those collected on the final day.

## 5.5 References

Deighton, M.H, O'Loughlin, B.M, Boland, T.M & Buckley, F, 2011. Gas sampling error in the ERUCT technique: effect of sample cross contamination. *Proceedings of the Agricultural Research Forum*, 14-15 March, Tullamore, Co. Offaly, Ireland. p62.

Deighton, M.H, O'Loughlin B.M, Williams S.R.O, Moate P.J, Kennedy E, Boland T.M & Eckard R.J, 2013. Declining sulphur hexafluoride permeability of fluoropolymer

membranes causes overestimation of calculated ruminant methane emissions using the tracer technique. *Anim. Feed Sci. Tech.* 183: 86-95.

Gere, J.I & Gratton, R, 2010. Simple low-cost flow controllers for time averaged atmospheric sampling and other applications. *Latin American Applied Research* 40: 377-381.

Hegarty, R.S, Goopy, J.P, Herd, R.M & McCorkel, B, 2007. Cattle selected for lower residual feed intake have reduced daily methane production. *J. Anim. Sci.* 85: 1479-1486.

Johnson, K, Huyler, M, Westberg, H, Lamb, B & Zimmerman, P, 1994. Measurement of methane emissions from ruminant livestock using a SF<sub>6</sub> tracer technique. *Environ. Sci. Tech.* 28: 359-362.

Johnson K.A & Johnson D.E, 1995. Methane emissions from cattle. *J. Anim. Sci.* 73: 2483-2492.

Johnson, K & Westberg, H, 2006. Methane Measurement From Ruminants: The SF<sub>6</sub> Technique. URL: <http://www.epa.gov/ruminant.html/presentation/index.htm>.

Johnson, K.A, Westberg, H.H, Michal, J.J & Cossalman, M.W, 2007. The SF<sub>6</sub> tracer technique: Methane measurement from ruminants. In: *Measuring Methane Production from Ruminants*. H.P.S. Makkar and P.E. Vercoe, ed. Springer, the Netherlands. p33-67.

Lassey, K.R, Pinares-Patiño, C.S, Martin, R.J, Molano, G, & McMillan, A.M.S, 2011. Enteric methane emission rates determined by the SF<sub>6</sub> tracer technique: Temporal patterns and averaging periods. *Anim. Feed Sci. Tech.* 166–167, 183–191.

Martin, R.J, Bromley, A.M, Harvey, M.J, Moss, R.C, Pattey, E, & Dow, D, 2011. The "Lung": a software-controlled air accumulator for quasi-continuous multi-point measurement of agricultural greenhouse gases. *Atmospheric Measurement Techniques*, 1935-1962.

Wims, C.M, Deighton, M.H, Lewis, E, O'Loughlin, B, Delaby, L, Boland, T.M & O'Donovan, M, 2010. Effect of pregrazing herbage mass on methane production, dry matter intake, and milk production of grazing dairy cows during the mid-season period. *J. Dairy Sci.* 93, 4976-4985.

Williams, S.R.O, Moate, P.J, Hannah, M.C, Ribaux, B.E, Wales, W.J & Eckard. R.J, 2011. Background matters with the SF<sub>6</sub> tracer method for estimating enteric methane emissions from dairy cows: A critical evaluation of the SF<sub>6</sub> procedure. *Anim. Feed Sci. Tech.* 170, 265-276.

## 6 SPECIAL CONSIDERATIONS FOR RUMINALLY-CANNULATED ANIMALS

T. Boland<sup>a\*</sup>, G.C. Waghorn<sup>b</sup>, P.J. Moate<sup>c</sup>, A.D. Iwaasa<sup>d</sup>, A. Berndt<sup>e</sup> & C. Martin<sup>fg</sup>

<sup>a</sup>School Of Agriculture & Food Science, Agriculture and Food Science Centre, University College Dublin, Belfield, Dublin, Ireland

<sup>b</sup>DairyNZ, Hamilton, New Zealand

<sup>c</sup>Department of Environment and Primary Industries (DEPI), Ellinbank, Victoria, Australia

<sup>d</sup>Agriculture and Agri-Food Canada/Agriculture et Agroalimentaire Canada - Semiarid Prairie Agricultural Research Centre, Saskatchewan, Canada

<sup>e</sup>Embrapa, Fazenda Canchim, São Carlos, SP - Brasil

<sup>f</sup>INRA, UMR1213 Herbivores, Saint-Genès-Champanelle, France;

<sup>g</sup>Clermont Université, VetAgro Sup, UMR1213 Herbivores, Clermont-Ferrand, France

\*Corresponding Author: T. Boland [tommy.boland@ucd.ie](mailto:tommy.boland@ucd.ie)

---

### 6.1 Advantages of the SF<sub>6</sub> tracer technique

The use of the SF<sub>6</sub> tracer technique on ruminally-cannulated animals allows for frequent, detailed sampling of rumen contents in order to study the rumen microbial metabolism, as well as estimating enteric methane (CH<sub>4</sub>) emissions.

In the absence of ruminally-cannulated animals, rumen fluid may be obtained by oesophageal sampling or rumenocentesis. However, there are concerns around the accuracy of single time-point sampling techniques. In a comparison between oesophageal and per cannula sampling, Rowntree et al. (2010) reported that volatile fatty acids (VFA) profiles did not differ between sampling techniques, when the samples were collected from a single site within the rumen. Samples collected by oesophageal sampling had significantly lower total VFA concentrations, suggesting saliva contamination of between 10 and 30% in rumen fluid samples collected from sheep using that method (Waghorn, unpublished data), and a 10% reduction in rumen ammonia concentrations. Another issue with oesophageal sampling is the uncertainty of the precise sampling location in intact animals.

An additional benefit from using the SF<sub>6</sub> tracer technique on ruminally-cannulated animals is that it allows permeation tubes to be retrieved at the end of a study, and

release rates to be recalculated. Alternatively, permeation tubes can be replaced for longer duration studies.

A number of studies have measured CH<sub>4</sub> from intact and rumen-fistulated animals using the SF<sub>6</sub> tracer technique, and most measurements have been consistent (e.g., Morgavi et al., 2008, 2012; Pinares-Patiño et al., 2008; Chung et al., 2010, 2011).

This is not surprising if the proportions of SF<sub>6</sub> and CH<sub>4</sub> gases lost through the fistulae are similar to those eructated. The extent of fermentation gas loss from the fistulae is likely to be affected by rumen fill, and a full rumen is likely to provide some degree of sealing by holding the inner cannula against the rumen wall. In other words, gas leakage from the rumen, and air into it, may be greater in a partially empty animal than a full one. Waghorn (unpublished) suggested that 60 to 70% of rumen CH<sub>4</sub> was lost via the fistulae of lactating dairy cows grazing pasture, when measured using the GreenFeed system (C-lock Inc.)

## 6.2 Limitations and concerns

Anecdotes abound of implausible CH<sub>4</sub> estimates obtained by using the SF<sub>6</sub> tracer technique in ruminally-cannulated animals, but there is little documented evidence for this. One possible explanation is that disparate leakage of SF<sub>6</sub> and CH<sub>4</sub> through the cannula might cause inaccurate estimation of CH<sub>4</sub> emissions, but we know of no evidence for this. Another possibility that could be investigated is that the cannulae may absorb SF<sub>6</sub>, causing a lower concentration of this gas in the breath sample, and consequently an overestimation of CH<sub>4</sub> emission. Again however, this is not supported by evidence, and the use of the SF<sub>6</sub> tracer technique in ruminally-cannulated animals has been widely reported, despite these concerns (e.g., Morgavi et al., 2008, 2012; Pinares-Patiño et al., 2008; Chung et al., 2010, 2011).

A recent report by Beauchemin et al. (2012) attempted to measure the impact of fistulation on CH<sub>4</sub> and SF<sub>6</sub> leakage from the fistulae, but the placement of sampling ports may have influenced the findings. Nevertheless, there is no doubt that gases do leak around the cannulae. The authors concluded that cannulae configuration can affect the extent of this leakage and that the use of the SF<sub>6</sub> tracer technique in ruminally-cannulated animals is not recommended.

Some authors have used ruminally-cannulated animals (for estimation of rumen fermentation variables) in conjunction with intact animals (SF<sub>6</sub> estimation of CH<sub>4</sub> emissions (Foley et al., 2008; 2009; Hulshof et al, 2012)), with the obvious limitations that measurements are collected on different groups of animals. Moate et al. (2103) reported modest, though non-significant decreases of daily CH<sub>4</sub> emissions and a significant reduction in CH<sub>4</sub> yield for ruminally-cannulated animals in respiration chambers. Furthermore, these authors reported that cannulae allowed significant air ingress into the rumen headspace. This represents evidence of a direct effect of rumen cannulation on at least one aspect of rumen fermentation. Researchers should therefore be cautious when prescribing effects observed in ruminally-cannulated animals to intact animals. Further study is merited.



### 6.3 Rumen headspace gas sampling

The utilisation of the rumen headspace gas sampling technique on fistulated animals, in association with the use of SF<sub>6</sub> as a tracer gas, is an opportunity to study the kinetics of ruminal gas production. Jouany and Senaud (1979) used cannulae equipped with a valve (see Figure 6.1) to collect rumen gas headspace samples without having to open the cannula. To avoid contamination with ruminal fluid, a needle is inserted through the cannulae bung to sample the dorsal sac from standing animals.

Martin et al. (2012) have used this methodology on dry cows, and the SF<sub>6</sub> tracer technique for different release rates of SF<sub>6</sub> in the rumen, as shown in Figure 6.2. The results on the kinetics of gas production in the rumen agree with those reported in literature, supporting this approach. Alternatively, Moate et al. (1997) described the sampling of rumen headspace gas by rumenocentesis by inserting a needle via the para-lumbar fossa, through the skin, musculature and rumen wall, directly into the rumen headspace, from where gas is collected into a gas-tight syringe. They also collected rumen headspace gas from rumen fistulated cows by simply inserting a needle through the bung of a rubber rumen cannula ([www.rumencannula.com](http://www.rumencannula.com)). Hristov et al. (2007) has used samples of rumen headspace gas and the SF<sub>6</sub> tracer technique to obtain estimates of CH<sub>4</sub> emissions in lactating cows.

Martin et al. (2012) also compared CH<sub>4</sub> emissions estimates from gas samples of ruminal headspace and breath using the SF<sub>6</sub> tracer in dry cows. The breath samples yielded systematic 8 to 9% higher CH<sub>4</sub> emissions estimates than the ruminal samples, suggesting that the breath sources accounted for the hindgut production of CH<sub>4</sub> which is mostly exhaled.

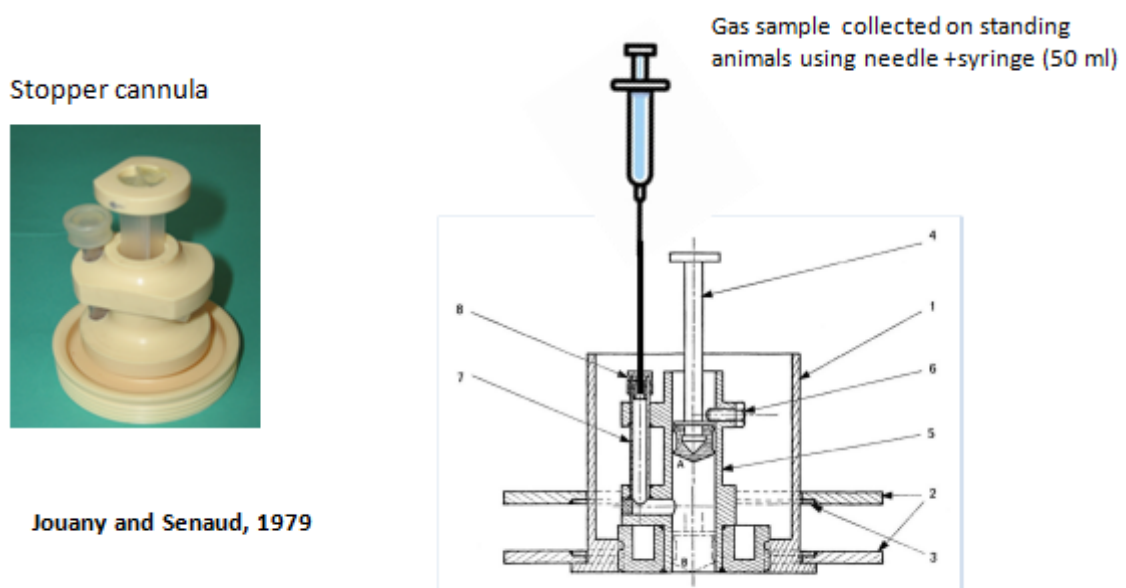

Figure 6.1: Apparatus for rumen headspace gas sampling (Jouany and Senaud, 1979).



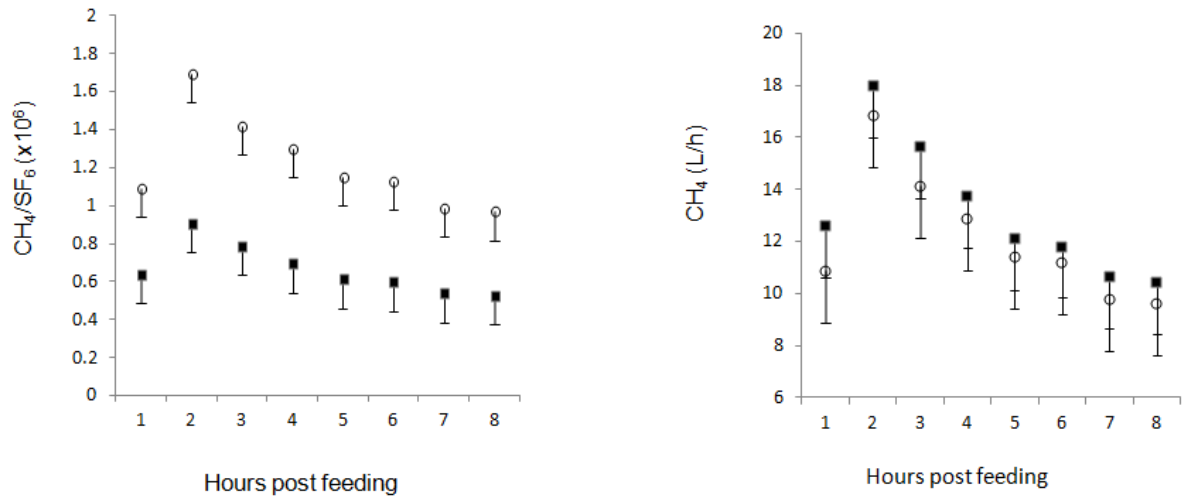

Figure 6.2: Post feeding kinetics of gas concentration ratios and estimated hourly productions of CH<sub>4</sub> and CO<sub>2</sub>, based on gases sampled from the rumen headspace with low (LRR, ○) and high (HRR, ■) release rates of SF<sub>6</sub>.

Bars represent mean SED of all data points within the same graph. (Reproduced from Martin et al., 2012)

The use of ruminally-cannulated animals to evaluate ruminal fermentation parameters is open to question. A particular issue is the possibility of gas exchange and loss of anaerobiosis. There are also growing animal welfare concerns around using fistulated animals, which may restrict their future use. However, there is no other way to efficiently monitor the rumen microbial metabolism – other than through cannulated animals – hence their widespread use. There is evidence to show leakage of gases both out of and into the rumen via the fistulae, and limited evidence that the fistulae has significant detrimental effects upon CH<sub>4</sub> yield and CH<sub>4</sub> estimation using the SF<sub>6</sub> tracer technique. Researchers must follow good scientific protocols to minimise possible experimental errors.

- Using ruminally-cannulated animals to assess various aspects of rumen fermentation and microbiome is highly attractive.
- Issues exist around air ingress and release through the cannula.
- Caution is required when prescribing effects observed in cannulated animals to intact animals.

## 6.4 References

Beauchemin, K.A, Coates, T, Farr, B & McGinn, S.M, 2012. Technical note: Can the sulphur hexafluoride tracer gas technique be used to accurately measure enteric methane production from ruminally-cannulated cattle. *J. Anim. Sci.* (published online March 9, 2012).

Chung, Y-H, He, M.L, McGinn, S.M, McAllister, T.A & Beauchemin, K.A. 2011. Linseed suppresses enteric methane emissions from cattle fed barley silage, but not from those fed grass hay. *Anim. Feed Sci. Tech.* 166-167:321– 329.

Chung, Y-H, Walker, N.D, McGinn, S.M & Beauchemin, K.A, 2011. Differing effects of 2 active dried yeast (*Saccharomyces cerevisiae*) strains on ruminal acidosis and methane production in nonlactating dairy cows. *J. Dairy Sci.*. 94:2431–2439.

Foley, P.A, Kenny, D.A, Callan, J.J, Boland, T.M & O'Mara, F.P, 2009. Effect of dietary level of malic acid on intake, rumen methanogenesis and rumen fermentation in beef cattle. *J. Anim. Sci.*, 87: 1048-1057.

Foley, P.A, Kenny, D.A, Lovett, D.K, Callan, J.J, Boland, T.M & O'Mara, F.P, 2009. Effect of DL-malic acid supplementation on feed intake, methane emissions and performance of lactating dairy cow at pasture. *J. Dairy Sci.* 92(7): 3258-3264.

Hristov, A.N, Van der Pol, M, Agle, M, Zaman, S, Schneider, C, Ndegwa, P, Vadella, V.K, Johnson, K, Shingfield, K.J & Karnati, S.K.R, 2009. Effect of lauric acid and coconut oil on ruminal fermentation, digestion, ammonia losses from manure, and milk fatty acid composition in lactating cows. *J. Dairy Sci.* 92: 5561–5582.

Hulshof, R, Berndt, A, Gerrits, W.J.J, Dijkstra, J, Van Zijderveld, S.M, Newbold, J.R & Perdok, H.B. 2012. Dietary nitrate supplementation reduces methane emission in beef cattle fed sugarcane-based diets. *J. Animal Sci.*, 90: 2317-2323.

Jouany, J.P & Senaud, J, 1979. Description d'une technique permettant d'effectuer des prélèvements répétés de gaz dans le rumen. *Annales Biologie Animale Biochimie Biophysique* 19, 1007-1010.

Martin, C, Koolards, J, Rochette, Y, Clark, H, Jounay, J.P & Pinares-Patiño, C.S, 2012. Effect of release rate of the SF<sub>6</sub> tracer on methane emission estimates based on ruminal and breath gas samples. *Animal* 6:3, 518–525.

Moate, P.J, Clarke, T, Davis, L.H & Laby, R.H, 1997. Rumen gases and bloat in grazing dairy cows. *J. Agric. Sci.* 129: 459-69.

Moate, P.J, Williams, S.R.O, Deighton, M.H, Jacobs, J.L & Wales, W.J (2013). Influence of rumen cannulation on feed intake, milk production, enteric methane production and composition of rumen headspace gas. *Advances in Animal Biosciences* 4, 423.

Morgavi, D.P, Jounay, J.P & Martin, C. 2008. Changes in methane emission and rumen fermentation parameters induced by refaunation in sheep. *Aust. J. Exp. Agric.* 48, 69–72.

Morgavi D.P, Martin, C, Jouany, J.P & Ranilla, M.J, 2012. Rumen protozoa and methanogenesis: not a simple cause-effect relationship. *British J. Nutrition*, 107, 388–397.

Pinares-Patiño, C.S, Machmüller, A, Molano, G, Smith, A, Vlaming, J.B & Clark, H, 2008. The SF<sub>6</sub> tracer technique for measurements of methane emission from cattle – effect of tracer permeation rate. *Can. J. Anim. Sci.* 88; 309–320.

Rowntree, J.D, Pierce, K.M, Kenny, D.A, Kelly, A.K & Boland, T.M, 2010. A comparison of rumen fluid sampling techniques for ammonia and volatile fatty acid determination. In Proceedings of the 61st meeting of the European Association of Animal Production, Heraklion, Crete, 23-27 August, 2010; p76.

## 7 SAMPLING BACKGROUND AIR

S.R.O. Williams<sup>a\*</sup>, P.J. Moate<sup>a</sup> & M.H. Deighton<sup>a</sup>

<sup>a</sup>Department of Environment and Primary Industries (DEPI), Ellinbank, Victoria, Australia

\*Corresponding Author: S.R.O. Williams; richard.williams@depi.vic.gov.au

---

The concentrations of methane (CH<sub>4</sub>) and sulphur hexafluoride (SF<sub>6</sub>) in the air surrounding an animal are derived from three main sources: trace quantities in the earth's atmosphere; emissions from nearby animals, and the animal's own breath. For the purposes of a SF<sub>6</sub> tracer technique, 'background air' can be defined as the concentration of CH<sub>4</sub> and SF<sub>6</sub> within an animal breath sample that has a source other than the animal being sampled. While an animal may also inhale some of its previously exhaled breath, this has been shown to be immaterial in principle (Lassey, 2013).

Sampling background air requires careful consideration. The aim is to collect air representative of the background air, over the same period that breath samples are collected. This might involve collecting air samples for each individual animal, or for a group of animals.

This chapter discusses the considerations associated with sampling equipment, its location, and some consequences of different choices.

### 7.1 Apparatus

The essential elements of a background-air sampling system are the same as those used to collect breath samples (Chapter 5). Many researchers have reported using apparatus similar to that used to collect breath samples from animals, but this need not be the case. Figure 7.1 shows an example of equipment for collecting background samples. This equipment works equally well indoors or outdoors, where it can be easily hung on a fence.

Note the tag with the number 1.5 written on it: this indicates the flow rate (1.5 ml/min at 95 kPa vacuum) of the restricting capillary tube. Labelling the sample tubes is particularly useful if different air sampling rates are being used to collect background samples for different durations. For example, if background air is sampled indoors while animals are feeding (e.g., seven hours duration) and different background samples are collected while the animals are loafing outside (e.g., 17 hours duration) then different gas sampling rates are required for the indoor and outdoor sampling so the vacuum remaining at the end of sampling – and sample quantity – is similar for all samples.

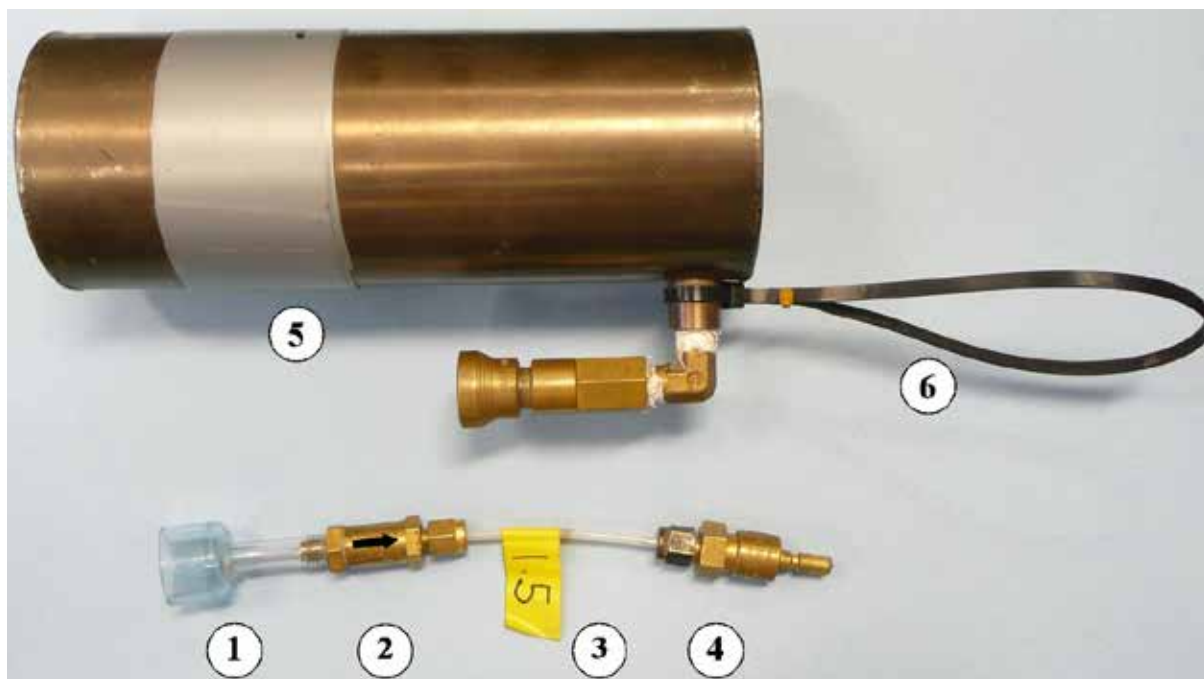

Figure 7.1: Example equipment used to collect samples of background air at the Department of Environment and Primary Industries, Victoria, Australia.

1. Flared snorkel: reduces the chance of moisture being sucked into the tube – especially useful if it is raining. The snorkel is fabricated from clear tube and an old filter body.
2. Filter: 15 micron (Swagelok B-2F-15). Note direction arrow.
3. Nylon tubing 1/8" OD by 50 mm long, with crimped capillary fitted in QC4 connector.
4. Quick Connect stem (Swagelok B-QC4-S-200), to suit connector on sample collection canister. 5. Sample collection canister with Quick Connect body (Swagelok B-QC4-B-2PF).
6. Insulating handle (conveniently sized cable tie) - necessary if metal canisters are to be hung on an electric fence wire.

## 7.2 Outdoors

When animals are grazing, it may be impossible to sample the background air for a particular animal, so it is necessary to estimate the concentrations of background gases. Consider the arrangement of animals shown in Figure 7.2, and suppose the wind is blowing from left to right. Animal A will be standing in fresh air, uncontaminated by the exhaled breath of cohorts, while animal B will be standing in a mixture of fresh air and the exhalations of the animals upwind. Air collected at sampling point 4 is likely to be representative of the air inhaled by animal A, while air collected at sampling point 2 is likely to be the most representative of air inhaled by animal B.

Since the animals are free to move about, and the wind can change direction, we recommend the use of at least four sampling points to collect background air, which are averaged to represent the best estimate of the background gases entrained within the sample from each individual animal. An alternative approach, trialled in New

Zealand, is to put background air sampling equipment on the backs of some of the animals in the group (Cesar Pinares-Patiño, AgResearch, Palmerston North, New Zealand). The objective is to sample air representative of that surrounding the animal throughout the sampling period, without bias due to changes in wind direction and animal location.

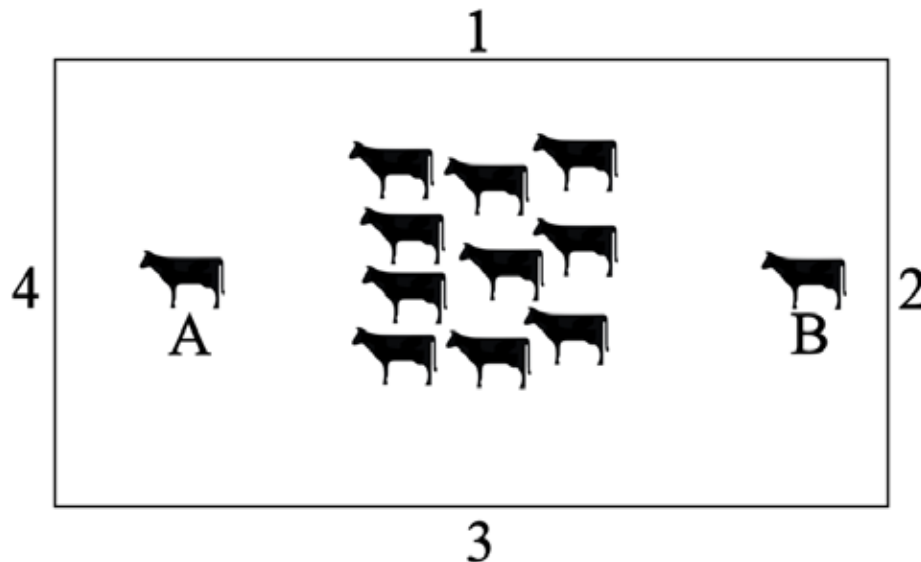

**Figure 7.2: A theoretical arrangement of animals in an outdoor area and potential fixed sites for sampling background air (numbered).**

The effect of height above the ground on the concentrations of CH<sub>4</sub> and SF<sub>6</sub> in the sample collected is generally negligible. Williams et al. (2011) sampled background air outdoors at four different heights, and found no significant difference in the concentrations of either CH<sub>4</sub> or SF<sub>6</sub>. Given this, the sampling devices can be hung on the top wire of a fence surrounding the paddock for convenience of distribution and retrieval (Figure 7.3). An alternative is to mount the sampling equipment on a temporary post outside the grazing area to avoid damage or sample contamination by curious animals.

Equipment used to collect samples of background air is exposed to the elements, so some protective measures may be necessary. In particular, rain or other moisture should be prevented from entering the sampling tube where it can block the flow restrictor. Using a flared snorkel, such as that shown in Figure 7.1, reduces the risk of moisture being drawn into the sampling tube.





Figure 7.3: Equipment for sampling the background air can be hung on a fence.

### 7.3 Indoors

The task of sampling background air can become more complicated when animals are housed indoors. The physical design of the housing may lead to differential accumulations of both CH<sub>4</sub> and SF<sub>6</sub> within the building, and the concentration of those gases within the building will almost certainly be higher than outside. Gas concentrations vary with location in three dimensions (Williams et al., 2011). Enclosed buildings are unlikely to be suitable for use with a SF<sub>6</sub> tracer technique. Buildings with low air volume per animal, low air turnover rates, or poor ventilation at animal level – as can be induced by pens with solid walls – may have elevated concentrations of CH<sub>4</sub> or SF<sub>6</sub> in background air. These may be so elevated that they are a significant proportion of animal breath samples, which is contrary to the requirements of the tracer technique (see Chapter 11).

The challenge for sampling indoors is to identify sentinel locations that will enable the reliable estimation of background concentrations of both CH<sub>4</sub> and SF<sub>6</sub>. Each building design, and stocking density, will have different air flow characteristics. This means the sentinel locations may be different for each building and each arrangement of animals. The only way to identify suitable sentinel locations is to initially collect samples from more locations than will be eventually used (Figure 7.4), so as to create a three



dimensional map of gas concentration. Then the most representative locations for sampling background air can be chosen.

For group-housed animals, it may not be possible to estimate a background for each individual. For one large group, the situation is similar to animals outdoors, and a set of sampling points around the outside of the pen may be the only option. Housing small groups of animals within a series of pens allows for background sampling of each pen, and using that background for each animal within that pen.

For individually stalled animals, it is possible to estimate the background for each animal. The arrangement of sentinel locations will depend on the arrangement of stalls. Williams et al. (2011) investigated the distribution of CH<sub>4</sub> and SF<sub>6</sub> in background air within an open-sided building with cows housed individually in a single row of stalls. They found that concentration of both CH<sub>4</sub> and SF<sub>6</sub> varied quadratically along the length of the building (Figure 7.5).



Figure 7.4: Sampling the background air at many locations is necessary to determine the most representative.

---

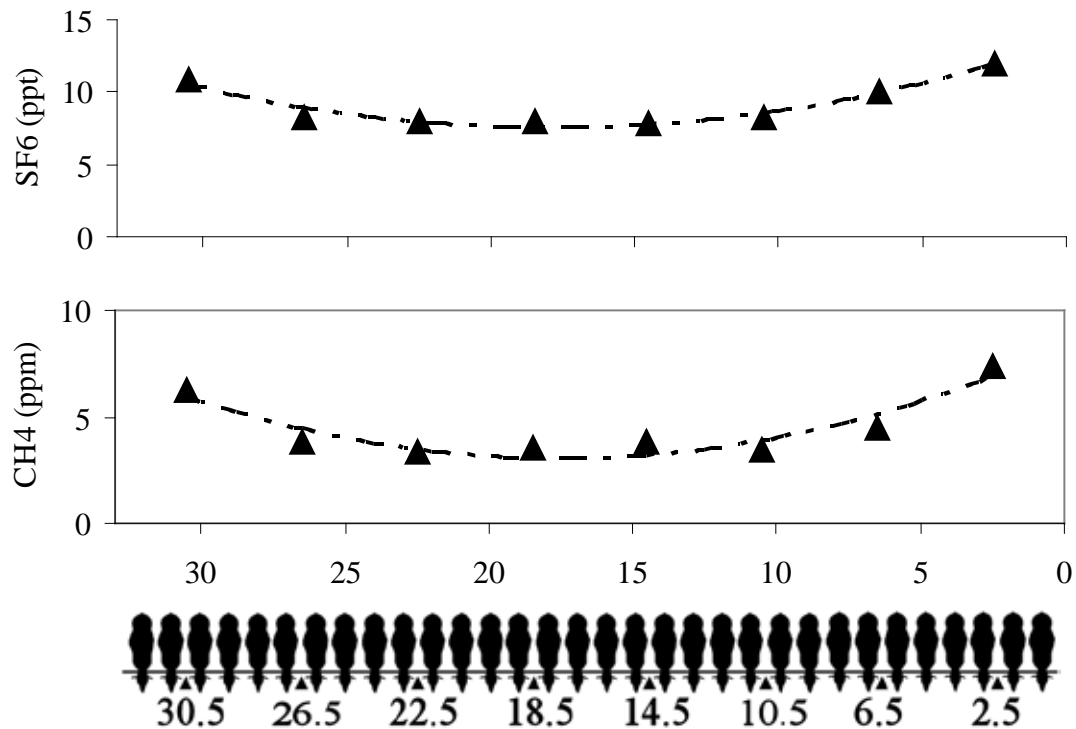

Figure 7.5: Example concentrations of CH<sub>4</sub> and SF<sub>6</sub> with cow position along a single row of stalls and sentinel positions for sampling of background air at Department of Environment and Primary Industries, Victoria, Australia.

Williams et al. (2011) also found that the concentration of both CH<sub>4</sub> and SF<sub>6</sub> varied significantly ( $P < 0.05$ ) between floor level and the most elevated location. So which sampling height is the most appropriate? The sample should reflect the background air being experienced by the animals. Williams et al. (2011) concluded that the air at, or near, the same level as the top of their solid-sided feed box was most appropriate for sampling background air.

For the animal housing described by Williams et al. (2011), the background concentration of gases for a particular position ( $i$ ) can be calculated from the quadratic model for each gas (Eqn 7.1).

$$BG_i = A' (Position_i)^2 + B' (Position_i) + C \quad \text{Eqn 7.1}$$

Where:

- $BG_i$  is the predicted concentration of background gas at position ( $i$ )
- $A$ ,  $B$  and  $C$  are constants for the gas (CH<sub>4</sub> or SF<sub>6</sub>) concentration being calculated. They are derived from fitting a quadratic model to the concentration of gas at the sentinel locations.

- Position ( $i$ ) is the  $i^{\text{th}}$  animal stall along the length of the animal house.

It is important to note that different configurations of animals and buildings may require different models to predict the background gas concentrations for a given location. The general principle, however, should still apply.

An alternative to using lots of sampling equipment to monitor indoor backgrounds is to keep the concentrations of gases in background air much lower than that in breath samples, which lessens the impact of small errors in estimating CH<sub>4</sub> emissions (Lassey, 2013). This could be achieved by increasing the ventilation rate when mechanical ventilation is available, or by decreasing the density of the animals within the building.

Calculating CH<sub>4</sub> emissions from animals with individual backgrounds is the same as that for a shared background (Chapter 11).

## 7.4 Mixed accommodation

In experiments where feed intake is measured, animals may be individually fed at one location and rest at another (Moate et al., 2011; Pinares-Patiño et al., 2008). Feed stalls are commonly indoors, or at least under a roof, which is expected to result in concentrations of gases in background air to be elevated above outdoor concentrations. Conversely, resting areas are typically outdoors, where background concentrations of gases are at their minimum. Maximising the time animals spend in the resting area is one way of minimising the effect that background gases can have on the estimation of CH<sub>4</sub> emissions, but this must not be at the expense of the time required by animals for eating.

When animals spend part of each breath-collection period indoors and the rest outdoors, it is necessary to sample background air in some way that mimics the background air being experienced by the animals over the breath-collection period. Some researchers have moved their background sampling apparatus with the animals, but this has the effect of creating an average sample during the collection. Unless animals are penned as one single group, both indoors and outdoors, this process can limit the usefulness of the sample collected.

Using separate apparatus for sampling background air indoors and outdoors, and activating each set only while the animals are at that location enables the estimation of time-weighted averages of the concentrations of background gases entrained within the animal samples. Sentinel locations can be used indoors to predict the backgrounds for individuals (or small groups) while animals are housed (Section 7.3). A set of locations can be used outdoors to estimate the average background experienced while animals are loafing (Section 7.2). Pooling the two is achieved by weighting the predicted indoor and estimated outdoor background, according to the duration the animals spent in each environment (Eqn 7.2). The pooled background concentrations of CH<sub>4</sub> and SF<sub>6</sub> for an animal are then used in the calculation of CH<sub>4</sub> emissions for that animal.

$$BG_{av} = BG_i \cdot \frac{t_h}{t_h + t_o} + BG_o \cdot \frac{t_o}{t_h + t_o} \quad \text{Eqn 7.2}$$

Where:

- BG<sub>av</sub> = time weighted average concentration of background gas for an animal, or group of animals
- BG<sub>i</sub> = predicted concentration of background gas for an animal at the *i*<sup>th</sup> position in the animal house.
- t<sub>h</sub> = duration animals housed indoors
- t<sub>o</sub> = duration animals spent outdoors
- BG<sub>o</sub> = average concentration of background gas for an animal, or group of animals, while housed outdoors.

## 7.5 Conclusion

There is no single 'correct' way to collect samples of background air. Researchers should choose a strategy which enables the collection of samples that best represent the background air experienced by the animals under their experimental conditions.

## 7.6 References

- Lassey, K.R, 2013. On the importance of background sampling in applications of the SF<sub>6</sub> tracer technique to determine ruminant methane emissions. *Anim. Feed Sci. Tech.* 180, 115–120.
- Moate, P.J, Williams, S.R.O, Grainger, C, Hannah, M.C, Ponnampalam, E.N & Eckard, R.J, 2011. Influence of cold-pressed canola, brewers grains and hominy meal as dietary supplements suitable for reducing enteric methane emissions from lactating dairy cows. *Anim. Feed Sci. Tech.* 166-167, 254-264.
- Pinares-Patiño, C.S, Machmüller, A, Molano, G, Smith, A, Vlaming, J.B & Clark, H, 2008. The SF<sub>6</sub> tracer technique for measurements of methane emission from cattle - effect of tracer permeation rate. *Can. J. Anim. Science* 88, 309-320.
- Williams, S.R.O, Moate, P.J, Hannah, M.C, Ribaux, B.E, Wales, W.J & Eckard, R.J, 2011. Background matters with the SF<sub>6</sub> tracer method for estimating enteric methane emissions from dairy cows: A critical evaluation of the SF<sub>6</sub> procedure. *Anim. Feed Sci. Tech.* 170, 265–276.

## 8 ANALYSES OF BREATH SAMPLES

K.R Lassey<sup>a\*</sup>, R.J Martin<sup>b</sup>, S.R.O Williams<sup>c</sup>, A Berndt<sup>d</sup>, A.D Iwaasa<sup>e</sup>, R.S Hegarty<sup>f</sup>, P.J Moate<sup>c</sup>, M.H Deighton<sup>c</sup>, & B.E Ribaux<sup>c</sup>

<sup>a</sup> Lassey Research & Education Ltd Lower Hutt, New Zealand

<sup>b</sup> National Institute of Water and Atmospheric Research, Wellington, New Zealand

<sup>c</sup> Department of Environment and Primary Industries, Ellinbank, Victoria, Australia

<sup>d</sup> Embrapa, Fazenda Canchim, São Carlos, SP - Brasil

<sup>e</sup> Agriculture and Agri-Food Canada/Agriculture et Agroalimentaire Canada - Semiarid Prairie Agricultural Research Centre, Saskatchewan, Canada

<sup>f</sup> School of Environmental and Rural Science, University of New England, Armidale NSW, Australia

\*Corresponding Author: K.R Lassey keith@lasseyresearch.co.nz

---

This chapter describes how to extract sub-samples of each breath or background sample from a collection canister or otherwise deliver for analysis, and how to analyse it for SF<sub>6</sub> and CH<sub>4</sub> – usually by gas chromatography (GC).

### 8.1 Sample extraction

After gas samples have been collected (Chapter 5), one or more sub-samples need to be extracted for analysis to determine mixing ratios of methane (CH<sub>4</sub>) and SF<sub>6</sub>.

Sub-sampling is done in one of five ways: (1) over-pressurising each collection canister by diluting with high-purity nitrogen, so that successive sub-samples can be pushed out by the pressure; (2) extracting one or more sub-samples from the collection canister into vials at the experimental site for later analysis; (3) using an extraction system, based on a vacuum pump, to suck samples from the canister and transfer them directly to the GC; (4) diluting with high purity nitrogen to a small vacuum, and drawing a sub-sample into the sampling loop of the GC using a pump at its outlet; and (5) actively pumping samples from the inlet near the animal's nose, or at the background site – avoiding use of a pre-evacuated canister altogether – then transferring them to the GC.

### ***Over-pressurising with nitrogen***

This is the standard approach recommended by Johnson et al. (1994, 2007), chosen for expediency rather than analytical precision. The collection canister, with ~50 kPa (half ambient) pressure, is over-pressurised with high-purity nitrogen – typically to 20–50 kPa over-pressure – which dilutes the sample about 2.5-fold. The over-pressure is then used to drive successive (usually up to three) small sub-samples into the GC analyser for replicate analyses. This approach avoids having to extract a sample from sub-ambient pressure. However, by diluting the sample to about 40% of its original concentration, it also weakens the GC signal, reducing accuracy in inferred mixing ratios.

A collected sample pressure of ~50 kPa strikes a compromise: it is large enough to minimise the dilution necessary to achieve ~130 kPa absolute pressure, but small enough to ensure the growing back-pressure does not excessively slow down the rate of sample collection, noting that a sample should ideally be collected at a uniform rate.

### ***Sub-sampling into vials***

Sub-sampling into one or more vials has many virtues, but one major drawback. It is particularly appropriate when samples must be shipped from the experimental site to a distant analytical laboratory. It also enables fast canister turnover if they are in short supply, and/or unwieldy to transport to a laboratory. However, careful quality control is essential to avoid sample contamination and cross-contamination due to leaky vials. Methods of sub-sampling for such interim storage – which may still involve over-pressurising with nitrogen – are addressed in Section 8.4.

### ***Sample extraction system***

This system was developed at NIWA, New Zealand (G.W. Brailsford, R.J. Martin, K.R. Lassey, unpublished). The NIWA ‘piston extractor’ uses a double-ended piston and vacuum pump to extract a sub-sample from the canister, compress it, then push it into the GC sample loop, from which it first purges the preceding sample. One piston chamber is accessed by the vacuum pump and the other by the sub-sample. The compressed sub-sample is sufficient for three sequential replicate analyses. Because this approach does not require initial overpressure, it avoids diluting the sample and weakening the signal at the GC detectors.

This offers three benefits. First; the undiminished GC signal allows for more precise mixing ratio estimates, particularly at low SF<sub>6</sub> mixing ratios (Section 8.2). Second; the sample size is determined only by the needs of gas analysis. This means a slower sample collection rate can be used, and a declining collection rate due to back-pressure becomes less of a concern. Third; yoke re-evacuation is quicker, unless flushing is required. Flushing need not be required if the evacuating pump can evacuate the canisters to an absolute pressure below ~0.1kPa, which at NIWA is achieved using a Hivac pump model TRP-12 ([www.hivac.co.nz](http://www.hivac.co.nz)), which has a pumping speed of 170 L/min, and is capable of evacuating to below 10<sup>-4</sup> kPa absolute pressure.

The NIWA piston extractor is manually operated (though it can be automated) through a sequence of switches which activate pneumatic valves. It requires a DC power supply, a compressed air supply (of any quality) and a dedicated vacuum pump to drive the piston.

All New Zealand field work since ca 2001 has used the NIWA piston extractor, in preference to canister over-pressuring. The extractor is also well suited to sub-sampling into vials (Section 8.4).

A procedure developed independently at Armidale, NSW, Australia by Hegarty and co-workers transferred samples from a PVC yoke to Tedlar bags, using an oil-free piston pump (Welch Thomas; Model 2581C-02, Skokie, USA). The sample inlet of the pump is initially occluded by a male quick-connect (Swagelok). The pump then evacuates its interior and a closed 5L Tedlar bag is connected to the pump outlet. The pump is switched off, and the yoke containing the sample is attached to the pump via its fitted female quick-connect. The pump is then turned on again and the Tedlar bag opened, so that the sample is transferred through the pump into the Tedlar bag, whereupon the Tedlar bag is closed and removed.

Samples of gas are subsequently withdrawn from the Tedlar bag for SF<sub>6</sub> and CH<sub>4</sub> analysis. Tests using a mixed gas standard (initial mixing ratio CH<sub>4</sub>:SF<sub>6</sub> = 206:1 vol/vol) indicated a ratio indistinguishable from samples released by over-pressurising the yoke (207:1) or by extraction from the yoke by a mild vacuum (207:1) or by a strong vacuum (208:1), as described by Hegarty et al. (2007). While such direct transfer has proved adequate for samples with high SF<sub>6</sub> concentrations (1–30 ppb, or 1000–30,000 ppt), no data are available for this extraction approach when SF<sub>6</sub> concentrations are in the low to mid ppt range, where contamination of samples through the pump may need extra attention.

### ***Over-pressurising plus pumping***

This is a hybrid approach, involving a lesser dilution with pure nitrogen to typically 10 kPa vacuum, nearly halving original concentrations. With this reduced vacuum, samples can be readily pumped directly into the GC sample loop by means of a pump on the exhaust of that loop. This procedure was developed at DPI, Ellinbank, Victoria, Australia.

### ***Active sample pumping***

Rather than collect samples by drawing passively into a pre-evacuated canister, air can be pumped directly from the inlet at the animal's nose into a temporary accumulator before sub-sampling for GC input. Typically, the sample would be pumped at a uniform rate into a Tedlar bag from an inlet near the nostrils of each penned animal. This approach was adopted by Lassey et al. (2011) using a NIWA-designed 'Lung' (Martin et al, 2011) in an adjacent portable laboratory. Operating unattended under software control, the Lung gathers samples, analyses them, then discards the residues to ready the bags for reuse, through successive cycles of as short as 20 minutes with full sampling continuity. Further detail is supplied in Chapter 5.



While more expensive than conventional passive sampling, the NIWA Lung can run with only occasional oversight for several days, enabling Lassey et al. (2011) to investigate detailed CH<sub>4</sub> and SF<sub>6</sub> emission patterns throughout successive feeding cycles.

## 8.2 Analysis by gas chromatography

### *GC configurations*

Almost all practitioners have followed Johnson et al. (1994) in using GC for gas analysis. Indeed, SF<sub>6</sub> is popular as a tracer because of its quantitative detection at very low levels (ppt: pmol(SF<sub>6</sub>)/mol(dry air)) by GC with electron capture detection (GC/ECD). See Chapter 2. Methane is readily detectable at levels of 10<sup>-3</sup> ppm [ppm: μmol(CH<sub>4</sub>)/mol(dry air)], or higher by GC with flame ionisation detection (GC/FID).

This section is not a definitive manual on gas chromatography. It is recommended that every research team using the SF<sub>6</sub> tracer technique include a researcher experienced in gas chromatography and gas handling.

All GC analyses should be conducted in a temperature-controlled laboratory to minimise any drift in GC performance during the session. Samples should be dried before analysis, such as by a Nafion drier (Perma Pure Inc, Toms River, New Jersey) typically to a dew-point of -20 °C or lower. Water vapour has a diluting effect that leads to underestimated mixing ratios of SF<sub>6</sub> and CH<sub>4</sub>, by ~2.4% for water-saturated samples at 20 °C, but only 0.1% at -20 °C. While this does not affect the ratio [SF<sub>6</sub>]/[CH<sub>4</sub>], the magnitude of this effect can be different for breath and background samples, so that their subtraction (Eqn 11.3) would incur error. Furthermore, water degrades column performance, including retention times.

Most modern GC systems accommodate two detectors, which may be placed in series with a common GC column (the ECD is followed by the FID, because the latter consumes the sample), or in parallel. For the parallel configuration, each detector can have its own column and sample loop, designed to optimise analytical performance for SF<sub>6</sub> (ECD) and CH<sub>4</sub> (FID) separately, but with the minor drawback that they require a larger sample. Johnson et al. (1994, 2007) appear to use either two GCs or two columns in a single GC, with columns packed with Poropak N (CH<sub>4</sub>) and Molecular Sieve 5A (SF<sub>6</sub>). Both are held near 50°C. With separate columns, elution of each gas can take about one minute.

Lassey et al. (2011) described a two-column GC system (HP 5890 Series II) in an automated portable analytical laboratory near the penned experimental animals. Both columns were packed with Molecular Sieve 5A in an oven at 80°C, and used N<sub>2</sub> as carrier gas. Figure 8.1 shows a schematic of the GC configuration.

Apart from this example (Lassey et al, 2011), New Zealand researchers have used the simpler approach of a GC (either HP 5890 Series II, or Shimadzu GC-2010) with a single column packed with Molecular Sieve 5A in an oven at 80°C, with ECD and FID in series,

using N<sub>2</sub> as carrier gas. CH<sub>4</sub> elution takes longer in this configuration, at around 4.5 to 5 minutes.

With any such system, the Molecular Sieve column should be baked out regularly – preferably with the ECD isolated, as described by Johnson et al. (2007). This rids the column of slow-eluting gases including PVC plasticisers. The bake-out frequency depends on the extent to which such contaminants enter the main column, rather than being confined to, and flushed from, a pre-column (e.g., Figure 8.1).

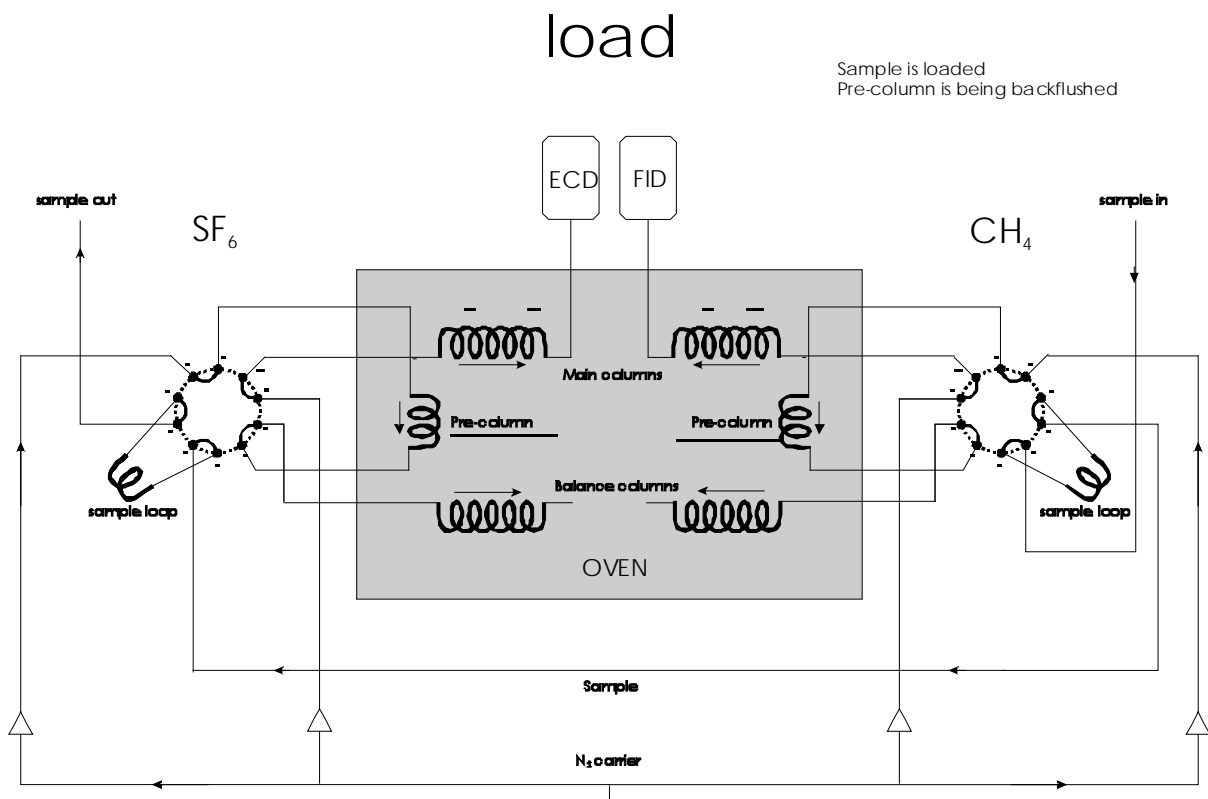

Figure 8.1: Schematic configuration of the two-column GC configuration, as implemented at NIWA and reported by Lassey et al. (2011).

*Of the two main columns – Alltech, 3 mm O.D, 2 mm I.D, both 2 m long and packed with Molecular Sieve 5A on a 60/80 mesh – that on the left is used for SF<sub>6</sub> detection by ECD, while that at right is used for CH<sub>4</sub> detection by FID. The carrier gas, zero-grade nitrogen, flows at ~30 ml/min. The oven is maintained at 80 °C and both detectors at 250 °C. The two 10-port valves are shown in 'load' phase, in which the dried sample is being loaded into both sample loops (volumes 1 ml for ECD and 3 ml for FID), while the respective pre-columns – identical to main columns except for lengths 0.2 m for ECD and 0.3 m long for FID – are being back-flushed by the nitrogen carrier gas to purge slower-eluting gases of no interest. The balance columns ensure that flows meet the same resistance during all phases.*

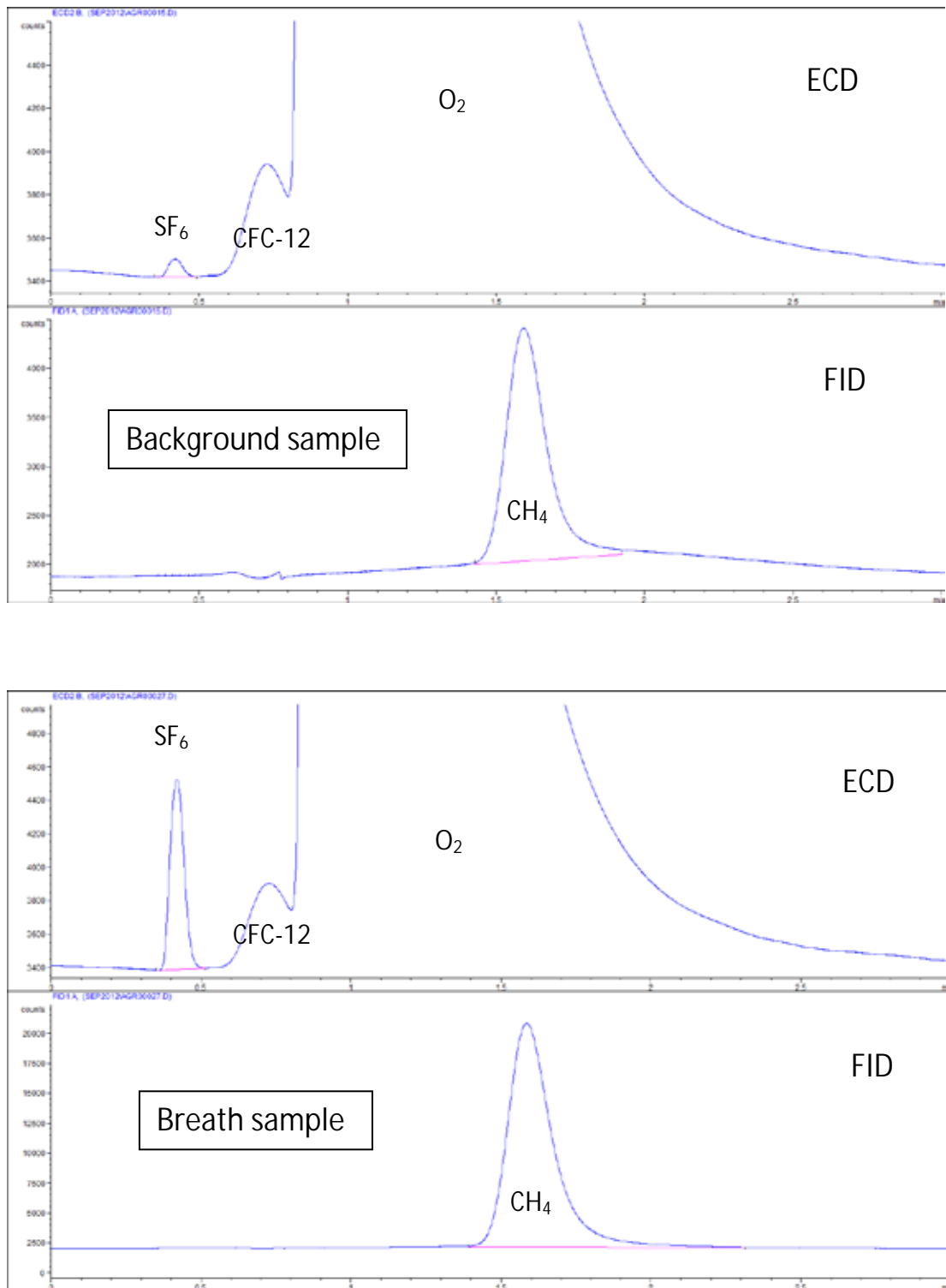

Figure 8.2: Representative chromatograms for a background sample (upper panel) and for a breath sample (lower panel), as determined and presented by ChemStation®.

The software associated with the HP 5890 Series II GC on which the samples were run, using the configuration of Figure 8.1 (Lassey et al, 2011).

*The abscissa is elution time (0-3 min), and the ordinate is counts recorded (scales differ among the panels).*

*The blue trace is as recorded from the detector, and the pink lines are ChemStation's best estimate of how to interpolate the baseline, and thereby estimate the peak area above that. It is clear that uncertainty associated with that interpolation means that the peak area for background is associated with greater relative uncertainty than the peak area estimated for a breath sample.*

*Note: the giant truncated O<sub>2</sub> peak on the ECD trace corresponds to elution of only a portion of the O<sub>2</sub> content of the sample – the interloping CFC-12 peak (a pervading atmospheric contaminant) can interfere with the SF<sub>6</sub> peak, and compromise peak area estimation if the peaks are insufficiently separated. The proximity of those three peaks (SF<sub>6</sub>, CFC-12, O<sub>2</sub>) dictates the length of the Molecular Sieve column: too short, and those peaks are not resolved.*

### **Chromatogram analysis**

GC software available with the GC system (e.g. ChemStation with Agilent GCs) is capable of providing analyses that recognise specified peaks, and estimate relevant peak areas used to deduce the relevant mixing ratios, including disentangling any overlapping peaks. Fig 8.2 shows a typical chromatogram for the two-column system of Lassey et al. (2011) for a representative breath sample, and for a representative background sample. Both CH<sub>4</sub> and SF<sub>6</sub> peaks are necessarily much smaller on the latter, and therefore quantified with greater relative uncertainty. In the case of SF<sub>6</sub>, the potential for interference from neighbouring peaks – notably atmospheric CFC-12 (Figure 8.2) – dictates the column length needed to separate those peaks.

A suite of standards is essential when deducing SF<sub>6</sub> and CH<sub>4</sub> mixing ratios from chromatogram areas. The FID has the advantage of being strictly linear over a broad range of mixing ratios; in other words, the area of the chromatogram peak associated with CH<sub>4</sub> is strictly proportional to the CH<sub>4</sub> mixing ratio. This means only a single CH<sub>4</sub> gas standard is needed – effectively to establish the constant of proportionality and monitor any drift over time. A CH<sub>4</sub> standard with mixing ratio near the centre of the encountered range of mixing ratios would be suitable. In New Zealand field work, a standard with [CH<sub>4</sub>] near 25 ppm, inter-calibrated against international standards (National Institute of Standards and Technology (NIST), Gaithersburg, MD, USA: [www.nist.gov](http://www.nist.gov)), is deployed.

By contrast, the ECD is generally not a linear detector. Typically, a power law relationship emerges between ECD response and [SF<sub>6</sub>], with exponent dependent on the GC configuration (e.g. Benner and Lamb, 1985), and potentially individual to the GC/ECD system (e.g., Figure 8.3). The exponent can be near unity with some configurations, implying near linearity. A power law implies linearity in log-log space, but in practice, such linearity is imperfect over the encountered range of [SF<sub>6</sub>] (Figure 8.3). Thus, as a minimum, three SF<sub>6</sub> standards should be considered, spanning the range of encountered mixing ratios. In New Zealand field work, three SF<sub>6</sub> standards

prepared by NIWA are deployed with validated [SF<sub>6</sub>] mixing ratios of approximately 20, 160 and 1000 ppt. These mixing ratios roughly span the [SF<sub>6</sub>] encountered in breath samples, and are in approximately geometric progression, which corresponds to equal spacing in log-log space. All NIWA standards are prepared with the same ratio of CH<sub>4</sub> to SF<sub>6</sub> mixing ratios, and the middle standard is also used as the CH<sub>4</sub> standard. NIWA has prepared standards for other research groups.

Non-linearity of the ECD has been confirmed for the high concentrations of SF<sub>6</sub> in breath samples from cattle dosed with high flow permeation tubes at Armidale, Australia (Hegarty et al, 2007.). More detail on this implementation is to be found in Section 8.3

### ***Implementation in New Zealand***

This section describes the analytical procedure to calculate [CH<sub>4</sub>] and [SF<sub>6</sub>] from the areas under corresponding chromatogram peaks, as developed by NIWA and adopted in New Zealand field work. Since c. 2001, all sample gases are undiluted, and extracted from the collection canister as described in Section 8.1, Option 3.

Gas standards are critically important to mixing ratio calculations. Several suites of three gas standards, denoted Lo, Mid and Hi, have been prepared at NIWA for use in New Zealand. They were prepared by diluting a parent gas ([CH<sub>4</sub>] = 745 ppm; [SF<sub>6</sub>] = 4850 ppt, supplied by Air Liquide in New Zealand) with zero-grade air as dilutant ([CH<sub>4</sub>] measured at 0.052 ppm; [SF<sub>6</sub>] below detection threshold) using calibrated mass flow controllers. Dilutions were cross-checked by measuring [CH<sub>4</sub>] and exploiting the linearity of GC/FID. NIWA holds several CH<sub>4</sub> standards, calibrated against NIST standards ([www.nist.gov](http://www.nist.gov)).

Aliquots of Lo, Mid, Hi were sent to the University of Heidelberg, a laboratory recognised for high-quality [SF<sub>6</sub>] measurements (Levin et al, 2010), which led to the reassignment of 4850 ppt for the parent gas from its original assignment of 5000 ppt by Air Liquide. Prepared standards are retained in Scott-Marrin cylinders with high-purity regulators ([www.scottmarrin.com](http://www.scottmarrin.com)). Each cylinder is plumbed to a Quick-Connect body (Swagelok) for easy interchange with gas collection canisters. Valves on the cylinders are always turned off when not in use, to preserve the contents.

The GC used in New Zealand is either Hewlett Packard's 5890 Series II, or Shimadzu's GC-2010 – sometimes both concurrently, depending on the number of daily analyses to be conducted. If both GCs are used, a suite of standards is associated with each GC. At the start and end of each session – usually a day – of GC analyses, the three standards – Lo, Mid, and Hi – are each run repetitively until stable SF<sub>6</sub> and CH<sub>4</sub> peak areas are achieved. Throughout each session, only Mid (being both a SF<sub>6</sub> and a CH<sub>4</sub> standard) is run, typically after every five to 10 samples. Each standard is run in triplicate (three aliquot) and each sample run in duplicate, or with further replicates as necessary to achieve stability in peak area (coefficient of variation <1%, except for background samples, where <7% is sufficient).

All sample aliquots are passed through a Nafion drier (MD-110-72, Perma Pure Inc, Toms River, New Jersey) on route to the GC sample loop(s). The mean peak area ( $A$  for SF<sub>6</sub> in Figure 8.3 and counterpart for CH<sub>4</sub>) of each stable triplicate or duplicate is then interpreted using a mathematical algorithm as follows, encoded in Visual Basic and run automatically via Excel macros.

The mathematical algorithm for CH<sub>4</sub> is straightforward. Each peak area  $A$  is related to  $A_o$ , the mean of the CH<sub>4</sub> peak areas in the nearest preceding and nearest succeeding runs of Mid. The sample mixing ratio associated with  $A$  is then calculated as:

$$[CH_4] = (A/A_o) \times [CH_4]_{std} \quad \text{Eqn 8. 1}$$

where  $[CH_4]_{std}$  is the CH<sub>4</sub> mixing ratio assigned to Mid.

The mathematical algorithm for SF<sub>6</sub> is complicated by non-linearity. The algorithm developed at NIWA exploits the near-linearity between log-transformed quantities (Figure 8.3 b, d). As with CH<sub>4</sub>, each  $A$  is related to  $A_o$ , the mean of the SF<sub>6</sub> peak areas in the nearest preceding and nearest succeeding runs of Mid. As Figure 8.3 confirms,  $V = \ln(A/A_o)$  is an almost linear function of  $\ln([SF_6])$ , and the small departure from linearity is adequately captured by an empirical quadratic relationship. Thus, with this model,  $V$  can be expressed in the form:

$$V = aU + bU^2 \quad \text{Eqn 8. 2}$$

where  $U = \ln(C/C_o)$ ,  $C = [SF_6]$ , and  $C_o = [SF_6]_{mid}$ , the SF<sub>6</sub> mixing ratio assigned to Mid.

Thus Eqn 8.2 empirically captures the curvature in Figs 8.3 b, d, with  $a$  close to 1.0, and  $b$  small but positive. The absence of a constant term in Eqn 8.2 follows from the definition of  $U$ , which ensures that  $U$  and  $V$  are simultaneously zero. Thus the constant terms in the regression fits of Figure 8.3 b, d equates to -

In the New Zealand protocol, both  $a$  and  $b$  are estimated each time all three standards are run to commence and end each session's analyses. These estimates follow because Eqn 8.2 applies also when Lo or Hi are the 'sample' for which  $C$  values are assigned. Values for  $a$  and  $b$  then emerge as solutions, when expressions of Eqn 8.2 for Lo and for Hi are treated as two simultaneous linear equations. All analyses conducted during the session use values for  $a$  and  $b$  that are the geometric means of those estimated at the start and end of that session.

With the above in place, it is straightforward to express  $U$  as a function of  $V$ , and the evaluated  $a$  and  $b$  by inverting Eqn 8.2 ('solving' Eqn 8.2 as a quadratic equation in  $U$ ):

$$U = \frac{2V}{a + \sqrt{a^2 + 4bV}} \quad \text{Eqn 8. 3}$$

This expression of the inversion is numerically stable, as it embodies the important property that as  $b \rightarrow 0$ , then  $U \rightarrow V/a$ . With  $U$  determined,  $[SF_6]$  is calculated as:

$$[SF_6] = \exp(U) \times [SF_6]_{mid} \tag{Eqn 8. 4}$$

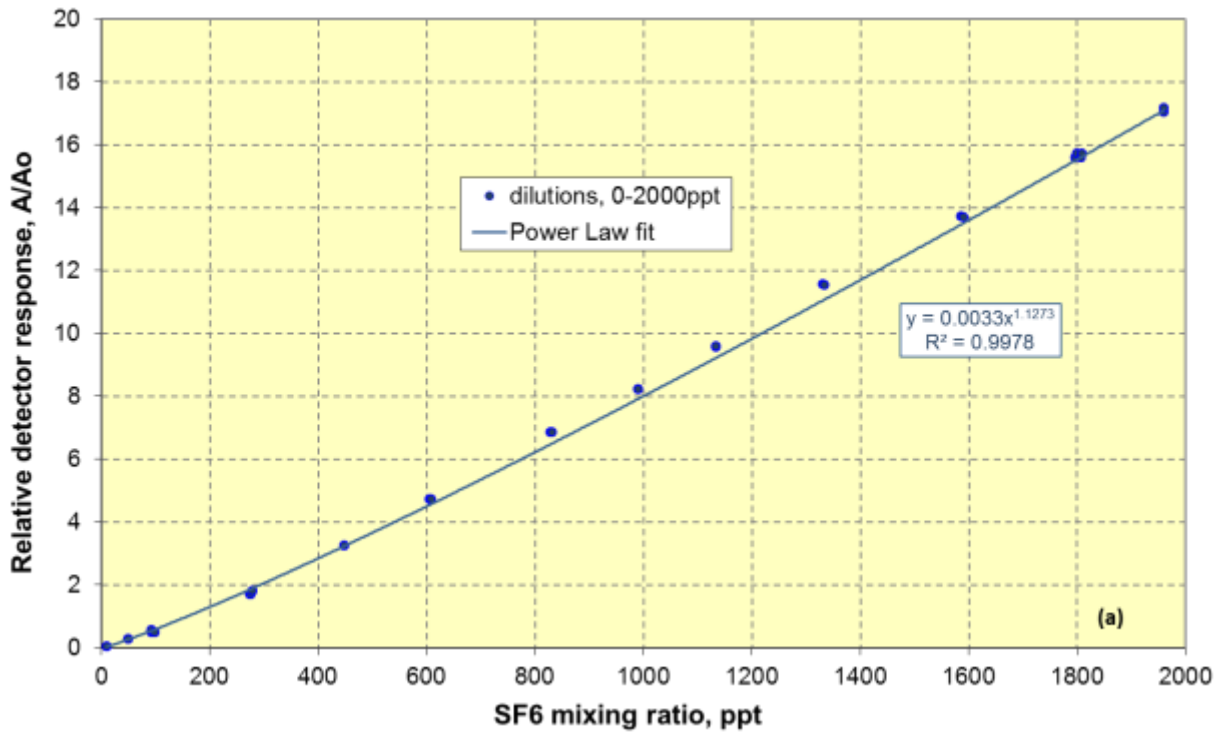



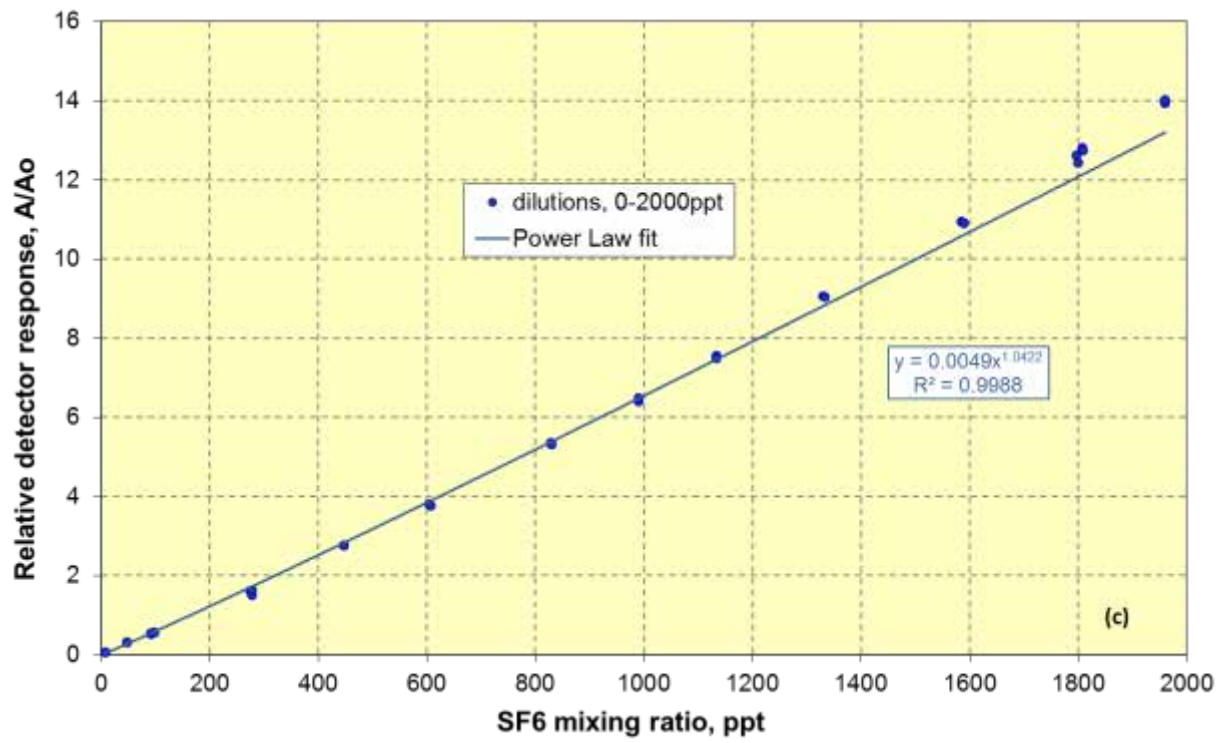
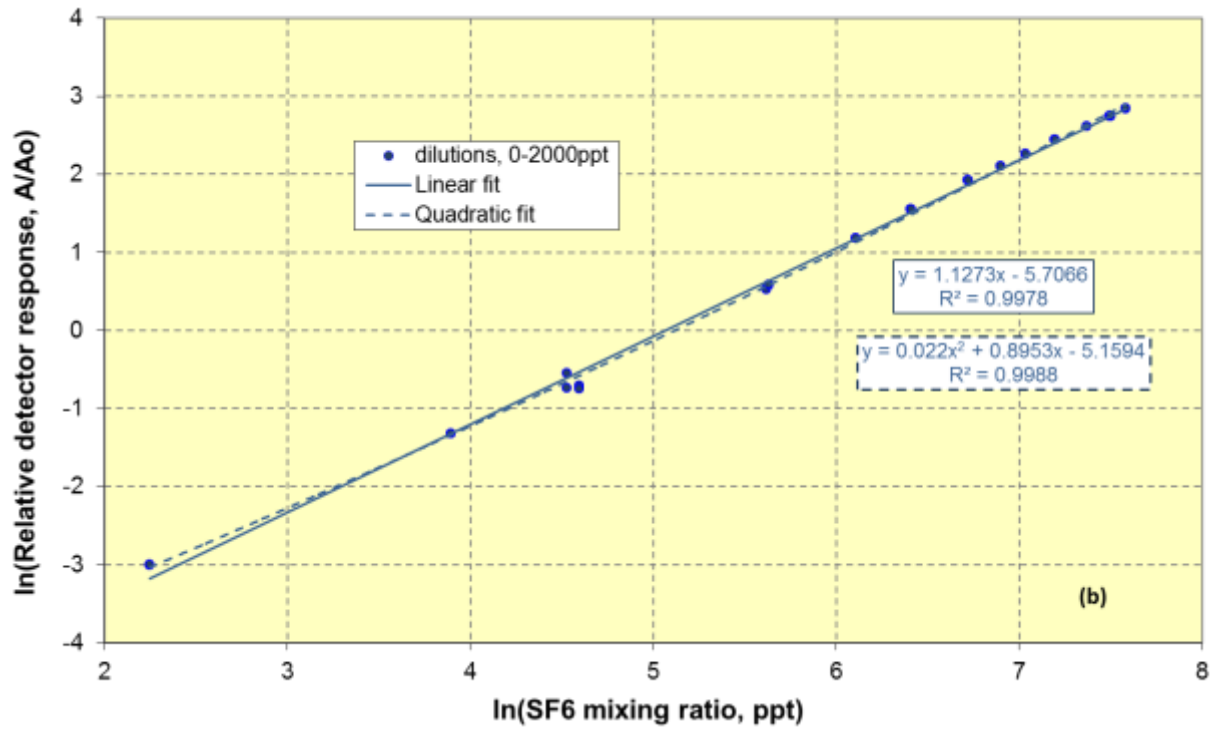

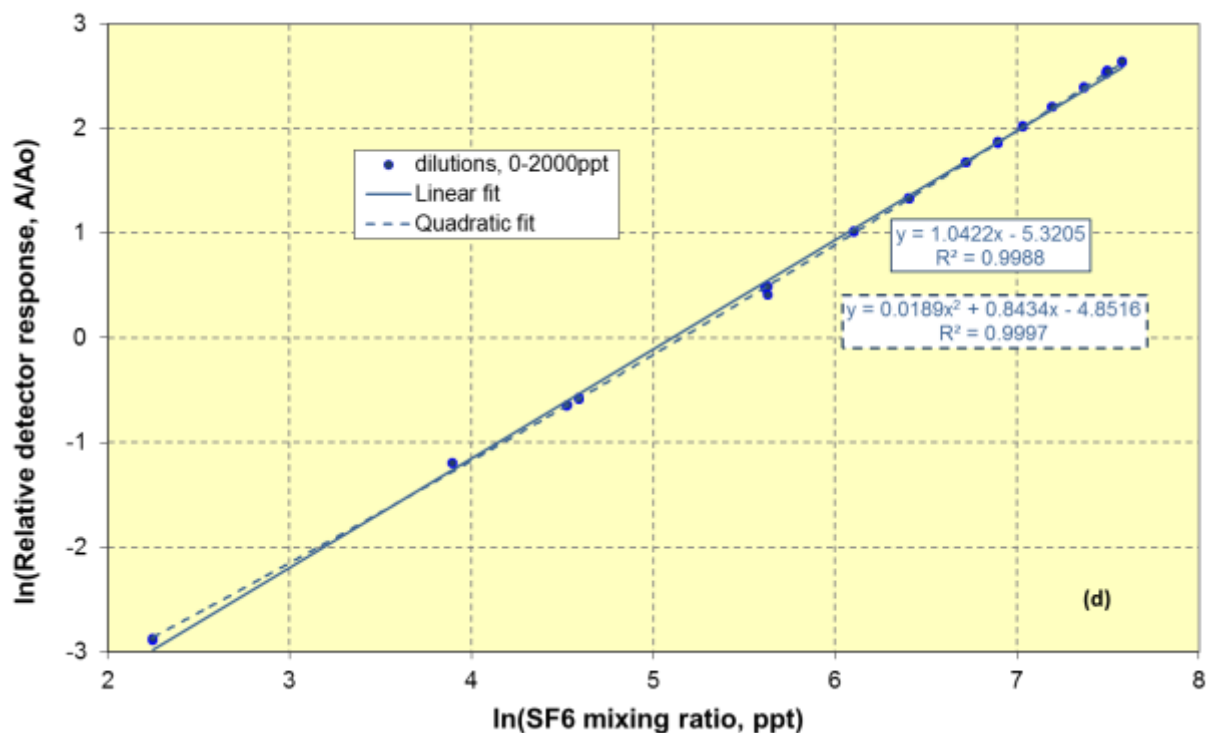

Figure 8.3: Relationships between ECD detector response to SF<sub>6</sub> (chromatogram peak area) in the eluting gas to SF<sub>6</sub> mixing ratio, [SF<sub>6</sub>], in a detailed calibration experiment conducted in December 2003 as a NIWA-AgResearch collaboration (New Zealand).

*In all cases, [SF<sub>6</sub>] is measured directly by the quantitative dynamic dilution of a parent gas (with [SF<sub>6</sub>] nominally 5000 ppt, subsequently cross-calibrated by University of Heidelberg and assigned 4850 ppt) with high-purity nitrogen (SF<sub>6</sub>-free). Calibrated mass-flow controllers accurately determine dilution factors, and also limit the dilution factors available. The plots cover [SF<sub>6</sub>] in the range 9.46–1961 ppt. Gas at each selected dilution is analysed repeatedly and accepted only when the three consecutive (triplicate) measured peak areas are stable. All detector responses, A, are expressed relative to A<sub>0</sub> which is the detector response to a NIWA-prepared standard ('Mid', assigned [SF<sub>6</sub>] = 162.6 ppt).*

*A run of Mid is alternated with every dilution run, and accepted when a stable triplicate is obtained. Specifically, A/A<sub>0</sub> is the peak area for the selected dilution, relative to the mean peak area of the immediately preceding and succeeding runs of the standard. This approach corrects for any drift in GC performance.*

*(a) shows a plot of A/A<sub>0</sub> as detected by a Hewlett Packard Series II HP5890 GC and ECD versus [SF<sub>6</sub>], together with a power law regression fit, with equation displayed in a text box on the plot. It is clear that the fit is non-linear, and a power law is adequate – but imperfect – over the full range.*

*(b) shows the same data as (a) on a log-log plot (natural logarithms), together with a linear regression fit (solid line with equation in solid-bordered box) and a quadratic fit (dashed line and dash-bordered box). It is clear that the linear fit reproduces the parameters of the power law fit in (a), viz exponent and slope of 1.1273. The quadratic fit to the log-transformed quantities provide a slightly superior fit over the 200-fold range of SF<sub>6</sub> mixing ratio.*

*(c) and (d) are exact counterparts of (a) and (b) for identical dilutions but detected by a Shimadzu GC-2010 and ECD. Both GCs were run simultaneously, with gas flow diverted from one to the other. Columns and temperatures were also identical. The features of (c) and (d) are qualitatively, but not quantitatively, similar to those of (a) and (b), illustrating the individuality of GC/ECD systems, including the power law exponent.*

### ***Implementation at Department of Primary Industries, Victoria, Australia***

At DPI Ellinbank, used canisters are flushed as described in Chapter 5, then evacuated. The vacuum of evacuated canisters ( $\tau_e$ ) is measured using a digital gauge (XP2i-DP, Crystal Engineering, San Luis Obispo, CA, USA, 0.01 kPa resolution) and recorded. It is important to use an accurate vacuum gauge, as the recorded vacuums are used in the calculation to correct for physical dilution of the sample. When the canisters have been used to collect breath samples, the vacuum ( $\tau_s$ ) of individual canisters is again measured using the same gauge and recorded. Ultra-high-purity N<sub>2</sub> (999.99 g/kg N<sub>2</sub>) is then added to each canister to achieve a vacuum of ~10 kPa, which is measured ( $\tau_f$ ) using the same gauge and recorded. A target of 10 kPa allows some room for overshoot. Canisters are then sent to the GC for gas analysis.

The GC used is a Varian CP-3800 (Varian Analytical Instruments, Walnut Creek, CA, USA) fitted with a 7 ml sample loop, and a Nafion dryer (MD-110-24F-2, Perma Pure, Toms River, NJ, USA) to dry the samples. Ultra-high-purity N<sub>2</sub> (999.99 g/kg N<sub>2</sub>) is used as the carrier gas. The N<sub>2</sub> gas, stored in a cylinder outdoors, is brought to room temperature by passing it through an extended, exposed length of ¼" (6.35 mm) copper pipe arrayed on the wall of the GC room (Figure 8.4). A stable carrier gas temperature is necessary to achieve a stable baseline in the chromatograms.



**Figure 8.4:** GC and copper tube array used to bring the temperature of the carrier gas to room temperature. At DPI Ellinbank, bottled gas is stored outside buildings for safety. In cold weather, it had been observed that the chromatogram baselines were unstable when the carrier gas was piped directly to the GC without temperature stabilisation.

Gas is transferred from a common sample loop through two parallel columns, one per detector, operated at 80°C. The CH<sub>4</sub> peak is separated using an Alltech Porapak-Q 80–100 mesh column (3.6 m × 3 mm stainless steel, Grace Davison Discovery Sciences, Deerfield, IL, USA) operating at a pressure of 310 kPa. Detection is by a flame ionization detector at 250°C. Separation of SF<sub>6</sub> is achieved using an Alltech Molecular Sieve 5A 80–100 mesh column (1.8 m × 3 mm stainless steel, Grace Davison Discovery Sciences, Deerfield, IL, USA) using a flow rate of 30 ml/min. Detection is by an electron capture detector operating at 300°C. The Molecular Sieve column is baked out overnight by slowly raising the oven temperature to 250°C, while bypassing the electron capture detector. The oven temperature is held for 10 hours, then slowly reduced to 80°C. Note that the Porapak column is isolated for the duration of this bake-out process.

Three NIST ([www.nist.gov](http://www.nist.gov)) certified gas mixtures (Scott-Marrin, Riverside, CA, USA) are used as standards to interpret the results from the GC. These are low ([CH<sub>4</sub>] = 20.37ppm, [SF<sub>6</sub>] = 18.66 ppt), medium ([CH<sub>4</sub>] = 63.9 ppm, [SF<sub>6</sub>] = 59.4 ppt) and high ([CH<sub>4</sub>] = 251 ppm, [SF<sub>6</sub>] = 240.3 ppt). Each standard is plumbed to a Quick-Connect fitting (Swagelok QC4-B-200) so it can be connected to the GC in the same way as the samples. Regulators on the standards are set to deliver the gases at 2 kPa, to minimise the difference in conditions between standards and samples. Each standard gas is drawn through the GC using the same process as that used for sample analysis (see below). An example calibration curve for SF<sub>6</sub> is shown in Figure 8.5.

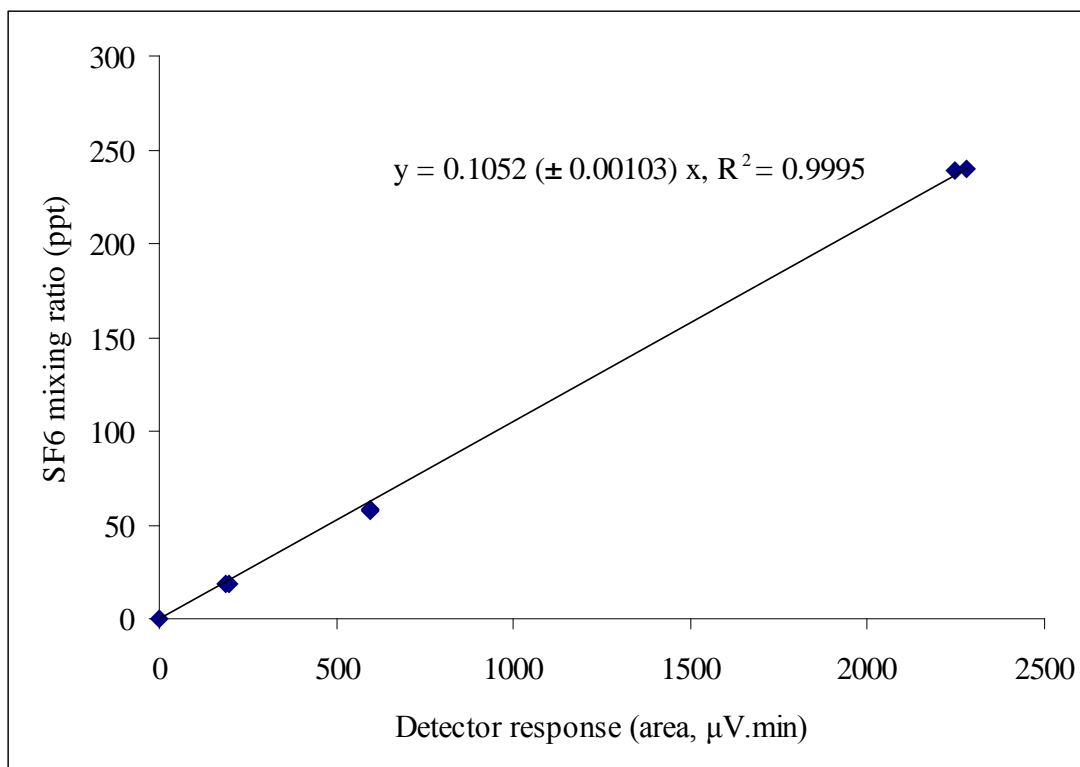

**Figure 8.5:** A typical linear GC calibration equation for SF<sub>6</sub> as determined at DPI Ellinbank. The three points or clusters, other than the origin, correspond to three standards.

Sample analysis immediately follows analyses of the three standards. After mounting a canister, the sample loop opens and a diaphragm pump (Thomas, 7006VD/2,3/E/AC, Gardner Denver Thomas Australia, Wetherill Park, NSW, Australia) connected to the GC exhaust is turned on, drawing the sample into the GC at ~30 ml/min for the 30 seconds the sampling loop is open (as per Section 8.1, Option 4). The pump's connection to the GC exhaust minimises the potential for cross contamination. The pump is turned off after the sampling loop has closed. Run time per sample is three minutes. Example chromatographs are shown in Figure 8.6 and Figure 8.7. Canisters are analysed sequentially until all samples have been analysed. The analysis sequence concludes with each of the three standards being analysed again, to check for drift in the GC. SF<sub>6</sub> and CH<sub>4</sub> mixing ratios are then estimated on the basis of linearity of detector responses.

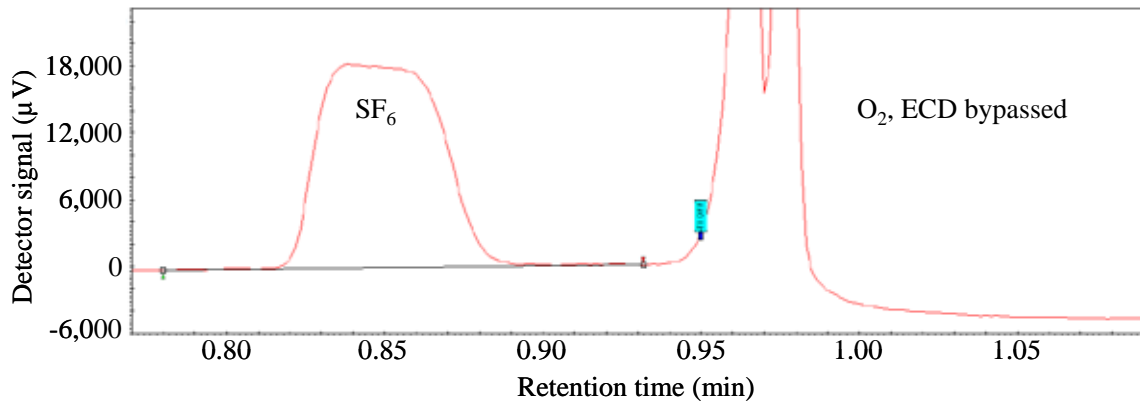

Figure 8.6: A typical DPI Ellinbank GC/ECD chromatogram, showing the SF<sub>6</sub> peak.

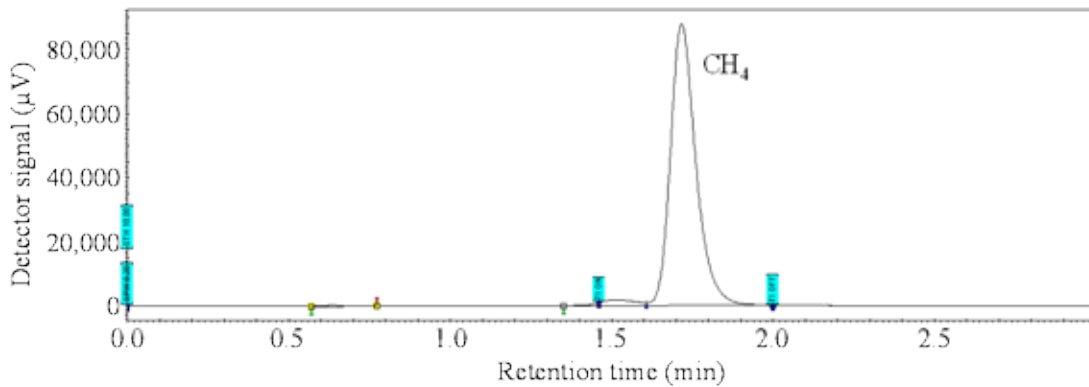

Figure 8.7: A typical DPI Ellinbank GC/FID chromatogram, showing the CH<sub>4</sub> peak.

Methane emissions are calculated in a two-part process: the first step is to mathematically account for the physical dilution of the samples with N<sub>2</sub> gas before analysis (Eqn 8.5).

$$[G_S] = \frac{101 - t_f}{t_e - t_s} \cdot [G_A] \quad \text{Eqn 8.5}$$

Where [G<sub>S</sub>] (same units as [G<sub>A</sub>]) is the calculated concentration of the gas as sampled, 101 is the average atmospheric pressure (kPa), τ<sub>f</sub> (kPa) is the final vacuum in the canister after the addition of nitrogen, τ<sub>s</sub> (kPa) is the vacuum in the canister after the sample is collected, τ<sub>e</sub> (kPa) is the vacuum in the evacuated canister before use, and [G<sub>A</sub>] (ppm for CH<sub>4</sub>, ppt for SF<sub>6</sub>) is the gas concentration in the sample presented to the GC.

Concentrations of SF<sub>6</sub> measured in background air samples at DPI Ellinbank tend to be similar to, but consistently higher than, those measured at Cape Grim Baseline Air

Pollution Station in northwest Tasmania (40° 41' S, 144° 41' E) (Figure 8.8): see also Levin et al. (2010) for Cape Grim data. This comparison between local and Cape Grim concentrations of background SF<sub>6</sub> serves as a valuable check that the collection, GC analysis and calculations have been completed satisfactorily, and that growth in background [SF<sub>6</sub>] is not an artefact of measurement. A persistent difference between Ellinbank and Cape Grim estimates is not of concern because the former carry greater uncertainty and, potentially, bias (Lassey, 2013).

The second step is to use the calculated gas concentrations to calculate the methane emissions as described by Williams et al. (2011) and in Chapter 10, (Eqn 10.3).

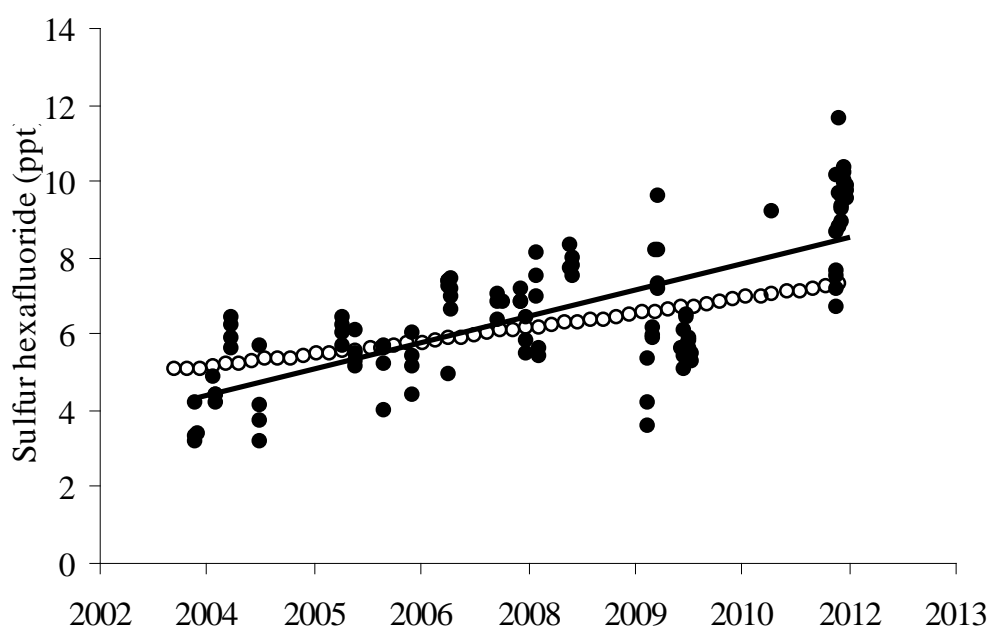

Figure 8.8: Concentrations of SF<sub>6</sub> measured in background air samples at Department of Primary Industries, Victoria, Australia (•; line shows linear trend) and atmospheric air samples at Cape Grim Baseline Air Pollution Station (o) located at Northwest Tasmania (40° 41' S, 144° 41' E). Cape Grim data courtesy Paul Krummel (CSIRO Division of Marine and Atmospheric Research – Aspendale, Australia).

### 8.3 Analysis by other technologies

Analysis of samples containing high levels of SF<sub>6</sub> (9–30 ppb) is conducted in Armidale, Australia (Hegarty et al., 2007), where breath samples are collected from cattle dosed with high-flow permeation tubes (Chapter 4). This process has not been validated for much lower (ppt) levels of SF<sub>6</sub>.

At Armidale, SF<sub>6</sub> is analysed by GC, while CH<sub>4</sub> is analysed separately using an Innova 1312 multi-gas analyser (Innova Airtech Instruments; Ballerup, Denmark) fitted with a photo-acoustic detector and equipped with moisture compensator. Standards for SF<sub>6</sub>



analyses are prepared daily, three sets per day, as a volumetric dilution series from a single SF<sub>6</sub> standard of 100 ppb (= 10<sup>5</sup> ppt) in nitrogen (Alpha standard, BOC Analytical Gases, Australia). Gravimetrically calibrated 50 ml and 1200 ml (SGE Analytical Science) syringes were used to manually and sequentially prepare standards of 100, 40, 16, 6.4, 2.56 and 1.28 ppb SF<sub>6</sub> in air, mixed in the 1200 ml syringe. A separate 50 ml injection syringe was flushed twice with 20ml of each standard drawn from the 1200 ml syringe, before being used for duplicate injection of that standard into the GC sampling loop (5 ml). No contamination of SF<sub>6</sub> was detectable in the injection syringe (<1 ppb) in blank (air) samples analysed at the start and end of each dilution series. The dilution series was prepared independently twice each day, with each calibration being used to quantify SF<sub>6</sub> in samples analysed in the 4 hours following the calibration.

Samples (1–2 L) are extracted from collection yokes into Tedlar bags using a piston pump (Model 2581C-02, Welch Thomas, Skokie, IL), no more than four hours prior to analysis (Hegarty et al., 2007). Each sample is analysed for SF<sub>6</sub> and CH<sub>4</sub> in duplicate. Like standards, samples for SF<sub>6</sub> determination are drawn into a 50 ml syringe after flushing the syringe twice with the same gas. The syringe is then manually connected to the GC, and an injected sample purges, then fills, the 5ml sampling loop. The GC configuration for this analysis is as described by Goldsack et al. (1979).

The daily protocol has a sample of ambient air injected onto the GC, then a set of calibration standards – prepared as above – are injected; then the background yoke samples and 12 breath samples (between 0800 and 1200 h). Ambient air and the second set calibration gases are then run, followed by a further 12 samples (1300–1700 h), with ambient air and the third set of calibration standards analysed again at the end of the day.

Peak areas from calibration sets before and after each 12 samples are averaged in converting SF<sub>6</sub> peak areas to mixing ratios, [SF<sub>6</sub>], for the intervening samples. A curvilinear regression is fitted ( $[SF_6] = y_0 + a.area + b.area^2$ ) using SigmaPlot (version 8.02A), where area = peak area units quantified by an integrator (Chromatopac C-R1B Data Processor, Shimadzu; Kyoto, Japan).

While a sample is being analysed for SF<sub>6</sub>, the host Tedlar bag is connected to the Innova 1312 multi-gas analyser for CH<sub>4</sub> analysis. A two-point methane calibration – using 0 and 100 ppm standards in air – is made at the start, middle and completion of a day's analyses. In some studies, a mixed high standard (100 ppm CH<sub>4</sub>, 4000 ppm CO<sub>2</sub>) was used to obtain CO<sub>2</sub> concentration data from this instrument. A cross-interference correction for water is always switched on in the Innova 1312 to avoid having to dry the sample.

The Innova 1312 can measure five gases per sample, and has a claimed detection limit for SF<sub>6</sub> of 2 ppb, so should have been capable of direct simultaneous infra-red measurement of SF<sub>6</sub> as well as CH<sub>4</sub> and CO<sub>2</sub> in these samples. However, cross-interference with SF<sub>6</sub> from unknown compounds occurred in samples collected in yokes made from a range of plastics and of aluminium. Inclusion of a 5 ml in-line clean-up column packed with A20 activated carbon significantly reduced this interference,

but the authors were not confident to measure SF<sub>6</sub> in yoke samples by this instrument below 100 ppb SF<sub>6</sub>, making the Innova 1312 unsuitable for infrared SF<sub>6</sub> determination of breath samples as collected.

## 8.4 Intermediate sample storage

It may not always be possible to analyse samples directly from the collection canister within 24 hours of collection, thereby assuring a quick turnaround of canisters. Without a 24-hour turnaround, a lot more canisters would be needed to effect successive 24-hour collections. As canisters are both cumbersome to store (and therefore expensive to ship), and expensive to buy or fabricate when compared to vials, they do not make ideal sample storage receptacles. Hence, several research groups have developed techniques to transfer sub-samples from canisters into vials for storage and/or for efficient transport to a specialist laboratory. The following sections describe such experiences.

In sample transferral and vial storage, it is important to recognise the risk of loss or contamination of samples due to leaky vials, including cross-contamination among co-packaged vials, especially when shipped over long distances and/or kept in the vials for long periods. Attention to sample integrity is critically important; in particular, it is good practice to over-pressure the vials to circumvent inward leaks. But samples at or near atmospheric pressure at the filling site could still leak during transit where local atmospheric pressure changes. Anecdotally, there have been many studies that have failed due to leaky vials.

### *The Canadian experience*

Motivated mainly by a need for fast turnover of canisters (PVC yokes), the research team at Agriculture and Agri-Food Canada – Semiarid Prairie Agricultural Research Centre (AAFC-SPARC) introduced a modification to the yoke design that incorporated a septum to enable manual extraction of a gas subsample.

The SPARC SF<sub>6</sub> PVC collection yoke was modified by attaching a sub-sampling port, connected to the Swagelok Quick-Connect body via a ¼" (6.35 mm) T branch (NAPA p/n 3600×4: Swagelok) screwed into the yoke (Iwaasa et al., 2004; McGinn et al., 2006). Key to the sub-sampling port is a blue silicone/butyl septum, 9.525 mm diameter and 3.0 mm thick (Mandel Scientific A-6514). As a valuable and vulnerable part of the SPARC SF<sub>6</sub> PVC yoke, the Quick-Connect and sub-sampling port body is guarded by a PVC surround for additional protection (Figure 5.5).

After a 24-hour collection period, the yoke is over-pressured by about 100 kPa by slowly adding N<sub>2</sub> gas (99.999%). It was found that after pressurisation, the N<sub>2</sub> gas must be allowed to equilibrate/mix for at least one hour to achieve a stable concentration in withdrawn sub-samples. After this time, a sub-sample is taken from the sampling port on the yoke using a 25 gauge needle attached to a 20 mL syringe. Initially, about 5–10 mL of gas is sampled, then vented to avoid contamination associated with dead volume in the syringe and needle. A 20 mL gas sample is then taken, and injected into

a 5.9 or 12 mL Soda glass vial exetainer (Labco) with screw caps and double-wadded septa with Teflon and silicone. Before use, exetainers have been evacuated to less than 0.01 kPa. From each yoke, three sequential 20 mL subsamples were taken and transferred to three exetainers for later CH<sub>4</sub> and SF<sub>6</sub> analysis.

The general recommendation is that GC analyses should be conducted as soon as possible. However, standards have been run from the same exetainers after one to two months of storage with no detected problems. Another general conservative recommendation is that each blue silicone/butyl septum in the sub-sampling port and the double-wadded Teflon/silicone septa in the exetainers should only be injected ten times before being replaced.

### ***The New Zealand experience***

New Zealand, researchers have developed techniques to sub-sample from unmodified collection canisters (PVC yokes) into vials without prior dilution. Sub-sampling lessens the number of yokes required for successive daily breath sampling from ~60 sheep, and avoids the onerous burden of analysing >60 samples per day at the field site, some distance from the main analytical laboratory at NIWA (Wellington).

Along with a number of GCs, NIWA's gas-analysis laboratory has a Gilson auto-changer, with a GC interface controlled by LabView<sup>®</sup> software on a laptop computer. The auto-changer tray can be loaded with up to 220 vials (12 ml soda-glass 'exetainers' with screw caps and butyl septum: Labco, UK). Once set up, the LabView<sup>®</sup> software controls the unattended successive analyses of the supplied vials, interspersed with analyses of a supplied standard. Teflon and/or silicone linings, are not used in the butyl septa, because of the known interactivity between Teflon and SF<sub>6</sub>, and the suspicion that silicone is porous to some gases.

Under LabView control, the vials are sampled and analysed sequentially, using a conical-tip needle with a side port (21 Gauge, 0.8 mm o.d, stainless steel luer hub needle, Hamilton 7729-08 from Grace Davison Discovery Sciences, Rowville, Vic, Australia). These needles are designed to penetrate septa and thin gauge vinyl and plastics without coring, thereby minimising septum damage and prolonging septum life (cf. the more common broader-gauge intravenous needle, which can cut the septum).

Under software control, one tray of up to 220 vials can be analysed in about 16 hours, interspersed with analyses of a standard supplied in a pressurised cylinder (NIWA's 'Mid' standard), and can run unattended overnight. Each session is preceded and succeeded by a sequence of all three SF<sub>6</sub> standards, as per Section 8.2. The aim is to analyse samples within one week of collection, though tests with one month storage have shown good sample integrity in exetainers.

Sub-samples are transferred from yoke to vial at the experimental venue. The NIWA-designed piston extractor (Section 8.1) has been adapted to transfer a sub-sample using the yoke's standard Quick-Connect simultaneously to each of three vials (replicates), allowing the yoke to be then re-evacuated for reuse. The adaptation uses a purpose-designed manifold that places the three vials in parallel, under control of a

manually switched pneumatic valve. The extractor device first simultaneously evacuates the piston chamber, the manifold and connection tubing up to the Quick-Connect, including the three vials via the side-entry needles (<0.01 kPa). Then, without withdrawing the needles, a switched valve exposes the manifold to the sample, transferring a sub-sample simultaneously into each of three vials to an over-pressure of 200 kPa.

That overpressure (24 ml at STP) is sufficient for one sample analysis in the GC, including purging of the preceding sample. Because of the overpressure, vials with screw caps are used, rather than push-caps. A technician can conduct and record about eight transferrals – yoke to three vials – per hour, which far exceeds throughput of triplicate samples and standards by in-situ GC analysis. With sub-samples extracted, the yoke can then be evacuated (<0.1 kPa) without flushing for later reuse.

The pump used in each operation to achieve the steady vacuums is a Hivac TRP-12 ([www.hivac.co.nz](http://www.hivac.co.nz)), with rated pumping speed of 170 L/min.

This system has worked flawlessly in three field campaigns to date, with no renewal of septa. Each septum is punctured only twice per use: once at the experimental site (evacuation, sample injection), and once in the analytical laboratory (sample extraction).

In this way, an experimental campaign with up to 73 samples per day, including backgrounds, can be sub-sampled by one on-site technician to provide triplicate sub-samples for one 220-vial tray for later overnight analysis. This protocol can, in principle, be extended to a greater number of daily samples if logistics, including the requisite number of vials, permit.

### ***The Brazilian experience***

Because of the large distances between field sites and laboratories – as large as 1,500 km in the case of one field site in Amazonia – the research team at Embrapa developed a system to split the canister sample into vials and send the boxed vials by post. The vial configuration varies, according to the auto sampler of the target GC system. In all cases, borosilicate glass and double-sided (Teflon and silicone) septa are desirable, to prevent gas loss from the vial. The septum was found to be the most fragile point of storage, because of the need to puncture it three times: first to apply the vacuum, second to inject the sample and third to transfer the sample to the GC (manually or automatically).

Manufacturers usually recommend discarding the septum after only one use. However, it is possible to check the integrity of each septum brand after multiple punctures, using a gravimetric method as follows: individually weigh a batch of ~100 new vials (10 or 20ml La-Pha-Pack vials: [www.la-pha-pack.com](http://www.la-pha-pack.com)) with air inside at atmospheric pressure. Then apply a vacuum to 10 vials by puncturing once with the needle normally used to transfer the sample (0.45 × 13 mm). Puncture another 10 vials with two holes, another 10 with three holes, etc, with the last hole made by a needle connected to the vacuum pump and used to evacuate the vials.

All 100 vials are weighed after evacuation, and again daily for as long as would be expected between field collection and analysis. An inward leak of air from atmospheric pressure is easily identified by the weight increasing toward the full-of-air weight (20 ml of air has mass ~25 mg at STP). Embrapa Southeast Livestock have found that 100% of septa reliably retain a vacuum after four punctures, falling to 65% after the fifth puncture.

Once the vial brand is chosen, and the number of acceptable punctures is defined, it is important to evacuate replicate vials (typically five) to equal residual pressure, so that the replicate samples are all diluted equally (and minimally) by that pressure. A device was developed (Figure 8.9) to simultaneously apply the vacuum in five (or more) vials, transfer the sample from the canister and fill them to the same positive pressure. The device consists of two parts: one fixed base, to which the vials are affixed, and another moving part with five parallel needles aligned with the centre of each septum of the vial.

When the movable part descends to meet the vials, the needles pierce the septa at the same time. On the way back, the moving part ascends, and all the needles leave the septa at the same time. On the top of the moving part, a three-way Swagelok valve allows two different flows from or to a common manifold, to which the five needles are connected through tubing. One flow is to the vacuum pump, and the other from the sample canister, which has been pressurised with pure nitrogen to an over-pressure of ~100 kPa.

First, the valve position exposes all the five vials and connected tubing to the vacuum pump, to achieve the maximum vacuum (<10 kPa absolute). Then the valve is switched, so that the canister sample is immediately transferred in part to the vials and at near-undiminished pressure (~200 kPa absolute). This process standardises the sub-samples from the same canister, minimising errors due to different vacuums, volumes transferred and positive pressures. After this process, the vials will receive only one further puncture, enabling a useful septum life of two cycles each. The Embrapa team is still evaluating this system, and testing for how long can the samples be transported or stored from collection until analysis.





Figure 8.9: The Embrapa (Brazil) system for transferring samples from collection canister to 20 ml vials.

*See text for details. Photo courtesy of Alexandre Berndt, Embrapa.*

## 8.5 References

- Benner, R.L & Lamb, B, 1985. A fast response continuous analyzer for halogenated atmospheric tracers. *J. Atmos. Oceanic Tech.* 2, 582-589.
- Goldsack, R.J, Hawke, G.S & Tio, P.H, 1979. Atmospheric dispersion experiments in the Sydney region. *Clean Air* 13:57-61.
- Hegarty R.S, Goopy, J.P, Herd, R.M & McCorkell, B, 2007. Cattle selected for lower residual feed intake have reduced daily methane production. *J. Anim. Sci.* 85, 1479-1486.
- Iwaasa, A.D, Stumborg, M.A, Wittenberg, K.M, McGinn, S.M & McAllister, T.A, 2004. Development of a cost-effective and simple sampling apparatus and PVC collection yoke system for methane measurement from grazing ruminants using the SF<sub>6</sub> technique. Canadian Society of Animal Science Conference on the Science of Changing Climates, Edmonton 20–23 July, 2004.
- Johnson, K, Huyler, M, Westberg, H, Lamb, B & Zimmerman, P, 1994. Measurement of methane emissions from ruminant livestock using a SF<sub>6</sub> tracer technique. *Environ. Sci. Tech.* 28, 359-362.
- Johnson, K.A, Westberg, H.H, Michal, J.J & Cossalman, M.W, 2007. The SF<sub>6</sub> technique: methane measurement from ruminants, In: Makkar, H.P.S, Vercoe, P.E. (Eds.), *Measuring methane production from ruminants*, Springer, Dordrech, Netherlands, pp. 33-67.
- Lassey, K.R, 2013. On the importance of background sampling in applications of the SF<sub>6</sub> tracer technique to determine ruminant methane emissions. *Anim. Feed Sci. Tech.* 180, 115-120.
- Lassey, K.R, Pinares-Patiño, C.S, Martin, R.J, Molano, G & McMillan, A.M.S, 2011. Enteric methane emission rates determined by the SF<sub>6</sub> tracer technique: temporal patterns and averaging periods. *Anim. Feed Sci. Tech.* 166–167, 183-191.
- Levin, I, Naegler, T, Heinz, R, Osusko, D, Cuevas, E, Engel, A, Ilmberger, J, Langenfelds, R.L, Neininger, B, v. Rohden, C, Steele, L.P, Weller, R, Worthy, D.E & Zimov, S.A, 2010. The global SF<sub>6</sub> source inferred from long-term high precision atmospheric measurements and its comparison with emission inventories. *Atmos. Chem. Phys.* 10, 2655–2622. ([www.atmos-chem-phys.net/10/2655/2010/](http://www.atmos-chem-phys.net/10/2655/2010/)).
- Martin, R.J, Bromley, A.M, Harvey, M.J, Moss, R.C, Pattey, E & Dow, D, 2011. The “Lung”: a software-controlled air accumulator for quasi-continuous multi-point measurement of agricultural greenhouse gases. *Atmos. Meas. Tech.* 4, 2293-2303. ([www.atmos-meas-tech.net/4/2293/2011/](http://www.atmos-meas-tech.net/4/2293/2011/)).



McGinn, S.M, Beauchemin, K.A, Iwaasa, A.D & McAllister, T.A, 2006. Assessment of the sulphur hexafluoride (SF<sub>6</sub>) tracer technique for measuring enteric methane emissions from cattle. *J. Environ. Qual.* 35: 1686-1691.

Williams, S.R.O, Moate, P.J, Hannah, M.C, Ribaux, B.E, Wales, W.J & Eckard, R.J, 2011. Background matters with the SF<sub>6</sub> tracer method for estimating enteric methane emissions from dairy cows: A critical evaluation of the SF<sub>6</sub> procedure. *Anim. Feed Sci. Techn.* 170, 265–276.

## 9 ANIMAL MANAGEMENT AND FEED INTAKE

G.C. Waghorn<sup>a\*</sup>, C. Pinares-Patiño<sup>b</sup>, G. Molano<sup>b</sup>, A. Berndt<sup>c</sup> & C. Martin<sup>de</sup>

<sup>a</sup>DairyNZ, Hamilton, New Zealand

<sup>b</sup>AgResearch Limited, Palmerston North, New Zealand

<sup>c</sup>Embrapa, Fazenda Canchim, São Carlos, SP - Brasil

<sup>d</sup>INRA, UMR1213 Herbivores, Saint-Genès-Champanelle, France;

<sup>e</sup>Clermont Université, VetAgro Sup, UMR1213 Herbivores, Clermont-Ferrand, France

\*Corresponding Author: G.C. Waghorn [garry.waghorn@dairynz.co.nz](mailto:garry.waghorn@dairynz.co.nz)

---

Methane (CH<sub>4</sub>) is derived from anaerobic digestion of feed, mainly in the rumen, and CH<sub>4</sub> production is largely determined by the amount of feed eaten. When calculating CH<sub>4</sub> yield (CH<sub>4</sub>/unit of feed intake), an accurate measure of intake is just as important as an accurate measure of CH<sub>4</sub>. The SF<sub>6</sub> technique is important, because it enables CH<sub>4</sub> production to be measured in environments that are typical of commercial husbandry.

The SF<sub>6</sub> technique allows CH<sub>4</sub> measurement from unrestrained animals, which therefore exhibit 'normal' behaviour such as grazing. But in many instances, the technique is used with animals confined in pens or metabolism crates. Because most of the world's ruminants graze outdoors, measurements made from grazing animals may best represent the population of animals managed on farms. They choose their diet, and when to eat, ruminate and rest. The importance of grazing behaviour – and grazing regimens – should not be underestimated in terms of production, digestion and possibly, CH<sub>4</sub> emissions.

The alternative 'cut and carry' feeding of confined or restrained animals provides feed at times determined by experimental protocols, often with higher intakes compared to competitive grazing. Forage is cut to a defined length, and intakes are rapid. Nevertheless, if intake measurement is an important aspect of an experimental protocol, feeding measured amounts, and collecting uneaten feed (refusals, orts) is the only way to ensure an accurate measurement.

The SF<sub>6</sub> technique applies to different ruminant species under a wide range of circumstances, but in practice, most measurements have been confined to sheep, cattle and some deer. Few measurements have been made with males (other than

castrates) or animals that have not had frequent contact with humans. The SF<sub>6</sub> method involves frequent – often daily – handling during the measurement period: fitting halters and gas collection canisters and ensuring the tubing, or ‘plumbing’, remains intact.

It is important that animals are reasonably docile. There is nothing to be gained from trying to measure CH<sub>4</sub> production from angry animals, other than poor data, broken equipment and injuries to humans and animals. Animals should be sufficiently calm for equipment to be attached and changed without headstocks, because neck restraints prevent neck yokes being fitted, and damage can occur when the animal is released. *Bos indicus* is naturally more agitated and averse to human contact, and typically demands two to three months of careful care during domestication. Young animals can become very docile following domestication, but it is best to identify aggressive animals and exclude them prior to training to ensure success. This applies to all species and breeds.

The experimental objective should determine both the choice of protocol – whether SF<sub>6</sub> or another method should be used for measuring CH<sub>4</sub> – and the requirements for intake measurement (Table 9.1).

***The importance of the objective cannot be overstated***, especially when it defines grazing vs. indoor feeding. Are intake measurements really necessary? Could they be predicted from energy requirements for maintenance and measured production? How accurate should the measurements be? Indigestible markers, faecal ‘grab’ samples or pre- and post-grazing pasture cuts can give an indication of intakes, and avoid the need for cut-and-carry, which means intakes can be measured indoors. However, there is a risk of under-estimating CH<sub>4</sub> yields if predicted intakes are used, because any reduction in actual intake (in response to the measuring equipment) will lower CH<sub>4</sub> yields. Of course, these considerations only apply to animals grazed outdoors.

The SF<sub>6</sub> technique has been used to estimate CH<sub>4</sub> production in countries such as Australia, Argentina, Brazil, Canada, China, France, Ireland, New Zealand, United Kingdom and the United States. When protocols have been followed, the data have been assumed to be representative of the actual emissions. Indeed, emissions calculated from the SF<sub>6</sub> method have been compared with respiration chambers in cattle (McGinn et al., 2006; Grainger et al., 2007; Muñoz et al., 2012) and sheep (Hammond et al., 2009) with good agreement.

However, when sufficient data became available, Vlaming et al. (2005; 2007) demonstrated a positive relationship between SF<sub>6</sub> permeation rate and estimates of CH<sub>4</sub> production, and this warrants further investigation. Other concerns with this technique were highlighted when low CH<sub>4</sub> yields (g/kg dry matter (DM) intakes) measured from sheep fed either fresh white clover (*Trifolium repens*) (Krause; unpublished) (14-16 g/kg DM intake) or chicory (*Cichorium intybus*) (Waghorn et al., 2002) (16.2 g/kg DM intake) were reassessed using respiration chambers. Chamber measurements showed CH<sub>4</sub> yields from sheep fed white clover were 19.8-27.1 g/kg DM intake (Hammond et al., 2011), and 22.8 g/kg DMI from chicory (Sun et al., 2011).

Intake level may have accounted for some of the discrepancies between SF<sub>6</sub> and chamber values (Hammond et al., 2013), but much of the difference between measurements methods remains unexplained.

This chapter considers three aspects of measurement in farm animals; animal handling and management, intake measurement, expression of CH<sub>4</sub> and diet composition.

## 9.1 Animal handling and management

The SF<sub>6</sub> technique requires eructated and respired gas to be collected from near the nostrils, and the sample stored in evacuated canisters that are changed when they are between 50 and 70% full. The sampling tube must be attached to the animal in a way that maintains its position near the nostrils at all times, whether eating, drinking, scratching or any other activity. Usually, it is connected to a halter securely fastened to the animals head. A 'nose flap' or similar may need to be fitted to ensure the sampling tube is located appropriately, and the tube should have two openings in the shape of a 'y', to minimise the chance of water blocking the capillary tube when the animal is either drinking or grazing wet pasture. The actual position of the sampling tube is not important, provided the collected gas concentrations are about 10 times their concentration in background air.

**Halters** are the standard method of attaching the sampling tube, and any well-constructed (i.e., several adjustable straps) version is suitable, provided it fits firmly without rubbing. Halters for cattle seem to fit easily and well, but sheep can be more difficult, depending on wool length and halter design. It is probably easier to work with sheep that have comparatively little wool around their head and neck, which means the halter can be positioned easily and securely. Halters may be fitted one or two days before sample collecting, so animals become accustomed to them and to people. It is probably best to commence measurements from all animals in a trial at a similar time.

The **canister** design (Chapter 5) may affect animal handling and operator safety. Early trials in New Zealand placed 'training' neck canisters on sheep and cattle, so they became accustomed to the equipment before measurements commenced. In Brazil, most trials with cattle use training halters and canisters (without tubes and connections) for at least four days before the collection period. The need for training halters can also be assessed by measuring CH<sub>4</sub> production over sequential collection days. Brazilian work has not shown any changes in emissions measured over five days following a four-day training period.

The **animal handling requirements** for collection canisters are similar to those for fitting halters, but care is essential to make sure the animals are not harmed by the equipment. Girth straps holding back-mounted canisters can cut and abrade behind the front legs, and the canisters themselves can damage the skin over the spine. These require straps around the brisket, in addition to the girth strap, rather than very tight girth straps alone. The use of shoulder and saddle collection canisters has been restricted in some centres because careless or poor fitting by some operators caused rubbing and pressure damage.

On housed animals, collection canisters must sometimes be mounted in alternative ways: for example, neck-mounted yokes are not appropriate when animals are eating from Calan gates, Grow Safe or any facility with a narrow access point to feed. Individual animals held in metabolism stalls may have the collection canister mounted off the animal, in which case the tubing connecting to the halter should be positioned so the animal cannot chew it. This may be achieved if it is attached behind the head, or between the shoulder blades, and if the tubing is supported by elastic (7-10 mm, used in clothing) it will remain out of reach when the animal stands or lies down.

Other systems include mounting under the jaw, attached to the halter, but these may interfere with grazing. Animal care and welfare is essential from both an ethical perspective and because an ill-treated animal will yield poor quality information.

When **fitting halters, harnesses and canisters**, it is preferable that animals are sufficiently docile that head and/or neck restraints (or crushes) are not necessary. In our experience, it is better to spend time working with the animals for days or weeks before the measurements, so they become accustomed to handling, rather than impose halters and other collection equipment on stressed sheep, cattle or deer.

We should aim for 100% success with collections, and if the collection rate is less than 80%, something is wrong with the equipment installation, animal training or operators. Problems arise from loose tubing, stressed animals and inadequately trained personnel fitting and changing equipment incorrectly. Experienced personnel will observe, identify and remedy potential problems: are connectors fitted properly? Are tubes intact, stretched or broken? The vacuum in the canister must be checked when placed on, and removed from, the animal, and collections should be avoided in very wet conditions because tubing will block. Attention to detail will improve the quantity and quality of samples obtained, but often, only 70% of collections (with appropriate vacuum) from grazing animals are successful. In this situation, it is important to allow extra days for measurement, so as to obtain sufficient robust data.

Experimental animals should be split into **groups** of less than 15, to minimise equipment damage when they are brought into the yards, and to maximise their grazing time – large groups take time to process, so there is less time available for grazing. Keeping groups small, and having enough operators on hand, will ensure the rapid exchange of canisters. Keep spare halters and canisters handy should any need replacing.

It is also important to consider herd hierarchy: mixing animals from different herds immediately before the collection period might see equipment damaged as animals establish a new dominance relationship. When animals alter their behaviour in this way, they probably eat less and spend more time and energy on social interactions, which means data quality can be compromised.

Any **reduction in intakes** attributed to the equipment will affect measurements and interpretation, and this could prejudice data accuracy – especially where intakes were calculated or estimated. Most sheep and dairy cows have little problem with

measuring equipment, but young animals appear to reduce their intakes – for one or two days, at least – when measuring apparatus is placed on them. However, once accustomed to the halter, the canister appears to have minor effects on behaviour of mature sheep and cattle. This means measurements may be taken from the time the canister was fitted. Fitting halters takes time, so the halter may be fitted one or two days prior to placing the canister on the animal.

Determining an animal's appropriate adjustment period must be made with specific experimental situations in mind. Any impact from the canister can be assessed by comparing emissions on day one with those on subsequent measurement days.

The **optimal number of collection days** does not appear to have been determined. In Brazil, five days of measurements from cattle are recommended – including additional collection days if some data are discarded – and this has resulted in consistent emissions without trends over the collection period. Measurements from cattle in New Zealand have occasionally shown oscillations in daily emissions (a two-day cycle). The cause has not been identified, but it could be the intermittent equilibration of SF<sub>6</sub> in rumen head-space gas. Defensible measures of CH<sub>4</sub> made using SF<sub>6</sub> must be undertaken over at least four days, because the data will be more representative than from shorter measurement periods, and any trends over time can be recognised over a period of four or more days. We suggest a minimum of four days of collection – three days is inadequate.

## 9.2 Determining feed intake

In most situations, feed intakes will be an important component of CH<sub>4</sub> research, and this information may be fundamental to the interpretation of results. Intake measurements are easily achieved with indoor trials, because feed offered and refused by individual animals can be measured. Even under these conditions, however, it is important that researchers are aware that at the start of a trial, the CH<sub>4</sub> is derived from material eaten previously, and the feed consumed at its conclusion is contributing CH<sub>4</sub> that will not be measured. It is therefore worthwhile measuring intakes for a few days prior to CH<sub>4</sub> measurements, especially to be sure there are no changes (most likely a decline) associated with measurements. A consistent level of intake and feed type, and a prolonged measurement period (four to five days) will improve the accuracy of any determinations. Consideration may also need to be given to rumen adaptation to dietary change, especially when the same animal is used in a crossover or Latin square design.

Intakes of grazing ruminants are difficult to estimate, and impossible to measure accurately. It is also difficult to assess the accuracy of grazing measurements. 'Obviously' incorrect intakes can be easily identified: of more concern are assumptions that most measurements are 'acceptable.'

The use of tables and equations to estimate intakes of animals in *short term* grazing trials is equally unacceptable, because daily variation in actual intakes is too great, and

a 10% overestimate of actual intakes could create a 'significant' treatment reduction in yield, when in reality, there was none.

Researchers cannot assess the accuracy of intake calculations derived from feed requirements based on changes in body weight and production. Ruminant weight is notoriously variable, because the rumen digesta accounts for 10-20% of body weight (Archer et al., 1997; Waghorn 2002) and can vary substantially within, and between, days. In addition, mobilisation and accretion of body tissue can affect feed energy associated with milk production in lactating animals, so intakes cannot be calculated from productivity alone. In beef cattle, the muscle and fat deposition rates alter during growth, so it is also hard to calculate the efficiency of feed energy use. To address these challenges, researchers must define the experimental objective carefully. Once defined, the appropriate experimental protocols can be applied.

If intake measurements are required, the experimental design must take into account the need for either 'accurate' or 'natural' (outdoor) conditions. Accuracy may be achieved by indoor feeding, but this will not be 'natural' for a grazing animal. 'Natural' may be indoor feeding in some environments, but with grazing animals, the intakes will be affected by the amount and accessibility of feed offered, weather, animal efficiency (residual feed intake), reproductive cycle (oestrus), social status in the group, effect of CH<sub>4</sub> measuring equipment and management. Furthermore, all these are affected by physiological state (Table 9.1).

When expressing CH<sub>4</sub> production in terms of intake (i.e., yield), equal value must be placed on the accuracy with which *both* measurements are made. Table 9.1 lists some positive and negative points relating to indoor feeding, grazing and calculated measurements of intake. When designing experiments intended to express CH<sub>4</sub> in terms of feed eaten, researchers must consider many factors. The points in the Table will not be expanded here, but the appropriate technique will balance the risks with the research objectives.

A realistic risk assessment must be made prior to measurements, rather than optimistically assuming the findings will be acceptable. Of most concern is the acceptance of data when it is probably flawed (e.g., estimates of intake), in order to achieve an outcome (publication), without appropriate consideration of the accuracy of the data. Unfortunately, this is too common, and has led to misleading and incorrect conclusions in CH<sub>4</sub> and all research. We reiterate: the measurements must be driven by the objective, and in some situations, intake may not be necessary when evaluating a treatment on CH<sub>4</sub> emissions: for instance, when testing mitigants of CH<sub>4</sub>, or determining emissions intensity (E<sub>i</sub>; emissions/production).

If the experimental objective is to reduce CH<sub>4</sub> emissions while maintaining production, it may be possible to simply measure CH<sub>4</sub> from farmed animals. If done over an appropriate period, without experimental bias (for example live-weight gain and loss, in dairy cows over a lactation), good information can be achieved about emissions, production and therefore, E<sub>i</sub>. This is emissions/production and, in a hungry world, may be a more sensible measure of greenhouse gas emissions than yield.



**Table 9.1: Positive and negative aspects of intake measurement from housed, grazed and estimated values.**

---

## **Indoor feeding**

### **Positives**

Accurate weights of feed offered and refused.

Accurate sampling of feed offered and refused to determine dry matter percentage and composition.

Accurate measurement of feed eaten.

Appropriate management for animals raised indoors (e.g., dairy tie-stall, free-stall).

### **Concerns**

None, if data relate to indoor management systems, and intakes are recorded accurately.

Intakes and digestion can be affected by timing/feeding frequency, even when feed is always available.

The feeding pattern will be determined by the feeding regimen.

### **Negatives**

Forage – and to a lesser extent, silage composition – changes after it is cut or removed from storage, raising the risk of heating and spoilage.

Indoor forage feeding is not representative of a grazing environment because:  
Forage is cut once or twice a day.

Forage is harvested to a predetermined height; it is often longer (and more mature) than grazed forage, to make it easier to harvest.

Intakes are likely to exceed that at grazing because of *ad libitum* availability.

Digestion will differ from grazed forage because cutting length is pre-determined and less chewing (cell damage) may be required, compared to grazed forage.

Animal selection of plant species and plant parts is limited.

Interaction with peers and time for other activities are avoided/compromised.

Hours of light/dark are altered.

## **Grazing**

### **Positives**

Grazing represents the 'real world' under which most ruminants exist in many environments and countries.

Intakes are usually limited through availability and competition with other animals.

Forage quality varies, but animals are often able to choose a variety of components in their diet.

### Concerns

Intakes vary with feed availability, competition, specific paddocks, animal management, drive to feed, etc.

Composition of diet will differ for individuals, and during the day. Under rotational grazing where new feed is given once or twice daily to achieve high forage utilisation (e.g., pasture-fed dairy cows), diet quality will diminish during the day.

In slower rotations, where animals stay in the same paddock for three to five days, the changes in forage composition, availability, and grazing behaviour are also likely to affect CH<sub>4</sub> emissions. With slow rotations, the periods of CH<sub>4</sub> measurement may be adjusted to fit the experimental objectives (e.g. three to five days in a five-day rotation).

Digestion and digestibility will be affected by diet composition, eating pattern, intake level and behaviour.

### Negatives

Intakes are usually limited through competition with other animals or availability and forage quality.

No satisfactory method for estimating feed intakes.

Pre- and post-grazing pasture cuts have moderate accuracy and can be appropriate for estimating group intakes.

Measuring faecal output (with an indigestible marker or collection bag and harness) requires knowledge of digestibility to calculate intakes, but digestibility varies substantially between individuals; values may be more defensible for groups than individuals.

Use of faecal collection bags risks losing faeces, underestimating intake and increasing estimates of CH<sub>4</sub> yield.

The alkane (plant cuticular wax) method has an advantage over external (indigestible) markers, because variation between individuals in digestibility is accounted for in the calculations. This technique is based on faecal recovery of plant waxes and a synthetic wax (usually an even chain length) administered daily to the animals. For the method to provide accurate (reliable) data, *researchers need to know the alkane content (and type) of the diet eaten, and the recovery (indigestibility) of both the plant and*

*administered alkane must be the same*, but in a mixed sward, it is not possible to determine the alkane concentration in forage eaten, because values differ between plant species, and individual animals vary in their dietary choice.

Measures of faecal recovery of alkane waxes show differences between plant and administered waxes (administered are usually higher than plant waxes).

Alkane technology is claimed to be efficacious when monocultures are grazed, but this is difficult to demonstrate.

When feed intake is estimated using external markers such as alkanes, chromium oxide and titanium dioxide, animals need to be dosed twice daily, usually for 12 days – seven days to reach steady state, followed by five days with twice-daily faecal collection. Depending on animals and circumstances, it may be best to undertake CH<sub>4</sub> and intake measurements separately; especially with animals such as sheep or beef cattle, which are unaccustomed to routine handling. However, both can be done simultaneously with dairy cows that are handled every day.

## Calculated intakes

### Positives

A value is generated, and over a period of several weeks this is likely to be a representative group mean.

### Concerns

The number may have little relevance to intakes of animals fitted with CH<sub>4</sub> sampling apparatus, especially in short term trials.

### Negatives

Feed intakes are calculated from existing tables of energy requirements, which are based on experimental data collected under situations when intakes could be measured. An average value is then derived for animals with a defined weight and productivity. Some systems (e.g., the Australian Research Council standards, 1990) take the environment into account when deriving the values, but none can take into account differences between individuals (residual feed intake, or RFI).

The energy requirements are usually based on production, live weight and live weight change, and must be measured in conjunction with CH<sub>4</sub> measurements. These data cannot be determined accurately in short-term trials, nor can the metabolisable energy content of the feed eaten.

Calculated intakes mean little in the short term, and values for young animals fitted with CH<sub>4</sub> collection apparatus will inevitably be overestimates of actual intakes. This situation would underestimate actual yields.

### 9.3 Expressing methane and measuring diet composition

When intake is measured, should CH<sub>4</sub> yield be expressed as dry matter (DM), organic matter (OM), digestible DM, or energy (gross, digestible, metabolisable or net)?

Despite current and past protocols, it is illogical to express CH<sub>4</sub> on either a gross energy (GE) or DM basis, because they do not account for variations in feed quality, nor for the source of CH<sub>4</sub>, which is digested feed. Production-targeted feeding is based on diet composition and quality, and where energy is first limiting for production, diets are assessed on the basis of available energy content for maintenance and production (metabolisable energy, or ME).

Adding fat – or reducing ash – elevates a diet's GE, and most forages have a value of about 18.4 MJ/kg DM, even though there may be a two-fold range in the feeding value for production. For example, a grain-based diet will result in much higher production, and efficiency of production (daily gain/daily feed intake) than a diet of fibrous forages. Historically, CH<sub>4</sub> has been expressed on a GE basis, and more recently on a DM basis, for inventory. Expression on a DM basis may be justified if feed requirements have been based on DM requirements, but in reality, this is dated and inappropriate. Expressing CH<sub>4</sub> emission based on gross feed intake may be acceptable for emissions inventory purposes, but mitigation research needs to be evaluated on a more meaningful basis.

Expression in terms of organic matter is logical, because the CH<sub>4</sub> does not originate from the ash component of feed. However, it is not much more useful than DM, especially as ash accounts for between 7 and 10% of DM in most feedstuffs. When energy is first limiting for production – as with good quality temperate pasture species – it would be sensible to express CH<sub>4</sub> in terms of ME, because this is the basis of determining either the feed required to achieve a predetermined level of production, or predicting the production likely from a set ME intake.

So, ME may appear a logical way to express CH<sub>4</sub> emissions, but a feed's ME varies with intake, and the efficiency of use for production is affected by diet composition (Waghorn, 2007). ME is not a constant, and is usually predicted rather than measured.

There is some logic in expressing CH<sub>4</sub> on the basis of material digested, but only ruminal and hind-gut digestion contributes CH<sub>4</sub>. Digestibility varies with intake, feed type and individual animal, and some reports have suggested a poor relationship between CH<sub>4</sub> yield and digestibility (Johnson and Johnson, 1995; Hammond et al, 2013).

These variables highlight some of the factors that should be considered when designing an experiment, but there is no right or wrong method of expression. The important thing is that measurements of feed intake and feed composition are accurate and repeatable.

One of the most difficult – though often unrecognised – challenges faced by researchers is measuring forage DM content and composition, especially of wet

forages fed indoors. This could be illustrated by a feeding trial with cattle in a barn situation, where 5 t of wet pasture is offered daily, but less than 2 kg might be used to determine the DM percentage of material offered, and less than a gram is used for analysis. The problem is greater still with very moist forages, and is made worse when the material contains a range of plant species. For example, if the feed offered is about 12% DM, then an error of  $\pm 0.5$  of a percentage unit (11.5 to 12.5% DM) represents an 8.3% variation in feed offered.

Errors in feed DM determination can be minimised by taking several samples, then drying 'representative' samples (200 g wet weight) when new feed is given, and in triplicate. It is important that samples represent the material offered, and that they do not dry out prior to oven drying. They should be placed in a plastic bag, held at 4°C, and when removed for drying, sub-sampling and weighing, this should be done quickly.

The problem is less important with refusals (orts), especially if these represent 10-15% of material offered, because the error can only be 10-15% of that associated with the feed offered. Sampling for analysis represents another challenge, and sometimes grinding a large, rather than small, sample will lessen errors associated with sub-sampling. When material is ground in a Wiley mill, there is always some residue remaining in the mill. This is inevitably stalky material, so grinding in effect lowers the fibre content of the sample submitted for analysis. Some labs do not clean the mill between grinding samples of similar material, in an effort to maintain representative material.

The assays themselves are really the prerogative of the researcher, and may be based on wet chemistry or near infrared spectroscopy (NIRS), but it is imperative that all samples are prepared in accordance with analytical requirements. Samples used for DM determination (e.g., dried at 105°C for 24h) will not be suitable for chemical analyses. It is helpful to keep a spare sample (in the dark) so additional analyses can be carried out, if needed.

## 9.4 References

Archer, J.A, Arthur, R.F, Herd, R.M, Parnell, P.F, & Pitchford, W.S, 1997. Optimum post-weaning test for measurement of growth rate, feed intake and feed efficiency in British breed cattle. *J. Anim. Sci.* 75, 2024-2032.

Australian Agricultural Council 1990. Feeding standards for Australian livestock - Ruminants. CSIRO Publications, Sydney, Australia.

Hammond, K.J, Muetzel, S, Waghorn, G.C, Pinares-patino, C.S, Burke, J.L & Hoskin, S.O, 2009. The variation in methane emissions from sheep and cattle is not explained by the chemical composition of ryegrass. *Proceedings of the New Zealand Society of Animal Production*: 69 174-178.

Hammond, K.J, Hoskin, S.O, Burke, J.L, Waghorn, G.C, Koolard, J.P & Muetzel S, 2011. Effect of feeding fresh white clover (*Trifolium repens*) or perennial ryegrass (*Lolium*

*perenne*) on enteric methane emissions from sheep. *Anim. Feed Sci. Tech.* 166-167: 398-404.

Hammond, K.J, Burke, J.L, Koolaard, J.P, Muetzel, S, Pinares-Patiño, C.S & Waghorn, G.C, 2013. The effect of feed intake on enteric methane emissions from sheep fed fresh white clover (*Trifolium repens*) and perennial ryegrass (*Lolium perenne*) forages. *Anim. Feed Sci. Tech.* 179; 121-132.

Johnson, K.A & Johnson, D.E, 1995. Methane emissions from cattle. *J. Anim. Sci.* 73, 2483-2492.

Grainger, C, Clarke, T, McGinn, S.M, Auldish M.J, Beauchemin, K.A, Hannah, M.C, Waghorn, G.C, Clark H & Eckard, R.J 2007. Methane emissions from dairy cows measured using the sulfur hexafluoride (SF<sub>6</sub>) tracer and chamber techniques. *J. Dairy Sci.* 90, 2755-2766.

McGinn, S.M, Beauchemin, K.A, Iwaasa, A.D & McAllister, T.A 2006. Assessment of the sulfur hexafluoride (SF<sub>6</sub>) tracer technique for measuring enteric methane emissions from cattle. *J. Environ. Quality* 35, 1686-1691.

Münoz, C, Yan, T, Will, D.A, Murray, S & Gordon, A.W, 2012. Comparison of the sulphur hexafluoride tracer and respiration chamber techniques for estimating methane emissions and correction for rectum methane output from dairy cows. *J. Dairy Sci.* 95, 3139-3148.

Sun, X.Z, Hoskin, S.O, Muetzel S, Molano, G & Clark, H, 2011. Effect of chicory (*Cichorium intybus*) and perennial ryegrass (*Lolium perenne*) on methane emissions *in vitro* and from sheep. *Anim. Feed Sci. Tech.* 166-167, 391-397

Vlaming, J, Clark, H, & Lopez-Villalobos, N, 2005. The effect of SF<sub>6</sub> release rate, animal species and feeding conditions on estimates of methane emissions from ruminants. *Proceedings of the New Zealand Society of Animal Production* 65, 4-8.

Vlaming, J, Brookes, I, Hoskin, S, Pinares-Patino, C & Clark, H, 2007. The possible influence of intra-ruminal sulphur hexafluoride release rates on calculated CH<sub>4</sub> emissions from cattle. *Can. J. Anim. Sci.* 87, 269-275.

Waghorn, GC, 2002. Can forages match concentrate diets for dairy production? *Proceedings of the New Zealand Society of Animal Production* 62, 261-266.

Waghorn, GC, 2007. What is metabolisable energy? *Proceedings of the New Zealand Grassland Association* 69, 153-169.

## 10 ESTIMATING METHANE EMISSION RATES AND METHANE YIELD USING THE SF<sub>6</sub> TECHNIQUE

P.J. Moate<sup>a\*</sup>, S.R.O. Williams<sup>a</sup>, M.H. Deighton<sup>a</sup>, C. Pinares-Patiño<sup>b</sup> & K.R. Lassey<sup>c</sup>

<sup>a</sup>Department of Environment and Primary Industries (DEPI), Ellinbank, Victoria, Australia

<sup>b</sup>AgResearch Limited, Palmerston North, New Zealand

<sup>c</sup>Lassey Research & Education Ltd, Lower Hutt, New Zealand

\*Corresponding Author: P.J Moate; [peter.moate@depi.vic.gov.au](mailto:peter.moate@depi.vic.gov.au)

---

### 10.1 Basic theory

The sulphur hexafluoride (SF<sub>6</sub>) tracer technique developed by Zimmerman (1993) has become a popular method for measuring ruminant methane (CH<sub>4</sub>) emissions. Chapter 13 contains a comprehensive list of publications that reported either on the development of the SF<sub>6</sub> technique, or on its use.

The technique – first used in ruminant nutrition research by Johnson et al. (1994) – relies on a permeation tube to release a small amount of SF<sub>6</sub> at a known and constant rate into the rumen. The released SF<sub>6</sub> mixes with rumen fermentation gas, and acts as a tracer for rumen CH<sub>4</sub>. The SF<sub>6</sub> technique is based on a breath sampling and collection system mounted on a head-harness attached to the animal. The system involves an evacuated container that draws air from near the nose and mouth through a tube.

The air flow rate is limited by means of a flow restrictor, such as a capillary tube. In the method as described by Johnson et al. (1994), the known daily release rate ( $Q_{SF_6}$ , mole/d) of SF<sub>6</sub> from the permeation tube and the ratio of the 'mixing ratios' (sometimes designated as concentrations) of CH<sub>4</sub> and SF<sub>6</sub> in the collected gas sample were used to estimate the daily rate of CH<sub>4</sub> emissions ( $Q_{CH_4}$ , mole/animal/d) as described by Eqn 10.1:

$$Q_{CH_4} = Q_{SF_6} \frac{[CH_4]}{[SF_6]} \quad \text{Eqn 10.1}$$



Note: in Eqn 10.1, the mixing ratios of SF<sub>6</sub> and CH<sub>4</sub> must be expressed in the same units; for example, parts per trillion, and  $Q_{SF_6}$  and  $Q_{CH_4}$  in the same consistent units; for example, mol/d.

When the SF<sub>6</sub> technique is used to estimate CH<sub>4</sub> emissions, the most important equation that should underlie all considerations is the ideal gas law, as shown in Eqn 10.2:

$$PV = nRT \qquad \text{Eqn 10. 2}$$

Here,  $P$  is the gas pressure (atm),  $V$  is the volume of a gas (L),  $n$  is the number of moles of the gas,  $R$  is the ideal gas constant (0.08206, L.atm.deg<sup>-1</sup>.mole<sup>-1</sup>) and  $T$  is temperature in degrees Kelvin. Thus, the correct, consistent units appropriate to each situation must be used. Mixing ratios are defined as mole fractions of the gas concerned in dry (or dried) air. But, as can be deduced from Eqn 10.2, at a given temperature and pressure, the partial volume of a gas in a mixture of gases is proportional to the number of moles of that gas in the sample. Hence, in equations involving mixing ratios, it is appropriate and convenient to think of them in terms of volume ratios, provided that the ideal gas law applies under the prevailing conditions.

However, the law breaks down at high pressures when a molecular volume is a significant fraction of the total occupied volume per molecule. In this context, a part per million or billion or trillion can be equated to a volume fraction. Accordingly, 1 ppm (or 1 ppt) of trace gas – defined rigorously as 1 μmol/mol (or 1 pmol/mol) – is sometimes written as 1 ppmv (or 1 pptv), or one unit volume of trace gas in 10<sup>6</sup> (or 10<sup>12</sup>) volumes of dried air.

The SF<sub>6</sub> technique has evolved from that succinctly described by Johnson et al. (1994), and it has recently been used in many countries, including Australia (Grainger et al., 2007; 2008), Brazil (Pedreira et al., 2009), Canada (McGinn et al., 2006; Holtshausen et al., 2009), France (Pinares-Patiño et al., 2007; Morgavi et al., 2008), Ireland (Wims et al., 2010) and New Zealand (Vlaming et al. 2007, 2008; Ramirez-Restrepo et al., 2010; Pinares-Patiño et al., 2011). Lassey et al. (1997) described the technique in more detail than Johnston et al. (1994), being apparently the first authors to explicitly state that the CH<sub>4</sub> emission calculation should use the concentrations of SF<sub>6</sub> and CH<sub>4</sub> “in excess of background”. The intent of this correction procedure is stated explicitly in Eqn 10.3, where the  $M$  subscript indicates the gas mixing ratio measured in a breath sample, and a  $BG$  subscript indicates the same in a background sample:

$$R_{CH_4} = R_{SF_6} \frac{[CH_4]_M - [CH_4]_{BG}}{[SF_6]_M - [SF_6]_{BG}} \cdot \frac{MW_{CH_4}}{MW_{SF_6}} \cdot 1000 \quad \text{Eqn 10.3}$$

In Eqn 10.3,  $R_{CH_4}$  is the calculated production rate of enteric CH<sub>4</sub> (g/animal/d),  $R_{SF_6}$  is the measured release rate of SF<sub>6</sub> from the permeation tube (mg/d),  $MW_{CH_4}$  is the molecular mass of CH<sub>4</sub> (16), and  $MW_{SF_6}$  is the molecular mass of SF<sub>6</sub> (146). For convenience, the mixing ratio of CH<sub>4</sub> is generally expressed in ppm, and that of SF<sub>6</sub> in ppt. This is the case in Eqn 10.3. The factor of 1000 in Eqn 10.3 is a unit converter, taking into account the disparate units for [SF<sub>6</sub>] in ppt, [CH<sub>4</sub>] in ppm, and  $R_{SF_6}$  in (mg/d), so that  $R_{CH_4}$  will have the desired units of g/d.

Since the work of Johnson et al. (1994) and Lassey et al. (1997), there have been more than 50 scientific publications that explicitly report that background corrections shown in Eqn 10.3 were used to calculate CH<sub>4</sub> emissions (For example, Boadi et al., 2002; Grainger et al., 2008, 2010; Pinares-Patino et al., 2007; Vlaming et al. 2007, 2008).

Despite the now widespread use of background correction in the SF<sub>6</sub> technique, there are at least three scientific articles that have not explicitly reported making background corrections, and one article where background correction was made only for CH<sub>4</sub>. Recently, Williams et al. (2011) researched and reviewed issues associated with background corrections and their impact on CH<sub>4</sub> emissions as calculated by the SF<sub>6</sub> technique, and Lassey (2013) has illustrated how ill-considered backgrounds can mislead experimental findings (see Chapter 7).

## 10.2 Choice of Breath Sample Integration Period

Almost all implementations of the SF<sub>6</sub> tracer technique have used 24-hour breath collections, thereby estimating emission rates averaged over 24 hours. Given that one might expect SF<sub>6</sub> to be emitted at near equal measure every eructation cycle – whereas CH<sub>4</sub> emission patterns are strongly correlated with feeding patterns – it makes sense to consider only average emissions of those gases over a full feeding cycle, or multiples thereof. Martin et al. (2008) accumulated breath samples for only eight hours, which included a single meal. They also sampled rumen headspace gas throughout the same eight hours. Their emission estimates were then necessarily averaged over only eight hours, and should not be compared with daily averages, unless a similar meal is offered and eaten every eight hours.

Taking it to the extreme, Hristov et al. (2009), in a novel variant of the SF<sub>6</sub> technique, used a syringe to collect spot samples of rumen headspace gas hourly, from two hours after the morning feeding, until six hours post-feeding. Upon extrapolating data for their control diet on the basis of equal meals every six hours daily, emissions would be estimated at 156 g CH<sub>4</sub>/d, corresponding to a surprisingly small CH<sub>4</sub> yield of 5.9 g CH<sub>4</sub>/kg DMI. This illustrates the danger in extrapolating short-term measurements to a full 24-hour feeding cycle.

Bárbaro et al. (2008) have experimented with multi-day sampling, which suits the Argentinian beef system in which animals roam freely without mustering for several days. In general, fair agreement was obtained when an Argentine multi-day collection system was compared with a typical New Zealand 24-hour collection system (Pinares-Patiño, 2012).

The above variations on daily breath collection were motivated by constraints on the experimental protocol. In a separate study, Lassey et al. (2011) examined the role of breath collection duration, called “averaging period”, in a purpose-designed experiment. This experiment departed from the standard breath collection approach by pumping breath samples directly into Tedlar bags. A continuous flow of breath sample from each of nine sheep (three groups of three) for six days was diverted into a clean bag every 20 minutes. Two bags were associated with each sheep, and while one was being filled, the other was analysed automatically, the residue discarded and the bag readied for reuse. This provided a pattern of CH<sub>4</sub> and SF<sub>6</sub> emissions averaged every 20 minutes for six days. Data could be aggregated to mimic averaging periods of any multiple of 20 minutes.

A surprising finding in the experiment of Lassey et al. (2011) was that, not only was SF<sub>6</sub> not emitted at a uniform rate throughout the day, but that its emission pattern strongly correlated with the CH<sub>4</sub> emission pattern ( $R^2 = 0.732$  among 3820, 20-min samples).

This finding may be disconcerting, because the mechanism is undetermined, but such a correlation actually improves the merit of SF<sub>6</sub> as a tracer of enteric CH<sub>4</sub>. It may also partially contribute to the SF<sub>6</sub> technique’s apparent innate variability, which has been reported by some researchers (see “Uncertainty” below). The experiment of Lassey et al. (2011) confirmed that emission rate estimates made with multi-day averaging periods agreed with daily estimates, as did estimates based on 12-hour averaging periods, and often also on six-hour and three-hour averaging periods.

### 10.3 Uncertainty and variability in CH<sub>4</sub> emissions estimates

Estimates of CH<sub>4</sub> emissions using the SF<sub>6</sub> tracer technique are associated with larger between- and within-animal variability than measurements from respiration chambers. Variability associated with the tracer technique could be due to many factors, and we speculate these could include differences between CH<sub>4</sub> and SF<sub>6</sub> dynamics within the digestive tract, differences in excretion pathways, fluctuations in SF<sub>6</sub> permeation rate from its host tube and lastly – but perhaps most importantly – poor implementation of the SF<sub>6</sub> technique, and/or the fact that it can be inherently difficult to accurately measure SF<sub>6</sub> concentrations in air in the ppt range.

The magnitude of CH<sub>4</sub> emissions from ruminants varies principally in direct relation to the dry matter intake. Many researchers using calorimeters and chambers have shown that CH<sub>4</sub> yields are approximately 23 g CH<sub>4</sub> /kg DMI (Dijkstra et al. 2011). It would seem reasonable, therefore, that CH<sub>4</sub> yields estimated by the SF<sub>6</sub> technique should also be approximately 23 g CH<sub>4</sub>/kg DMI. Except in circumstances where extreme

dietary manipulations or dietary supplements are concerned, CH<sub>4</sub> yields outside of the range 17 – 29 g CH<sub>4</sub>/kg DMI should probably be regarded with suspicion.

When researchers employ the SF<sub>6</sub> technique, very low and very high estimates of CH<sub>4</sub> emissions may sometimes be encountered, and some researchers routinely remove these 'outlier' estimates. Criteria or protocols for rejection of outlier estimates (pertaining to CH<sub>4</sub> emissions as measured by the SF<sub>6</sub> technique) have not been widely discussed in the scientific literature, nor has any consensus been reached.

Therefore, it seems likely that different researchers may have employed different protocols or criteria for eliminating outlier estimates, and this may have contributed to some of the inter-experiment differences in mean CH<sub>4</sub> yields reported in the scientific literature. For now, we recommend that researchers use the outlier elimination procedure described in Chapter 11.

## 10.4 Metric of measurement

Methane emissions from ruminants can be expressed in several ways. An amount of CH<sub>4</sub> is best described by its mass in grams or kilograms. In practice, when using the SF<sub>6</sub> technique to estimate CH<sub>4</sub> emissions, an amount of CH<sub>4</sub> can best be described by its weight in grams. The molar mass of CH<sub>4</sub> is 16.042 g/mole. From the ideal gas law (Eqn 10.2), it can be calculated that, at standard temperature and pressure (STP: 273.2°K, i.e., 0°C and pressure 1.0 atmosphere), one mole of CH<sub>4</sub> has a volume given by:

$$V = \frac{nRT}{P} = \frac{1 * 0.08205 * 273.2}{1} = 22.416L \quad \text{Eqn 10. 4}$$

But experiments are not usually conducted at STP. For this reason, we recommend that researchers follow the accepted convention amongst authors publishing on ruminant CH<sub>4</sub> emissions, and report them in units of (g CH<sub>4</sub>/d). This allows readers to easily compare emissions between different studies, without the need to correct for differences in temperature or pressure at the different experiment locations.

Another fundamental metric that authors should report is CH<sub>4</sub> yield, and the recommended unit is: g CH<sub>4</sub>/kg DMI. Although other measures of food intake can be used, dry matter intake should always be included, as it is the most common and easily determined measurement of feed intake. It is very important that a measurement of emissions per unit of intake is included in published literature, because of the high correlation between feed intake and enteric CH<sub>4</sub> emissions. Publications that omit an intake metric deny their readers the opportunity to assess the relative emissions reported, as it is impossible to determine if the scale of emissions reported is due to an experimental condition, or simply the animal's level of feed intake.

Depending upon the subject being researched, or the industry context, other metrics may also be appropriate. These metrics, which bear a generic name of CH<sub>4</sub> intensity, include: emissions relative to bodyweight change (g CH<sub>4</sub>/kg ΔBWT); emissions relative to milk production (g CH<sub>4</sub>/L milk) and emissions relative to production of milk solids (g CH<sub>4</sub>/kg MS).

## 10.5 References

Bárbaro, N, Gere, J, Gratton, R, Rubio, R & Williams, K, 2008. First measurements of methane emitted by grazing cattle of the Argentinean beef system. *NZ. J. Agric. Res.* 51, 209-219.

Boadi, D.A & Wittenberg, K.M, 2002. Methane production from dairy and beef heifers fed forages differing in nutrient density using the sulfur hexafluoride (SF<sub>6</sub>) tracer gas technique. *Can. J. Anim. Sci.* 82, 201-206.

Dijkstra, J, van Zijderveld, S.M, Apajalahti, J.A, Bannink, A, Gerrits, W.J.J, Newbold, J.R, Perdok, H.B & Berends, H. 2011. Relationships between methane production and milk fatty acid profiles in dairy cattle. *Anim. Feed Sci. Tech.* 166-167, 590-595.

Grainger, C, Clarke, T, McGinn, S.M, Auldist, M.J, Beauchemin, K.A, Hannah, M.C, Waghorn, G.C, Clark, H & Eckard, R.J, 2007. Methane emissions from dairy cows measured using the sulfur hexafluoride (SF<sub>6</sub>) tracer and chamber techniques. *J. Dairy Sci.* 90, 2755-2766.

Grainger, C, Auldist, M.J, Clarke, T, Beauchemin, K.A, McGinn, S.M, Hannah, M.C, Eckard, R.J, Lowe, L.B, 2008. Use of monensin controlled-release capsules to reduce methane emissions and improve milk production of dairy cows offered pasture supplemented with grain. *J. Dairy Sci.* 91, 1159-1165.

Grainger, C, Williams, R, Clarke, T, Wright, A-D.G & Eckard, R.J, 2010. Supplementation with whole cottonseed causes long-term reduction of methane emissions from lactating dairy cows offered a forage and cereal grain diet. *J. Dairy Sci.* 93, 2612-2619.

Holtshausen, L, Chaves, A.V, Beauchemin, K.A, McGinn, S.M, McAllister, T.A, Odongo, N.E, Cheeke, P.R, & Benchaar, C. 2009. Feeding saponin-containing *Yucca schidigera* and *Quillaja saponaria* to decrease enteric methane production in dairy cows. *J. Dairy Sci.* 92, 2809-2821.

Hristov, A.N, Vander Pol, M, Agle, M, Zaman, S, Schneider, C, Ndegwa, P, Vadella, V.K, Johnson, K, Shingfield, K.J, & Karnati, S. K. R. 2009. Effect of lauric acid and coconut oil on ruminal fermentation, digestion, ammonia losses from manure, and milk fatty acid composition in lactating cows. *J. Dairy Sci.* 92, 5561-5582.

Johnson, K, Huyler, M, Westberg, H, Lamb, B, Zimmerman, P, 1994. Measurement of methane emissions from ruminant livestock using a SF<sub>6</sub> tracer technique. *Environ. Sci. Tech.* 28, 359-362.

Lassey, K.R, 2013. On the importance of background sampling in applications of the SF<sub>6</sub> tracer technique to determine ruminant methane emissions. *Anim. Feed Sci. Tech.* 180, 115-120.

Lassey, K.R, Ulyatt, M.J, Martin, R.J, Walker, C.F & Shelton, I.D, 1997. Methane emissions measured directly from grazing livestock in New Zealand. *Atmos. Environ.* 31, 2905-2914.

Lassey, K.R, Pinares-Patiño, C.S, Martin, R.J, Molano, G & McMillan, A.M.S. 2011. Enteric methane emission rates determined by the SF<sub>6</sub> tracer technique: Temporal patterns and averaging periods. *Anim. Feed Sci. Tech.* 166=167, 183=191. doi:10.1016/j.anifeedsci.2011.04.066

Martin, C, Rouel, J, Jouany, J.P, Doreau, M & Chilliard, Y. 2008. Methane output and diet digestibility in response to feeding dairy cows crude linseed, extruded linseed, or linseed oil. *J. Anim. Sci.* 86, 2642-2650.

McGinn, S.M, Beauchemin, K.A, Iwaasa, A.D & McAllister, T.A, 2006. Assessment of the sulfur hexafluoride (SF<sub>6</sub>) tracer technique for measuring enteric methane emissions from cattle. *J. Environ. Qual.* 35, 1686-1691.

Morgavi, D.P, Jouany, J.P & Martin, C, 2008. Changes in methane emission and rumen fermentation parameters induced by refaunation in sheep. *Aust. J. Exp. Agric.* 48, 69-72.

Pedreira, M.d.S, Primavesi, O, Lima, M.A, Frighetto, R, de Oliveira, S. G & Berchielli, T.T, 2009. Ruminant methane emission by dairy cattle in southeast Brazil. *Sci. Agric.* 66, 742-750.

Pinares-Patiño, C.S, Gere, J, Williams, K, Gratton, R, Juliarena, P, Molano, G, MacLean, S, Sandoval, E, Taylor, G & Koolard, J. 2012. Extending the collection duration of breath samples for enteric methane emission using the SF<sub>6</sub> tracer technique. *Animal* 2, 275-287; doi:10.3390/ani2020275.

Pinares-Patiño, C.S, D'Hour, P, Jouany, J.P & Martin, C, 2007. Effects of stocking rate on methane and carbon dioxide emissions from grazing cattle. *Agric. Ecosyst. Environ.* 121, 30-46.

Pinares-Patiño, C.S, Lassey, K.R, Martin, R.J, Molano, G, Fernandez, M, MacLean, S, Sandoval, E, Luo, D & Clark, H, 2011. Assessment of the sulfur hexafluoride (SF<sub>6</sub>) tracer technique using respiratory chambers for estimation of methane emissions from sheep. *Anim. Feed Sci. Tech.*, 166-167, 201-209, doi:10.1016/j.anifeedsci.2011.04.067.

Ramirez-Restrepo, C.A, Barry, T.N, Marriner, A, Lopez-Villalobos, N, McWilliam, E.L, Lassey, K.R & Clark, H, 2010. Effects of grazing willow fodder blocks upon methane production and blood composition in young sheep. *Anim. Feed Sci. Tech.* 155, 33-43.

Vlaming, J.B, Brookes, I.M, Hosking, S.O, Pinares-Patiño, C.S & Clark, H, 2007. The possible influence of intra-ruminal sulphur hexafluoride release rates on calculated methane emissions from cattle. *Can. J. Anim. Sci.* 87, 269-275.

Vlaming, J.B, Lopez-Villalobos, N, Brookes, I.M, Hoskin, S.O & Clark, H, 2008. Within- and between-animal variance in methane emissions in non-lactating dairy cows. *Aust. J. Exp. Agric.* 48, 124-127.

Williams, S.R.O, Moate, P.J, Hannah, M.C, Ribaux, B.E & Eckard, R.J. 2011. Background matters with the SF<sub>6</sub> tracer method for measuring enteric methane emissions from dairy cows. *Anim. Feed Sci. Tech.* 170, 265-276. doi:10.1016/j.anifeesci.2011.08.103.

Wims, C, Deighton, M, Lewis, E, O'Loughlin, B, Delaby, L, Boland, T.M. & O'Donovan, M. 2010. Effect of pre-grazing herbage mass on methane production, dry matter intake and milk production of grazing dairy cows during the mid season period. *J. Dairy Sci.* 93: 4976-4985.

Zimmerman, P, U.S. Patent 5265618, "System for Measuring Metabolic Gas Emissions from Animals," U.S. Patent and Trademark Office, November 30, 1993.



## 11 DATA QUALITY ASSURANCE AND QUALITY CONTROL

C. Pinares-Patiño<sup>a\*</sup>, S.R.O. Williams<sup>b</sup>, C. Martin<sup>cd</sup>, N.M. Swainson, A. Berndt<sup>e</sup>, G. Molano<sup>a</sup> & J.P. Koolgaard<sup>a</sup>

<sup>a</sup>AgResearch Limited, Palmerston North, New Zealand

<sup>b</sup>Department of Environment and Primary Industries, Ellinbank, Victoria, Australia

<sup>c</sup>INRA, UMR1213 Herbivores, Saint-Genès-Champanelle, France;

<sup>d</sup>Clermont Université, VetAgro Sup, UMR1213 Herbivores, Clermont-Ferrand, France

<sup>e</sup>Embrapa, Fazenda Canchim, São Carlos, SP - Brasil

\*Corresponding Author: C. Pinares-Patiño; [cesar.pinares@agresearch.co.nz](mailto:cesar.pinares@agresearch.co.nz)

---

'Quality assurance' implies that a level of desired experimental quality is maintained throughout when estimating emissions of methane (CH<sub>4</sub>) using the SF<sub>6</sub> tracer technique. In other words, that all actions are unbiased, and that the animals respond in a 'normal' manner to the experimental conditions. 'Quality control' involves steps and protocols, closely followed, to ensure that experimental results are valid, thereby assuring data quality. This chapter highlights some issues encountered when using the SF<sub>6</sub> tracer technique for estimating CH<sub>4</sub> emissions from ruminants, both indoors and under free-ranging situations. It briefly addresses problems associated with permeation tube calibration and expected *in situ* release of the SF<sub>6</sub> (see Chapter 4 for more details), efficiency of sample collection and anomalies of unknown origin. It also suggests steps for data screening for outliers. Here, we refrain from addressing issues related to sample analysis for concentrations of CH<sub>4</sub> and SF<sub>6</sub> (see Chapter 8).

### 11.1 Problems with calibrated permeation rates of SF<sub>6</sub> and range of permeation rates

Permeation tubes have no standard rate of SF<sub>6</sub> release. Therefore, each tube should be calibrated for 8 to 12 weeks after filling. The rate of mass loss during the first two weeks is generally ignored when calculating SF<sub>6</sub> permeation rate (PR). Only those tubes with a steady rate of mass loss ( $R^2 > 0.99$ ) should be considered for selection as a tracer source. It is advised that in any single trial, only tubes within a narrow range of permeation rate (PR) – about 10% difference between the low and high PR – should be used, and PR balanced across treatments, as there is a suggestion that CH<sub>4</sub> emission

estimation may be positively associated with PR (Pinares-Patiño and Clark, 2008; Martin et al., 2012). Nevertheless, causes other than PR for this inferred association cannot be ruled out (Lassey, 2013).

It remains debateable which permeation tubes – those with low or high PR of SF<sub>6</sub> – are the more accurate for estimating CH<sub>4</sub> emissions (Pinares-Patiño and Clark, 2008), especially when plausible CH<sub>4</sub> emission estimates can be obtained using tubes with PR two orders of magnitude higher than usual (Hegarty et al., 2007). Furthermore, given that the release rate of SF<sub>6</sub> from permeation tubes diverges from the pre-determined permeation rate over time (Pinares-Patiño, 2000; Lassey et al., 2001; Swainson, 2011), it is advised that when no allowance is made for this change, animal trials should be conducted no later than three to four months after tube insertion. When experiments need to be conducted over longer periods, some cohort permeation tubes should be maintained in the lab, and their PR monitored so the *in situ* PR can be adjusted using the change in PR of these surveillance tubes (Lassey et al., 2001).

Rochette et al. (2012) have suggested that it is better to calibrate permeation tubes after exposure to the rumen environment, rather than use dry *in vitro* calibration, as commonly practiced. However, recent observations (Deighton et al., 2013) suggest that any change in PR of SF<sub>6</sub> may be due to exposure of the Teflon membrane to SF<sub>6</sub>, rather than exposure to the rumen environment.

## 11.2 Background concentrations of tracer and trace gases

The SF<sub>6</sub> gas is the tracer of choice for estimating CH<sub>4</sub> emissions from ruminants (Chapter 2). This is due to its detectability at very low concentrations (~1 ppt), reasonable assumptions of predictable SF<sub>6</sub> permeation rate from permeation tubes deployed in the reticulo-rumen and its likely inertness and non-toxicity to the ruminal microbiota and host – and consequently the safety of animal products. However, one major requirement for any tracer gas is that concentrations in the environment (atmosphere) should be very low, relative to concentration of the tracer in collected samples. Concentrations of SF<sub>6</sub> in the animal local environment can vary, and if local background concentrations are not accounted for, there is a risk of biasing the calculated CH<sub>4</sub> emission.

Signal-to-noise ratio (SNR) can be used as a threshold for the acceptance of results. In SF<sub>6</sub> techniques, the desired 'signal' is the gas concentration in the animal breath sample, and the 'noise' is the background gas concentration. Some laboratories use a SNR of 10 as a threshold for acceptance of results. Consequently, these laboratories discard results from breath samples when the background concentration of SF<sub>6</sub> is > 10% of the SF<sub>6</sub> concentration in the breath sample (Figure 11.1). Nevertheless, experimental planning should ensure that background concentrations of SF<sub>6</sub> do not exceed 10 ppt. Measures include appropriate ventilation (especially indoors) and isolation of known non-experimental sources of SF<sub>6</sub>.

The atmospheric concentration of the SF<sub>6</sub> gas is steadily increasing at about 0.22 ppt/yr, and global mean concentration in year 2010 was around 7 ppt, being higher in

the northern hemisphere than the southern (Hall et al., 2011). Local SF<sub>6</sub> concentrations can be affected by leaks from the electricity network, and it has been reported that SF<sub>6</sub> can be transported long distances by the wind (K.R. Lassey, personal communication). Similarly, local CH<sub>4</sub> concentrations can be affected by neighbouring animals, slurry tanks and effluent ponds.

It is possible to minimise local background concentrations of SF<sub>6</sub> and CH<sub>4</sub>. Outdoor experiments should be conducted away from known non-experimental sources, and if possible, upwind of those sources. Researchers at the Department of Environment and Primary Industries, Victoria, Australia have observed higher concentrations of SF<sub>6</sub> in background samples when the wind is blowing from an electricity generation plant 40 km away than when blowing from other directions (Unpublished data). Indoor experiments need to make careful consideration of where background gas samples are collected. There is evidence that indoor concentrations of SF<sub>6</sub> may change with individual stall location, point within a feeding bin and/or height in relation to the floor (Williams et al., 2011). Sentinel background samplers would allow different background compositions to be associated with different animal locations within the housing environment (Williams et al., 2011). The locations of background samplers can crucially impact on research findings, and reports of a possible dependence of estimated CH<sub>4</sub> emission rates upon the pre-calibrated rate of SF<sub>6</sub> release (Pinares-Patiño and Clark, 2008) may be due to the measured background of SF<sub>6</sub> and/or CH<sub>4</sub> poorly representing the actual background air available to the animals (Lassey, 2013).

It is advised that before commencing an experiment, the background concentrations of SF<sub>6</sub> should be measured, preferably during two to three days). The same applies for CH<sub>4</sub> background. Whenever possible, experiments should be located away from non-experimental sources of CH<sub>4</sub> (animals, slurry tanks, ponds, etc) and SF<sub>6</sub> (electricity transformers, etc.).

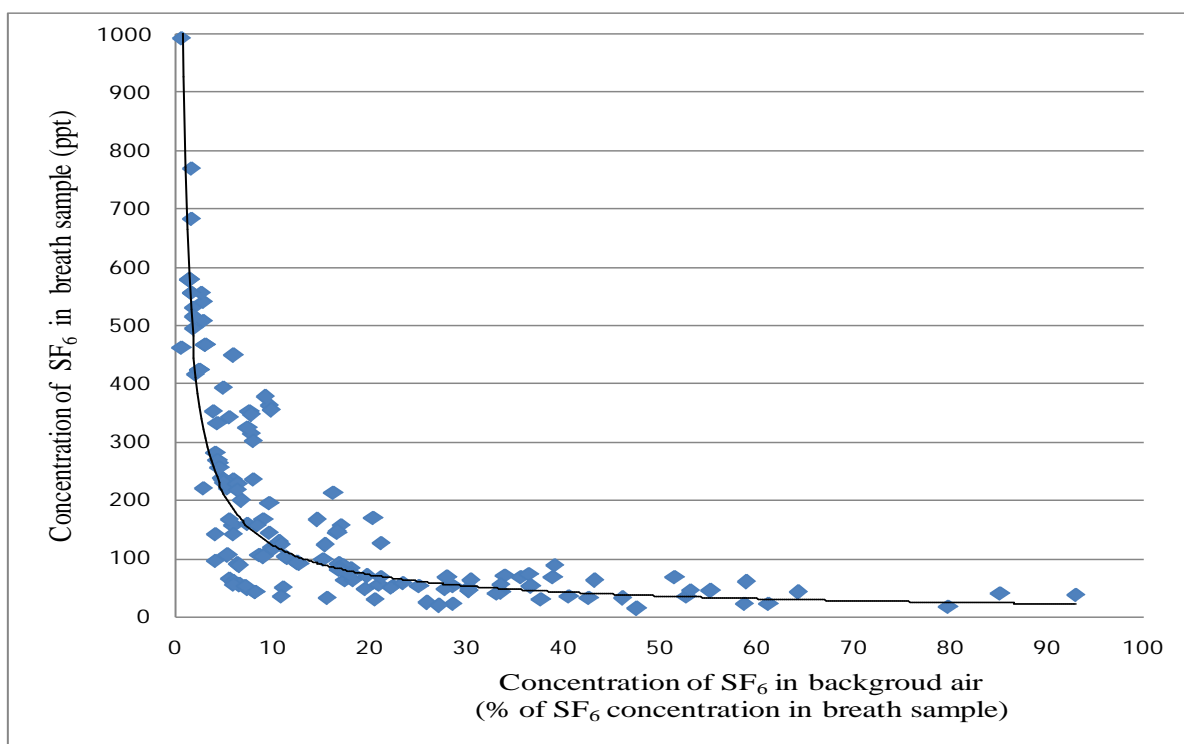

Figure 11.1: Concentrations of SF<sub>6</sub> in breath sample and in the background air (expressed as a percentage of the concentration in breath) found during an experiment at INRA Clermont-Ferrand (France) (Yvonne Rochette, unpublished data).

*Overestimated CH<sub>4</sub> emission values will arise from increased concentrations of SF<sub>6</sub> in the background as well as highly diluted concentrations of SF<sub>6</sub> in the breath sample. Ideally, background concentrations of SF<sub>6</sub> should be <10 ppt and <10% of the concentrations in the breath sample.*

When animals are grazing, it is often recommended that background air samples are obtained upwind of fixed points outside the animal enclosure (grazing area). However, there are two potential problems with this: first, the prevailing wind direction may change between and within days; second, fixed background sampling points do not reflect the background concentrations to which the experimental animals are exposed. Animals are highly interactive with their peers and some species, such as sheep, are highly gregarious.

One way to overcome these issues is to use four background air samplers spaced evenly around the group and use the average. An alternative is to incorporate animals as 'mobile' background samplers when using a tracer technique. This is achieved by having at least two animals per treatment, which are dosed with permeation tubes of mean release rate and samples collected using inlets located away from the mouth and nostrils. These animals can provide near-real information on background concentrations of both CH<sub>4</sub> and SF<sub>6</sub>.

For example, a recent grazing experiment in New Zealand with 30 cattle (Cesar Pinares-Patiño, unpublished data) found that samples collected from mobile samplers (two steers) had systematically higher concentrations of SF<sub>6</sub> (12.0 vs. 6.5 ppt) and CH<sub>4</sub> (7.0 vs. 2.5 ppm) than those collected from single, fixed background samples collected upwind of the experimental site. Mobile background samplers with no dosed tracer source also will be useful when dosed samplers are not available. In grazing systems, the mobile background samplers also can serve as a source of assessment of background concentrations of external marker used for estimation of feed intake based on faecal output estimation.

### 11.3 Sample quality assessment at collection and further processing

Quality of breath and background samples should be assessed by measuring the residual vacuum at the end of the collection period, which is usually around 24 hours. This requires collection vessels to be at full vacuum at the start of the collection period, and this should be confirmed with a vacuum gauge. Many laboratories deem samples to be acceptable if residual vacuum is in a small range about 50 kPa. Residual vacuum higher than the target will indicate a blocked flow restrictor, whereas residual vacuum lower than the target may indicate leaks in the system and compromised collection. Samples not meeting the target residual criterion should be discarded from further sample processing, but most importantly, the sample collection gear and the sample collection device should be replaced by a new ones.

Gas samples should be analysed soon after collection, as it allows close monitoring of efficient and successful sample collection from individual animals. Sometimes, however, it is not possible to analyse samples immediately after collection – if, for example, the experimental site is some distance from the laboratory, or the number of samples exceeds the sample analysis rate. If this is the case, samples should be carefully sub-sampled under positive pressure into gas-tight vials (see Chapter 8). Alternatively, the collection canisters can be stored pending analysis, preferably following pressurisation with nitrogen to preclude inflow of surrounding gases. If pressurisation is not needed for analysis, it can be omitted, provided there is liberal airflow around the canisters to preclude cross-contamination of CH<sub>4</sub> and SF<sub>6</sub>.

### 11.4 Steps to detect anomalous concentrations of gases in the samples

Prevailing weather during sample collection from grazing animals can affect the concentrations of gases in samples. For example, samples collected under windy conditions will have a lower concentration of target gases (dilution effect) than those collected under 'normal' conditions. Therefore, checking for extreme gas concentrations should be done on a day-to-day basis, rather than across the whole collection period. Recording weather conditions should be standard practice during grazing experiments.

Criteria for assessing suspicious data belonging to a particular animal should be assessed across days of sample collection. High-frequency sheep breath sampling has shown that SF<sub>6</sub> is excreted with eructation gases (Lassey et al., 2011). However, there is a suspicion that SF<sub>6</sub> may be withheld in the rumen and/or animal systems, or bypass the rumen head gas space trapped in feed particles and subsequently voided in faeces, resulting in estimations of CH<sub>4</sub> emissions outside the expected range. In fact, Pinares-Patiño et al. (2011) reported that, when sheep deployed with SF<sub>6</sub> permeation tubes were housed in respiration chambers and chamber's out flowing stream were sampled and analysed for CH<sub>4</sub> and SF<sub>6</sub> concentrations, some chambers had SF<sub>6</sub> concentrations near to background, whereas their CH<sub>4</sub> concentrations were normal. Post-mortem recovery of tubes from these animals revealed no apparent indication of tube malfunctioning.

Estimating CH<sub>4</sub> emissions by the tracer technique uses the pre-calibrated permeation rate of SF<sub>6</sub> (mg/d), as well as net concentrations of SF<sub>6</sub> (ppt) and CH<sub>4</sub> (ppm) in the breath sample and the background. Gere et al. (2010) suggested a way to detect the efficiency of SF<sub>6</sub> collection based on the 'normalised concentrations of SF<sub>6</sub> in the breath'. Normalised SF<sub>6</sub> concentration is calculated by dividing the net (above the background) concentration of SF<sub>6</sub> (ppt) from each animal by the pre-calibrated permeation rate of the SF<sub>6</sub> (mg/d) from the particular tube inserted in the animal.

Thus, assuming that weather effects on dilution of eructed and exhaled gases are homogeneous on any given day across all the experimental animals, concentrations of SF<sub>6</sub> in samples should reflect the amounts released from the permeation source. The normalised concentration of SF<sub>6</sub> allows cases of unusual SF<sub>6</sub> content in breath to be identified, based on extremely low or high concentrations of SF<sub>6</sub> in the sample. Such unusual SF<sub>6</sub> may be due to malfunctioning of permeation tubes, SF<sub>6</sub> retention within the digestive tract or alternative exit routes of the SF<sub>6</sub>. Statistical tools (see next section) may help detect anomalous data regarding SF<sub>6</sub> concentrations in samples.

The next step is to look at the CH<sub>4</sub>/SF<sub>6</sub> ratio of concentrations (ppm/ppt). This ratio will depend upon the permeation rate of the SF<sub>6</sub> source, as well as the CH<sub>4</sub> emission from the animal, which in turn is strongly dependent on feed intake. The SF<sub>6</sub> and CH<sub>4</sub> gases have different molecular weights, and while gravitational effects are many orders of magnitude smaller than other gas transport mechanisms, mass-independent mechanisms such as dispersion, convection and advection may influence the efficiency of gas collection in the sample. Consequently, a lower efficiency of SF<sub>6</sub> collection in the sample – relative to CH<sub>4</sub> – will increase the CH<sub>4</sub>/SF<sub>6</sub> ratio, and the CH<sub>4</sub> emission will be overestimated. Again, outlier data can be detected using statistical tools.

Another way to detect anomalous data in gas concentrations is to examine the ratio of CH<sub>4</sub> to CO<sub>2</sub>. Feed fermentation in the rumen produces both CH<sub>4</sub> and CO<sub>2</sub>, but most of the CO<sub>2</sub> excreted by the animal originates in the animal's metabolism, which production has different dynamics than that found in fermentation CO<sub>2</sub>. Nevertheless, data from both penned and grazing animals (Figure 11.2) show that CH<sub>4</sub> and CO<sub>2</sub> concentrations in samples are highly related, and within a particular experimental treatment, with animals managed in a similar way, there is also a close relationship



between mean CH<sub>4</sub> and CO<sub>2</sub> emissions. As long as the SF<sub>6</sub> tracer technique's gas analysis system can be expanded to measure CO<sub>2</sub> concentrations in breath samples, analyses of CH<sub>4</sub>/CO<sub>2</sub> and CO<sub>2</sub>/SF<sub>6</sub> concentration ratios may also help detect anomalous data.

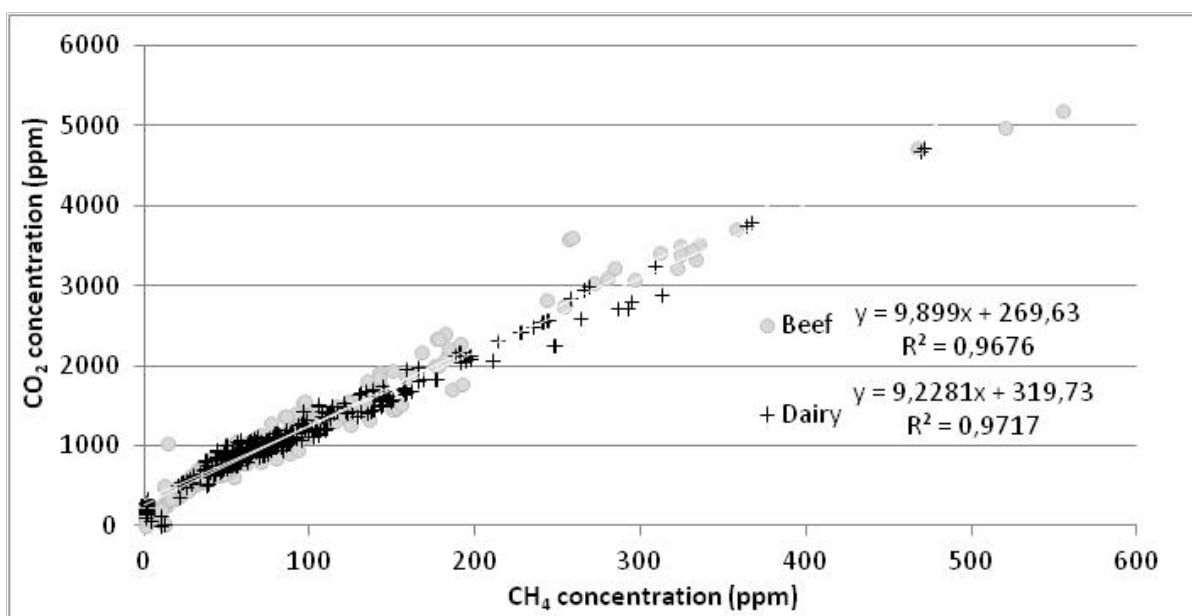

Figure 11.2: Net concentrations of CH<sub>4</sub> and CO<sub>2</sub> in gases collected using SF<sub>6</sub> sample collection apparatus over five consecutive days from beef and dairy cattle grazing tropical forages (Source: PECUS Project, EMBRAPA, Brazil).

### 11.5 Screening for outlier data

From a statistical point of view, an outlier is an observation numerically distant from the rest of the data; in other words, it deviates markedly from the rest. Outliers generally – but not always – coincide with maximum and/or minimum values. They increase variance, and by reducing the power of statistical tests, they may lead to deleterious and biased research conclusions if they do not represent actual extremes in the underlying population that are subject to inferences.

In CH<sub>4</sub> emission research, outlier data may arise from human data entry errors, mistakes in measurement protocols (SF<sub>6</sub> tracer technique and feed intake estimations) and extreme experimental animal conditions (sick animals, exceptional rumen conditions, extreme weather, etc.).

It is well known that the SF<sub>6</sub> technique can sometimes produce very high or very low CH<sub>4</sub> (g/d) data. When these data are converted to CH<sub>4</sub> yield (g CH<sub>4</sub>/kg DMI), values < 12 g CH<sub>4</sub>/kg DMI or > 30 g/kg DMI must be closely examined. This is because these values are considered biologically difficult to achieve under normal dietary conditions, and that values outside this range have not been reported in animals measured in



chambers, which is the most accurate method of measuring CH<sub>4</sub>. An exception to this, however, would be for experiments that included CH<sub>4</sub> inhibitors that could result in values < 12 g CH<sub>4</sub>/kg DMI.

It is common practice to remove outliers from data analysis. However, it is the researcher's responsibility to thoroughly examine suspicious data before removal. Removal of any data point can never be justified on statistical grounds alone: there must be biological or technical reasons that justify the exclusion of data values. For example, if there is a consistently low CH<sub>4</sub> yield from an animal, the researcher should first rule out possible causes for it: that the animal is eating normally, that it is a non rumen-fistulated animal, etc. The breath collection apparatus should also be checked for leaks or blocks in the tubes leading from nose harness to canister, or vacuum loss in the canister. If the permeation tube appears to be working normally, other methods of measuring CH<sub>4</sub> emission should be attempted. It may be that an exceptional animal has a low-emission rumen ecosystem. That animal could then be flagged as a highly important research tool.

There are various statistical tools to detect outlier data, which can be applied at various stages. For example, they can be applied to the 'Normalised PR', the 'CH<sub>4</sub>/SF<sub>6</sub> ratio', the 'CH<sub>4</sub> emission (g/d)' and the 'CH<sub>4</sub> yield (g/ kg DMI)'. The simplest methods for screening data for outliers are the 'Z-score' standardisation method (which requires data that are approximately normally distributed) and the 'modified (or robust) Z-score' (which copes with moderate non-normality in the data).

The 'Z-score' screens data on the basis of mean and standard deviation of the data set, whereas the 'modified Z-score' or 'robust Z-score' uses robust measures of centre and spread in its standardization – such as median and inter-quartile range – or the trimmed mean and standard deviation (Seo, 2006). An example can be found in the paper by Grainger et al. (2007). The 'modified Z-score' is preferred to the 'Z-score', because the sample mean and sample standard deviation can be affected by a few extreme values, or even by a single extreme value. Data associated with 'modified Z-scores' of >3.5 (absolute value) are labelled outliers. The Excel program can be used for this purpose.

Outliers beyond a biologically acceptable range can also be excluded or down-weighted in the analysis, but the researcher must, in any paper submitted for review by a journal, justify their reasons in the manuscript. We suggest a suitable range, that could be justified as biologically doubtful, of values < 12 g CH<sub>4</sub>/kg DMI or > 30 g/kg DMI.

Tables 11.1 and 11.2 summarise data (over a single day) for a grazing trial with cattle involving the SF<sub>6</sub> tracer technique for CH<sub>4</sub> emission estimation. The 'modified Z-score' detected that, on that particular day of sample collection, the animals with ID 111 and 113 were outliers for the 'Normalised PR of SF<sub>6</sub>' (see Table 11.1), whereas the subsequent step of data screening for 'CH<sub>4</sub>/SF<sub>6</sub> ratio' did not find outlier data (once outliers in the previous screening were removed). This process can be continued for CH<sub>4</sub> emission (g/d) and CH<sub>4</sub> yield (g/kg DMI).

**Table 11.1: Screening of 'Normalised PR of SF<sub>6</sub>' for outliers. Breath samples collected from 28 grazing cattle.***Data are for a single day. Data are presented as for an Excel format.*

	A	B	C	D	E	F	G	H
1	ID	PR SF <sub>6</sub> (mg/d)	Net SF <sub>6</sub> (ppt)	Net CH <sub>4</sub> (ppm)	Norm PR (ppt/mg/d)	Z <sub>i</sub>	Z <sub>i</sub> Label	
2	101	2.343	44.8	21.0	19.1	-0.92	NORMAL	<b>28.92</b>
3	102	5.487	169.6	38.3	30.9	0.19	NORMAL	<b>7.18</b>
4	103	4.469	84.6	23.6	18.9	-0.94	NORMAL	
5	104	6.585	207.4	36.6	31.5	0.24	NORMAL	
6	105	5.303	154.4	33.8	29.1	0.02	NORMAL	
7	106	4.960	104.9	24.8	21.1	-0.73	NORMAL	
8	107	3.190	137.3	48.1	43.0	1.33	NORMAL	
9	108	4.688	99.4	22.2	21.2	-0.73	NORMAL	
10	109	2.598	108.5	55.7	41.8	1.21	NORMAL	
11	110	5.253	154.1	38.5	29.3	0.04	NORMAL	
12	111	5.519	433.3	89.3	78.5	4.66	<b>OUTLIER</b>	
13	112	2.376	59.1	31.9	24.9	-0.38	NORMAL	
14	113	4.866	502.1	122.5	103.2	6.98	<b>OUTLIER</b>	
15	114	4.458	128.0	43.5	28.7	-0.02	NORMAL	
16	115	3.816	124.6	35.2	32.6	0.35	NORMAL	
17	116	5.448	101.3	18.3	18.6	-0.97	NORMAL	
18	117	5.062	77.6	16.4	15.3	-1.28	NORMAL	
19	118	5.920	132.1	30.5	22.3	-0.62	NORMAL	
20	119	6.252	177.9	34.8	28.5	-0.04	NORMAL	
21	120	2.397	85.0	44.4	35.5	0.61	NORMAL	
22	121	4.331	107.1	29.3	24.7	-0.39	NORMAL	
23	122	3.622	150.1	55.1	41.4	1.18	NORMAL	
24	123	4.437	104.9	32.8	23.6	-0.50	NORMAL	
25	124	2.978	168.1	77.2	56.5	2.59	NORMAL	
26	125	4.360	97.2	32.4	22.3	-0.62	NORMAL	
27	126	3.287	150.6	49.5	45.8	1.59	NORMAL	
28	127	3.972	132.5	38.0	33.4	0.42	NORMAL	
29	128	4.164	77.1	22.8	18.5	-0.98	NORMAL	

**Notes:** Concentrations of SF<sub>6</sub> and CH<sub>4</sub> are net (i.e., 17 ppm SF<sub>6</sub> and 5 ppm CH<sub>4</sub>, determined using mobile backgrounds, have been subtracted). The value 28.92 is the median for the 'Norm PR' data set, and the value 7.18 the corresponding MAD. In Excel, the value 7.18 is obtained by writing the formula: `=MEDIAN(ABS(MEDIAN(E2:E29)-E2:E29))` in the cell H3. Then, once the cursor is at the end of the formula and Ctrl+Shift+Enter hit, the correct formula should appear as: `{=MEDIAN(ABS(MEDIAN(E2:E29)-E2:E29))}`. The column F shows the 'modified Z-score' (i.e., z<sub>i</sub>) for each observation. This is calculated using the formula  $z_i = 0.6745 (x_i - x_m)/MAD$ , in which x<sub>i</sub> = observation value, z<sub>i</sub> = modified z-score of the observation, x<sub>m</sub> = median of the data set, and MAD = median { |x<sub>i</sub> - x<sub>m</sub>| }, as calculated in cell H3. The column G shows the z<sub>i</sub> labelling for each observation. The 'NORMAL' and 'OUTLIER' values are obtained by typing a formula: for example, for the cattle ID 101, the formula in cell G2 will be: `=IF(ABS((H$2-E2)*0.6745)>3.5*H$3), "OUTLIER", "NORMAL")`. The labels 'outlier' and 'normal' are automatically assigned when copied to the other cells in the column, depending on the absolute value (|...|) of the 'modified Z-score' of the particular observation. If z<sub>i</sub> > 3.5 it will be labelled as an outlier.

**Table 11.2: Screening of 'CH<sub>4</sub>/SF<sub>6</sub> ratio' for outliers. Breath samples collected from 28 grazing cattle.**

Animals with ID 111 and 113 were removed by the previous step, based on 'Normalised PR of SF<sub>6</sub>'

	A	B	C	D	E	F	G	H
	ID	PR SF <sub>6</sub> (mg/d)	Net SF <sub>6</sub> (ppt)	Net CH <sub>4</sub> (ppm)	CH <sub>4</sub> /SF <sub>6</sub> ratio	Zi	Zi label	
1								
2	101	2.3428	44.76	21.04	0.47	2.08	NORMAL	<b>0.285</b>
3	102	5.4868	169.61	38.31	0.23	-0.66	NORMAL	<b>0.060</b>
4	103	4.4694	84.59	23.56	0.28	-0.07	NORMAL	
5	104	6.5852	207.40	36.57	0.18	-1.21	NORMAL	
6	105	5.3026	154.45	33.81	0.22	-0.74	NORMAL	
7	106	4.9603	104.87	24.83	0.24	-0.54	NORMAL	
8	107	3.1899	137.27	48.06	0.35	0.73	NORMAL	
9	108	4.6876	99.40	22.18	0.22	-0.69	NORMAL	
10	109	2.5979	108.50	55.65	0.51	2.56	NORMAL	
11	110	5.2534	154.14	38.53	0.25	-0.39	NORMAL	
12	112	2.3762	59.13	31.93	0.54	2.86	NORMAL	
13	114	4.4582	128.04	43.54	0.34	0.62	NORMAL	
14	115	3.8164	124.60	35.19	0.28	-0.03	NORMAL	
15	116	5.4478	101.30	18.29	0.18	-1.17	NORMAL	
16	117	5.0619	77.61	16.37	0.21	-0.83	NORMAL	
17	118	5.9204	132.09	30.54	0.23	-0.60	NORMAL	
18	119	6.2519	177.94	34.82	0.20	-1.00	NORMAL	
19	120	2.3970	85.02	44.41	0.52	2.66	NORMAL	
20	121	4.3305	107.09	29.33	0.27	-0.12	NORMAL	
21	122	3.6222	150.07	55.13	0.37	0.93	NORMAL	
22	123	4.4365	104.91	32.83	0.31	0.32	NORMAL	
23	124	2.9780	168.15	77.16	0.46	1.95	NORMAL	
24	125	4.3599	97.17	32.41	0.33	0.55	NORMAL	
25	126	3.2873	150.64	49.53	0.33	0.49	NORMAL	
26	127	3.9725	132.54	38.03	0.29	0.03	NORMAL	
27	128	4.1636	77.09	22.77	0.30	0.12	NORMAL	

Notes: See Table 11.1 for calculation details. It is important that blank cells are deleted in order to allow correct calculation of MAD.

## 11.6 Conclusion

When estimating CH<sub>4</sub> emissions using the SF<sub>6</sub> tracer technique, quality assurance and quality control should be mandatory, to ensure data output validity and repeatability. Quality compliance implies actions at key stages of the process. It starts with ensuring that only permeation tubes with high linearity of mass loss rate are used, and that they are deployed into treatments in a balanced way. Then, the sample collection process

should ensure that correct residual vacuum is achieved at the end of the sample collection period, and representative background samples collected. Finally, outlier data are identified using statistical tools. The researcher should refrain from discarding data without thoroughly scrutinising it first.

## 11.7 References

Deighton, M.H, O'Loughlin, B.M, Williams, S.R.O, Moate, P.J, Kennedy, E, Boland, T.M & Eckard, R.J, 2013. Declining sulphur hexafluoride permeability of fluoropolymer membranes causes overestimation of calculated ruminant methane emissions using the tracer technique. *Anim. Feed Sci. Tech.* 183, 86-95.

Gere, J.I & Gratton, R, 2010. Simple, low-cost flow controllers for time averaged atmospheric sampling and other applications. *Lat. Am. Appl. Res.* 40, 377-381.

Gere, J.I, Williams, K.E, Gratton, R, Juliarena, M.P & Pinares-Patiño, C.S, 2010. The SF<sub>6</sub> tracer technique for methane emission estimation: the normalized mixing ratio of SF<sub>6</sub> across days of breath sampling. Page 90. E.J. Mc Geough and S.M. McGinn (EDs.). Proceedings of the 4th International Conference on Greenhouse Gases and Animal Agriculture, Banff, Canada, October 3-8, 2010.

Grainger C, Clarke T, McGinn S.M, Auld M.J, Beauchemin K.A, Hannah M, Waghorn G.C, Clark H & Eckard R.J, 2007. Methane emissions from dairy cows measured with the sulfur hexafluoride (SF<sub>6</sub>) tracer and chamber techniques. *J. Dairy Sci.* 90, 2755-2766.

Hall, B.D, Dutton G.S, Mondeel, D.J, Nance, J.D, Rigby, M, Butler, J.H, Moore, F.L, Hurst, D.F & Elkins, J.W, 2011. Improving measurements of SF<sub>6</sub> for the study of atmospheric transport and emissions. *Atmos. Meas. Tech.* 4, 2441-2451.

Hegarty, R.S, Goopy, J.P, Herd, R.M & McCorkell, B, 2007. Cattle selected for lower residual feed intake have reduced daily methane production. *J. Anim. Sci.* 85, 1479-1486.

Lassey, K.R. 2013. On the importance of background sampling in applications of the SF<sub>6</sub> tracer technique to determine ruminant methane emissions. *Anim. Feed Sci. Tech.* 180, 115- 120.

Lassey, K.R, Pinares-Patiño, C.S, Martin, R.J, Molano, G, & McMillan, A.M.S, 2011. Enteric methane emission rates determined by the SF<sub>6</sub> tracer technique: the influence of averaging time. *Anim. Feed Sci. Tech.* 166-167, 183-191.

Lassey, K.R, Walker, C.F, McMillan, A.M.S, & Ulyatt, M.J, 2001. On the performance of SF<sub>6</sub> permeation tubes used in determining methane emission from grazing livestock. *Chemosphere: Global Change Sci.* 3, 367-376.

Martin, C, Koolaard, J, Rochette, Y, Clark, H, Jouany, J.P and Pinares-Patiño, C.S, 2012. Effect of release rate of the SF<sub>6</sub> tracer on methane and carbon dioxide emission estimates based on ruminal and breath gas samples. *Animal* 6, 518-525.

Pinares-Patiño, C. S, 2000. Methane emission from forage-fed sheep, a study of variation between animals. Ph.D. Thesis, Massey University, Palmerston North, New Zealand. 226 pp.

Pinares-Patiño, C.S. & Clark, H, 2008. Reliability of the sulfur hexafluoride tracer technique for methane emission measurement from individual animals: an overview. *Aust. J. Exp. Agric.* 48, 223-229.

Pinares-Patiño, C.S, Lassey, K.R, Martin, R.J, Molano, G, Fernandez, M, MacLean, S, Sandoval, E, Luo, D & Clark, H, 2011. Assessment of the sulphur hexafluoride (SF<sub>6</sub>) tracer technique using respiration chambers for estimation of methane emissions from sheep. *Anim. Feed Sci. Tech.* 166-167, 201-209.

Rochette, Y, Eugène, M, Doreau, M, Morgavi, D.P & Martin, C, 2012. Determination of enteric methane emission by SF<sub>6</sub> tracer technique: permeation tubes must be calibrated after incubation in the rumen for an accurate quantification. International Symposium on Emissions of Gas and Dust from Livestock, 10 au 13 Juin 2012, Saint-Malo, France, 125-129.

Seo, S, 2006. A Review and Comparison of Methods for Detecting Outliers in Univariate Data Sets. Master Thesis University of Pittsburgh. <http://d-scholarship.pitt.edu/7948/1/Seo.pdf>

Swainson, N.M, 2011. Methane Emissions and Mitigation Technologies in Cattle, Sheep and Red Deer. PhD Thesis, Massey university, Palmerston North, New Zealand.

Williams, S.R.O, Moate, P.J, Hannah, M.C, Ribaux, B.E, Wales, W.J & Eckard, R.J, 2011. Background matters with the SF<sub>6</sub> tracer method for estimating enteric methane emissions from dairy cows: A critical evaluation of the SF<sub>6</sub> procedure. *Anim. Feed Sci. Tech.* 170, 265-276.

## 12 SF<sub>6</sub> REPORTING

S.R.O Williams<sup>a\*</sup>, M.H Deighton<sup>a</sup> & P.J Moate<sup>a</sup>

<sup>a</sup>Department of Environment and Primary Industries (DEPI), Ellinbank, Victoria, Australia

\*Corresponding Author: S.R.O. Williams; [richard.williams@depi.vic.gov.au](mailto:richard.williams@depi.vic.gov.au)

---

The methodology of an experiment needs to be presented in sufficient detail to allow others to repeat the work. Williams et al. (2011) reviewed published papers describing a sulphur hexafluoride (SF<sub>6</sub>) technique and highlighted some limitations in the detailing of the techniques used. The following sections outline the minimum information required to describe how a SF<sub>6</sub> technique was employed.

### 12.1 Permeation tubes

The characteristics of permeation tubes are related to their design, charge (the payload of SF<sub>6</sub>) and initial flow rate. The recommended minimum characteristics for reporting include:

- Tube design, which requires a detailed description, including internal volume, or cite a reference.
- Charge (SF<sub>6</sub>, g/tube) immediately prior to calibration, expressed as a mean ± standard deviation.
- Release rate of SF<sub>6</sub> (mg/day) at the time of insertion into the animals, expressed as a mean ± standard deviation.

A description of the process used, or a reference to a process to calibrate permeation tubes, is essential. If referencing a method, it is expected that the method used will be described exactly, and any variations must be detailed. When describing a SF<sub>6</sub> technique, the following information is regarded as the minimum recommended detail:

- How the loss of SF<sub>6</sub> was determined (usually by weighing).
- The duration of the calibration process.
- How frequently tubes were weighed.
- The calibration temperature (usually 39°C for cattle).

- How the temperature was achieved; e.g., water bath, incubator. If a water bath was used, were the tubes immersed, or kept dry in containers within the water bath?
- How the release rate was calculated; e.g., linear regression, quadratic (Lassey et al., 2001), or estimated using Michaelis-Menten kinetics (Moate et al., 2013)
- Whether the tubes were freshly charged with SF<sub>6</sub>, or used following storage at low temperature, including the duration and temperature of storage (Deighton et al., 2011).

Other permeation tube details that should be reported include the intervals between completion of calibration and insertion into the animal, and between insertion and the first measurement; the insertion method (per os or per fistula) and the number of permeation tubes per animal. If the tubes were inserted per fistula, were they placed in the rumen, or placed in the reticulum?

For example:

*Permeation tubes were filled in June 2011 by NIWA (National Institute of Water and Atmospheric Research), New Zealand, and were of the design described by Lassey et al (2001). Initial charge of SF<sub>6</sub> in the tubes was 2268 ± 92 mg (mean ± standard deviation). The SF<sub>6</sub> release rates were 4.7 ± 1.10 mg/day, and ranged from 2.8 to 6.10 mg/day.*

*Tubes were calibrated by weighing (Sartorius CP224S, Sartorius AG, Goettingen, Germany) every Tuesday and Friday for 49 days. A dry incubator (Contherm Digital Series 5 Incubator, Contherm Scientific, Lower Hutt, New Zealand) was set at 39°C, and validated using a thermometer (Surgipack mercurial thermometer, Model: 6338, Tyco Healthcare, Lane Cove, New South Wales, Australia).*

*Release rate was calculated by linear regression of the permeation tube weights obtained during the calibration period. On completion of calibration, tubes were inserted into the cows per os seven days before the first methane measurement.*

## 12.2 Animal accommodation

Where and how the animals are accommodated will affect the number of background samples required, and – if animals spend a part of their time indoors and part outdoors – the calculation method. A photograph or schematic plan of the enclosure might convey more than a complex description.

For example:

*Animals were housed in a single row of stalls along the open, north side of a naturally ventilated animal house 22 m wide by 61 m long, with internal*



*volume of ~7500 m<sup>3</sup>. An open ridge vent runs the length of the roof, and no other animals shared the building during the experiment.*

### 12.3 Breath samples

The manner of sampling eructated gases may appear simple, but there are several variations reported in the literature. Were evacuated canisters used, or an active pumping system? What was the canister design, material and internal volume? Did each canister collect gas over 24 hours, multiple days or only part of a day? How was the rate of sampling achieved? What held the sampling gear in position on the animal or fence?

For example:

*Details describing the sampling equipment, analytical equipment and protocols for using the tracer technique have been described previously (Grainger et al. 2007). In this experiment, we employed 800 ml stainless-steel gas-collection canisters, which had been flushed before use. The flushing process involved four cycles of filling with air, then evacuating to 95 kPa, followed by a filling with ultra high purity N<sub>2</sub> gas (999.99 g kg N<sub>2</sub>) and then evacuated to at least 97 kPa vacuum. Initial sampling rate was ~0.20 ml/min. Flow restriction was achieved by means of a stainless-steel capillary tube (56712-U; Supelco, Bellefonte, PA, USA) cut to 30 mm length, then crimped using vice-grips until the desired flow was achieved.*

### 12.4 Background samplers

Local, ambient concentrations of both SF<sub>6</sub> and CH<sub>4</sub> can vary from day to day and from place to place, especially indoors, or outdoors if wind speed and direction are variable. To account for this, it is necessary to sample a sufficient number of locations to representatively sample the local background concentrations of gases experienced by each animal. Outdoors, this may simply involve one sampling point at each compass point of the animal paddock or yard. Indoors, a two- or three-dimensional grid may be necessary. Wherever sampling points are located, it is important to describe their location relative to the animals and their height(s) above the ground. See Chapter 7 for more information.

For example:

*Background concentrations of SF<sub>6</sub> and CH<sub>4</sub>, both inside the animal house and outside at the loafing pad, were sampled using canisters of the same design as those used on the cows. Indoors, canisters were fitted to the stall fencing at eight locations, evenly distributed along the stalls (see Fig. 1) and about 1.1 m above the floor and mid-way between adjacent cows (i.e., approximately 0.75 m from each cow). These sampling canisters were only*

*active during the seven hours the cows were indoors, and used an initial flow rate of ~0.8 ml/min, so that sufficient sample was collected (about 50 kPa vacuum remaining). Outdoors, canisters were positioned one on each of the north, east, south and west fences at the midpoint of the top wire. These canisters were only active when the cows were loafing, and used an initial flow rate of ~0.6 ml/min, so that sufficient sample was collected. Both the indoor and outdoor canisters were changed for fresh canisters using the same sequence as for those on the cows.*

*The background concentrations of SF<sub>6</sub> and CH<sub>4</sub> indoors for each day were modelled (using Microsoft Excel 2003) by quadratic equations to enable the estimation of a local indoor background concentration for each individual cow. Outdoor concentrations were averaged to give a single estimate for all cows. For each cow, an overall background concentration was calculated based on an average of indoor and outdoor concentrations weighted according to the time the cows were in each location.*

## 12.5 Sample preparation

Depending on site-specific arrangements, collected samples may undergo some preparation before analysis, due to a need to store samples for later analysis, or to enable the sample to be more easily transferred to the gas chromatograph.

For example:

*The vacuum of evacuated canisters was measured using a digital gauge (XP2i-DP, Crystal Engineering, San Luis Obispo, CA, USA) and recorded. When the canisters had been used to collect breath samples, the vacuum ( $\tau_s$ ) of individual canisters was again measured using the same gauge and recorded. Ultra-high-purity N (999.99 g/kg N<sub>2</sub>) was then added to each canister to achieve a vacuum of ~10 kPa with the actual vacuum achieved ( $\tau_f$ ) being measured using the same gauge and recorded.*

## 12.6 Sample analysis

The most common method of analysing collected gas samples is by gas chromatography. There are many aspects, options and adjustments available in this process, so it is essential to accurately describe them all.

For example:

*Gas samples were analysed using a gas chromatograph (Varian CP-3800, Varian Analytical Instruments, Walnut Creek, CA, USA) fitted with a Nafion dryer (MD-110-24F-2, Perma Pure, Toms River, NJ, USA) to dry the samples. Ultra-high-purity nitrogen (99.999% N<sub>2</sub>) was used as the carrier gas through two parallel columns operating at 80°C. Separation of CH<sub>4</sub> was achieved*

using an Alltech Porapak-Q 80-100 mesh column (3.6 m x 3 mm stainless steel, Grace Davison Discovery Sciences, Deerfield, IL, USA) operated at a pressure of 310 kPa. Detection was by a flame ionisation detector operating at 250°C. Separation of SF<sub>6</sub> was achieved using an Alltech Molecular Sieve 5A 80-100 mesh column (1.8 m x 3 mm stainless steel, Grace Davison Discovery Sciences, Deerfield, IL, USA) using a flow rate of 30 ml/min. Detection was by an electron capture detector operated at 300°C.

The gas chromatograph was baked out overnight by slowly raising the oven temperature to 250°C, while bypassing the electron capture detector. The oven temperature was held for 10 hours, then slowly reduced to 80°C. Samples were drawn from the canisters to the GC using a positive displacement, diaphragm pump (Thomas, 7006VD/2,3/E/AC, Gardner Denver Thomas Australia, Wetherill Park, NSW, Australia) fitted to the exhaust of the GCs 7 ml sampling loop.

## 12.7 Methane calculation

Converting the measured gas concentration into methane (CH<sub>4</sub>) emissions is a critical step. The equations used to calculate CH<sub>4</sub> emissions must be accurately reported or cited, including processes such as accounting for dilution of gases resulting from the addition of nitrogen to collected samples.

For example:

*Methane emissions were calculated in a two-part process. The first step was to mathematically account for the physical dilution of the samples with N gas prior to analysis (Eqn 12.1):*

$$[G_s] = \frac{101 - t_f}{t_e - t_s} \cdot [G_A] \quad \text{Eqn 12.1}$$

*Where [GS] (same units as [GA]) is the calculated concentration of the gas as sampled, 101 is the average atmospheric pressure (kPa),  $t_f$  (kPa) is the final vacuum in the canister after the addition of nitrogen,  $t_s$  (kPa) is the vacuum in the canister after the sample is collected,  $t_e$  (kPa) is the vacuum in the evacuated canister before use, and [GA] (ppm for CH<sub>4</sub>, ppt for SF<sub>6</sub>) is the gas concentration in the sample presented to the GC.*

*The second step was to use the calculated gas concentrations to calculate the CH<sub>4</sub> emissions, as described by Williams et al. (2011).*

## 12.8 Data analysis

Analysis of data is often the final step of an experiment. This may include the identification of invalid data, outlying data and statistical analysis. Each of these processes must be adequately described. If data are excluded, was this due to equipment failures, animal health issues or some other reason? Was a process used to identify outlying data? If so, what was it? If outlying data were identified, were they excluded, and why? How were the data statistically analysed?

For example:

*Data from two cows (one treatment and one control) were excluded due to severe mastitis infections and subsequent treatment with antibiotics. A modified Z-score was used to identify outlying data. While some outliers were identified, all values were retained for statistical analysis, as no experimental anomalies could be identified to justify their exclusion.*

*All data were analysed by ANOVA or, where corresponding covariate data were available, by ANCOVA, using GenStat 14 software. The statistical model was specified as follows:*

$$y_{ij} = \mu + \tau_j + \beta x_{ij} + \epsilon_{ij}$$

*Where  $y_{ij}$  is the response for animal  $i$  on treatment  $j$ ,  $\mu$  is a constant,  $\tau_j$  is an effect of treatment  $j$ ,  $\beta x_{ij}$  is a linear adjustment for covariate  $x_{ij}$  (if available), and  $\epsilon_{ij}$  is an independent random error. Contrasts (t-tests) were used to test differences between treatment means and differences between treatment and control diets. Distributional assumptions of normality and constant variance were checked visually, using graphs of residuals against fitted values, and histograms and normal quantile plots of residuals. ANOVA F-statistic P-values were derived by Monte Carlo permutation.*

## 12.9 References

Deighton, M.H, O'Loughlin, B.M, Buckley, F & Boland, T.M, 2011. A simple method for pre-calibration storage of sulfur hexafluoride permeation tubes. *Anim. Feed Sci. Tech.* 166–167, 198-200.

Grainger, C, Clarke, T, McGinn, S.M, Auld, M.J, Beauchemin, K.A, Hannah, M.C, Waghorn, G.C, Clark, H & Eckard, R.J, 2007. Methane emissions from dairy cows measured using the sulfur hexafluoride (SF<sub>6</sub>) tracer and chamber techniques. *J. Dairy Sci.* 90, 2755-2766.

Lassey, K.R, Walker, C.F, McMillan, A.M.S & Ulyatt, M.J, 2001. On the performance of SF<sub>6</sub> permeation tubes used in determining methane emissions from grazing livestock. *Chemosphere* 3, 367-376.

Moate, P.J, Williams, S.R.O, Deighton, M.H, Lassey, K.R, Ribaux, B.E & Hannah, M.C, 2013. Rate of release of SF<sub>6</sub> from permeation tubes is described by Michaelis-Menten kinetics. Greenhouse Gases in Animal Agriculture conference, Dublin 2013.

Williams, S.R.O, Moate, P.J, Hannah, M.C, Ribaux, B.E & Eckard, R.J, 2011. Background matters with the SF<sub>6</sub> tracer method for measuring enteric methane emissions from dairy cows. *In preparation.*

## 13 BIBLIOGRAPHY

This bibliography contains a list of peer-reviewed papers applying to SF<sub>6</sub> tracer techniques. It does not contain reviews or papers that merely mention the fact that a SF<sub>6</sub> technique can be used to measure enteric methane emissions. This list was compiled by Peter J. Moate, S. Richard O. Williams, Matthew H. Deighton, Brigid E. Ribaux, Cécile Martin, and Keith R. Lassey.

---

Allard, V, Soussana, J.F, Falcimagne, R, Berbigier, P, Bonnefond, J.M, Ceschia, E, D'hour, P, Hénault, C, Laville, P, Martin, C & Pinarès-Patino, C, 2007. The role of grazing management for the net biome productivity and greenhouse gas budget (CO<sub>2</sub>, N<sub>2</sub>O and CH<sub>4</sub>) of semi-natural grassland. *Agric. Ecosyst. Environ.* 121, 47-58.

Bárbaro, N, Gere, J, Gratton, R, Rubio, R & Williams, K, 2008. First measurements of methane emitted by grazing cattle of the Argentinean beef system. *NZ J. Agric. Res.* 51, 209-219.

Beauchemin, K.A, Coates, T, Farr, B & McGinn, S.M, 2012. Can the Sulfur hexafluoride tracer gas technique be used to accurately measure enteric methane production from ruminally cannulated cattle? *J. Anim. Sci.* 90, 2727-2732.

Behlke, E.J, Sanderson, T, Klopfenstein, T.J & Miner, J.L, 2007. Replacement of forage with dried distillers grains reduces ruminal methane production. Nebraska beef cattle reports, University of Nebraska-Lincoln, <http://digitalcommons.unl.edu/Animalscibcr/62>.

Bhatta, R, Tajima, K, Takusari, N, Higuchi, K, Enishi, O & Kurihara, M, 2006. Comparison of sulfur hexafluoride tracer technique, rumen simulation technique and in vitro gas production techniques for methane production from ruminant feeds. *International Congress Series* 1293, 58-61.

Boadi, D.A & Wittenberg, K.M, 2002. Methane production from dairy and beef heifers fed forages differing in nutrient density using the sulphur hexafluoride (SF<sub>6</sub>) tracer gas technique. *Can. J. Anim. Sci.* 82, 201–206.

Boadi, D.A, Wittenberg, K.M & Kennedy, A.D, 2002. Validation of the sulphur hexafluoride (SF<sub>6</sub>) tracer gas technique for measurement of methane and carbon dioxide production by cattle. *Can. J. Anim. Sci.* 82, 125–131.

Boadi, D.A, Wittenberg, K.M & McCaughey, W.P, 2002. Effects of grain supplementation on methane production of grazing steers using the sulphur (SF<sub>6</sub>) tracer gas technique. *Can. J. Anim. Sci.* 82, 151–157.

Boadi, D.A, Wittenberg, K.M, Scott, S.L, Burton, D, Buckley, K, Small, J.A & Ominski, K.H, 2004. Effect of low and high forage diet on enteric and manure pack greenhouse gas emissions from a feedlot. *Can. J. Anim. Sci.* 84, 444–453.

Boland, T.M, 2011. A simple method for pre-calibration storage of sulphur hexafluoride permeation tubes. *Anim. Feed Sci. Tech.* 166-167, 198-200.

Cavanagh, A, McNaughton, L, Clark, H, Greaves, C, Gowan, J.M, Pinares–Patino, C.S, Dalley, D.E, Vlaming, B & Molano, G, 2008. Methane emissions from grazing Jersey × Friesian dairy cows in mid lactation. *Aust. J. Exp. Agric.* 48, 230–233.

Chaves, A.V, Thompson, L.C, Iwaasa, A.D, Scott, S.L, Olson, M.E, Benchaar, C, Veira, D.M & McAllister, T.A, 2006. Effect of pasture type (alfalfa vs. grass) on methane and carbon dioxide production by yearling beef heifers. *Can. J. Anim. Sci.* 86, 409–418.

Chilliard, Y, Martin, C, Rouel, J & Doreau M, 2009. Milk fatty acids in dairy cows fed linseed, extruded linseed, or linseed oil, and their relationship with methane output. *J. Dairy Sci.* 92, 5199–5211.

Chung, Y-H, He, M.L, McGinn, S.M, McAllister, T.A & Beauchemin, K.A, 2011. Linseed suppresses enteric methane emissions from cattle fed barley silage, but not from those fed grass hay. *Anim. Feed Sci. Tech.* 166-167, 321-329.

Chung, Y-H, Walker, N.D, McGinn, S.M & Beauchemin, K.A, 2011. Differing effects of 2 active dried yeast (*Saccharomyces cerevisiae*) strains on ruminal acidosis and methane production in nonlactating dairy cows. *J. Dairy Sci.* 94, 2431-2439.

Chung, Y-H, Zhou, M, Holtshausen, L, Alexander, T.W, McAllister, T.A, Guan, L.L, Oba, M & Beauchemin, K.A, 2012. A fibrolytic enzyme additive for lactating Holstein cows diets: Ruminal fermentation, rumen microbial populations, and enteric methane emissions, 2012. *J. Dairy Sci.* 95, 1419-1427.

Cosgrove, G.P, Waghorn, G.C, Anderson, C.B, Peters, J.S, Smith, A, Molano, G, Deighton & M, 2008. The effect of oils fed to sheep on methane production and digestion of ryegrass pasture. *Aust. J. Exp. Agric.* 48, 189–192.

Deighton, M.H, O'Loughlin, B.M, Boland, T.M & Buckley, F, 2011. Gas sampling error in the ERUCT technique: effect of sample cross-contamination, Proc. Agricultural Research Forum, Tullamore, Co. Offaly, Ireland, 14-15 March, pp62.

Deighton, M.H, O'Loughlin, B.M, Buckley, F, Deighton, M.H, O'Loughlin, B.M, Boland, T.M & Buckley, F, 2011. Gas sampling error in the ERUCT technique: effect of sample cross-contamination, Proc. Agricultural Research Forum, Tullamore, Co. Offaly, Ireland, 14-15 March, pp62.

Deighton, M.H, O'Loughlin B.M, Williams S.R.O, Moate P.J, Kennedy E, Boland T.M & Eckard R.J, 2013. Declining sulphur hexafluoride permeability of fluoropolymer



membranes causes overestimation of calculated ruminant methane emissions using the tracer technique. *Anim. Feed Sci. Tech.* 183: 86-95.

Deighton, M.H, Williams, S.R.O, Eckard, R.J, Ribaux, B & Moate, P.J, 2012. A High concordance is possible between methane emissions from individual dairy cows measured by the SF<sub>6</sub> tracer and respiration chamber techniques. Proc. of the 5th Australasian Dairy Science Symposium 2012, 448-449.

Deighton, M.H, Wims, C.M, O'Loughlin, B.M, Lewis, E & O'Donovan, M, 2010. Effect of sward maturity on the dry matter intake, enteric methane emission and milk solids production of pasture grazed dairy cows. *Advances in Anim. Biosciences* 1, 262-262.

De Oliveira, S.G, Berchielli, T.T, Pedreira, M, Primavesi, O, Frighetto, R & Lima, M.A, 2007. Effect of tannin levels in sorghum silage and concentrate supplementation on apparent digestibility and methane emission in beef cattle. *Anim. Feed Sci. Tech*, 135, 236-248.

DeRamus, H.A, Clement, T.C, Giampola, D.D & Dickison, P.C, 2003. Methane emissions of beef cattle on forages: efficiency of grazing management systems. *J. Environ. Qual.* 32, 269–277.

Doreau, M, Van der Werf, H.M.G, Micol D, Dubroeuq, H, Agabriel, J, Rochette, Y & Martin, C, 2011. Enteric methane production and greenhouse gases balance of diets differing in concentrate in the fattening phase of a beef production system. *J. Anim. Sci*, 89, 2518-2528.

Eugène M, Martin, C, Mialon, M.M, Krauss, D, Renand, G & Doreau, M, 2011. Dietary linseed and starch supplementation decreases methane production of fattening bulls. *Anim. Feed Sci. Technol*, 166-167, 330-337.

Foley, P.A, Kenny, D.A, Callan, J.J, Boland, T.M & O'Mara, F.P, 2009. Effect of DL-malic acid supplementation on feed intake, methane emission, and rumen fermentation in beef cattle. *J. Anim. Sci.* 87, 1048–1057.

Foley, P.A, Kenny, D.A, Lovett, D.K, Callan, J.J, Boland, T.M & O'Mara, F.P, 2009. Effect of DL-malic acid supplementation on feed intake, methane emissions, and performance of lactating dairy cows at pasture. *J. Dairy Sci.* 92, 3258–3264.

Gere, J.I & Gratton, R, 2010. Simple, low-cost controllers for time averaged atmospheric sampling and other applications. *Latin Amer. Appl. Res.* 40, 377–381.

Gill, F.L, Dewhurst, R.J, Evershed, R.P, McGeough, E, O'Kiely, P, Pancost, R.D & Bull, I.D, 2011. Analysis of archaeal ether lipids in bovine faeces. *Anim. Feed Sci. Technol*, 166-167, 87-92.

Gill, F.L, Pancost, R.D, Bull, I.D, McGeough, E, O'Kiely, P & Dewhurst, R.J, 2010. Investigation of faecal archaeol as a biomarker for rumen methanogens. *Advances in Anim. Biosciences*, 1, 48-48.

Goopy, J.P & Hegarty, R.S, 2004. Repeatability of methane production in cattle fed concentrate and forage diets. *J. Anim. Feed Sci.* 13, 75–78.

Grainger, C, Auldist, M.J, Clarke, T, Beauchemin, K.A, McGinn, S.M, Hannah, M.C, Eckard, R.J & Lowe, L.B, 2008. Use of monensin controlled-release capsules to reduce methane emissions and improve milk production of dairy cows offered pasture supplemented with grain. *J. Dairy Sci.* 91, 1159–1165.

Grainger, C & Beauchemin, K.A, 2011. Can enteric methane emissions from ruminants be lowered without lowering their production? *Anim. Feed Sci. Technol.* 166-167, 308-320.

Grainger, C, Clarke, T, Auldist, M.J, Beauchemin, K.A, McGinn, S.M, Waghorn, G.C & Eckard, R.J, 2009. Potential use of *Acacia mearnsii* condensed tannins to reduce methane emissions and nitrogen excretion from grazing dairy cows. *Can. J. Anim. Sci.* 89, 241-251.

Grainger, C, Clarke, T, Beauchemin, K.A, McGinn, S.M & Eckard, R.J, 2008. Supplementation with whole cottonseed reduces methane emissions and can profitably increase milk production of dairy cows offered a forage and cereal grain diet. *Aust. J. Exp. Agric.* 48, 73–76.

Grainger, C, Clarke, T, McGinn, S.M, Auldist, M.J, Beauchemin, K.A, Hannah, M.C, Waghorn, G.C, Clark, H & Eckard, R.J, 2007. Methane emissions from dairy cows measured using the Sulfur Hexafluoride (SF<sub>6</sub>) tracer and chamber techniques. *J. Dairy Sci.* 90, 2755-2766.

Grainger, C, Williams, R, Clarke, T, Wright, A.D.G & Eckard, R.J, 2010. Supplementation with whole cottonseed causes long-term reduction of methane emissions from lactating dairy cows offered a forage and cereal grain diet. *J. Dairy Sci.* 93, 2612–2619.

Guan, H, Wittenberg, K.M, Ominski, K.H & Krause, D.O, 2006. Efficacy of ionophores in cattle diets for mitigation of enteric methane. *J. Anim. Sci.* 84, 1896–1906.

Hammond, K.J, Muetzel, S, Waghorn, G.G, Pinares-Patino, C.S, Burke, J.L & Hoskin, S.O, 2009. The variation in methane emissions from sheep and cattle is not explained by the chemical composition of ryegrass. *Proc. NZ. Soc. Anim. Prod.* 69, 174–178.

Hart, K.J, Martin, P.G, Foley, P.A, Kenny, D.A & Boland, T.M, 2009. Effect of sward dry matter digestibility on methane production, ruminal fermentation, and microbial populations of zero-grazed beef cattle *J. Anim. Sci.* 87, 3342–3350.

Hegarty, R.S, Woodgate, R.T & Clark, D.A, 2003. Performance of high-flow permeation tubes releasing SF<sub>6</sub>. *Recent Adv. Anim. Nutr. Aust.* 14, 19A.

Hegarty, R.S, Goopy, J.P, Herd & R.M, McCorkell, B, 2007. Cattle selected for lower residual feed intake have reduced daily methane production. *J. Anim. Sci.* 85, 1479–1486.

Holtshausen, L, Chaves, A.V, Beauchemin, K.A, McGinn, S.M, McAllister & T, Odongo, N, 2009. Feeding saponin-containing *Yucca schidigera* and *Quillaja saponaria* to decrease enteric methane production in dairy cows. *J. Dairy Sci.* 92, 2809–2821.

Hristov, A.N, Van der Pol, M, Agle, M, Zaman, S, Schneider, P, Ndegwa, P, Vaddella, V.K, Johnson, K, Shingfield, K.J & Karnati, S.K.R, 2009. Effect of lauric acid and coconut oil on ruminal fermentation, digestion, ammonia losses from manure, and milk fatty acid composition in lactating cows. *J. Dairy Sci.* 92, 5561-5582.

Hulshof, R.B.A, Berndt, A, Gerrits, W.J.J, Dijkstra, J, van Zijderveld, S.M, Newbold, J.R & Perdok, H.B, 2012. Dietary nitrate supplementation reduces methane emission in beef cattle fed sugarcane-based diets. *J. Anim. Sci.* 90, 2317-2323.

Johnson, D.E, Johnson, K.A, Ward, G.M & Branine, M.E, 2000. Ruminants and other Animals, In: Khalil, M.A.K. (Ed.), Atmospheric Methane: Its Role in the Global Environment, Springer-Verlag, Berlin, pp. 112–133.

Johnson, K, Huyler, M, Westberg, H, Lamb, B & Zimmerman, P, 1994. Measurement of methane emissions from ruminant livestock using a SF<sub>6</sub> tracer technique. *Environ. Sci. Technol.* 28, 359–362.

Johnson, K.A & Johnson, D.E, 1995. Methane emissions from cattle. *J. Anim. Sci.* 73, 2483-2492.

Johnson, K.A, Kincaid, R.L, Westberg, H.H, Gaskins, C.T, Lamb & B.K, Cronrath, J.D, 2002. The effect of oilseeds in diets of lactating cows on milk production and methane emissions. *J. Dairy Sci.* 85, 1509–1515.

Johnson, K.A, Westberg, H.H, Lamb, B.K & Kincaid, R.L, 1998. The use of sulphur hexafluoride for measuring methane production by cattle, in: McCracken, K.J, Unsworth, E.F, Wylie, A.R.G. (Eds.), Energy Metabolism of Farm Animals, CAB International, Wallingford, U.K, pp. 189–192.

Johnson, K.A, Westberg, H.H, Lamb, B.K & Kincaid, R.L, 2000. An overview of the SF<sub>6</sub> technique for measuring methane emissions from cattle, Second International Conference on Methane Mitigation, Novosibirsk, Russia, pp. 103–108.

Johnson, K.A, Westberg, H.H, Michal, J.J & Cossalman, M.W, 2007. The SF<sub>6</sub> technique: methane measurement from ruminants, In: Makkar, H.P.S, Vercoe, P.E. (Eds.), Measuring methane production from ruminants, Springer, Dordrech, Netherlands, pp. 33–67.

Jordan, E, Kenny, D, Hawkins, M, Malone, R, Lovett, D.K & O'Mara, F.P, 2006. Effect of refined soy oil or whole soybeans on intake, methane output, and performance of young bulls. *J. Anim. Sci.* 84, 2418–2425.

Jordan, E, Lovett, D.K, Hawkins, M, Callan, J.J & O'Mara, F.P, 2006. The effect of varying levels of coconut oil on intake, digestibility and methane output from continental cross beef heifers. *J. Anim. Sci.* 82, 859–865.

Jordan, E, Lovett, D.K, Monahan, F.J, Callan, J, Flynn, B & O'Mara, F.P, 2006. Effect of refined coconut oil or copra meal on methane output and on intake and performance of beef heifers. *J. Anim. Sci.* 84, 162–170.

Judd, M.J, Kelliher, F.M, Ulyatt, M.J, Lassey, K.R, Tate, K.R, Shelton, I.D, Harvey, M.J & Walker, C.F, 1999. Net methane emissions from grazing sheep. *Glob. Change Biol.* 5, 647–657.

Kebreab, E, Clark, K, Wagner-Riddle, C & France, J, 2006. Methane and nitrous oxide emissions from Canadian *Animal* agriculture: A review. *Can. J. Anim. Sci.* 86(2), 135-157.

Knight, T, Rominus, R.S, Dey, D, Tootill, C, Naylor, G, Evans, P, Molano, G, Smith, A, Tavendale, M, Pinares-Patiño, C.S & Clark, H, 2011. Chloroform decreases rumen methanogenesis and methanogen populations without altering rumen function in cattle. *Anim. Feed Sci. Technol.* 166–167, 101-112.

Knight, T.W, Molano, G, Clark, H & Cavanagh, A, 2008. Methane emissions from weaned lambs measured at 13, 17, 25 and 35 weeks of age compared with mature ewes consuming a fresh forage diet. *Aust. J. Exp. Agric.* 48, 240–243.

Lassey, K.R, 2007. Livestock methane emission: from the individual grazing animal through national inventories to the global methane cycle. *Agric. For. Meteorol.* 142, 120–132, doi:10.1016/j.agrformet.2006.03.028.

Lassey, K.R, 2008. Livestock methane emission and its perspective in the global methane cycle. *Aust. J. Exp. Agric.* 48, 114-118, doi:10.1071/EA07220.

Lassey, K.R, 2013. On the importance of background sampling in applications of the SF<sub>6</sub> tracer technique to determine ruminant methane emissions. *Anim. Feed Sci. Technol.* 180, 115-120, doi:10.1016/j.anifeedsci.2012.11.012.

Lassey, K.R, Pinares-Patiño, C.S, Martin, R.J, Molano, G & McMillan, A.M.S, 2011. Enteric methane emission rates determined by the SF<sub>6</sub> tracer technique: Temporal patterns and averaging periods. *Anim. Feed Sci. Technol.* 166–167, 183–191, doi:10.1016/j.anifeedsci.2011.04.066.

Lassey, K.R, Pinares-Patiño, C.S & Ulyatt, M.J, 2002. Methane emission by grazing livestock: Some findings on emission determinants, In: van Ham, J, Baede, A.P.M, Guicherit, R, Williams-Jacobse, J.G.F.M. (Eds.), *Non-CO<sub>2</sub> Greenhouse Gases: Scientific Understanding, Control Options and Policy Aspects*, Millpress, Rotterdam, The Netherlands, pp. 95–100.

Lassey, K.R & Ulyatt, M.J, 2000. Methane emission by grazing livestock: A synopsis of 1000 direct measurements, In: van Ham, J, Baede, A.P.M, Meyer, L.A, Ybema, R. (Eds.), Non-CO<sub>2</sub> Greenhouse Gases: Scientific Understanding, Control and Implementation, Kluwer, Dordrecht, The Netherlands, pp. 101–106.

Lassey, K.R, Ulyatt, M.J, Martin, R.J, Walker, C.F & Shelton, I.D, 1997. Methane emissions measured directly from grazing livestock in New Zealand. *Atmos. Environ.* 31, 2905–2914.

Lassey, K.R, Walker, C.F, McMillan, A.M.S & Ulyatt, M.J, 2001. On the performance of SF<sub>6</sub> permeation tubes used in determining methane emission rates from grazing livestock. *Chemosphere – Global Change Sci.* 3, 367–376.

Laubach, J, Kelliher, F.M, Knight, T.W, Clark, H, Molane, G & Cavanagh, A, 2008. Methane emissions from beef cattle - a comparison of paddock- and animal-scale measurements. *Aust. J. Exp. Agric.* 48, 132–137.

Lee, J.M, Woodward, S.L, Waghorn, G.C & Clark, D.A, 2004. Methane emissions by dairy cows fed increasing proportions of white clover (*Trifolium repens*) in pasture. *Proc. of the New Zealand Grassland Association* 66, 151-155.

Leuning, R, Baker, S.K, Jamie, I.M, Hsu, C.H, Klein, L, Denmead, O.T & Griffith, D.W.T, 1999. Methane emission from free-ranging sheep: a comparison of two measurement methods. *Atmos. Environ.* 33, 1357–1365.

Lovett, D, Lovell, S, Stack, L, Callan, J, Finlay, M, Conolly, J & O'Mara, F.P, 2003. Effect of forage/concentrate ratio and dietary coconut oil level on methane output and performance of finishing beef heifers. *Livest. Prod. Sci.* 84, 135–146.

Lovett, D, Stack, L.J, Lovell, S, Callan, J, Flynn, B, Hawkins, M & O'Mara, F.P, 2005. Manipulating enteric methane emissions and animal performance of late-lactation dairy cows through concentrate supplementation at pasture. *J. Dairy Sci.* 88, 2836-2842.

Lynch, M.B, Kenny & D.A, Boland, T.M, 2010. An examination of the performance, nutrient digestibility, enteric methane emissions and rumen fermentation characteristics of beef cattle fed either barley or ground ear maize based diets. *Advances in Animal Biosciences*, 1, 43-43.

Machmüller, A, & Hegarty, R.S, 2006. Alternative tracer gases for the ERUCT technique to estimate methane emission from grazing animals. Int'l. Congress Series. 1293, 50-53.

Martin, C, Koolaard, J, Rochette, Y, Clark, H, Jouany, J.P & Pinares-Patiño, C, 2012. Effect of release rate of the SF<sub>6</sub> tracer on methane and carbon dioxide emission estimates based on ruminal and breath gas samples. *Animal*, 6(3), 518-525.

Martin, C, Morgavi, D.P & Doreau, M, 2009. Methane mitigation in ruminants: from microbe to the farm scale. *Animal*, 4(3), 351-365.

Martin, C, Rouel, J, Jouany, J.P, Doreau M & Chilliard, Y, 2008. Methane output and diet digestibility in response to feeding dairy cows crude linseed, extruded linseed, or linseed oil. *J. Anim. Sci.* 86, 2642–2650.

McCaughey, W.P, Wittenberg K & Corrigan, D, 1997. Methane production by steers on pasture. *Can. J. Anim. Sci.* 77, 519–524.

McCaughey, W.P, Wittenberg K & Corrigan, D, 1999. Impact of pasture type on methane production by lactating beef cows. *Can. J. Anim. Sci.* 79, 221–226.

Mc Geough, E, O’Kiely, P, Hart, K.J, Foley, P.A, Boland, T.M & Kenny, D. A, 2010. Methane emissions, feed intake and performance of finishing beef cattle offered maize silages harvested at 4 different stages of maturity. *J. Anim. Sci.* 88(4), 1479-1491.

McGeough, E.J, O’Kiely, P, Hart, K.J, Moloney, A.P, Boland, T.M & Kenny, D.A, 2010. Methane emissions, feed intake, performance, digestibility, and rumen fermentation of finishing beef cattle offered whole-crop wheat silages differing in grain content. *J. Anim. Sci.* 88, 2703–2716.

McGinn, S.M, Beauchemin, K.A, Iwaasa, A.D & McAllister T.A, 2006. Assessment of the sulfur hexafluoride (SF<sub>6</sub>) tracer technique for measuring enteric methane emissions from cattle. *J. Environ. Qual.* 35, 1686–1691.

McGinn, S.M, Chung, Y-H, Beauchemin, K.A, Iwaasa, A.D & Grainger, C, 2009. Use of corn distillers’ dried grains to reduce enteric methane loss from beef cattle. *Can. J. Anim. Sci.* 89, 409–413.

McNaughton, L.R, Berry, D.P, Clark, H, Pinares-Patino, C, Harcourt, S & Spelman, R.J, 2005. Factors affecting methane production in Friesian × Jersey dairy cattle. *Proc. NZ Soc. Anim. Prod.* 65, 352–355.

Mieres, J, Olivera, L, Martino, D, La Manna, A, Fernández, E, Palermo, R & Gremminger, H, Methane emissions from Holstein heifers grazing contrasting pastures in Uruguay. [www.inia.org.uy/disciplinas/agroclima/publicaciones/ambiente/methane\\_uruguay.pdf](http://www.inia.org.uy/disciplinas/agroclima/publicaciones/ambiente/methane_uruguay.pdf)

Moate, P.J, Williams, S.R.O, Grainger, C, Hannah, M.C, Ponnampalam, E.N & Eckard, R.J, 2011. Influence of cold-pressed canola, brewers grains and hominy meal as dietary supplements suitable for reducing methane emissions from lactating dairy cows. *Anim. Feed Sci. Tech.* 166-167, 254-264.

Moate, P.J, Williams, S.R.O, Ribaux, B.E & Wales W.J, 2012. Feeding grape marc to dairy cows suppresses methane emissions. Proc. of the 5th Australasian Dairy Science Symposium 2012, 454-455.



Moate, P.J, Williams, S.R.O, Deighton, M.H & Hannah, M.C, 2013. Rate of release of SF<sub>6</sub> from permeation tubes is described by Michaelis-Menten kinetics. *Adv. Anim. Biosci.* 4:421.

Molano, G & Clark, H, 2008. The effect of level of intake and forage quality on methane production by sheep. *Aust. J. Exp. Agric.* 48, 219–222.

Molano, G, Knight, T.W & Clark, H, 2008. Fumaric acid supplements have no effect on methane emissions per unit of feed intake in wether lambs. *Aust. J. Exp. Agric.* 48, 165–168.

Morgavi, D.P, Jouany, J.P & Martin, C, 2008. Changes in methane emission and rumen fermentation parameters induced by refaunation in sheep. *Aust. J. Exp. Agric.* 48, 69–72.

Mosoni, P, Martin, C, Forano, E & Morgavi, D.P, 2011. Long-term defaunation increases the abundance of cellulolytic ruminococci and methanogens but does not affect the bacterial and methanogen diversity in the rumen of sheep. *J. Anim. Sci.* 89, 783–791.

Muñoz, C, Yan, T, Wills, D.A, Murray, S & Gordon, A.W, 2012. Comparison of the sulfur hexafluoride tracer and respiration chamber techniques for estimating methane emissions and correction for rectum methane output from dairy cows. *J. Dairy Sci.* 95, 3139-3148.

Nelson, M.L, Westberg, H.H & Parish, S.M, 2001. Effects of tallow on the energy metabolism of wethers fed barley finishing diets. *J. Anim. Sci.* 79, 1892-1904.

Neto, G.B, Berndt, A, Nogueira, J.R, Demarchi, J.J.A.A & Nogueira, J.C, 2009. Monensin and protein supplements on methane production and rumen protozoa in bovine fed low quality forage. *South African J. Anim. Sci.* 2009, 39, 280-283.

Ominski, K.D, Boadi, D.A & Wittenberg, K.M, 2006. Enteric methane emissions from backgrounded cattle consuming all-forage diets. *Can. J. Anim. Sci.* 86(3), 393-400.

O'Neill, B.F, Deighton, M.H, O'Loughlin, B.M, Galvin, N, O'Donovan, M & Lewis, E, 2012. The effects of supplementing grazing dairy cows with partial mixed ration on enteric methane emissions and milk production during mid to late lactation. *J. Dairy Sci.* 95, 6582-6590.

O'Neill, B.F, Deighton, M.H, O'Loughlin, B.M, Mulligan, F.J, Boland, T.M, O'Donovan, M & Lewis, E, 2011. Effects of a perennial ryegrass diet or total mixed ration diet offered to spring-calving Holstein-Friesian dairy cows on methane emissions, dry matter intake, and milk production. *J. Dairy Sci.* 94, 1941-1951.

O'Neill, B.F, Deighton, M.H, O'Loughlin, B.M, Mulligan, F.J, O'Donovan, M & Lewis, E, 2010. Evaluation of methane emissions by spring calving Holstein Friesian dairy cows offered a grass only diet or a total mixed ration. *Advances in Animal Biosciences*, 1, 77-77.



Pavao-Zuckerman, M.A, Waller, J.C, Ingle, T & Fribourg, H.A, 1999. Methane emissions of beef cattle grazing tall fescue pastures at three levels of endophyte infestation. *J. Environ. Qual.* 28, 1963–1969.

Pedreira, M.d.S, Primavesi, O, Lima, M.A, Frighetto, R, de Oliveira, S.G & Berchielli, T.T, 2009. Ruminal methane emission by dairy cattle in southeast Brazil. *Sci. Agric.* 66, 742–750.

Petrie, K.J, Boland, T.M, Hart, K.J, McCarney, C.M, Waters, S.M & Kenny, D.A, 2010. Effect of level of dietary soy oil supplementation and concentrate to forage ratio on feed intake, methane production and rumen fermentation variables of beef steers. *Advances in Animal Biosciences*, 1, 50-50.

Pinares-Patiño, C.S, Baumont, R & Martin, C, 2003. Methane emissions by Charolais cows grazing a monospecific pasture of timothy at four stages of maturity. *Can. J. Anim. Sci.* 83, 769–777.

Pinares-Patiño, C.S & Clark, H, 2008. Reliability of the sulfur hexafluoride tracer technique for methane emission measurement from individual animals: an overview. *Aust. J. Exp. Agric.* 48, 223–229.

Pinares- Patiño, C.S & Clark, H, 2010. Rumen function and digestive parameters associated with methane emissions in dairy cows. Proc. of the 4th Australasian Dairy Science Symposium 2010, 86-93.

Pinares-Patiño, C.S, D'Hour, P, Jouany, J.P & Martin, C, 2007. Effects of stocking rate on methane and carbon dioxide emissions from grazing cattle. *Agric. Ecosyst. Environ.* 121, 30–46.

Pinares-Patiño, C.S, Gere, J, Williams, K, Gratton, R, Juliarena, P, Molano, G, MacLean, S, Sandoval, E, Taylor G & Koolaard, J, 2012. Extending the collection duration of breath samples for enteric methane emission estimation using the SF<sub>6</sub> tracer technique. *Animal* 2, 275-287.

Pinares-Patiño, C.S, Holmes, C.W, Lassey, K.R & Ulyatt, M.J, 2007. Evaluation of the sulphur hexafluoride tracer technique for methane emission measurement in forage-fed sheep. *Proc. N.Z Soc. Anim. Prod.* 67, 431–435.

Pinares-Patiño, C.S, Holmes, C.W, Lassey, K.R & Ulyatt, M.J, 2008. Measurement of methane emission from sheep by the sulphur hexafluoride tracer technique and by the calorimetric chamber: failure and success. *Animal* 2, 141–148.

Pinares-Patiño, C.S, Lassey, K.R, Martin, R.J, Molano, G, Fernandez, M, MacLean, S, Sandoval, E, Luo, D & Clark, H, 2011. Assessment of the sulphur hexafluoride (SF<sub>6</sub>) tracer technique using respiration chambers for estimation of methane emissions from sheep. *Anim. Feed Sci. Technol.* 166–167, 201–209.

Pinares-Patiño, C.S, Machmüller, A, Molano, G, Smith, A, Vlaming, J.B & Clark, H, 2008. The SF<sub>6</sub> tracer technique for measurements of methane emission from cattle — effect of tracer permeation rate. *Can. J. Anim. Sci.* 88, 309–320.

Pinares-Patiño, C.S, Molano, G, Smith, A & Clark, H, 2008. Methane emissions from dairy cattle divergently selected for bloat susceptibility. *Aust. J. Exp. Agric.* 48, 234–239.

Pinares-Patiño, C.S, Ulyatt, M.J, Lassey, K.R, Barry, T.N & Holmes, C.W, 2003. Rumen function and digestion parameters associated with differences between sheep in methane emissions when fed chaffed lucerne hay. *J. Agric. Sci.* 140, 205–214.

Pinares-Patiño, C.S, Ulyatt, M.J, Lassey, K.R, Barry, T.N & Holmes, C.W, 2003. Persistence of differences between sheep in methane emission under generous grazing conditions. *J. Agric. Sci.* 140, 227–233.

Pinares-Patiño, C.S, Ulyatt, M.J, Waghorn, G.C, Lassey, K.R, Barry, T.N, Holmes, C.W, Johnson, D.E, 2003. Methane emission by alpaca and sheep fed on lucerne hay or grazed on pastures of perennial ryegrass/white clover or birdsfoot trefoil. *J. Agric. Sci.* 140, 215–226.

Pinares-Patiño, C.S, Waghorn, G.C, Machmüller, A, Vlaming, B, Molano, G, Cavanagh, A & Clark, H, 2007. Methane emissions and digestive physiology of non-lactating dairy cows fed pasture forage. *Can. J. Anim. Sci.* 87, 601–613.

Popova M, Martin C, Eugène M, Mialon M.M, Doreau M & Morgavi D. P, 2011. Effect of fibre- and starch-rich finishing diets on methanogenic Archaea diversity and activity in the rumen of feedlot bulls. *Anim. Feed Sci. Technol.* 166-167, 113-121.

Ramírez-Restrepo, C.A, Barry, T.N, Marriner, A, Lopez-Villalobos, N, McWilliam, E.L, Lassey, K.R & Clark, H, 2010. Effects of grazing willow fodder blocks upon methane production and blood composition in young sheep. *Anim. Feed Sci. Technol.* 155, 33–43.

Rochette, Y, Eugène, M, Doreau, M, Morgavi, D.P & Martin, C, 2012. Determination of enteric methane emission by SF<sub>6</sub> tracer technique: Permeation tubes must be calibrated after incubation in the rumen for an accurate quantification. The International Symposium on Emissions of Gas and Dust from Livestock, Saint-Malo, France, June 10-13, 2012.

Rowntree, J.D, Pierce, K.M, Buckley, F, Callan, J.J, Kenny, D.A & Boland, T.M, 2010. Effect of either soya or linseed oil supplementation of grazing dairy cows on milk production and methane emissions. *Advances in Anim. Biosciences*, 1, 51-51.

Sejian, V, Lal, R, Lakritz, J & Ezeji, T, 2011. Measurement and prediction of enteric methane emission. *Int. J. Biometeorol.* 55, 1–16.

Stewart, A.A, Undi, M, Wilson, C, Ominski, K.H & Wittenberg, K.M, 2008. Estimation of carbon dioxide production and energy expenditure of grazing cattle by the sulphur hexafluoride (SF<sub>6</sub>) tracer gas technique. *Can. J. Anim. Sci.* 88, 651–658.

Swainson, N, Brookes, I, Hoskin, S & Clark, H, 2011. Variability of SF<sub>6</sub> and CH<sub>4</sub> gas concentrations in the breath samples of sheep and cattle: defining criteria for the systematic exclusion of data when using the SF<sub>6</sub> tracer technique to measure CH<sub>4</sub> emissions. 8th Int. Sym. Nut. Herb. Aberystwyth, Wales, UK.

Swainson, N.M, Brookes, I.M, Hoskin, S.O & Clark, H, 2011. Post-experiment correction for release rate in permeation tubes improves the accuracy of the sulphur hexafluoride (SF<sub>6</sub>) tracer technique in deer. *Anim. Feed Sci. Technol.* 166–167, 192–197.

Swainson, N.M, Hoskin, S.O, Clark, H & Lopez-Villalobos, N, 2007. The effect of age on methane emissions from young, weaned red deer (*Cervus elaphus*) stags grazing perennial-ryegrass (*Lolium perenne*)-based pasture. *NZ J. Agric. Res.* 50, 407–416.

Tavendale, M.H & Klein, L, 2003. Discovering the origin of the SF<sub>6</sub> tracer based methane emission variances, In: Echardt, R, Slattery, B (Eds.) 2nd Joint Australia and New Zealand Forum on Non-CO<sub>2</sub> Greenhouse Gas Emissions from Agriculture, Cooperative Research Centre for Greenhouse Gas Accounting, Canberra, Australia, pp. D6.

Tekippe, J.A, Hristov, A.N, Heyler, K.S, Cassidy, T.W, Zheljzkov, V.D, Ferreira, J.F.S, Karnati, S.K & Varga, G.A, 2011. Rumen fermentation and production effects of *Origanum vulgare* L. leaves in lactating cows. *J. Dairy Sci.* 94, 5065-5079.

Ulyatt, M.J, Baker, S.K, McCrabb, G.J & Lassey, K.R, 1999. Accuracy of SF<sub>6</sub> tracer technology and alternatives for field measurements. *Aust. J. Agric. Res.* 50, 1329–1334.

Ulyatt, M.J, Lassey, K.R, Martin, R.J, Walker, C.F & Shelton, I.D, 1997. Methane emission from grazing sheep and cattle. *Proc. NZ Soc. Animal Prod.* 57, 130-133.

Ulyatt, M.J, Lassey, K.R, Shelton, I.D & Walker, C.F, 2002. Seasonal variation in methane emission from dairy cows and breeding ewes grazing ryegrass/white clover pasture in New Zealand. *NZ J. Agric. Res.* 45, 217–226.

Ulyatt, M.J, Lassey, K.R, Shelton, I.D & Walker, C.F, 2002. Methane emission from dairy cows and wether sheep fed sub-tropical grass-dominant pastures in mid summer in New Zealand. *NZ J. Agric. Res.* 45, 227–234.

Ulyatt, M.J, Lassey, K.R, Shelton, I.D & Walker, C.F, 2005. Methane emission from sheep grazing four pastures in late summer in New Zealand. *NZ J. Agric. Res.* 48, 385–390.

Van der Werf, H.M.G, Martin, C & Doreau, M, 2010. Environmental impact of three high-concentrate diets fed to bulls. *Advances in Animal Biosciences*, 1, 71-71.

Vlaming, J.B, Brookes, I.M, Hosking, S.O, Pinares-Patiño & C.S, Clark, H, 2007. The possible influence of intra-ruminal sulphur hexafluoride release rates on calculated methane emissions from cattle. *Can. J. Anim. Sci.* 87, 269–275.

Vlaming, J.B, Clark, H & Lopez-Villalobos, N, 2005. The effect of SF release rate, Animal species and feeding conditions on estimates of methane emissions from ruminants. *Proceedings of the New Zealand Society of Animal Production 2005*, Vol 65.

Vlaming, J.B, Lopez-Villalobos, N, Brookes, I.M, Hoskin, S.O & Clark, H, 2008. Within- and between-animal variance in methane emissions in non-lactating dairy cows. *Aust. J. Exp. Agric.* 48, 124–127.

Waghorn, G.C, Clark, H, Taufu, V & Cavanagh, A, 2008. Monensin controlled-release capsules for methane mitigation in pasture-fed dairy cows. *Aust. J. Exp. Agric.* 48, 65–68.

Westberg, H, Lamb, B, Johnson, K.A & Huyler, M, 2001. Inventory of methane emissions from U.S. cattle. *J. Geophysical Res.* 106, 12633–12642.

Williams, S.R.O, Moate, P.J, Hannah, M.C, Ribaux, B.E, Wales, W.J & Eckard, R.J, 2011. Background matters with the SF<sub>6</sub> tracer method for estimating enteric methane emissions from dairy cows: A critical evaluation of the SF<sub>6</sub> procedure. *Anim. Feed Sci. Technol.* 170, 265–276.

Wims, C, Deighton, M, Lewis, E, O'Loughlin, B, Delaby, L, Boland, T.M & O'Donovan, M, 2010. Effect of pre-grazing herbage mass on methane production, dry matter intake and milk production of grazing dairy cows during the mid season period. *J. Dairy Sci.* 93, 4976–4985.

Woodward, S.L, Waghorn, G.C & Laboyrie, P.G, 2004. Condensed tannins in birdsfoot trefoil (*Lotus corniculatus*) reduce methane emissions from dairy cows. *Proc. NZ Soc. Anim. Prod.* 64, 160–164.

Woodward, S.L, Waghorn, G.C, Lassey, K.R & Laboyrie, P.G, 2002. Does feeding sulla (*Hedysarum coronarium*) reduce methane emissions from dairy cows? *Proc. NZ Soc. Anim. Prod.* 62, 227–230

Woodward, S.L, Waghorn, G.C & Thomson, N.A, 2006. Supplementing dairy cows with oils to improve performance and reduce methane — does it work? *Proc. NZ Soc. Anim. Prod.* 66, 176–181.

Woodward, S.L, Waghorn, G.C, Ulyatt, M.J & Lassey, K.R, 2001. Early indications that feeding Lotus will reduce methane emissions from ruminants. *Proc. NZ Soc. Anim. Prod.* 61, 23–26.

Wright, A.D.G, Kennedy, P, O'Neill, C.J, Toovey, A.F, Popovski, S, Rea, S, Pimm, S.M & Klein, L, 2004. Reducing methane emissions in sheep by immunization against rumen methanogens. *Vaccine*, 22, 3976–3985.

Zhou, M, Chung, Y-H, Beauchemin, K.A, Holtshausen, L, Oba, M, McAllister & T.A, Guan, L.L, 2011. Relationship between rumen methanogens and methane production in dairy cows fed diets supplemented with a feed enzyme additive. *J. Applied Microbiol*, 111, 1148-1158.

Zimmerman, P. 1993. U.S. Patent 5265618, "System for Measuring Metabolic Gas Emissions from Animals", U.S. Patent and Trademark Office, November 30th, 1993.