



HAL
open science

Fire Paradox Fuel Manager: user's manual (final version). Final product P6.1-6 of the integrated project "Fire Paradox"

Isabelle Lecomte, Francois F. Rouault de Coligny, Sébastien Griffon, François Pimont, Eric Rigaud, Eric Rigolot, Oana Vigy

► **To cite this version:**

Isabelle Lecomte, Francois F. Rouault de Coligny, Sébastien Griffon, François Pimont, Eric Rigaud, et al.. Fire Paradox Fuel Manager: user's manual (final version). Final product P6.1-6 of the integrated project "Fire Paradox". FP6-018505, 2010. hal-02823224

HAL Id: hal-02823224

<https://hal.inrae.fr/hal-02823224>

Submitted on 6 Jun 2020

HAL is a multi-disciplinary open access archive for the deposit and dissemination of scientific research documents, whether they are published or not. The documents may come from teaching and research institutions in France or abroad, or from public or private research centers.

L'archive ouverte pluridisciplinaire **HAL**, est destinée au dépôt et à la diffusion de documents scientifiques de niveau recherche, publiés ou non, émanant des établissements d'enseignement et de recherche français ou étrangers, des laboratoires publics ou privés.



Project no. FP6-018505

Project Acronym FIRE PARADOX

Project Title FIRE PARADOX: An Innovative Approach of Integrated Wildland Fire Management Regulating the Wildfire Problem by the Wise Use of Fire: Solving the Fire Paradox

Instrument Integrated Project (IP)

Thematic Priority Sustainable development, global change and ecosystems

**DELIVERABLE AND PRODUCT P6.1-6
FIRE PARADOX FUEL MANAGER: SOFTWARE AND USER'S MANUAL
(FINAL VERSION)**

Due date of deliverable: Month 47

Start date of project: 1st March 2006

Duration: 48 months

Organization name of lead contractor for this deliverable: INRA

Revision (1000)

Project co-funded by the European Commission within the Sixth Framework Programme (2002-2006)		
Dissemination Level		
PU	Public	
PP	Restricted to other programme participants (including the Commission Services)	X
RE	Restricted to a group specified by the consortium (including the Commission Services)	
CO	Confidential, only for members of the consortium (including the Commission Services)	

Authors and contribution partners:

- P02-INRA-URFM, Avignon, France: Isabelle Lecomte, François Pimont, Eric Rigolot, Oana Vigy
- INRA-AMAP, Montpellier, France: François de Coligny, Sébastien Griffon
- ARMINES, Sophia Antipolis, France: Eric Rigaud

Reference

Lecomte, I., de Coligny, F., Griffon, S., Pimont, F., Rigaud, E., Rigolot, E., Vigy, O. 2010. Fire Paradox Fuel Manager: User's manual Final Product P6.1-6 of the Integrated project "Fire Paradox", Project no. FP6-018505, European Commission, 93 p.

Download link

Fire Paradox Fuel Manager software (capsis-4.2.2-fireparadox-setup_Feb2010.jar) can be downloaded from the Fire Paradox Fire Intuition platform at <http://www.fireintuition.efi.int>

Executive summary

The *FIRE PARADOX FUEL MANAGER* is computer software integrated in the data processing chain between the European data and knowledge base on fuels (*FIRE PARADOX FUEL* database) and the 3D physical-based fire propagation models. The scientific objective is the representation of vegetation scenes and their transformation into fuel complexes including all the necessary parameters to run a fire behaviour model. The technological objectives are to implement a user friendly platform to generate fuel complexes in 3D, to provide tools for managing the *FIRE PARADOX FUEL* database, to visualize fire effects on trees and simulate post fire vegetation successions.

A survey of available simulation platform technologies has led us to join the *CAPSIS* project, dedicated to hosting a wide range of models for forest dynamics and stand growth. A new *CAPSIS* module – "*Fire Paradox*" – has been developed which implements data structure and functionalities of the *FIRE PARADOX FUEL MANAGER*.

A 3D vegetation scenes' editor has been implemented allowing interactive manipulative functionalities on vegetation scenes (e.g. zoom, rotation, etc) as well as on vegetation objects (selecting, adding, updating) through a graphical user interface. Several renderers are available to display 3D vegetation objects. Fire damage on vegetation objects have been mainly focused on fire-induced tree mortality. Several fire impacts on trees crown and trunk have been defined and can be visualized at the scene scale. Moreover, several tools are available to display information (descriptive statistics, indicators) on the vegetation scene content or on the current selection.

Several creation modes of vegetation scenes are available including loading of a pre-existing inventory file or the automatic generation of a new scene respecting a set of constraints on species distribution.

The application is connected through the Internet to the *FIRE PARADOX FUEL* database and manages the users' rights. *FIRE PARADOX FUEL* database is hosted by P05-EFI server in Finland being a facility of the *FIREINTUITION* platform.

An export module has been developed to prepare the set of files necessary to run the fire propagation model *FIRETEC*. Export files describe the composition and the structure of the fuel complexes taking into account the physical properties of various components of the different vegetation layers (trees, shrubs, herbs and litter) composing the vegetation scene.

CONTENTS LIST

CONTENTS LIST	3
ACRONYMS	7
GLOSSARY	8
1 INTRODUCTION	10
1.1 Fuel manager	10
1.2 The Fuel Database	10
2 TERMINOLOGY AND CONCEPTS	11
2.1 Session, project, module, scenario	11
2.2 Extensions	11
2.3 Objects	11
2.4 Taxonomic Levels	11
2.5 Shape Pattern	12
3 INSTALLATION AND CONFIGURATION	14
3.1 Java Runtime Environment installation	14
3.2 Install & Start <i>CAPSIS</i>	14
3.2.1 Download and Install	15
3.2.2 Launch the CAPSIS Platform	15
4 USE OF THE <i>FIRE PARADOX FUEL MANAGER</i> – OVERVIEW	16
4.1 Screen Layouts	17
4.1.1 CAPSIS Screen Layout	17
4.1.2 Module <i>Fire Paradox</i> Screen Layout	17
4.2 Keyboard Shortcuts	19
4.3 Program Help	20
5 VEGETATION SCENE CREATION	21
5.1 CAPSIS project creation	21
5.2 Vegetation scene creation	22
5.3 From a database inventory	22

5.4	From a detailed Inventory File	22
5.4.1	For Viewing Only	22
5.4.2	From POP COV files	23
5.4.3	From POP COV files Full Dialog	23
5.4.4	For Matching with Database	24
5.5	From Field Parameters	24
5.6	From Scratch	24
5.7	From Saved Scene	24
6	VEGETATION SCENE MODIFICATION	25
6.1	Selection	25
6.1.1	Individual or Multiple Selection	25
6.1.2	Unselection	25
6.1.3	Selection with the Scene Inspector	26
6.2	Adding	26
6.2.1	Item choice: Vegetation Objects Selection	27
6.2.2	Spatialisation: Planting Method Process	29
6.2.3	Adding a Polygon or a Polyline	31
6.3	Updating	32
6.3.1	Moving Functionality	32
6.3.2	Deleting Functionality	32
7	VEGETATION SCENE VISUALISATION	33
7.1	Viewpoint Motions	33
7.1.1	Orbit Functionality	33
7.1.2	Zoom Functionality	33
7.1.3	Pan Functionality	33
7.2	Object Renderers	34
7.2.1	Renderers Dialog Windows	34
7.2.2	Pattern Sketcher Render	35
7.2.3	Degraded modes for heavy scene manipulation	36
8	VEGETATION SCENE ANALYSIS	37
8.1	Descriptive Analysis on the whole set of Vegetation Objects	37
8.2	Descriptive Analysis on Selected Vegetation Objects	38
8.3	Visual Analysis	38
8.4	Effects of Fire Visualisation	39
8.4.1	Crown Damages visualisation	39
8.4.2	Bole Damages visualisation	39
8.5	Visualisation Options	40
9	PATTERNS' EDITOR	41

9.1	Screen Layout	41
9.2	Association: Shape Pattern linked to a Group of Vegetation Objects	42
9.2.1	Create an Association	43
9.2.2	Update an Association	43
9.2.3	Remove an Association	43
9.3	Shape Patterns	44
9.3.1	Shape Patterns Dialog Windows	44
9.3.2	Create a Shape Pattern	45
9.3.3	Update a Shape Pattern	45
9.3.4	Delete a Shape Pattern	45
10	STAND EVOLUTION AND INTERVENTIONS	46
10.1	Project configuration, saving and opening	47
10.2	Groups	47
10.3	Stand intervention	48
10.3.1	Interventions	48
10.3.2	Fire perturbation	48
10.3.2.1	<i>Fire damage to cambium (empirical models implemented)</i>	<i>50</i>
10.3.2.2	<i>Fire damage to crown</i>	<i>51</i>
10.3.2.3	<i>Tree mortality</i>	<i>52</i>
10.4	Session saving and opening	54
11	FIRE MODELS EXPORTATION	55
11.1	<i>FIRETEC</i> Model	55
11.2	Exportation procedure	55
12	FIRE PARADOX FUEL DATABASE MANAGER	58
12.1	Database Connection and User Rights	58
12.2	Available functionalities: main menu	58
12.3	Teams' Editor (Administrator rights)	59
12.3.1	Teams' List	59
12.3.2	Create a new Team	59
12.3.3	Update a team	60
12.3.4	Desactivate a Team	60
12.3.5	Reactivate a Team	61
12.4	Teams' Editor (Team rights)	61
12.5	Sites' Editor	62
12.5.1	Sites' List	62
12.5.2	Create or Update a Site	62
12.5.3	Manage site events	64
12.5.4	Desactivate a Site	65
12.5.5	Reactivate a Site	65
12.5.6	Municipalities' List	65
12.5.7	Create or Update a Municipality	66

12.5.8	Deactivate a Municipality	66
12.5.9	Reactivate a Municipality	67
12.6	Fuels' Editor (Fuel Plants)	67
12.6.1	Fuel Plants' List	67
12.6.2	Create or Update a Plant	68
12.6.3	Shapes creation for a measured plant	71
12.6.3.1	<i>Sample creation for a measured plant (cube method)</i>	71
12.6.3.2	<i>2D shape creation for a measured plant (cube method)</i>	73
12.6.3.3	<i>2 * 2D shape creation for a measured plant (cube method)</i>	74
12.6.3.4	<i>3D shape creation for a measured plant (cube method)</i>	75
12.6.3.5	<i>Sample creation for a measured plant (cage method)</i>	77
12.6.3.6	<i>3D shape creation for a measured plant (cage method)</i>	78
12.6.4	Create shapes for a virtual plant	78
12.6.5	Create or Update Plant Particles Parameters	78
12.6.6	Deactivate a plant	79
12.6.7	Reactivate a plant	79
12.7	FuelEditors (allometric approach for trees)	79
12.7.1	Crown envelope	80
12.7.2	Thin biomass	80
12.8	Fuel Editor (Fuel Layers)	82
12.8.1	Fuel Layers' List	82
12.8.2	Create or Update a Fuel Layer	84
12.8.3	Create shapes for a layer	84
12.8.3.1	<i>Sample creation for a layer</i>	84
12.8.3.2	<i>2D shape creation for a layer</i>	84
12.8.4	Create or Update layer Particles Parameters	85
12.8.5	Deactivate a layer	86
12.8.6	Reactivate a layer	86
12.9	Fuel Editor (Fuel samples)	86
12.9.1	Fuel Samples' list	87
12.9.2	Deactivate a sample	87
12.9.3	Reactivate a sample	87
13	REFERENCES	88
14	ANNEX	90
14.1	Annex – Inventory Files	90
14.2	Annex – Chain between Patterns' Editor GUIs	93

ACRONYMS

2D	Two dimensions ; 3D	Three dimensions
AC	Ash Content (g/100g)	
AMAP	botAnique et bioInforMatique de l'Architecture des Plantes	
DLL	Dynamic Link Library	
DTM	Digital Terrain Model	
PPFM	Fire Paradox Fuel Manager	
GUI	Graphical User Interface	
INRA	Institut National de la Recherche Agronomique (Fire Paradox partner 02)	
JAR	Java Archive	
JRE	Java Runtime Environment	
MVR	Mass-to-Volume Ratio (ρ)	
SLA	Specific Leaf Area of the leaves (m^2/kg)	
SVR	Surface-to-Volume Ratio (σ)	
VF	Volume Fraction (α)	
WSL	Wald, Schnee und Landschaft (Fire Paradox partner 13)	

GLOSSARY

Cage method: fuel description method expanded from the cube method (see below) in order to fit with plants of large dimensions. Fuel particles' biomass is measured in each voxel of a 3D grid.

Cube method: fuel description method designed by the Fire Star European project and consolidated by the Fire Paradox project to model the spatial distribution of fuel particles as required by physically based fire models [1].

Grid: set of lines dividing the ground surface in squares. Grid can be useful to locate vegetation objects in the vegetation scene.

Fuel family: a fuel family represents all the solid particles of vegetation, which have the same properties concerning physical, chemical and thermal processes involved in wildfire propagation. Typical fuel families are needles, leaves or twigs of several diameters.

Fuel sample: sample of fuel of a lower level than a vegetation object (individual plant). One or several fuel samples are necessary to build a vegetation object (See Figure 1). Fuel sampling is generally carried out with the so called "cube" method (see above), collecting fuel in elementary volumes of 25 cm side. Consequently a typical fuel sample is a 25 cm x 25 cm x 25 cm voxel, although it may have other dimensions. A fuel sample may be collected by field destructive measurements (measured), or calculated.

Layer

Vegetation layer: layer composed of all the plants occupying the same vegetation stratum: trees, shrubs and grasses layers are the main layers considered in this document. Litter can be considered as a layer as well, but it is composed of downed and dead woody debris.

Fuel Layer: collection of individual plants, closely grouped and difficult to describe separately, forming a layer generally much more wide than high. A fuel layer is described as a single vegetation object and has almost the same properties than an individual plant. Each Fuel Layer is described with its own macroscopic properties, including bulk density, LAI, moisture, cover fraction and characteristic size of clumps. *Quercus coccifera* shrubland is a typical fuel layer.

Fuel LayerSets: A Fuel LayerSet is a polygon which contains different fuel layers, which represent each fuel type included in the Fuel LayerSet. For example, a Fuel LayerSet of garrigue, can contain 3 layers: *Quercus coccifera*, *Rosmarinus officinalis* and *Brachypodium retosum*.. Fuel layers correspond to a fuel complex where few information is available on the position of the individual fuel type inside of it or when the user wants to summarize them in a unique object. It is generally used to represent understorey, but can be also used to represent canopies.

Object: (*Sensus CAPSIS*) elements composing a scene such as a terrain, a grid, polygons, polylines or vegetation objects (in other word item).

Plant: vegetation object

Measured plant: vegetation object corresponding to a real plant measured in the field.

Virtual plant: vegetation object not corresponding to real plant measured in the field. It may differ either by its shape, by the distribution of cubes within its shape, by the values of one or several fuel parameters (*e.g.* mean of several samples).

Renderer: (Computer science term) graphical way to represent a 3D object. *FIRE PARADOX FUEL MANAGER* proposes several renderers to visualise Objects (terrain, grid and vegetation objects).

Terrain: ground surface of a vegetation stand. It may be flat or may follow the ground surface topography through a Digital Elevation Model (DEM). This object is necessary to display vegetation objects.

Shape pattern: characterization of the crown envelope of a vegetation object by defining the ratios between the different horizontal stratifications of the crown.

Site: location where destructive fuel sampling has been carried out to characterize individual plant or particle fuel properties.

Taxon: a **taxon** (plural **taxa**), is a name applied for an organism or a group of organisms. In biological nomenclature according to Carl Linnaeus, a taxon is assigned to a taxonomic rank and can be placed at a particular level in a systematic hierarchy reflecting evolutionary relationships.

Team: Fire Paradox partner involved in fuel description field and laboratory works.

Vegetation object: individual plant (tree, shrub, grass) or fuel layer represented on the vegetation scene and fully described as a fuel in the *FIRE PARADOX FUEL* database.

Vegetation scene: collection of vegetation objects organized on a landscape including possibly different vegetation layers (trees, shrubs, grasses and litter).

Voxel: Elementary volume for fuel description. It is generally, but not necessarily, a volume of 25 cm side. A voxel is part of the fuel sample collected in the field when using the cube method (see Fuel sample).

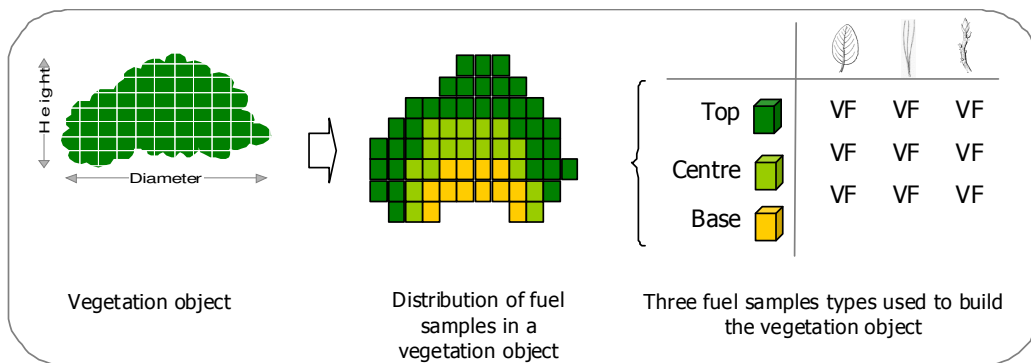

Figure 1: Vegetation object built with 3 types of fuel samples

1 INTRODUCTION

This document presents the functionalities of the application identified as an Integrated Product under the name "*FIRE PARADOX FUEL MANAGER (FPFM)*". This application results from the activities of **WP6.1** "*Design, development, test and deployment of a fuel editor*" within the Fire Paradox project.

The main goal of the *FIRE PARADOX FUEL MANAGER* is to generate – with a user friendly manner – fuel complexes in 3D in order to be used as input data for fire behaviour models. These input files describe the composition and the structure of the fuel complex taking into account the physical properties of various components of the different vegetation layers (trees, shrubs, herbs and litter) composing the vegetation scene.

The *FIRE PARADOX FUEL MANAGER* also provides tools for managing a fuel database: adding, updating and deleting fuels descriptions (location and dimension of vegetation objects and fuel parameters for fire simulations).

The *FIRE PARADOX FUEL MANAGER* is also enabling to visualise effects of fire on trees and to simulate vegetation succession after fire occurrence.

1.1 Fuel manager

The *FIRE PARADOX FUEL MANAGER* aims to be, on one hand, a management tool for manipulating fuel complexes and on the other hand, an application that enables fire simulations and the generation of vegetation post fire succession steps. A survey of available technologies has identified a simulation platform, [Capsis](#) [2][3], dedicated to hosting a wide range of models for forest dynamics and stand growth. *CAPSIS* is a project led by a joint research unit INRA-AMAP (Montpellier, France). In a few words, *CAPSIS* is designed around a kernel which provides an organizational data structure (session, project, scenario steps) and also generic data descriptions (stand, tree, etc.). These descriptions can be completed in modules – one for each model – which implement a proper data structure and a specific evolution function (growth, mortality, regeneration, etc.) with a chosen simulation step.

The *FIRE PARADOX FUEL MANAGER* development team decided to join the *CAPSIS* project to benefit from this practical, scalable and free platform which is adapted to forestry modellers, forestry managers and education. Thus, we co-developed a new *CAPSIS* module – "*Fire Paradox*" – which implements data structure and functionalities of the *FIRE PARADOX FUEL MANAGER*.

CAPSIS and *FIRE PARADOX FUEL MANAGER* are both written in JAVA language [4].

1.2 The Fuel Database

Data related to fuel descriptions are stored in a database with the purpose of designing a European data and knowledge base on fuels (*FIRE PARADOX FUEL* database). WSL is the partner in charge of implementing the *FUEL* database in the framework of **WP3.3.4** "*Design a database for fuel and plant architecture*". The data structure has been designed in collaboration with INRA partner.

The complete database structure will be described in **D3.3-6** "*Database of fuel characteristics*" (due date month 48). The *FUEL* database is also accessible through a web interface available on the Fire Paradox Fire Intuition platform at <http://www.fireintuition.efi.int>.

2 TERMINOLOGY AND CONCEPTS

This chapter gives a list of terms used in this manual. A few concepts were already explained in the glossary and deliverable D6.1-2 "Detailed definition of the data structure and functionalities of the *FIRE PARADOX FUEL MANAGER*".

2.1 Session, project, module, scenario

Session, *project*, *module* and *scenario* are *CAPSIS* concepts. A *session* can contain several projects; so the user can open several projects in parallel. Each *project* is associated to a specific *module* chosen at the beginning. A project always contains a *root step*, supporting the *initial stand* of the simulation, either loaded from file or virtually generated. The user can create different *scenarios* by alternating growth sequences calculated by the model and silvicultural treatments.

2.2 Extensions

The simulated data can then be checked by using specific *extensions* (plug-ins) of the module or others that are compatible with: viewers, graphics, intervention methods (including thinning, pruning, fertilization, plantation, etc.) and export tools in various formats for closer analysis.

2.3 Objects

A scene can be composed of several *objects* such as a *terrain*, a *grid* and several *vegetation objects*.

A ***Terrain*** corresponds to the ground of a vegetation stand. It may be flat or may follow the ground surface topography through a Digital Elevation Model (DEM). This object is necessary to display vegetation objects.

A ***Grid*** is a set of lines dividing the ground surface in squares. Grid can be useful to locate vegetation objects in the vegetation scene.

Vegetation objects can be trees, shrubs and grasses which properties can be extracted from the *FIRE PARADOX FUEL* database or described in files.

2.4 Taxonomic Levels

Taxonomy is the science of classifying organisms. The system used in the *FIRE PARADOX FUEL* database is the Linnaean one, which breaks down organisms into seven major divisions, called *taxa* (singular: taxon). Divisions are as follow: kingdom, phylum, class, order, family, genus and species.

The classification levels become more specific towards the bottom and we will focus on the genus and species one. As example, *Quercus ilex* and *Quercus coccifera* species belong to the same genus *Quercus*.

Taxon: a **taxon** (plural **taxa**), is a name applied for an organism or a group of organisms. In biological nomenclature according to Carl Linnaeus, a taxon is assigned to a taxonomic rank and can be placed at a particular level in a systematic hierarchy reflecting evolutionary relationships.

2.5 Shape Pattern

A shape pattern characterizes the crown envelope of a vegetation object by defining the ratios between the different horizontal stratifications of the crown (Figure 2).

The following dimensions are expressed in percentage of the crown height:

- Top of the crown = 100%
- Base of the crown = 0%
- Level of the maximum crown diameter is set by the user. This dimension is used as an indicator and will be readjusted by the effective height (of the max. diameter) of the vegetation object.
- The maximum crown diameter is also defined as a percentage of the crown length.

Levels can be defined in order to adjust the form of the envelope in both horizontal and vertical directions. In that respect, the crown is divided into two parts, the upper portion (over the max. diameter level) and the lower portion (under the max. diameter level). Intermediate diameters can be added in these two portions. Each of these new diameters is described by two parameters:

- Horizontal direction: percentage of the max. diameter length
- Vertical direction: percentage of crown portion height

The Figure 2 illustrates a shape pattern which dimensions are:

- Level of the max diameter is set at 30% of the crown height.
- One intermediate crown diameter is defined at 50% of the height of the lower part of the crown.

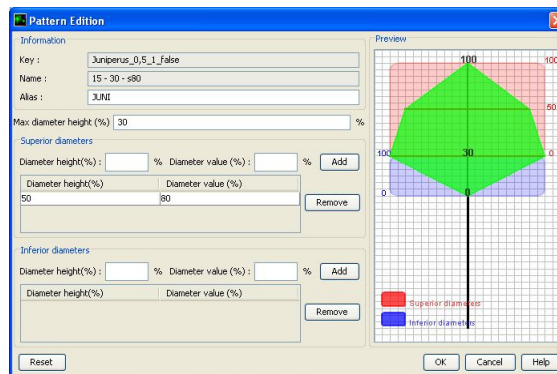

Figure 2: Shape Pattern with its dimensions

A vegetation object shape is succinctly described by its crown height, crown base height, max crown diameter height and crown diameter length.

Figure 3 shows three different vegetation objects displayed by using the same shape pattern, the one previously described in Figure 2.

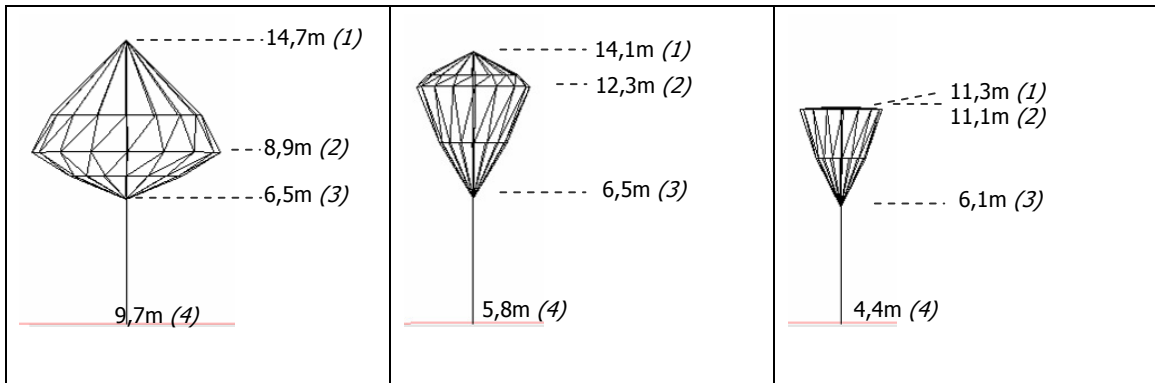

Figure 3: (1) Crown height - (2) Max diameter height - (3) Crown base height

The first shape looks like its associated shape pattern (Figure 2), but the two others have quite different aspects. It is due to one single property – the maximum crown diameter height – which differs from one vegetation object to the other. Indeed, in the three illustrations, the maximum diameter level is respectively 29%, 76% and 99% of the crown height, more or less closed to the 33% set in the shape pattern.

To date, the maximum crown diameter height is randomly generated because this property is still missing in vegetation objects description in the *FIRE PARADOX FUEL* database. This property is planned to be filled in at the same time as other vegetation object shape properties thanks to the vegetation object manipulation functionalities. The coherence between those different inputs should be then guaranteed.

3 INSTALLATION AND CONFIGURATION

The installation and configuration of three components are necessary to fully use the *FIRE PARADOX FUEL MANAGER*:

- Java Runtime Environment (JRE), version 1.6
- Module *Fire Paradox* of the *CAPSIS* platform.

Detailed instructions are given in the following chapters.

The *FIRE PARADOX FUEL MANAGER* works on Windows, Macintosh, Linux and anything else which accepts Java. Steps dedicated to the Windows operating system are stressed in this chapter as it is the most common operating system.

3.1 Java Runtime Environment installation

1- Install **Java 1.6 (j2se)** on your computer (Windows, Linux: see <http://java.sun.com/j2se/>, Mac OS X: check that Apple's Java 1.6 is installed on your machine). You need a JRE (Runtime Environment) for simple use or a JDK (Development Kit, including a java compiler) if you are a developer.

2- Ensure that your PATH contains `java_install_directory/bin/`. You can check your PATH in a new terminal by entering "java -version".

If a JRE is already installed on your computer, a checkout will indicate the running version number. Depending on the result, the required version will be installed.

In a terminal execute the following commands.

Windows

```
java -version
```

Linux / Mac OS X

```
sh java -version
```

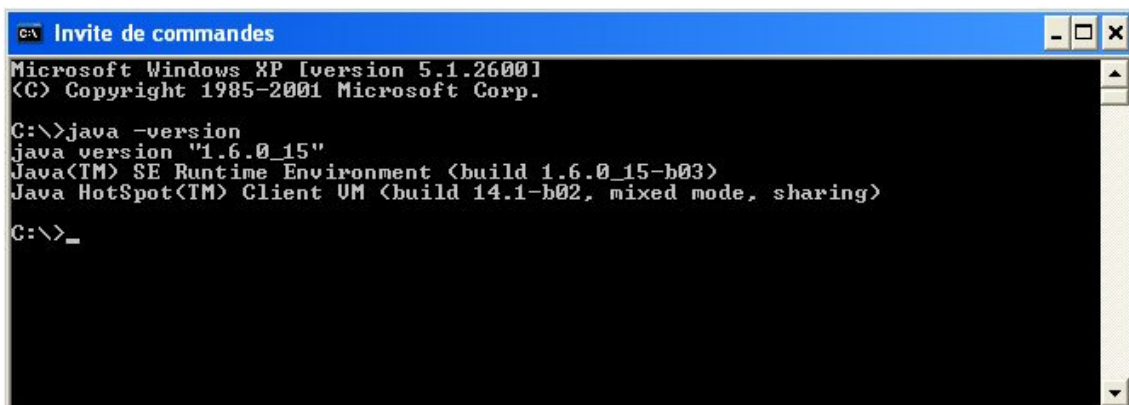

```
Microsoft Windows XP [version 5.1.2600]
(C) Copyright 1985-2001 Microsoft Corp.

C:\>java -version
java version "1.6.0_15"
Java(TM) SE Runtime Environment (build 1.6.0_15-b03)
Java HotSpot(TM) Client VM (build 14.1-b02, mixed mode, sharing)

C:\>_
```

Figure 4: Command window screenshot - java version 1.6 installed

3.2 Install & Start *CAPSIS*

CAPSIS is an open software platform which hosts a wide range of forests growth and dynamics models. The "Fire Paradox" module, which has been developed within *CAPSIS*, corresponds to the *FIRE PARADOX FUEL MANAGER*.

Many other *CAPSIS* modules exist but they are not released here. For further information, consult the *CAPSIS* website (<http://capsis.cirad.fr>).

3.2.1 Download and Install

The installation file of the *FIRE PARADOX FUEL MANAGER* software (capsis-4.2.2-fireparadox-setup_Feb2010.jar) can be downloaded from the Fire Paradox Fire Intuition platform at <http://www.fireintuition.efi.int>

- Double click on the capsis-4.2.2-fireparadox-setup_Feb2010.jar file
- Follow the instructions

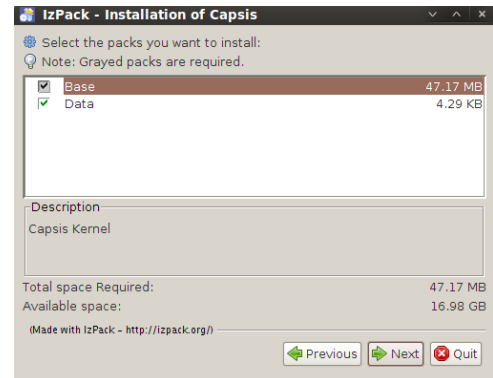

Figure 5: Installation of *CAPSIS*

On **Windows Vista**, you must choose a directory where you have write privileges (for instance *Documents*)

3.2.2 Launch the *CAPSIS* Platform

Use the **Start menu** or the **Desktop shortcut** to start capsis

Change to `capsis_install_directory\capsis4` directory and run the launcher script. *CAPSIS* is available in French and English. To launch *CAPSIS* in French, use the `-l fr` option instead of `-l en`, which stands for opening in English.

Windows

```
cd capsis_install_directory\capsis4
capsis
```

Linux

```
cd capsis_install_directory/capsis4
sh capsis.sh
```

NOTE: You can check *CAPSIS* option with the `-h` option

4 USE OF THE *FIRE PARADOX FUEL MANAGER* – OVERVIEW

In this chapter, an overview of the *CAPSIS* platform is first presented. Then, the way to use available functionalities of the *Fire Paradox* module is described.

The items represented on a 3D vegetation scene can be used to build a large variety of landscape, including zones with different fuel types. These items only contain the macroscopic properties that are required for their representation and computation of mean fuel characteristics at stand level (Table 1). These items are individual plants and Fuel LayerSets. Fuel LayerSets are composed of several Fuel Layers (Table 2).

An individual plant can be a tree or a shrub, with a few characteristics including its dimension, bulk density and LAI.

Fuel Layers correspond to fuel complex where few information is available on the position of the individual fuel type inside of it or when the user wants to summarize them in a unique object. This object is attached to a polygon of the scene, determining the location of the fuel complex. It is generally used to represent understorey, but can be also used to represent canopies. A Fuel LayerSet contains different Fuel Layers, which represent each fuel type included in the Fuel LayerSet. For example, a Fuel LayerSet of garrigue, can contain 3 Fuel Layers: *Quercus coccifera*, *Rosmarinus officinalis* and *Brachypodium retosum*. Each layer is described with its own macroscopic properties, including bulk density, LAI, moisture, cover fraction and characteristic size of clumps in the Fuel LayerSet. In the 3D editor, the individual plants are represented as individual items, with a crown shape, whereas a Fuel LayerSet is represented by a cylinder, which section is the polygon attached to the Fuel LayerSet and the height is the maximum of layer heights contained in the Fuel LayerSet.

Table 1. Attributes of the main vegetation objects included in a vegetation scene

Scene items	Plant attributes	Fuel LayerSet attributes
- Terrain	Identifier, SpeciesName	Identifier
- Grid	Position (x,y,z)	Polygon
- Plant	DBH, TreeHeight, Crown Base Height, Crown	Layers
- Fuel LayerSet	Diameter, MaxDiameterHeight, CrownProfile,	Height, BottomHeight
- Polygon	CrownColor BulkDensity, Leaf Area Idex Live/Dead and Leave/Twig Moistures FireParameters SeverityParameters (Additional attributes for database plant: TeamName, Checked, CloseEnvironment)	Load, CoverFraction

Table 2. Attributes of the Fuel Layers included in the Fuel LayerSets

Fuel Layer attributes
<ul style="list-style-type: none"> • SpeciesName • Height, BottomHeight • Alive/Dead BulkDensity, Leaf Area Index • CoverFraction, PatchSize • Live and Dead Moisture • Additional attributes for database layers: TeamName, Checked, ID, dominance, EdgeBulkDensity, edgeLAI)

4.1 Screen Layouts

4.1.1 CAPSIS Screen Layout

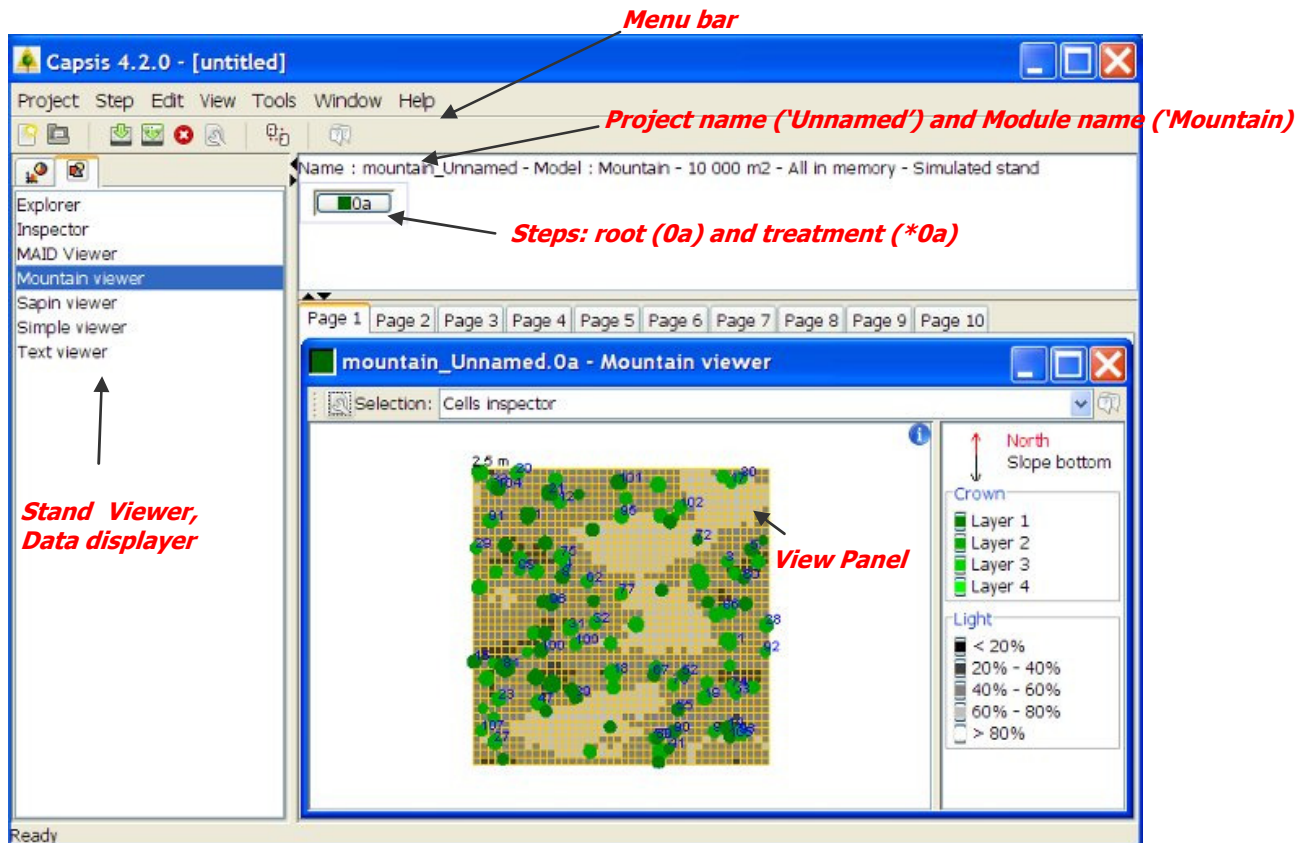

Figure 6: CAPSIS main window

General conventions are used in the *CAPSIS* user windows. The screen layout is composed of several areas:

- The menu bar allows access to the *CAPSIS* functionalities: new project creation, etc.
- An area gives a general overview of the current project: project name and its associated module are indicated. The simulation history memorizes the root step and other steps which result from growth evolutions or silvicultural treatments. Each step has a date and holds a snapshot of the stand at this date, calculated by the red model.
- The left area presents all *extensions* of the platform that are compatible with the module: charts, graphs, maps, etc.
- The bottom-right space displays data according to the selected extension.

4.1.2 Module *Fire Paradox* Screen Layout

The 3D editor is designed to visualize and edit the scene containing the fuel. The main window of the *FIRE PARADOX FUEL MANAGER* is divided into several functionally independent regions: a 3D view panel of the scene (left), a menu bar, a tool bar and a real time control panel (right).

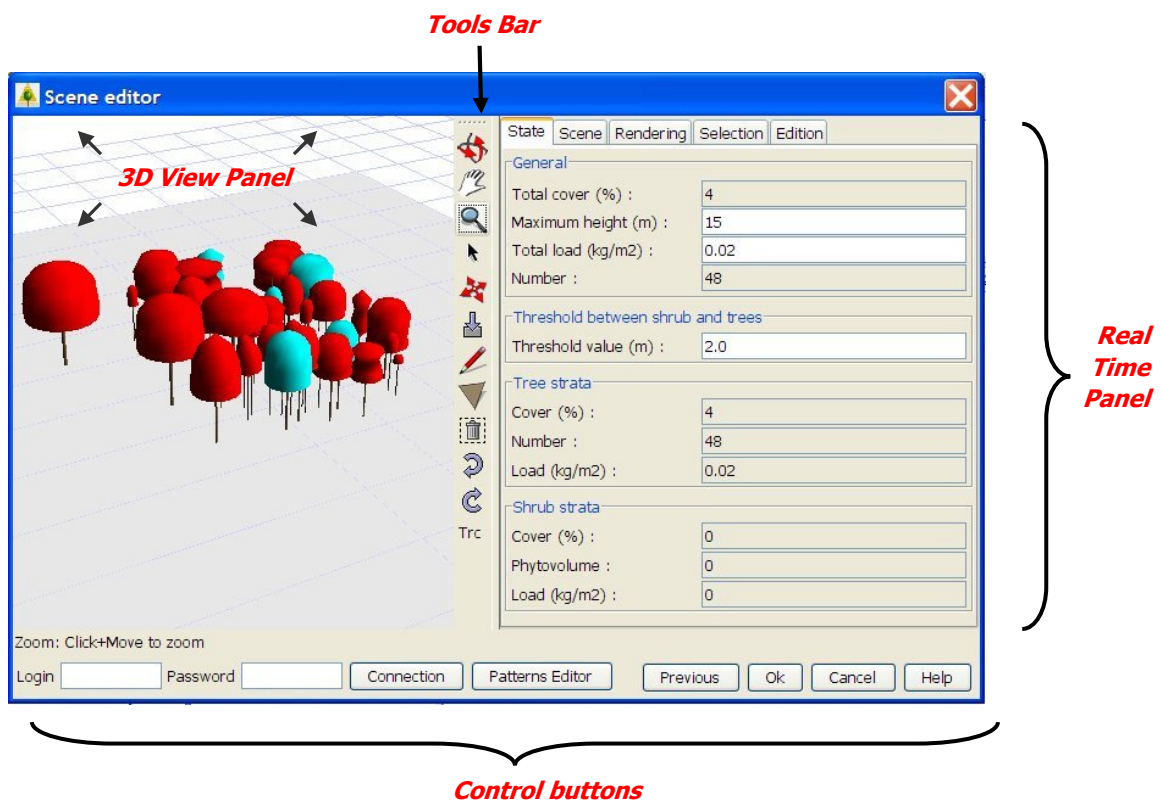

Figure 7: Main window of the FPFM

a) Tools Bar

This area composed of graphical icons, is dedicated to vegetation scene functionalities:

- Camera toolbar buttons perform a number of viewpoint motions interactively



"Orbit" to change the orbit point of view



"Pan" to move the scene vertically and horizontally



"Zoom" to increase or decrease the focus

- Scene modification functionalities:



"Select" to select an object on the scene



"Move" to move an object on the scene



"Add" to add an object on the scene



"Polyline" to draw a polyline



"Polygon" to draw a polygon



"Remove" to remove an object on the scene



"Undo" to cancel the last action



"Redo" to redo the last action

NOTE: All buttons, except "Polyline", "Polygon", "Add" and "Remove" are "sticky" buttons for continuous selecting, panning, zooming, etc. The function of a sticky button you have clicked on is remembered until you select another sticky button. If you select a non sticky button such as the "remove" one after having selected an object; the *FIRE PARADOX FUEL MANAGER* will still remember the previous sticky button function (the selected object is removed and you can select other objects without having to click on "select" again).

b) 3D View Panel

In the middle of the window, the scene in 3D is displayed according to the current visualization parameters.

c) Real Time Panel

The panel on the right is composed of several tabs which interact in real time with the 3D view panel.

- The "State" and "Selection" tabs display in real time information according to the current scene including cover fraction, phytovolume of the understory and fuel load.
- The "Scene" tab permits to list and see all objects displayed on the screen (terrain, grid, polygons, trees).
- The "Edition" tab permits to update precisely displayed objects coordinates.
- The "Rendering" tab permits to modify visualization settings: the scene representation changes automatically.

d) Control buttons

At the bottom, various buttons are available:

- On the bottom left, a user right space and "Connection" button permit to access to some functionalities according to the user profile (*FIRE PARADOX FUEL* database management).
- A "Patterns Editor" allows access to the vegetation pattern designer.
- On the bottom right, a few command buttons are available.
 - "Previous/Next": aims at navigating from generated scene and this main *Fire Paradox* window.
 - "OK": validation of the vegetation scene; the *Fire Paradox* module is initialized.
 - "Cancel": the process is cancelled.
 - "Help": a user guide dedicated to the current window appears.

4.2 Keyboard Shortcuts

Keyboard shortcuts are indicated in square brackets: press simultaneously the combination of keys to perform some tasks. This is a list of the most common keyboard shortcuts in the *FIRE PARADOX FUEL MANAGER*.

Note that the [Escape] key close any *CAPSIS* window quickly; pay attention not to close an important window by accident.

[Ctrl + N]	new <i>CAPSIS</i> project
[Escape]	close the window quickly
[Enter]	validate the window
[Shift + Mouse click]	multi-selection in selection mode
[Shift + Mouse hold down]	pan function in orbit mode
[Ctrl + Z]	cancel last action
[Ctrl + Y]	redo last action
[Alt + R]	orbit

[Alt + T]	pan
[Alt + Z]	zoom
[Alt + S]	selection
[Alt + E]	move
[Alt + A]	add
[Alt + L]	polyline
[Alt + P]	polygon
[Alt + Del]	remove

4.3 Program Help

Help buttons are available in the different dialog boxes in order to assist the user while working.

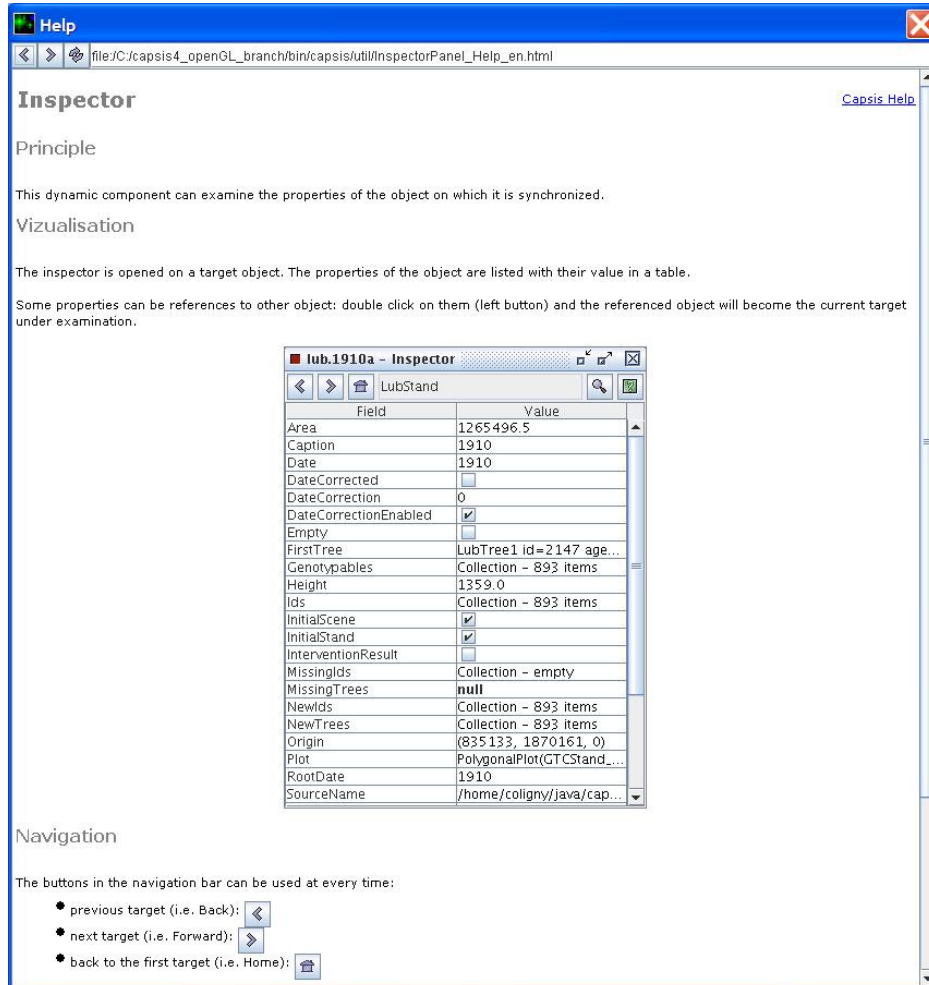

Figure 8: Example of CAPSIS help screen: inspector panel

5 VEGETATION SCENE CREATION

5.1 CAPSIS project creation

A project creation consists in initializing the root step of the *Fire Paradox* module under *CAP SIS* platform; in other words in creating the initial planting set. All manipulative functionalities, which are already available, will be loaded with this stage.

- ➔ Click in the menu bar of the *CAP SIS* interface "Project > New" or [Ctrl + N]. The following dialog window will appear.

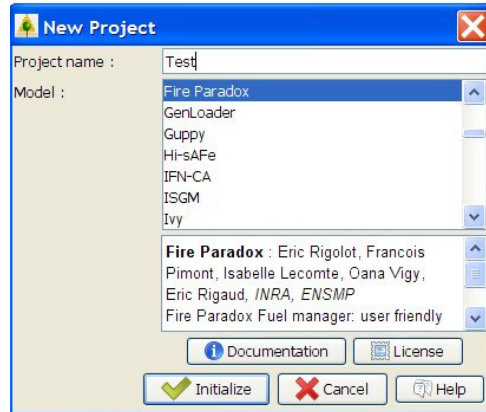

Figure 9: New project window

- ➔ Type a project name.
- ➔ Select the model to be linked: "Fire Paradox"
- ➔ Hit the "Initialize" button. Please refer to the chapter 5.2 for specific instructions.

Note: From this screen, you can also get documentation and information about *FIRE PARADOX* model licence.



Figure 10: Example of Fire Paradox documentation page

5.2 Vegetation scene creation

A scene can be created from text files of various formats containing the description of fuel in terms of layers and can be edited and modified. Polyline and polygon can be added in the scene as well as fuel items (plant, layerSet) with the "add" icon. A scene can be built from scratch, only using "add" icon.

Several creation modes for generating a vegetation scene are currently available throughout the user interface (Figure 11):

- From vegetation inventories: load an input file (database or detailed).
- From field parameters: create a scene based on stand level characteristics.
- From scratch: create an empty scene.
- From a previous scene already saved for reedition

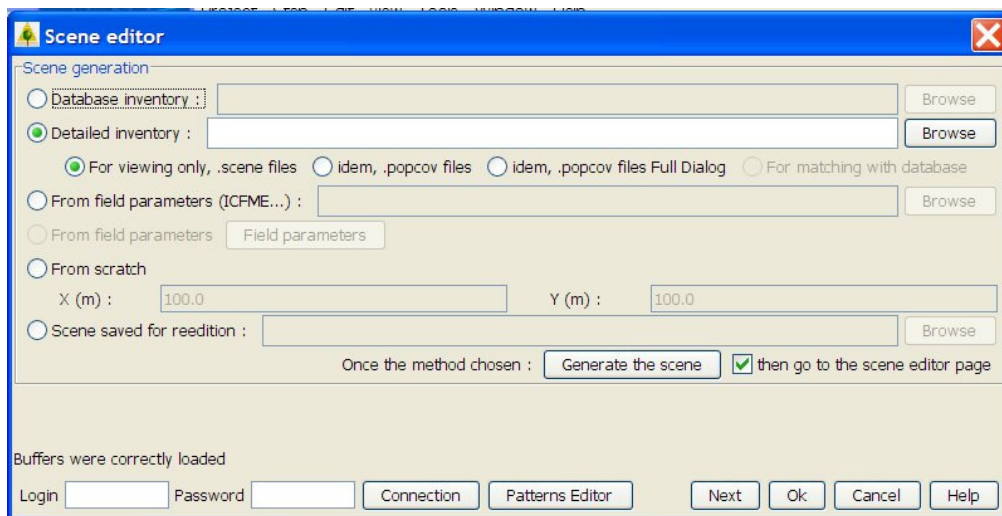

Figure 11: Scene generation window

The scene generation resulting from these different options, are detailed in the next chapters.

5.3 From a database inventory

This option enables to generate a vegetation scene by loading an inventory file which contains only vegetation objects known in the *FIRE PARADOX FUEL* database. The inventory file describes each vegetation object throughout its "ID" in the *FIRE PARADOX FUEL* database, and location. This option requires a connection with the remote database since *species*, *height* and *crown dimensions* are read for each fuel in the database before generating the scene. The inventory file contains also a line describing the dimensions of the terrain. Using this option to generate a vegetation scene will make possible the creation of export files necessary to run the fire propagation model.

5.4 From a detailed Inventory File

A detailed inventory file can be loaded: it describes each vegetation object in details throughout its species, crown dimensions and location. It doesn't require an access to the *FIRE PARADOX FUEL* database because it doesn't contain vegetation object "ID" of the database.

5.4.1 For Viewing Only

This sub option is planned when user doesn't need to run an export of the vegetation scene to be able to run the fire behaviour model. It enables to display on the vegetation scene a wider range of vegetation objects than those stored in the *FIRE PARADOX FUEL* database.

As example, an inventory file "Lamanon_Mixed_WP61_sg.scene" (cf. *Annex 14.1*) is available in the given *CAPSIS* archive and precisely in the "capsis4\data\fireparadox" directory. The file describes 48 trees.

- ➔ Select the "From an Inventory" and "For viewing only" options of the scene generation window.
- ➔ Click on the "Browse" button and select the "Lamanon_Mixed_WP61_sg.scene" file in the "<install_directory>\capsis4\data\fireparadox" directory (e.g. "C:\Program Files\capsis4\data\fireparadox").
- ➔ Click on the "Generate the scene" to display the resulting scene.

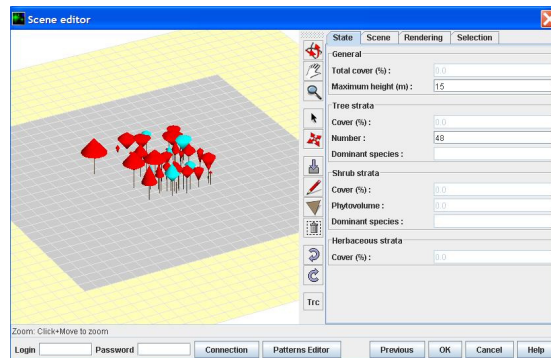

Figure 12: Scene creation from an inventory file

5.4.2 From POP COV files

This sub option enables to generate tree or shrub populations. Several populations can be automatically generated by using some intra and inter populations spatial rules and constraints. Spatial rules use the Gibbs parameter:

Gibbs parameter values: 0 = random distribution; 1000 = regular; <0 = aggregated

The vegetation scene has no link with the *FIRE PARADOX FUEL* database and cannot be exported for running a fire simulation.

As example, an inventory file "_4REC_pop1Pins_bonnes_valeurs.txt" (cf. *Annex 14.1*) is available in the given *CAPSIS* archive and precisely in the "capsis4\data\fireparadox" directory.

- ➔ Select the "From an Inventory" and "idem, .popcov files" options of the scene generation window.
- ➔ Click on the "Browse" button and select the ""_4REC_pop1Pins_bonnes_valeurs.txt" file in the "<install_directory>\capsis4\data\fireparadox" directory (e.g. "C:\Program Files\capsis4\data\fireparadox").
- ➔ Click on the "Generate the scene"
- ➔ You can optionally modify values in the simplified dialog window untitled "Spatial rules and constraints".

5.4.3 From POP COV files Full Dialog

This sub option is similar to the previous one. The only difference is the display of a complete dialog window for defining spatial rules and constraints.

5.4.4 For Matching with Database

This sub option is not available yet. It will be necessary when user will finally need to create an export of the vegetation scene to be able to run the fire behaviour model. As the inventory file doesn't contain vegetation object "ID" of the *FIRE PARADOX FUEL* database, the loading procedure will match each vegetation object with the most similar object present in the database.

5.5 From Field Parameters

This option is useful to generate automatically a vegetation scene, given some indications describing its structure and composition. It may contain a list of dominant tree species (with specific heights and DBH classes) and list of Fuel LayerSets including their respective Fuel Layers for the description of the understorey (height, cover, bulk density, moisture content, ...).

As an example, file "fuelbreak.txt" is available in folder *capsis4/data/fireparadox* (Annex 14.1).

5.6 From Scratch

An empty scene can be generated by giving the dimensions of the terrain.

- ➔ Select the "From scratch" option of the scene generation window.
- ➔ Type the required dimensions (m) of the terrain in the "Length" and "Width" fields.
- ➔ Click on the "Generate the scene" to display the empty scene.

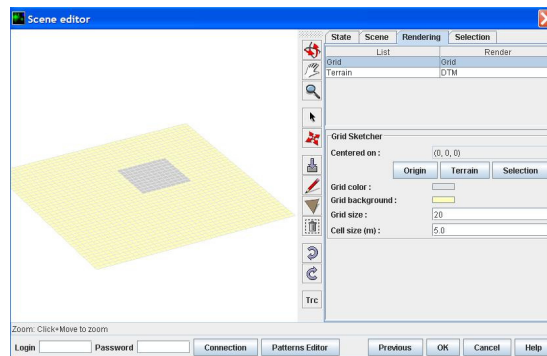

Figure 13: Scene creation from scratch

5.7 From Saved Scene

CAPSIS can save *FIRE PARADOX* scene in a special format that can be re open later for further modifications.

- ➔ Select saved scene on your computer
- ➔ Click on the "Browse" button and select the file in your computer
- ➔ Click on the "Generate the scene" to display the scene.

6 VEGETATION SCENE MODIFICATION

Vegetation scene modification includes the selection, add and remove functionalities.

6.1 Selection

Individual and group selection techniques of vegetation objects are possible throughout the 3D view panel in clicking with the mouse.

Selected vegetation objects appear in the chosen colour for selection (here RED) or in a coloured bounding box.

➔  to select an object on the scene

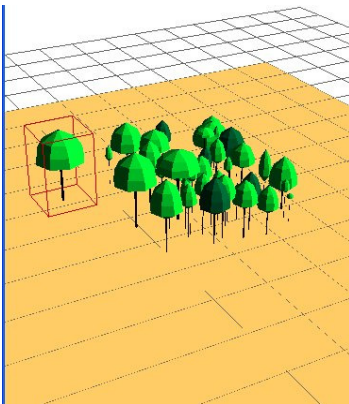

Figure 14: Vegetation objects selection

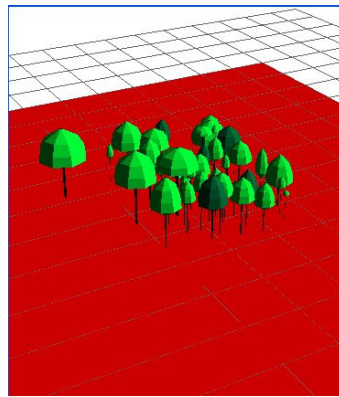

Figure 15: Terrain object selection

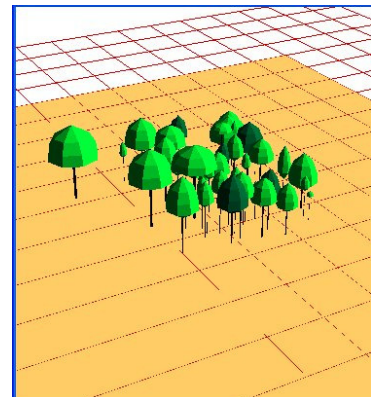

Figure 16: Grid object selection

Note: While a selection is active, functionalities are effective only inside the selection

6.1.1 Individual or Multiple Selection

All type of objects visible on the scene can be selected: vegetation objects (tree, shrub, grass), polygons, polylines, grid and terrain.

- ➔ Click on the "Select" button of the Menu Bar.
- ➔ For simple selection, click with the left-mouse button on desired vegetation objects. This action deselects all previously selected objects.
- ➔ For a multi-selection, hold down the [Ctrl] key while clicking with the left-mouse button on objects.
- ➔ For a selection of objects within a drawn area on the scene: move your mouse while clicking with the left-mouse button and draw a rectangle including the group of objects that you want to select.

6.1.2 Unselection

Hold down the [Ctrl] key while clicking with the left-mouse button on vegetation objects that you want to unselect.



At any time the undo button, permit to cancel last actions, even selections.

6.1.3 Selection with the Scene Inspector

Object selection is also possible with the scene inspector.

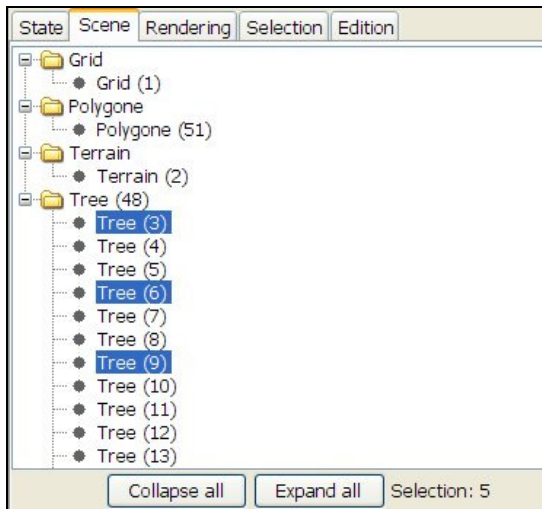

- ➔ Click on the "Scene" tab of the "Real Time Panel". All objects visible on the scene will appear in the inspector.
- ➔ For simple selection, click with the left-mouse button on desired vegetation objects. This action deselects all previously selected objects.
- ➔ For a multi-selection, hold down the [Ctrl] key while clicking with the left-mouse button on objects.

Figure 17: Multi-selection of trees in the scene inspector

6.2 Adding

An interactive mode permits to add objects on the scene. This chapter focuses on the way to display vegetation objects on the vegetation scene, and on the way to add figures as polygons or polylines.

- ➔  to add an object on the scene
- ➔ Choose the vegetation object
- ➔ Choose the planting method process
- ➔ Click on "ADD" to add the object (s)

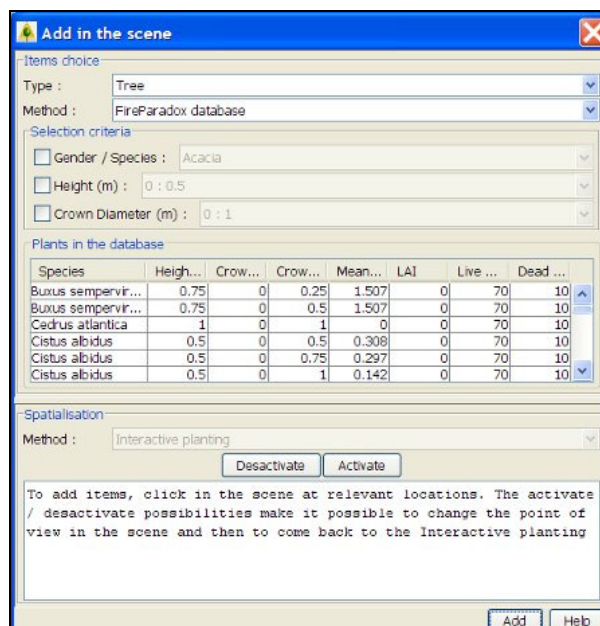

Figure 18: Dialog window for adding a vegetation object in the scene

The interface is divided into two areas dedicated to the selection of "what to add" ("Items choice" frame) and the definition of "how to add" ("Spatialisation" frame).

6.2.1 Item choice: Vegetation Objects Selection

Two drop-down lists permit to indicate the object item to add in the following list:

- FireParadox Database Tree
- Local tree
- FireParadox Database Layer
- Local layer

For each type, selection criteria are displayed to help the user in his research. A table displays available vegetation objects according to the criteria.

a) Adding a FireParadox Database Tree

- ➔ Fill the selection criteria if necessary
- ➔ Select a Tree in the list extracted from the database
- ➔ Add the selected tree on the scene with a planting option

The screenshot shows the 'Items choice' window with the following details:

- Type: Tree
- Method: FireParadox database
- Selection criteria:
 - Gender / Species: Acacia
 - Height (m): 0 : 0.5
 - Crown Diameter (m): 0 : 1
- Plants in the database table:

Species	Height (m)	Crown base H (m)	Crown D (m)	Mean bulk densit...	LAI	Live Moisture (%)	Dead Moisture (%)
Buxus sempervirens	0.75	0	0.25	1.507	0	70	10
Rosmarinus officinalis	0.25	0	0.25	1.377	0	70	10
Rosmarinus officinalis	0.25	0	0.25	2.13	0	70	10
Rosmarinus officinalis	0.25	0	0.3	1.67	0	70	10
Thymus vulgaris	0.25	0	0.39	1.797	0	70	10
Rosmarinus officinalis	0.25	0	0.4	2.335	0	70	10
Rosmarinus officinalis	0.25	0	0.45	2.25	0	70	10
Buxus sempervirens	0.75	0	0.5	1.507	0	70	10
Cistus albidus	0.5	0	0.5	0.308	0	70	10

Figure 19: Adding a Database Tree

b) Adding a Local Tree

- ➔ Select a tree species
- ➔ Fill the tree general information
- ➔ Add the selected tree on the scene with a planting option

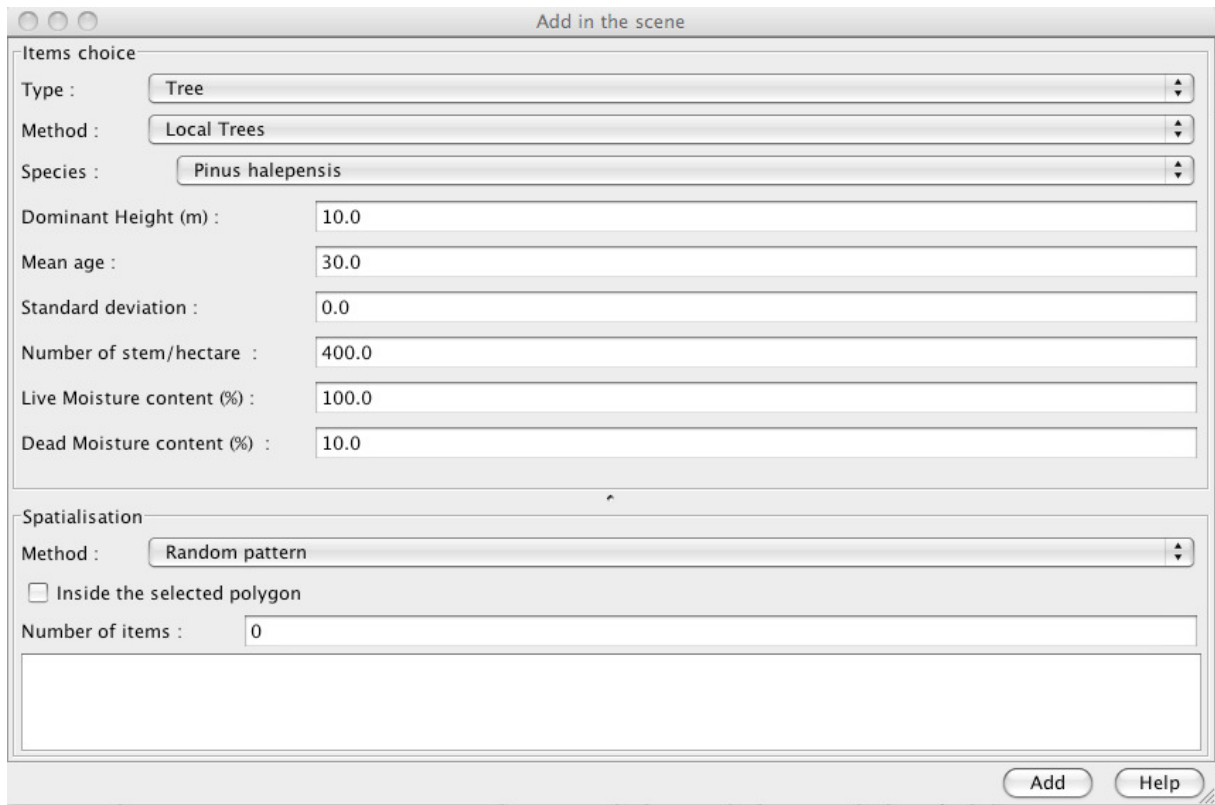

Figure 20: Adding a Local Tree

- c) Adding a FireParadox Layer Sets (a Composite Layer from the *FIRE PARADOX FUEL* database)
- ➔ Select a Layer in the list extracted from the *FUEL* database
 - ➔ Click on "ADD" to add this layer to the composite layer
 - ➔ Update Layer description in the Composite Layer table
 - ➔ Repeat these action as far as the Composite Layer is not complete
 - ➔ Add the Composite Layer on the scene with planting option

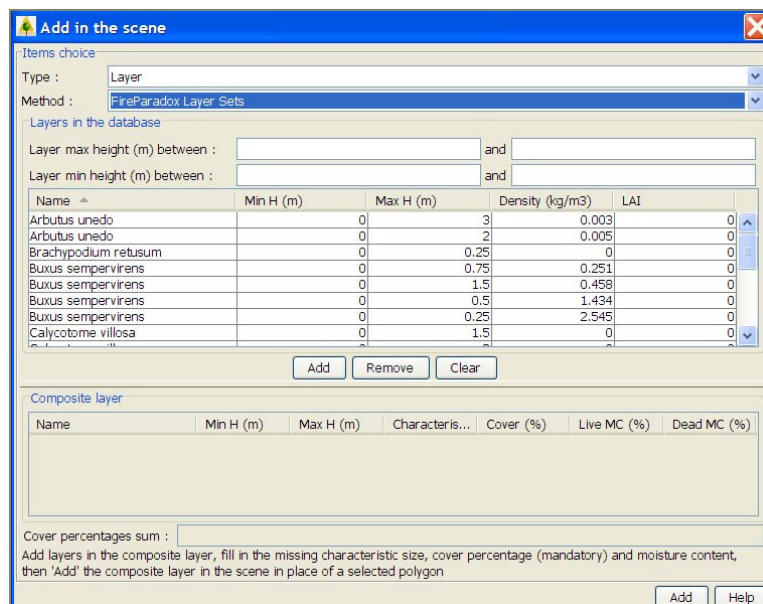

Figure 21: Adding a Layer from the FUEL database

d) Adding a Local Layer

A Local Layer Set is a Composite Layer built with layers that are not extracted from the *FUEL* database. Local Layers may have two origins:

- "Predefined LayerSets": The button "Add layerSet" entails to add the layers of predefined layerSet models. Other default models can be added in a text file if required.
Note: The option for evolution with time is not yet available.
- "Build the LayerSet from individual layers": The button "Add layer" entails to add selected layers one by one.

Note: All the layers included in the "Local Layer Sets" can be edited and modified if the user prefers specific values for a given parameter in the table.

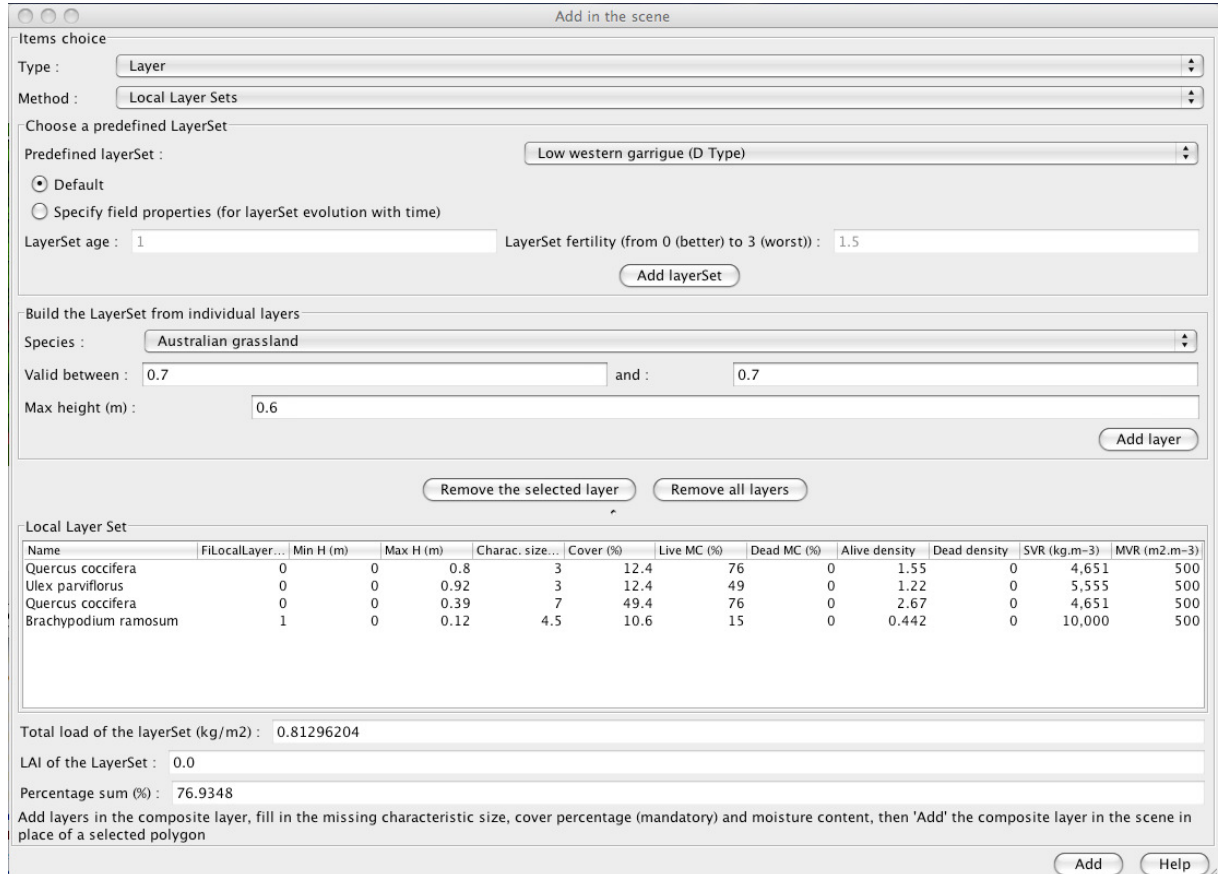

Figure 22: Adding a Local Layer

6.2.2 Spatialisation: Planting Method Process

The planting process is the way to display vegetation objects on the vegetation scene. After having selected a vegetation object, it is necessary to specify its location, its clone number and its planting structure.

Different modes for spatial display of vegetation objects on the scene are currently available:

- ➔ Interactive planting
- ➔ Planting along a line
- ➔ Planting in rows
- ➔ Random patterns

a) Interactive Planting

This option enables to locate trees directly on the scene, with the mouse.

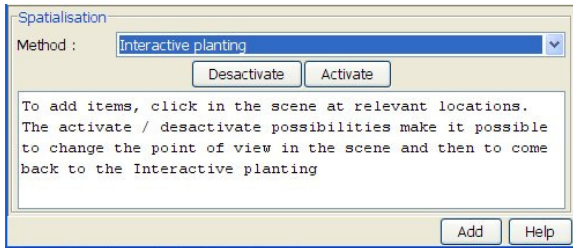

Figure 23: Interactive planting dialog

When this option is activate, one vegetation object will be planted for each click on the scene.

It is possible to deactivate this option, for selecting functionality or any other object on the scene.

b) Along a line

This function permits to plant vegetation objects along a line according to spatial parameters.

- ➔ A line can be a polyline or the contour of a polygon.
- ➔ A "Number of items" or a "Density" per meter can be displayed on the scene.
- ➔ "Absence probability" enables to specify a rate of exceptions in the planting process.
- ➔ "Alea" is the maximum distance that is permitted between the selected line and the effective location of the planted object.

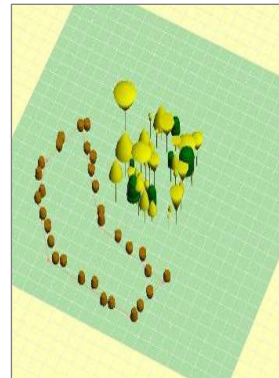
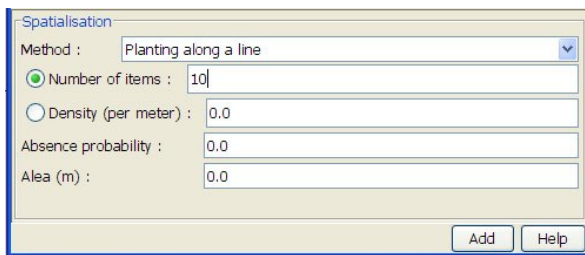

Figure 24: Along line planting process

c) Planting in rows

This function permits to plant vegetation objects in rows according to spatial parameters.

- ➔ Planting can be done on the all scene or only "Inside a selected polygon".
- ➔ "Distance between plants" and "Distance between rows" determine the planting pattern.
- ➔ "Absence probability" and "Random" enables to specify a rate of exceptions in the planting process.

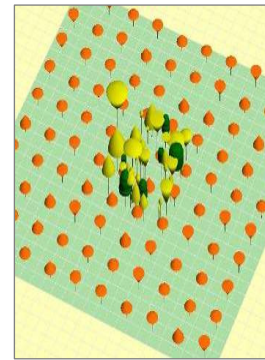
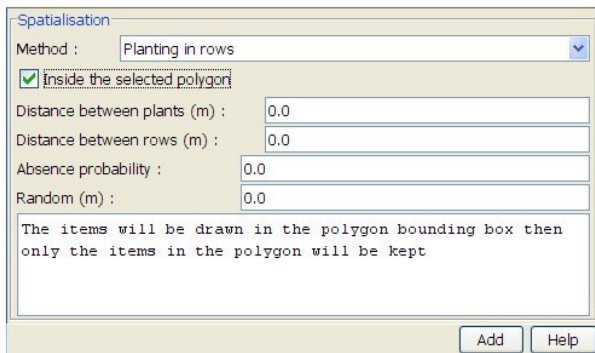

Figure 25: Planting in rows method of planting

d) Random Patterns

This function permits to display a set of vegetation objects following a random pattern.

- ➔ Planting can be done on the all scene or only "Inside a selected polygon".
- ➔ "Number of items" determines the number of trees that will be randomly generated.

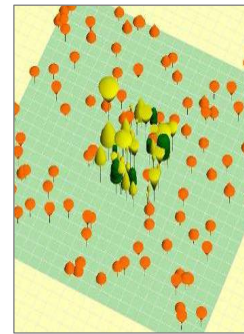
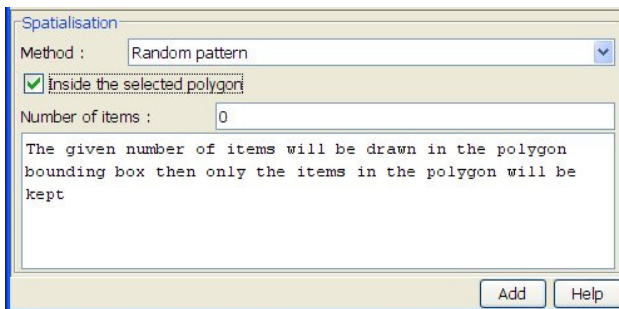



Figure 26: Random pattern method of planting

6.2.3 Adding a Polygon or a Polyline

It is possible to add vegetation objects (individual plants) within or along a polyline or a polygon. The application offers tools to add polylines or polygons on the scene.

- ➔  to draw a polyline
- ➔  to draw a polygon
- ➔ Click on the right icon and draw the figure with you mouse.
- ➔ A double click enables to end the drawing. For a polygon, the figure will be closed automatically.

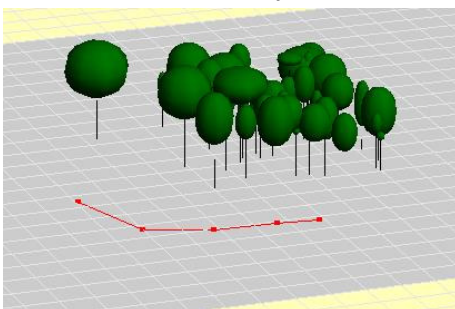

Figure 27: Drawing a polyline

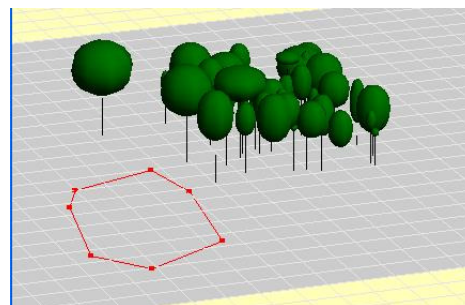



Figure 28: Drawing a polygon

6.3 Updating

The scene structure can be modified by moving vegetation objects on the scene. Several vegetation objects can be moved simultaneously thanks to a multi-selection process.

Silvicultural treatments, in other word the modification of the vegetation structure on a predefined scheme (tree thinning, brush clearing, etc.), are available as an "Intervention" once the scene has been validated (see Chapter 10).

6.3.1 Moving Functionality

- ➔ Select vegetation object(s) to be moved.
- ➔  to move an object on the scene.
- ➔ Hold down the left-mouse button while moving the cursor to the target location.

The "Edition" tab also permit to update precisely selected objects coordinates.

- ➔ Select vegetation object(s) to be moved.
- ➔ Select on "Edition" tab of the "Real Time Panel".
- ➔ Change the object coordinates

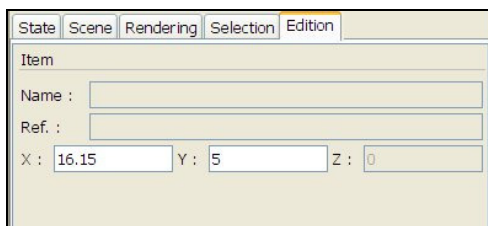

Figure 29: Tree coordinates edition

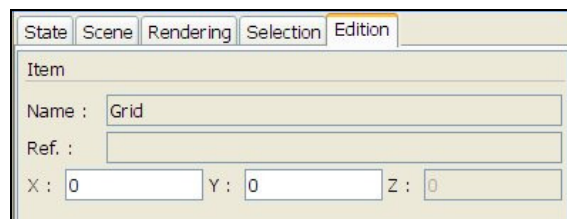



Figure 30: Grid coordinates edition

6.3.2 Deleting Functionality

The suppression is available on pre-selected vegetation objects.

- ➔ Select vegetation object(s) you want to delete.
- ➔  to remove the object on the scene.

7 VEGETATION SCENE VISUALISATION

7.1 Viewpoint Motions

View motion functions allow the user to interactively rotate, zoom and pan the vegetation scene.

Note: x-axis (horizontal) as direction of fire propagation, z-axis as vertical direction and y-axis as the depth of the scene.

7.1.1 Orbit Functionality

3D orbit motion permits to change the user viewpoint while keeping the target scene fixed.

- ➔ Click on  "Orbit" button of the Menu Bar.
- ➔ Hold down the left-mouse button and drag in the 3D view panel:
 - ⇒ Drag up/down to rotate the scene around the x-axis,
 - ⇒ Drag left/right to rotate the scene around the z-axis.

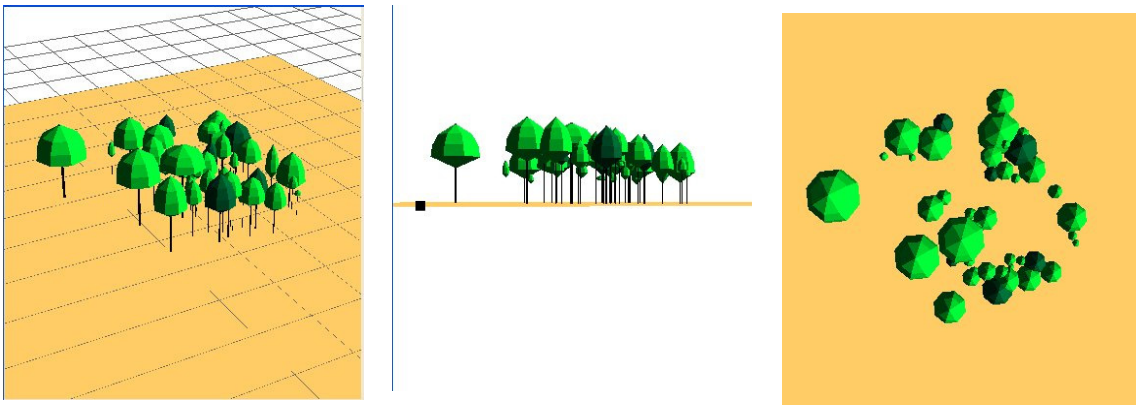



Figure 31: Angular, side and bird's eye views obtained by orbit view motion

7.1.2 Zoom Functionality

The zoom function moves the viewpoint either further from (zoom out) or closer to (zoom in) the vegetation scene. Two ways are available:

- ➔ Click on  "Zoom" button of the Menu Bar.
- ➔ Hold down the left-mouse button and drag in the 3D view panel:
 - ⇒ Drag up to zoom out,
 - ⇒ Drag down to zoom in.

7.1.3 Pan Functionality

The pan functionality is useful to crop the view as it moves the scene while keeping the viewpoint fixed. Two ways are available:

- ➔ Click on  "Pan" button of the Menu Bar.
- ➔ Hold down the left-mouse button and drag the cursor in the desired direction.

7.2 Object Renderers

Objects (terrain, grid and vegetation objects) of the vegetation scene can be visualized in different ways thanks to several renderers.

As any renderers are in fact *CAPSIS* extensions, the *Fire Paradox* module needs only to match an extension to be able to use it. So, "Bounding Boxes", "Lollypops" and "Grid" renderers are used as they were released in *CAPSIS*; it implies to adapt some functionalities to the *FIRE PARADOX FUEL MANAGER* requirements. On the contrary, the "Pattern Sketcher" renderer was especially developed for the *FIRE PARADOX FUEL MANAGER* purposes.

7.2.1 Renderers Dialog Windows

Renderers can be user-configured in the "Rendering" tab of the "Real Time Panel". The tab is composed of two frames:

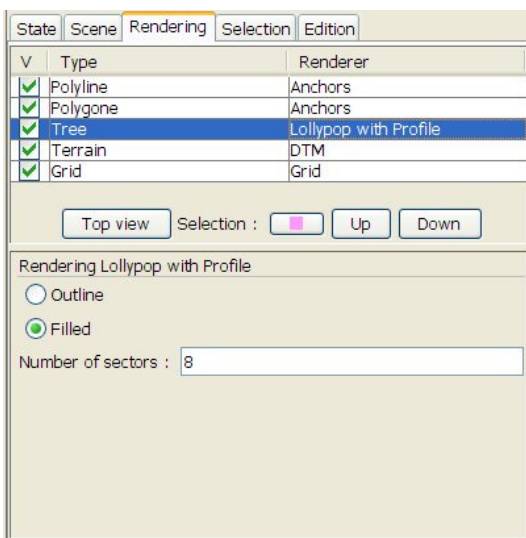

- The "Renderers list" at the top displays all objects (terrain, grid and vegetation objects) which are contained in the scene with an associated render.
- The "Settings pane" permits to edit settings which are specific to each kind of render. For instance, if vegetation objects are displayed with the lollypop render, the user can change the settings for the crown representation.

Figure 32: Object renders panel

- ➔ Right-click on an object item of the "Renderers' list" to change its current render with one of the available ones.
- ➔ In the corresponding "Settings pane", you can modify its parameters.

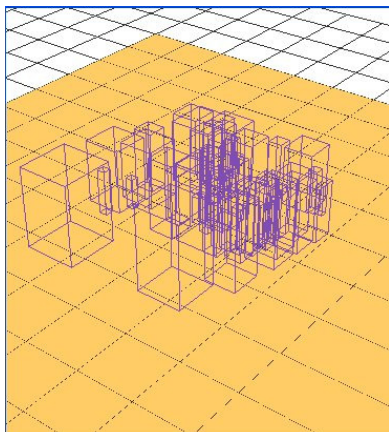

Figure 33: Tree bounding boxes render

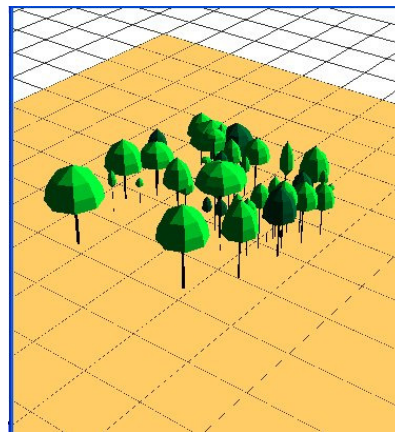

Figure 34: Tree lollypop with profile render

7.2.2 Pattern Sketcher Render

A "Pattern Sketcher" render has been created especially for the *FIRE PARADOX FUEL MANAGER*. Dedicated to vegetation objects, this render permits to visually differentiate categories of vegetation objects using geometric forms and colours. Please refer to the specific "Patterns' Editor" (chapter 9) to know more about editable functions.

Various geometric shapes of the tree crowns may be used to display various tree species or different height classes of the same species. A colour setting enables further details in vegetation classification display.

The "Settings pane" dedicated to the "Pattern Sketcher" render is divided into two main panels.

a) "Colors" frame

This frame contains four options and a table. According to each option, the table content differs and the user can set colors to different targets. Setting colors in function of criteria permits to visually analyse the scene (chapter 8).

- "One color" option: set a unique color to all vegetation objects of the scene
- "By taxon" option: set different colors for each taxon of the scene.
- "By height threshold (m)" option: set a color to shape patterns according to a height threshold. Fill in a value in the corresponding field and validate by pressing the [Enter] key.

b) "Rendering" frame

This frame reused similar functionalities – visible/invisible and filled/outline options – as for the lollipop render. Two additional options are proposed:

- ➔ Untick the "Flat" option to display shading effects.
- ➔ The "Light" option permits to switch on/off the light which illuminates the scene. The use of this parameter is dedicated to the fire damage visualisation; please refer to chapter 10 for further details.

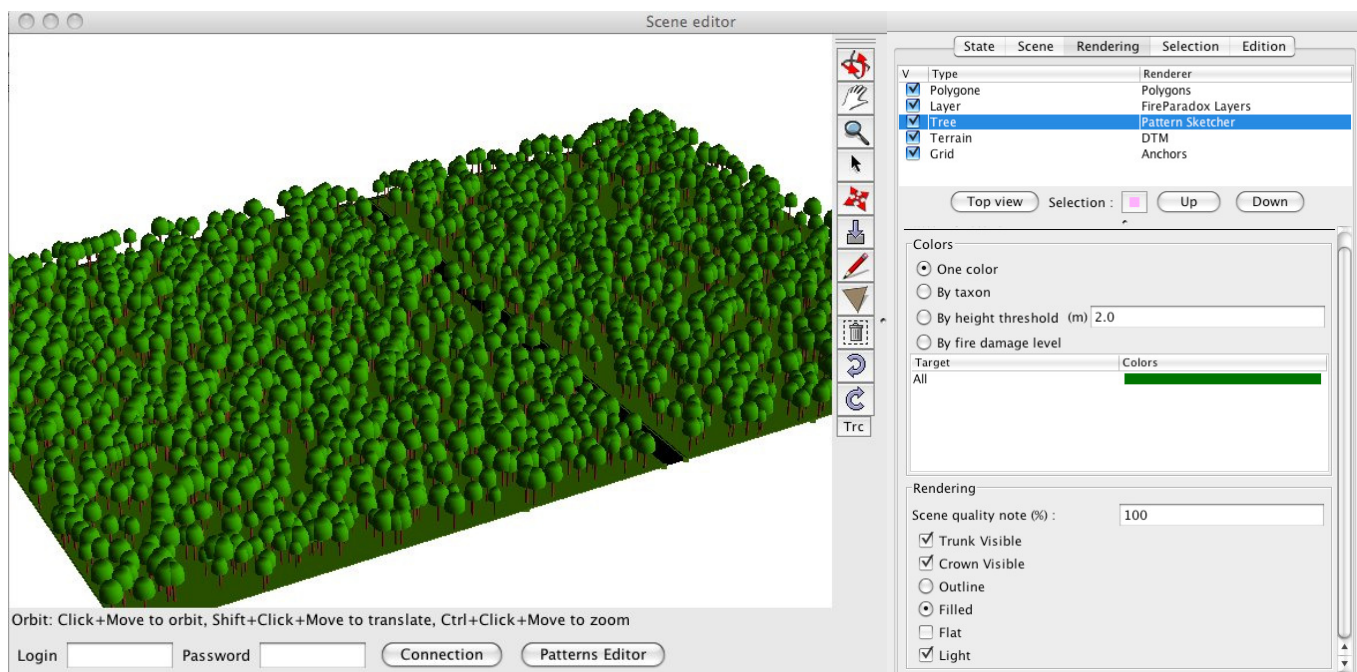

Figure 35: Pattern Sketcher Render options

7.2.3 Degraded modes for heavy scene manipulation

Special attention has been paid to the robustness and efficiency of scene manipulation, because 3D visualization is a costly technology and items displayed on the vegetation scene can be very numerous.

First, a degraded mode based on skeleton of tree crown is used by default during view manipulation (fast mode).

Second, the rendering of trees is degraded when tree number is high (Table 3), so that scene manipulation is maintained. The quality of this representation can be temporary increased for more accurate visualization.

Table 3. Rendering mode by default depending of the number of trees

Tree number	Rendering	Quality note
<=20,000	Crown and trunk plotted, hyperbolic decrease of the number of sectors use for crown representation from 16 to 4	Between 50 and 100 %
<=150,000	Crown plotted only, 4 segments only for crown representation, for the highest trees; anchorage only for the smallest; the proportion of trees represented by their anchorage increase linearly with the tree number	Between 1 and 50 %
>150,000	All trees represented by default by their anchorage (number of pixel depending on tree size)	1 %

To increase rendering level of the "Pattern sketcher" of trees can be improved or degraded manually through the parameter "Scene quality note", with can vary from 0 (worse resolution) to 100 % (best representation).

8 VEGETATION SCENE ANALYSIS

Descriptive analysis is available in the "Real Time Panel" on the right side of the *FIRE PARADOX FUEL MANAGER* main window (Figure 7). Analysis can be made on the whole set of vegetation objects or limited to a subset. In addition, visual analysis refers to different displays of the vegetation objects in the 3D panel.

In addition to relevant statistics, vegetation scene screenshots will give a visual overview of the vegetation scene.

8.1 Descriptive Analysis on the whole set of Vegetation Objects

The "State" tab of the "Real Time Panel" is dedicated to the analysis of the whole set of vegetation objects. The aim is to display in real time indicators relative to the vegetation scene composition and structure. It aims at helping user to follow-up the construction of the scene and to compare its current state to initial objectives: cover, presence of dominant species, etc.

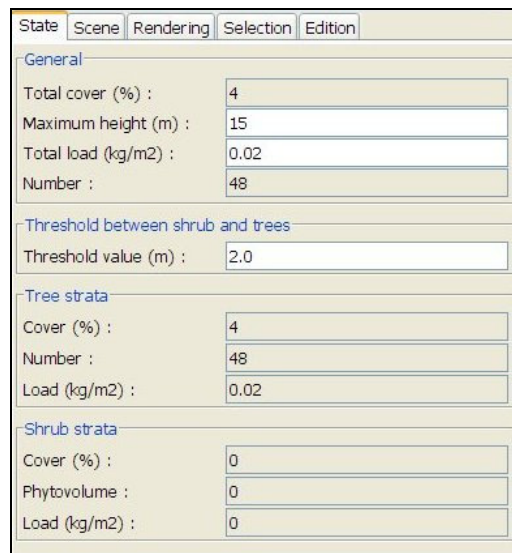

The screenshot shows a software interface with a tabbed menu at the top: State, Scene, Rendering, Selection, Edition. The 'State' tab is active. Below the menu, there are four sections of data, each with a title and several input fields:

- General**: Total cover (%) : 4; Maximum height (m) : 15; Total load (kg/m2) : 0.02; Number : 48.
- Threshold between shrub and trees**: Threshold value (m) : 2.0.
- Tree strata**: Cover (%) : 4; Number : 48; Load (kg/m2) : 0.02.
- Shrub strata**: Cover (%) : 0; Phytovolume : 0; Load (kg/m2) : 0.

Figure 36: Descriptive analysis, State panel

The indicators available are:

a) General

- "Total cover (%)": total cover fraction of the vegetation displayed on the scene
- "Maximum height (m)": height reached by the highest vegetation object.
- "Total Load (kg/m2)": total fuel load (only fine fuel)
- "Number": the number of vegetation objects present on the scene.

b) Threshold between trees and shrub

- "Threshold value (m)": vegetation objects lower than the threshold value belong to the shrub strata, whereas others belong to the tree strata.

c) Tree strata

- "Cover %": cover fraction of the tree strata
- "Load (kg/m²)": fuel load of the tree strata (only fine fuel is considered).
- "Number" of vegetation objects in the tree strata.

d) Shrub strata

- "Cover %": cover fraction of the shrub strata
- "Phytovolume": bulk volume of shrub strata (m³/ha)
- "Load (kg/m²)": fuel load of the shrub strata (only fine fuel is considered).

8.2 Descriptive Analysis on Selected Vegetation Objects

The "Selection" tab in the "Real Time Panel" permits to display information on selected vegetation objects. The tool called "Inspector" displays detailed data on the selected object.

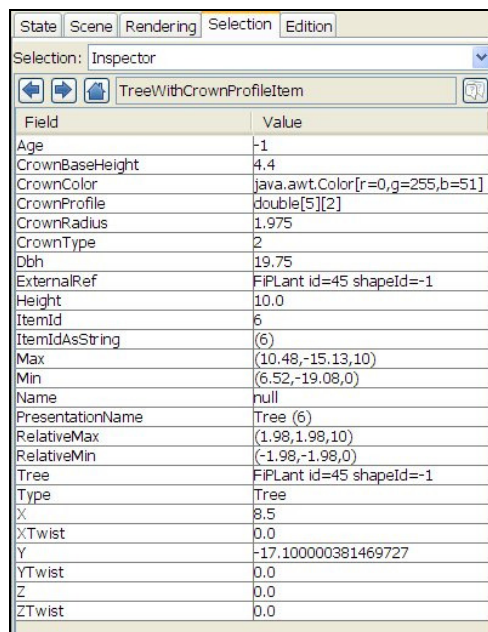

Field	Value
Age	-1
CrownBaseHeight	4.4
CrownColor	java.awt.Color[r=0,g=255,b=51]
CrownProfile	double[5][2]
CrownRadius	1.975
CrownType	2
Dbh	19.75
ExternalRef	FiPlant id=45 shapeId=-1
Height	10.0
ItemId	6
ItemIdAsString	(6)
Max	(10.48,-15.13,10)
Min	(6.52,-19.08,0)
Name	null
PresentationName	Tree (6)
RelativeMax	(1.98,1.98,10)
RelativeMin	(-1.98,-1.98,0)
Tree	FiPlant id=45 shapeId=-1
Type	Tree
X	8.5
XTwist	0.0
Y	-17.100000381469727
YTwist	0.0
Z	0.0
ZTwist	0.0

Figure 37: Tree Inspector Panel

8.3 Visual Analysis

During the Pattern render development, some options were developed in addition such as setting colours to shape patterns according to criteria species or height threshold.

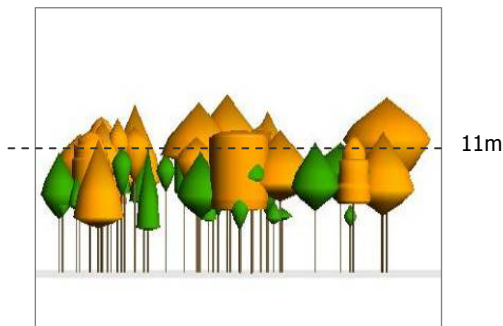

Figure 38: By height threshold

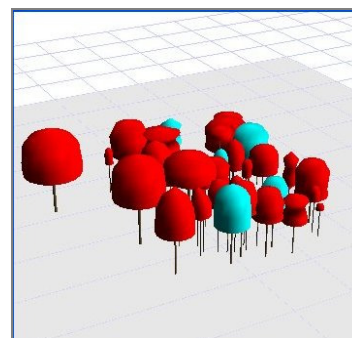

Figure 39: By species

Figures 38 and 39 show perspective and side views to display the vegetation scene in using:

- two different colours for vegetation objects over and underneath 11 m.
- two different colours according to the species criterion, *Pinus halepensis* and *Quercus ilex*.

8.4 Effects of Fire Visualisation

Fire damage on vegetation objects has been mainly focused on fire-induced tree mortality. Several fire impacts on trees crown and trunk have been defined and can be visualized at the scene scale.

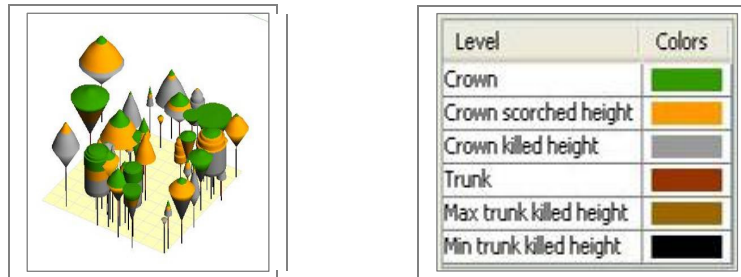

Figure 40: Visualisation of fire impacts on trees

8.4.1 Crown Damages visualisation

Three levels of crown damages are classified:

- "Crown": green per default.
- "Crown scorched height": yellow per default.
- "Crown killed height": grey per default. The best display of this impact would be transparent in order to represent the dead fuel but it is too much resource consuming.

8.4.2 Bole Damages visualisation

Bark charring is shown on tree trunk with min. and max. heights.

- "Trunk": brown per default.
- "Max trunk charred height": dark per default.
- "Min trunk charred height": dark per default.

8.5 Visualisation Options

For Pattern sketcher render, several visualisation options are available:

- Trunk visible (Yes/No)
- Crown visible (Yes/No)
- Crown filled or outlined
- Crown flat (Yes/No)
- Light (Yes/No)

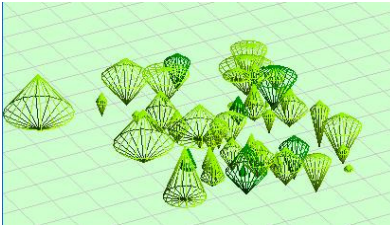
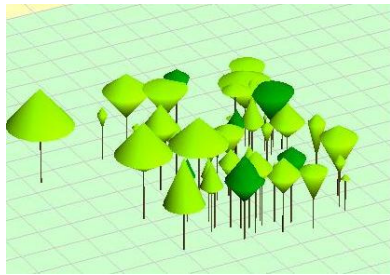

Figure 41: Various visualisations options of pattern sketcher render

9 PATTERNS' EDITOR

The crown Patterns' Editor enables to create shape patterns and to assign those typical crown profiles to groups of vegetation objects. Three criteria are taken into account – *taxon*, *height* and *environment* (openness: open/closed environment) – to constitute groups of vegetation objects. Crown overall structure depends strongly on these three criteria.

- ➔ Click on the "Patterns' Editor" button in the "bottom toolbar" to access the Patterns' Editor and its functionalities (please note that it takes a few seconds to open the Patterns' Editor for the first time).

9.1 Screen Layout

The Patterns' Editor main interface gives an overview of available associations between criteria and shape patterns. Advanced functionalities can be accessed throughout the different areas of this dialog window.

Note: Several interfaces deals with shape patterns; an overview of links is displayed in *Annex 14.2*.

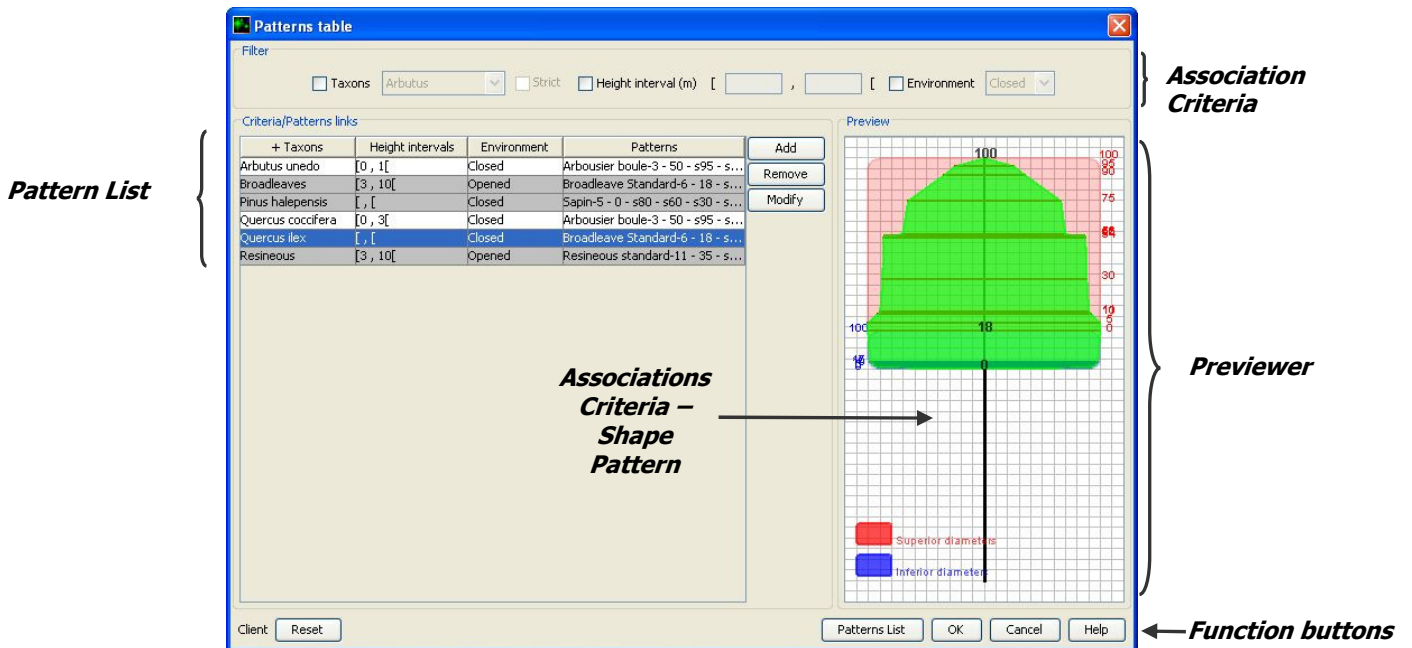

Figure 42: Main window of the Patterns' Editor

a) Frame "Filter"

The frame "Filter" permits to sort all available associations using the three criteria: *taxon*, *height* interval and *environment*. Check a box in front of a criterion to filter the associations.

- The "Taxa" drop down list contains all taxa stored in the *FIRE PARADOX FUEL* database.
 - Select a genus or species to sort associations mentioning it.
 - Check the "Strict" box to make a search on association with the right taxon.
 - Unchecking it lets the search performed on the right taxon and less taxonomic level (e.g. criteria = *Quercus*; associations with *Quercus* and related species are searched – *Quercus ilex*, etc.).
- The "Height interval (m)" contains two fields dedicated to the lower and upper limits of an interval, respectively inclusive and rejected values.

- Fill in a value as lower limit to search all associations which is higher.
- Fill in a value as upper limit to search all associations which is lower.
- Fill in values as lower and upper limits to search all associations which height is included in the specified interval.

Note that associations with no specified height interval display all the possible results.

- The "Environment" drop down list contains two values: open and closed.

b) Frame "Criteria/Pattern links"

- Table

This frame displays available associations between criteria and shape patterns. Each line of the table is an association: the first three columns correspond to the criteria and the last one indicates the associated shape pattern name.

Associations of the table can be sorted by column entitled by clicking on.

- Buttons

Manipulative functionalities are available throughout the "Add", "Remove" and "Modify" buttons.

- Create an association: refer to chapter 9.2.1.
- Update an association: refer to chapter 9.2.2.
- Delete an association: refer to chapter 9.2.3.

c) Frame "Preview"

A preview of the selected shape pattern is displayed at the right side of the interface. Inferior and superior areas are displayed as well as the dimensions of each crown diameter.

A problem subsists in the shape pattern proportions: as the crown is expressed in percentage; it should be a cube and remain a cube when the window is re-size computer.

d) Patterns' List

At the bottom right of the window, a "Patterns' List" button permits to have access to a dialog window dedicated to available shape patterns; refer to chapter 9.3.1.

9.2 Association: Shape Pattern linked to a Group of Vegetation Objects

A shape pattern is supposed to be created in the purpose of being used by a group of vegetation objects. That's why criteria are specified in a first time to identify a collection of vegetation objects for which a shape pattern is then assigned.

According to the *taxon*, *height* and *environment* criteria, each vegetation object should have a reference shape pattern.

The dialog window designed to associate criteria to a shape pattern is composed of three areas:

- The "Criteria" area displays the three criteria which can be filled in.
- The "Patterns" area offers three options to choose a shape pattern.
- The "Preview" area is the same as described in the previous dialog box.

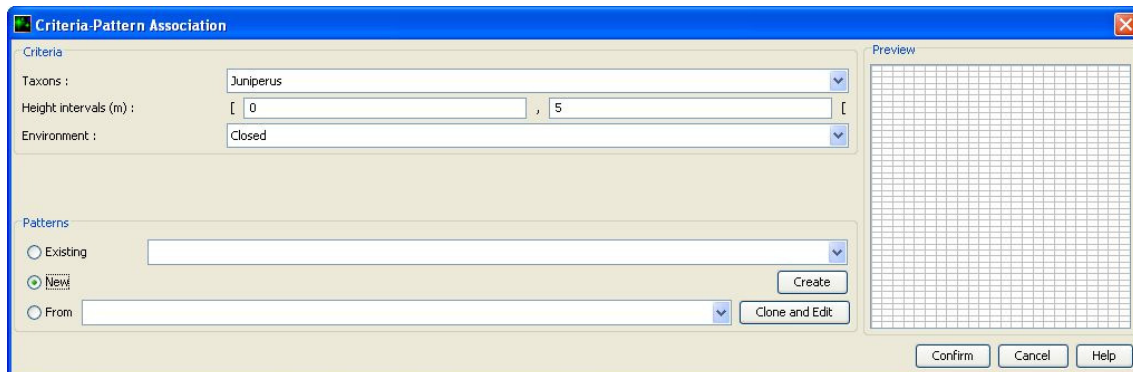

Figure 43: Add and update association window

9.2.1 Create an Association

It is forbidden to create similar associations using the same taxon, height intervals and openness.

- ➔ Click on the "Add" button of the Patterns' Editor main window.
- ➔ Fill in the right criteria. The "Taxon" one is mandatory.
- ➔ Associate a shape pattern to the criteria:
 - ⇒ An existing one: select an available shape pattern in the drop down list.
 - ⇒ A new one: click on the "Create" button to create a new shape pattern;
 - ⇒ A clone one: select an available shape pattern in the drop down list and click the "Clone and edit" button. This option is useful to create a new shape pattern based on an existing one.
- ➔ Validate by clicking "Confirm"; the new association is added to the table.

9.2.2 Update an Association

Updating an association consists in updating the criteria and/or updating the associated shape pattern. Those modifications imply to take into account the same coherence rules as for a new association.

- ➔ Select an association in the table.
- ➔ Click on the "Modify" button of the Patterns' Editor main interface to open the same window as for adding an association. The parameters of the selected association are already filled in and can be modified.
- ➔ Validate your changes by clicking the "Confirm" button.

9.2.3 Remove an Association

Associations can be removed by two ways:

a) "Remove" button

- ➔ Select an association in the table.
- ➔ Click on the "Remove" button of the Patterns' Editor main interface to delete the current association. The user must confirm before really removing the association.

b) “Reset” button

At the bottom left of the interface, the “Reset” button permits to delete all “client” associations.

9.3 Shape Patterns

9.3.1 Shape Patterns Dialog Windows

Two dialog windows enable to manage shape patterns. The first one permits to describe a shape pattern and the second one is listing all available shape patterns.

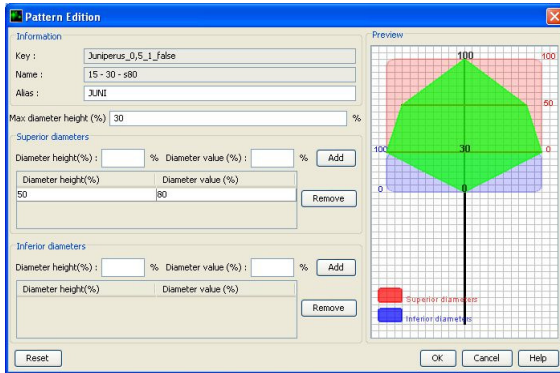

Figure 44: Shape patterns edition window

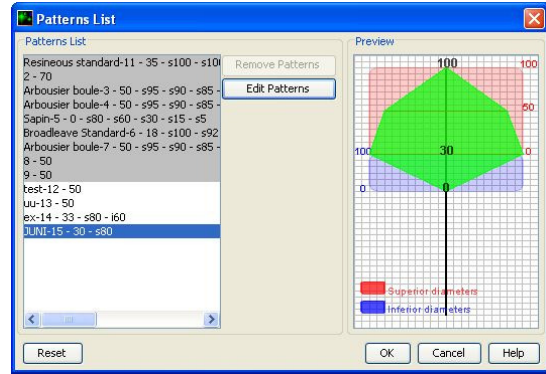

Figure 45: List of available shape patterns

a) Shape Patterns’ List Window:

- “Patterns’ List” frame
 - A list of available shape patterns is displayed.
 - The “Remove patterns” button permits to delete a pre-selected shape pattern.
 - The “Edit patterns” button permits to modify the shape pattern description.
- The “Preview” frame, displayed on the right side of the window, gives an overview of the selected shape pattern.
- The “Reset” button permits to delete all associations.

b) Shape Pattern Edition Window:

- The “Information” frame contains several data to identify clearly each shape pattern:
 - A “Key” as a single identifying.
 - A “Name” composed of an alias – if any, a shape pattern number and some information on crown diameters (e.g. “JUNI-15-30-s80” means that the alias is JUNI; the pattern number is 15; the max diameter height is at 30% of the crown height and an intermediate diameter is set at 80% of the superior area).
 - An optional “Alias” can be given to each shape pattern for a better readability.
- The “Max diameter height” field contains the max diameter height. Per default, it is set at 50% of the crown height.
- “Superior diameters” and “Inferior diameters” frames are structured in the same way:
 - Two fields are dedicated to set the intermediate diameter parameters: the diameter height position in the crown (%) and its length proportionately to the max diameter.

- The "Add" button permits to create the new diameter according to its parameters.
- A table summarizes all intermediate diameters.
- The "Remove" button permits to delete a pre-selected intermediate diameter.
- A "Preview" frame is displayed on the right side of the window to give an overview of the shape pattern during its construction.
- The "Reset" button permits to reset the parameters as it was at the beginning (without warning).

9.3.2 Create a Shape Pattern

A shape pattern can only be created during the creation process of an association.

- ➔ Click on the "Create" button.
- ➔ Give an alias (optional) to the shape pattern. The key and name data are automatically generated.
- ➔ Modify the max diameter height and press the [Enter] key to validate.
- ➔ Add intermediate diameter in the superior and/or inferior areas of the crown by filling in the corresponding parameters. Click on the "Add" button or press the [Enter] key to validate. The table is automatically refreshed. Columns of the table are editable in double-clicking values; press the [Enter] key to validate.
- ➔ Press the "Ok" button to validate the shape pattern description.

9.3.3 Update a Shape Pattern

Knowing first the shape pattern to update, go to the right interface throughout the one displaying all shape patterns.

- ➔ Click on the "Edit patterns" button to open the same interface as for a shape pattern creation.
- ➔ Modify all the necessary parameters (alias, intermediate diameter dimensions, etc.) and validate by clicking the "Ok" button.

9.3.4 Delete a Shape Pattern

A pattern shape can't be suppressed if it is used in an association.

From the "Patterns' list" window, shape patterns can be removed by two ways:

a) "Remove Pattern" button

- ➔ Select a shape pattern in the list.
- ➔ Click on the "Remove Patterns" button to delete the selected shape pattern. Validate the confirmation dialog box.

b) "Reset" button

At the bottom left of the interface, the "Reset" button permits to delete all shape patterns.

10 STAND EVOLUTION AND INTERVENTIONS

When a vegetation scene is ready (Figure 47), it can be validated with the "OK" button of the scene editor panel and it becomes an initial step (0a) (root step). From this initial step, an various evolution scenarios can be run.

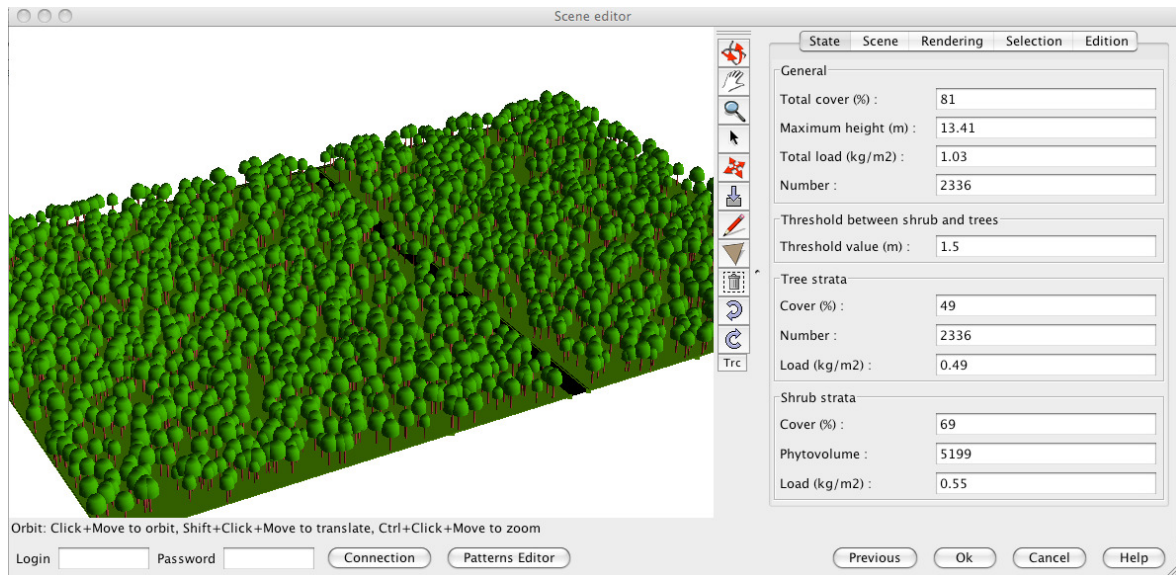

Figure 47: An example of ready to validate vegetation scene

CAPSIS hosts models for forests / plantations growth and dynamics modeling. All modules, including the *FIRE PARADOX MODULE* can be run under the same framework. Under a given project, different simulations can be run to investigate several scenarios of the life of a stand. Each simulation history contains different steps to describe stand evolution, human interventions and ecological perturbations. Projects memorize the different steps of the simulation history. Each step has a date and holds a snapshot of the stand at this date, calculated by the linked model. A simulation always contains a root step, supporting the initial stand, either loaded from file or virtually generated. When the project is initialized (i.e. model parameters are set and initial stand is loaded), it appears in the Project Manager interface (Figure 48). A header shows its main properties (name, model name, surface...) and the initial stand (0a) is linked to the root Step with a date. The Project Manager provides a Step contextual menu (the Step Menu) which contains Step management options.

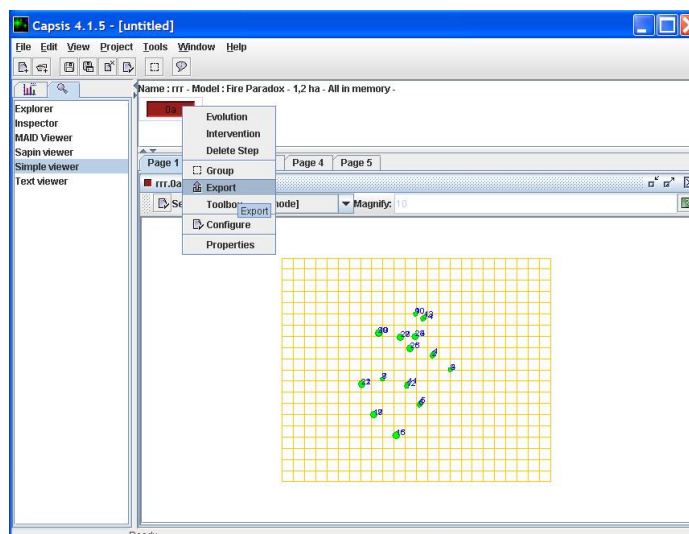

Figure 48: CAPSIS project manager interface, with the step contextual menu displayed

When you click on a step (left button), it becomes the Current Step (with a pressed look) and the project becomes the Current Project (with a project selection color). Actions in the Project menu occur on the current project.

10.1 Project configuration, saving and opening

- ➔ Open the Project Configuration dialog
- ➔ Select the project by left-clicking one of its steps
- ➔ Project > Configure
 - Change the project name
 - See more or less steps in the Project Manager
 - Watch the settings of the *CAPSIS* model linked to the project

Projects can be saved on disk and reloaded later on in the same exact state. The linked model is also saved with its current settings in order to be reusable after re-opening.

- ➔ To save a project on disk:
 - Select the project by clicking on one of its steps
 - Project > Save As
 - Choose a location and file name (free file extension)
 - Validate
- ➔ To open a project from disk:
 - Project > Open
 - Select the file containing the project in the file system
 - An overview shows information of the selected project / file
 - Validate

10.2 Groups

Some models manage individual trees or plot cells in their data structure. For these models, it is possible to create groups of trees or plot cells. These groups can be named and then used in the Viewers (ex: restrict to trees higher than 10m) or in graphical outputs.

- ➔ To open the "GROUP" catalog
 - StepMenu > Group
- ➔ Create a new "GROUP"
 - Group catalog > New
 - Choose a name for the group
 - Choose group type (ex: Trees / Dynamic)
 - Select a filter
 - Parameterize it
 - Inspect the result in the display
 - Optionally refine selection with other filters
 - When everything is ok, Validate

The group is saved to disk, it is now known by *CAPSIS* until it is removed from the catalog.

- ➔ Customize a "GROUP"
 - Group catalog
 - Select a Group to be customized in the list
 - Customize
 - Change filters parameters
 - Validate
- ➔ Remove a "GROUP"
 - Group catalog
 - Select a Group
 - Delete

10.3 Stand intervention

Among the management options, the user can choose:

- to compute an evolution of the stand from a given step for a given number of years: "EVOLUTION" (this functionality is detailed in the main *CAPSIS* help on line),
- to compute an intervention (pruning, thinning, clearing, etc.) or a perturbation (Fire effects, etc.): "INTERVENTION",
- to export the current step in a given format: "EXPORT" (this functionality will be detailed in the next chapter).

In the case of an "EVOLUTION", the model calculates different steps and links them after the starting step. These new steps will have different dates. In the case of an "INTERVENTION" the user has to parameterize the "INTERVENTION". A new step is added after the chosen step, carrying the stand after "INTERVENTION" (Figure 49).

Viewers can give a representation of the stand under a given project step. This representation can be graphical (maps, distribution) or not (text). Graphical outputs can mix data extracted from several steps of one or several projects. These representations can be graphical (curves, histograms, scatter plots...) or not (tables, text...).

10.3.1 Interventions

Fire managers use mostly thinning and pruning, as canopy fuel treatment. Among the variety of thinning possibilities available in *CAPSIS*, it is possible to simulate a thinning that respaces stems or crowns. It is thus possible to simulate fuel-break according to French recommendations (ie, a distance of 3 m between crowns). Pruning is also available. Generally, interventions are applied to a group of trees or to a spatial location, which can be defined with a variety of criteria. For example, the fuel-break presented on Figure 49 was build with a respacing of crowns at 3 m from an initial stand with 800 stem/ha.

10.3.2 Fire perturbation

Fire perturbation is a specific case of "INTERVENTION" on the vegetation stand. This functionality enables to calculate the fire impacts on the vegetation objects and namely on trees. Two main options are available:

- Using the outcomes of the *FIRETEC* fire propagation model. This option requires exporting first the vegetation scene in order to run a *FIRETEC* simulation (see next chapter). The result of a fire spread in terms of fire effects can be computed, as a

function of different parameters (intensity and residence time, rate of spread and residence time, etc.). It results in a new step or scenario in stand life.

- Using some published empirical models relating fire behaviour parameters to fire effects on trees. This second option is the only one presented below. The empirical models described below can thus be used to assess the fire severity parameters of each tree (crown scorch/kill height and volume, cambium damage probability, mortality probability, etc). The user can select the empirical model he wants for crown damage, cambium damage and mortality probability through combo boxes.

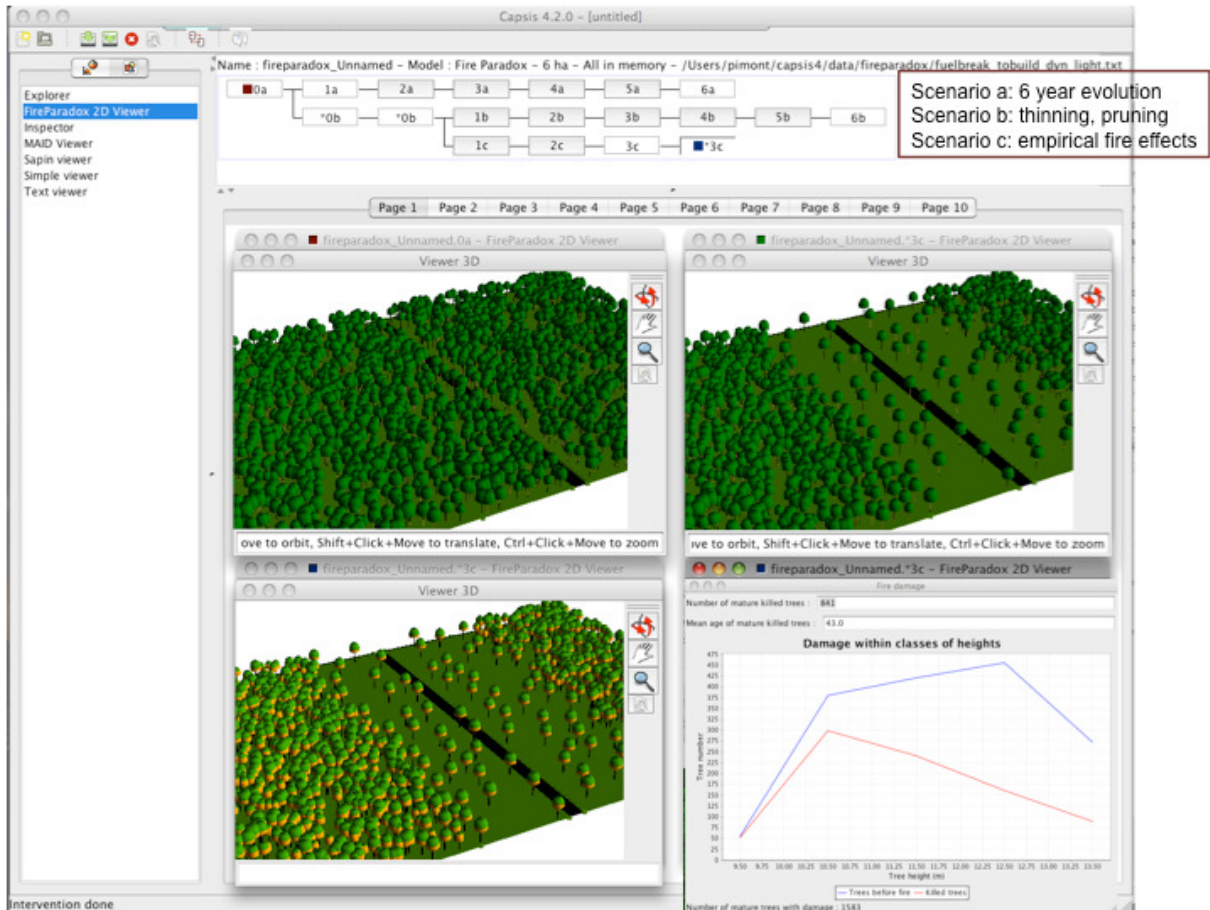

Figure 49: Project manager with 3 scenarios in an Aleppo pine stand separated by a road (in black). The top part represents the different steps in year in the different scenarios, starting from a same initial stand (0a), visualized below (top left 3D viewer). The different scenarios are:

- a: natural evolution during 6 years of the stand,
- b: understorey clearing and tree thinning (5 m between crowns) on a 100 m wide zone, followed by 6 years of evolution
- c: understorey clearing and tree thinning (5 m between crowns) on a 100 m wide zone, followed by 3 years of evolution and a fire (750 kW/m)

Damage from the fire can be seen on bottom left 3D viewer, as well as some statistics on the tree that died (in red), compared to their original number (in blue), by class of diameter (bottom right).

10.3.2.1 Fire damage to cambium (empirical models implemented)

Two empirical models can provide cambium mortality criterion, based on bark thickness and fire behaviour standard characteristics. The first one was proposed by Peterson and Ryan (1986) [5], derived from a simplified conduction model:

- Cambium mortality is assumed and the tree is killed when residence time (min) superior to $t_{kill} = 2.9BT^2$, where BT is the bark thickness of the tree (in cm).

More recently, Bova and Dickinson (2005) [6] proposed the following criterion, derived from dimensional analysis and experiments:

- Tree death by cambium mortality is considered when bark thickness (mm) is lower to $0.2I^{0.20}\tau^{0.64}$, where I is the fire intensity (kW/m) and τ the residence time (s) of the fire. Preliminary works with Jones et al. (2004) [7] physical models seem to compare better to Peterson and Ryan's model.

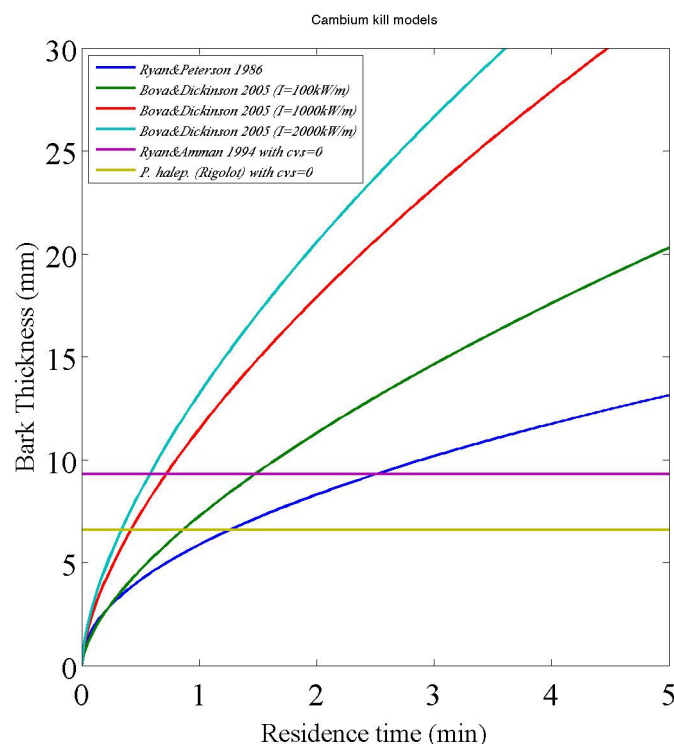

Figure 50: Bark thickness threshold for cambium mortality as a function of residence time with several empirical models

Bark thickness models

A review of relationships available for bark thickness assessment as a function of DBH was done for European species, based on the following publications (Ryan et al 1994 [8]; Pimont et al 2006 [9]; IFN 1990-04 [10]; IFN 1990-06 [11]). A selection of models was done, based on the number and range of tree sampled and the coherence with other models. The main relationships of bark thickness as a function of DBH are presented in Table 4 and Figure 51.

Table 4: Review of bark thickness of different Mediterranean species

$$BT(m) = a + b \times DBH^c (m)$$

Species	A	b	c	R ² (# trees)	References	Origin
<i>Pinus halepensis</i>	0.000424	0.076	1	0.99	[8]	8-84 cm
<i>Pinus pinea</i>	0.00559	0.067	1	0.75	[8]	8-60 cm
<i>Pinus nigra</i> subsp. <i>nigra</i>	0	0.0621	0.838	(2371)	[10, 11]	8-60 cm Alpes de Haute Provence, Southern French Alps
<i>Quercus pubescens</i>	0	0.0381	0.623	(3218)	[10, 11]	8-70 cm Alpes de Haute Provence, Southern French Alps
<i>Quercus ilex</i>	0	0.0232	0.614	(288)	[10, 11]	8-35 cm Southern French Alps

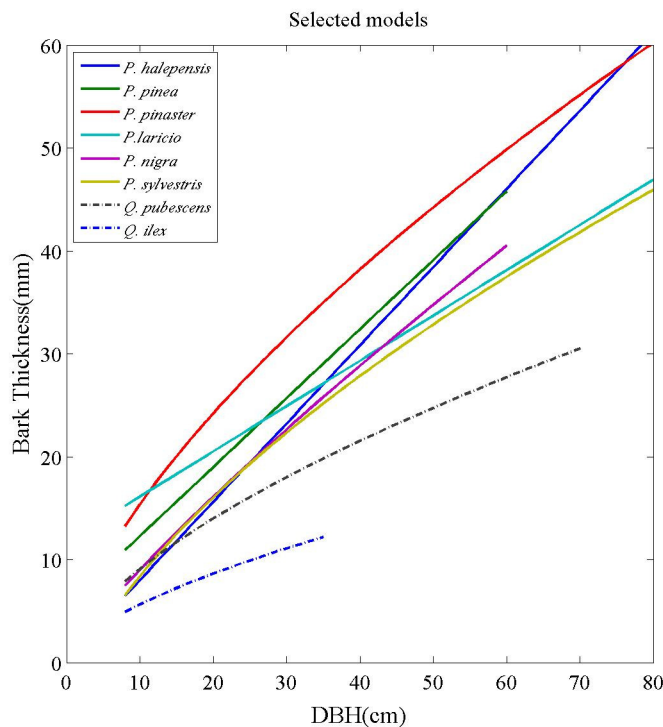

Figure 51: Bark thickness as a function of DBH for different European species

10.3.2.2 Fire damage to crown

Following Van Wagner (1977) [12], the crown scorch height (m) depends on fire intensity (kW/m), wind (m/s), ambient temperature T_{air} , and lethal temperature T_{crit} (°C):

$$h = 4.55 \frac{I^{2/3}}{(T_{crit} - T_{air})} \frac{1}{\sqrt{1 + 38 \frac{U^3}{I}}}$$

This formula was obtained from dimensional analysis, plume theory and a few field experiments. The lethal temperature depends on the type and size of organ (buds, needles).

The different models derived from this approach (Saveland and Neuenschwander 1989 [13], Finney & Martin 1992 [14], Michaletz and Johnson 2006a [15]) were included in the *FUEL*

MANAGER. The assessment of scorch or kill height is used in the software to compute the crown volume scorched (Figure 52), required for mortality models, assuming a crown shape [5] or detailed plant architecture.

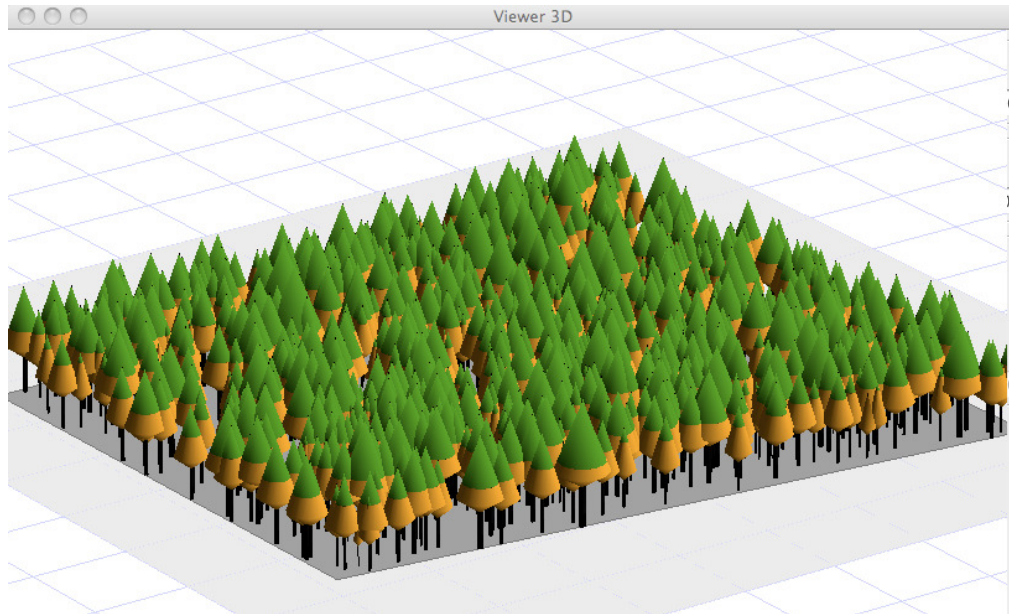

Figure 52: Simulated damage to bole and crown in a *Pinus halepensis* stand, assuming a fire intensity of 1000 kW/m and a residence time of 1 minute.

10.3.2.3 Tree mortality

A large variety of mortality models has been developed for European species (Table 5). These models were implemented in the *FUEL MANAGER*, using Crown Volume Scorched and Bark Thickness derived from the model described above. Additional mortality resulting from cambial damage was also computed based on cambium damage criteria.

Other models that integrate more directly the mechanisms involved in death were also implemented:

$$P_m = \left(\frac{CVK}{100} \right)^{\frac{\tau_c}{\tau} - 0.5},$$

, with CVK the crown volume killed (%), τ_c the critical time for cambium mortality and τ the residence time [9].

More recently, Michaletz & Johnson (2008) [16] have proposed the following model by including more processes:

$$P_m = \left(\frac{N_n}{N_t} \right)^{\delta(x_c, BT)}$$

, with N_n and N_t , respectively the number of killed buds and the total number of buds, x_c the maximum necrosis depth in bark, BT the bark thickness ($\delta=1$ if $t > 1$, else 0).

In this last model, the pipe model assumption is used to evaluate N_n/N_t with $1 - SA_n/SA_{cb}$, SA (sapwood area), evaluated with allometric relationships.

Table 5: Mortality models available for a few Mediterranean species
 $P = [1 + \exp(b_0 + b_1 x_1 + \dots + b_k x_k)]^{-1}$

Species [Source]	Variables and coefficient			
	b_0	$b_1 x_1$	$b_2 x_2$	$b_3 x_3$
<i>P. halepensis</i> [17]	1.75	-0.0385 CVS		
	-2.01	-0.0004 CVS ²	4.17 (1-e ^{-BT})	
	2.32	-0.00038 CVS ²	0.1119 DBH	-1.649 BC _{max}
<i>P. nigra subs. laricio</i> [9]	-1.13	-0.118 BLC	8.78 (1-e ^{-BT})	
	-0.222	-0.103 BLC	9.95 (1-e ^{-BT})	-1.2 BC _{mean}
<i>P. pinaster</i> [18]	7.390	-0.101 CVS	0.00381 DBH	
<i>P. pinaster</i> [9]	0.527	-3.53 BC _{mean}	9.04 (1-e ^{-BT})	
	-0.773	-0.0679 BLC	5.39 (1-e ^{-BT})	
	0.759	-0.0499 BLC	9.32 (1-e ^{-BT})	-2.71 BC _{mean}
<i>P. pinea</i> [17]	23.0	-0.253 CVS		
	33.1	-0.313 CVS	-0.1.94 BC _{mean}	
<i>P. sylvestris</i> [19]	-1.52	-0.191 CS	0.287 DBH	
	3.33	-0.187 CS	3.31 BT	
Generic [20]	-1.94	-0.000535 CVS ²	6.32 (1-e ^{-0.394BT})	
<i>Quercus suber</i> [21]	1.682	0.901 BT	-0.0145 minBLC	-0.042 DBH

BC = bark char class [22], 4 quadrants mean or max, BT = bark thickness (cm), CS = charred stem (%), CVS = crown volume scorched (%), DBH = diameter at breast height (cm), BLC=bole length charred (%).

The models implemented in the *FUEL MANAGER* illustrate the range of fire sensitivity of Mediterranean species (Figure 53).

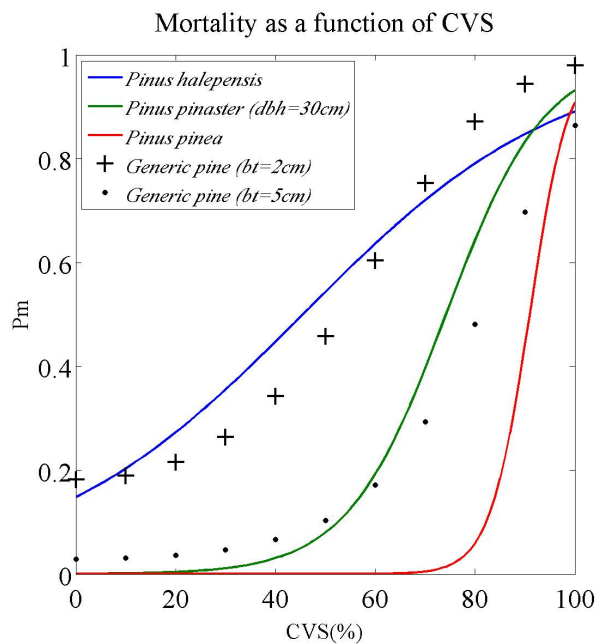

Figure 53: "Generic pine" is Ryan and Amman's model.

10.4 Session saving and opening

A Session is a collection of Projects. Several projects can be simultaneously opened, then individually saved or in a whole session. In this case, projects are still saved individually but a session file is also saved. Opening the session file will later re-open all the projects.

- ➔ To save a session on disk:
 - File > Save As Session
 - Choose a location and file name (free file extension)
 - Validate
- ➔ To open a session from disk:
 - File > Open Session
 - Select the file containing the session in the file system
 - An overview shows information of the selected session / file
 - Validate

11 FIRE MODELS EXPORTATION

One of the main objectives of the application is to automatically build input files for both 2D and 3D fire behaviour models. The software must enable to create and visualise input files based on the selected scene for fire behaviour models and simulations.

At the moment, only the *FIRETEC* exportation is available under the *CAPSIS* interface. An export to WFDS is being prepared.

11.1 *FIRETEC* Model

FIRETEC is a coupled atmospheric transport/wildfire behaviour model being developed at Los Alamos National Laboratory, and is based on the principals of conservation of mass, momentum, and energy. *FIRETEC* is a transport formulation that uses a compressible-gas formulation to couple its physics based wildfire model with the motions of the local atmosphere.

This model is written in FORTRAN 77 [23].

FIRETEC model is using 4 input binary files:

- `treessrhof.dat`: containing bulk densities ($\alpha\rho$)
- `treesss.dat`: containing fuels thickness ($2/\sigma$)
- `treessmoist.dat`: wet mass / dry mass
- `treessfueldepth.dat`: fuels height in the mesh

Where

- SVR (Surface-to-Volume Ratio) = σ
- MVR (Mass-to-Volume Ratio) = ρ
- VF (Volume Fraction) = α

The *FIRETEC* scene is defined by its dimensions and its cells size (generally 2m * 2m * 2m). Under *CAPSIS*, each fuel on the *Fire Paradox* scene have a crown description with a cells size (25 cm * 25 cm * 25 cm).

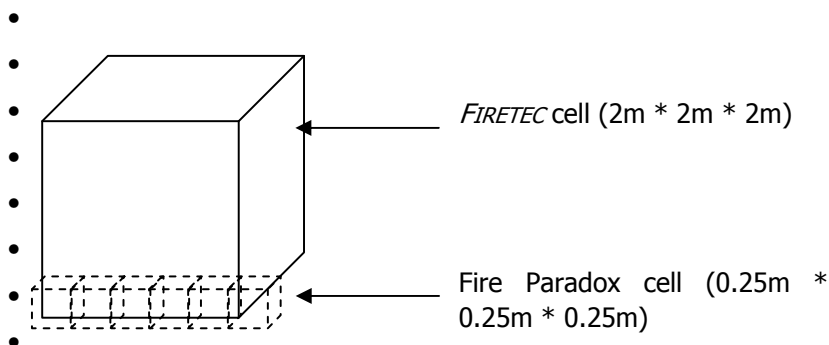

11.2 Exportation procedure

An export has been developed in the *FUEL MANAGER*, in order to build the files for the *FIRETEC* model. The *FIRETEC* matrix is generated, according to the dimension of the portion of the scene that should be exported, mesh size and stretching parameters. Then the 3D Matrix of each vegetation object in the scene are built and merge into the *FIRETEC* matrix.

- ➔ When a vegetation scene is ready to be exported, click on "OK" on the main interface of the *FIRE PARADOX FUEL MANAGER* (Figure 47). You are back to the project creation screen of *FIRE PARADOX* model under *CAPSIS*.
- ➔ Click on "OK" again.

On the main *CAPSIS* interface, you can see the initial root step (0a) of your project, containing your initial scene.

- ➔ Left click on this root step
- ➔ Select "Export".

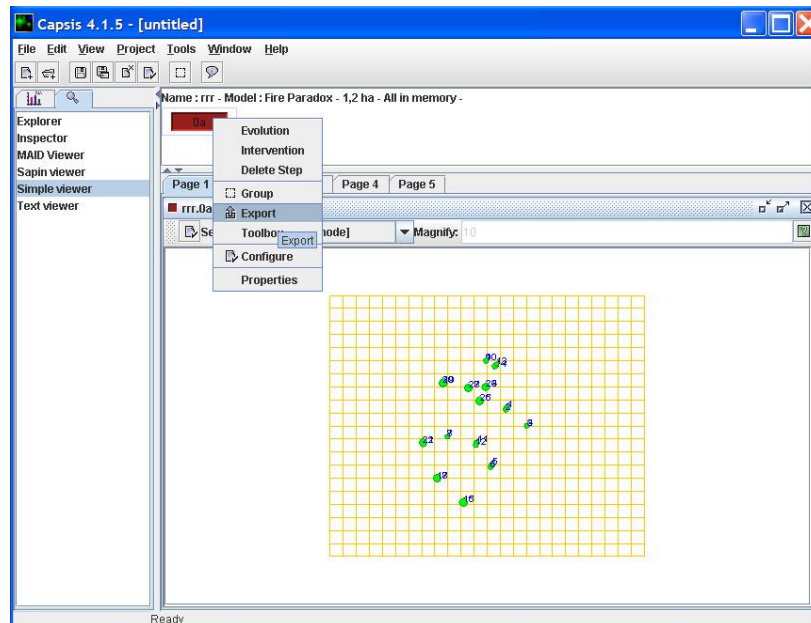

Figure 5: EXPORT choice on CAPSIS main interface

- ➔ Choose the "**FireTec MonoFuel Export**" format in the list.
- ➔ Choose a target folder name to store the exportation files results.
- ➔ "Browse" button enables to explore your computer hard disk.
- ➔ Click on "OK".

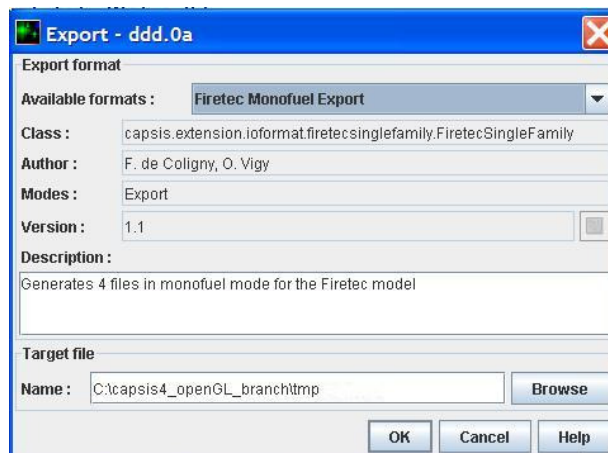
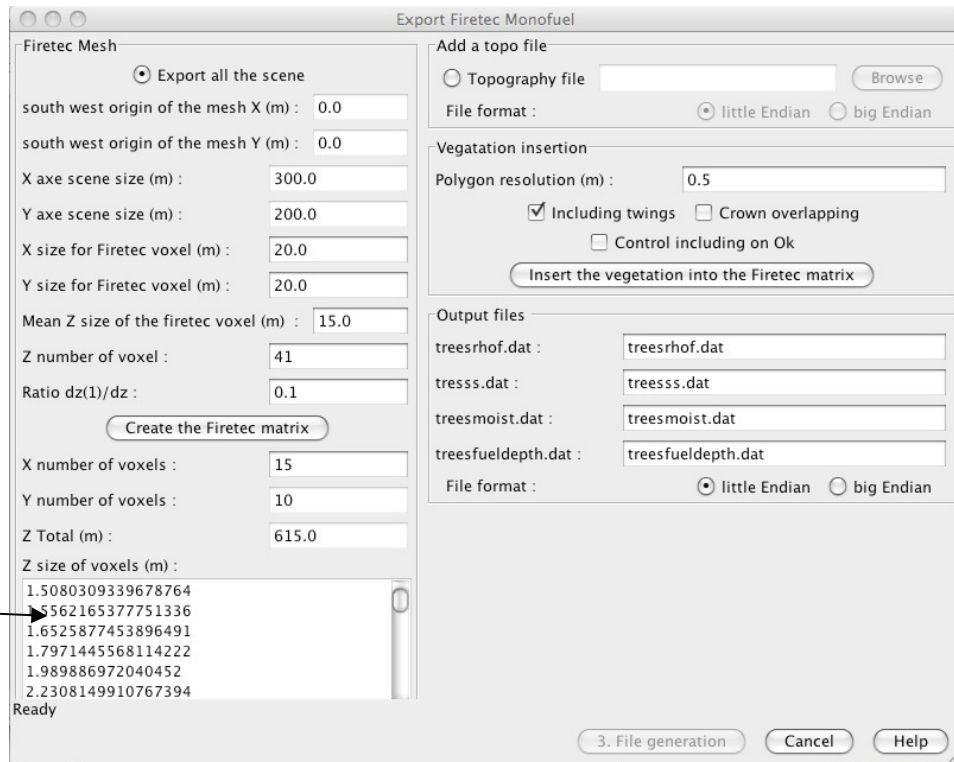

Figure 54: Export format and folder name choice

Then the export process includes 3 steps:

1. STEP 1: Creation of the *FIRETEC* matrix

- ➔ Enter *FIRETEC* mesh and voxels sizes for X and Y axes.
- ➔ Enter *FIRETEC* number of voxels on Z axe.
- ➔ Click on "Create the *FIRETEC* matrix".



Results of the creation of the *FIRETEC* matrix

Figure 55: *FIRETEC* Export Interface. The left column is dedicated to *FIRETEC* mesh computation. The right column contains the options available for export (inclusion of a topography, Resolution of the 3D Matrix of Fuel LayerSets, etc.) and file names.

2. STEP 2: Insertion of the vegetation into the *FIRETEC* matrix

- ➔ Click on "Insert the vegetation into the *FIRETEC* matrix"

3. STEP3: Generate *FIRETEC* input files

- ➔ Click on "3. File generation".
- ➔ A "Control including" check box permits to have a visual control on the *FIRETEC* mesh merging with crown description grids.

12 FIRE PARADOX FUEL DATABASE MANAGER

Data related to fuel descriptions are stored in the *FIRE PARADOX FUEL* database implemented by P13-WSL partner. This database is now located on P05-EFI server in Finland. *FIRE PARADOX FUEL* database is a facility of the *FIREINTUITION* platform. *FIRE PARADOX FUEL MANAGER* needs a remote access through out an Internet connection. A set of dialog windows have been implemented to manage the interactions between the *FIRE PARADOX FUEL* Database and the *FIRE PARADOX FUEL MANAGER*.

12.1 Database Connection and User Rights

For security reasons, the database manager access is protected by login and password. Three different right levels have been created:

- *Administrator*: all rights.
- *Teams*: creation and modification rights on team's data, consultation right on other team's data.
- *Visitor*: consultation rights only.

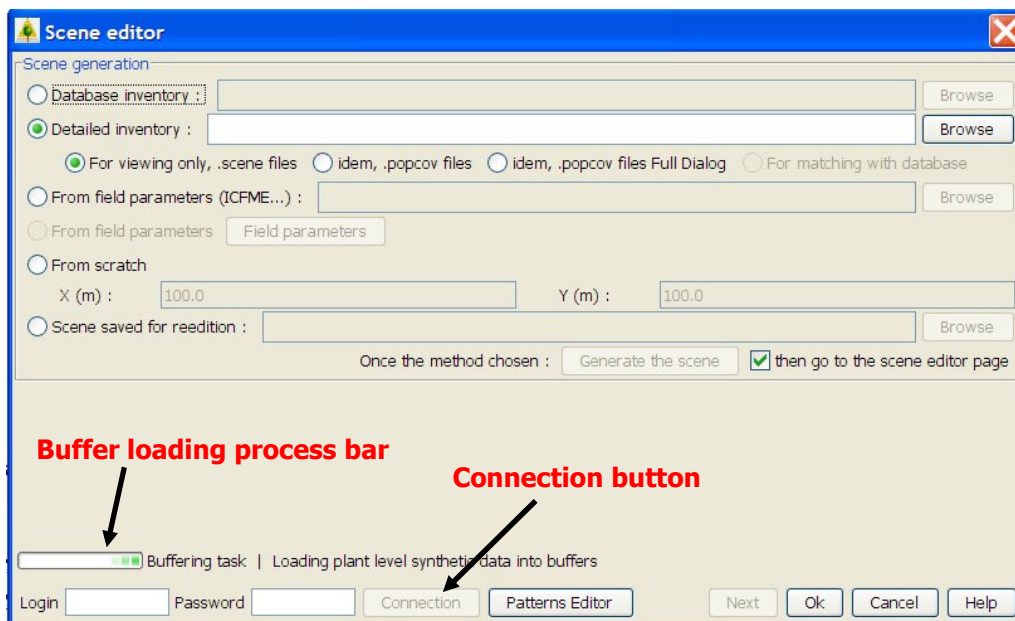

Figure 56: Fire Paradox Fuel database connection

To access the database manager menu, wait the end of the buffer loading process (species, teams, plant level synthetic data, layer level synthetic data) and then enter your "login" and "password" at the bottom on the main *Fire Paradox* "Scenes' editor" interface. Click on the "Connection" button.

12.2 Available functionalities: main menu

FIRE PARADOX FUEL database aims at storing different categories of fuels that can be displayed in *FIRE PARADOX FUEL MANAGER* for building vegetation scenes. Three fuel categories are considered:

- Plants
- Layers
- Samples

Note that these fuel categories may be either virtual or measured.

Fuels descriptions are provided by teams (mostly *FIRE PARADOX* partners) and are carried out in the field on sites that can be geographically located. "Team" and "Site" are two levels of fuel data organization stored in the database.

Each vegetation object (individual plants or Fuel LayerSet) can be associated to a detailed representation of its 3D fuel structure, so that it can be exported to any kind of fire models that use an explicit 3D representation of the fuel. This structure is based on a description of the item in small voxels. By small, we mean significantly smaller than the item size, so that the item 3D structure is reasonably well described. This size will depend on the method use to fill the voxels (allometric tree models, measured sample, etc. see below). The voxels in the 3D Matrix of a fuel item contain different local properties of the voxel, including its fuel volume (m³), its live and dead fuel biomasses (kg), its surface area (m²) and live and dead fuel water mass (kg).

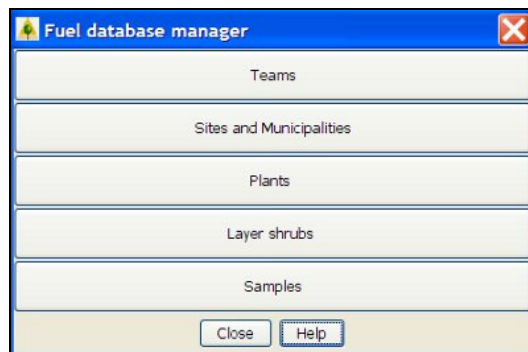

Figure 57: FIRE PARADOX FUEL DATABASE MANAGER main menu

12.3 Teams' Editor (Administrator rights)

A "Team" is a *FIRE PARADOX* partner involved in fuel description field and laboratory works. Team complete edition is available only for user *ADMINISTRATOR*.

12.3.1 Teams' List

All team objects stored in the database appear in a list. This list contains the team name and the mention if the team is deactivated or not.



Figure 58: Team list

"Modify": to modify an existing team

"Add": to add a new team

"Desactivate/Reactivate": to deactivate or reactivate an existing team

"Close": to close the window

12.3.2 Create a new Team

- ➔ To create a new team, click on the "Add" button.



Figure 59: Team creation

- "Save in the database": to save modifications and close the window
- "Cancel": to cancel modifications and close the window

Note that "Team code" and "Password" are compulsory fields.

The team code and password will be useful to allow the connection to the database management.

12.3.3 Update a team

- ➔ To update a team, click on the "Modify" button.

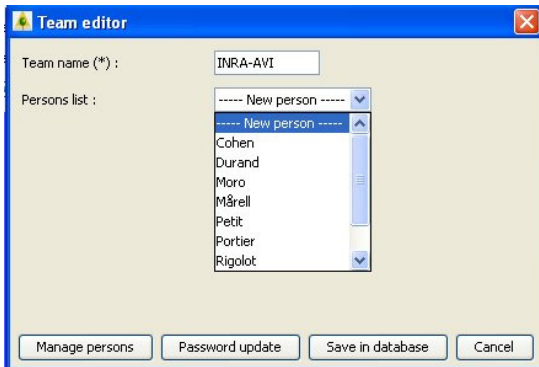

Figure 60: Team update

"Manage persons": to add or update a person name.

"Password update": to modify the team password

"Save in the database": to save modifications and close the window

"Cancel": to cancel modifications and close the window

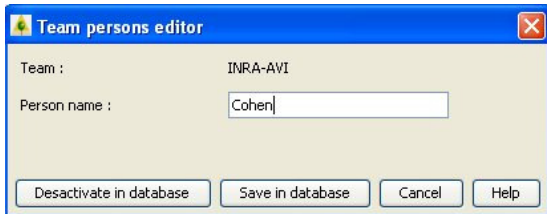

Figure 61: Team person update

• "Deactivate in the database": to deactivate the person

• "Save in the database": to save modifications and close the window

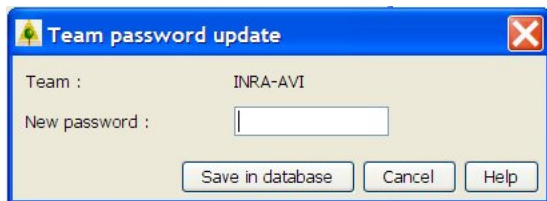

Figure 62: Team password update

• "Save in the database": to save the new password and close the window

Note that *ADMINISTRATOR* can update a team password without entering the older password

12.3.4 Deactivate a Team

- ➔ To deactivate a team, select it in the team list and click on "Deactivate/Reactivate".

When the team data appears on the teams' editor screen, click on "Deactivate in the database".

The team object won't be physically deleted in the database; it will be only logically deactivated.

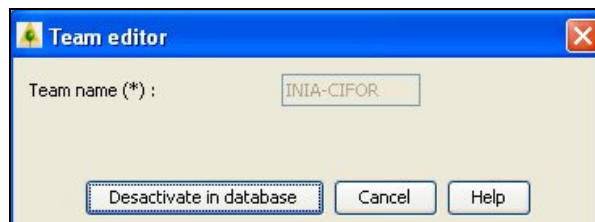

Figure 63: Team desactivation

12.3.5 Reactivate a Team

- ➔ To reactivate a team, select it in the teams' list and click on "Desactivate/Reactivate".

When the team data appears on the teams' editor screen, click on "Reactivate in the database".

12.4 Teams' Editor (Team rights)

A **Team** is not allowed to update other teams data, but can manage its own data as: password and persons list.

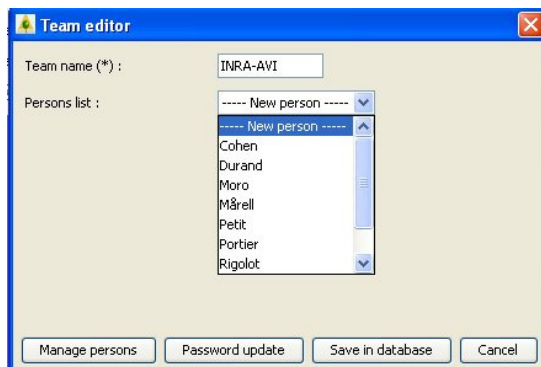

Figure 64: Team person management

- "Manage persons": to add or update a person name.
- "Password update": to modify the team password
- "Save in the database": to save modifications and close the window
- "Cancel": to cancel modifications and close the window

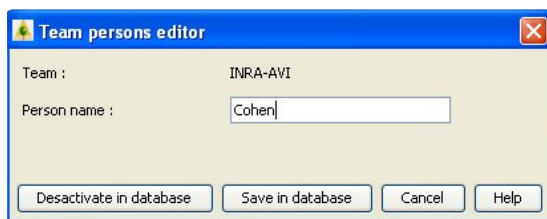

Figure 65: Team person update

- "Desactivate in the database": to deactivate the person
- "Save in the database": to save modifications and close the window



Figure 66: Team password update

Control buttons are:

- "Save in the database": to save the new password and close the window
- "Cancel": to cancel modifications and close the window

Note that the old password is required! If you have lost it, contact the database ADMINISTRATOR.

12.5 Sites' Editor

A **Site** is the location where destructive fuel sampling has been carried out to characterize individual plant or particle fuel properties.

12.5.1 Sites' List

All site objects stored in the database appear in a list. This list contains the country, the municipality, the site code and the mention if the site is deleted or not.

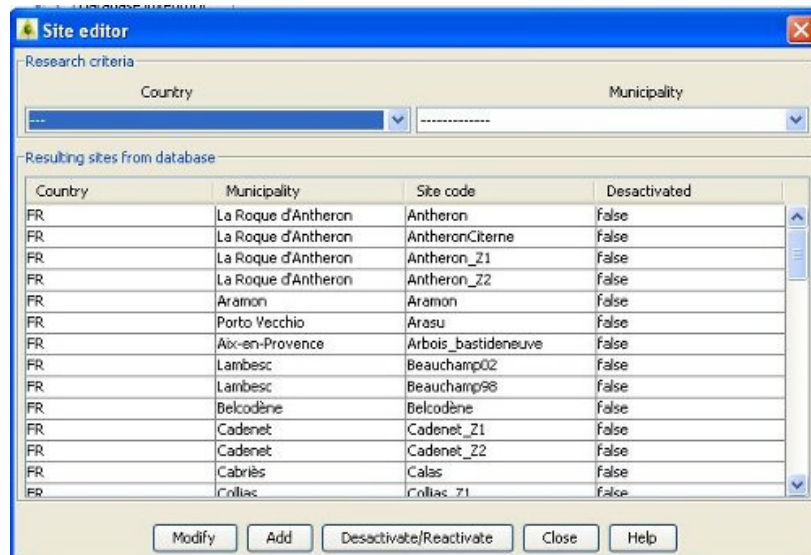

Figure 67: Site list

For research purposes, the sites' list can be restricted with a country or a municipality selection in the "Research criteria" frame.

Control buttons are:

- "Modify": to modify an existing site.
- "Add": to add a new site (only available for ADMINISTRATOR).
- "Desactivate/Reactivate": to desactivate or reactivate an existing site (only available for ADMINISTRATOR).
- "Close": to close the window.
- "Help": to get help about this screen.

12.5.2 Create or Update a Site

- ➔ To create a new site, click on the "Add" button.

- ➔ To modify a site, select it in the sites' list and click on the "Modify" button.

The screenshot shows a 'Site editor' window with two main sections: 'A - Site location' and 'B - Environmental description'.
 Section A includes: Site code (text box with 'Beauchamp98'), Country (dropdown with 'FR'), Municipality (dropdown), Latitude (degree) (text box with '0.0'), Longitude (degree) (text box with '0.0'), and Elevation (m) (text box with '0.0').
 Section B includes: General description (text box), Topographic position (dropdown), Slope type (dropdown with 'Flat') and Slope value (degree) (text box with '0.0'), Aspect class (dropdown) and Aspect value (degree) (text box with '0.0'), and three Dominant taxa (dropdowns).
 At the bottom, there are buttons for 'Events management', 'Save in database', 'Cancel', and 'Help'.

Figure 686: Site creation or modification

Data verifications before validation are:

- "Site code" is compulsory.
- "Municipality" is compulsory.
- "Latitude" has to be numerical and between 0 and 360 degrees.
- "Longitude" has to be numerical and between 0 and 90 degrees.
- "Altitude" has to be numerical.
- "Slope value" has to be numerical and between 0 and 360 degrees.
- "Aspect value" has to be numerical and between 0 and 360 degrees.

Available values for "Topographic position" are:

- Summit
- HighSlope
- MidSlope
- LowSlope
- ValleyBottom
- Plateau

Available values for "Slope type" are:

- Flat
- Weak
- Steep
- Variable

Available values for "Aspect class" are:

- N
- NE
- E
- SE
- S
- SW
- W
- NW
- PLAIN

Control buttons are:

- "Municipality editor": to add or to modify a municipality.
- "Events management": to manage the site event list.
- "Save in the database": to save modifications and close the window.
- "Cancel": to cancel modifications and close the window.
- "Help": to get help about this screen.

12.5.3 Manage site events

It is possible to store a list of event attached to each site. An event is defined with a type and dates.

Available types are:

- Residual_Fertilization
- RestorationWork
- SalvageLogging
- LoggingDamage
- StumpWooding
- Thinning
- Insects_and_Disease
- Pruning
- SelectionCut
- IceStorm
- FuelTreatment
- PrescribedFire
- Avalanche
- Flood
- Grazing
- MechanicalTreatment
- SilviculturalOperation
- Clearcut
- NaturalEvent
- WildfireCrown
- Fertilization
- Reseeding
- WildfireSurface
- Windthrow
- Pasture
- WildfireGround
- Landslide

- Wildfire
- LandUse
- UndefinedEvent
- Mastication
- GrassCutting
- BushClearing
- Chipping
- Lop_and_Scatter
- PileBurn
- UndefinedFuelTreatment



Figure 69: Site event list management

- "Add" to add a new event.
- "Modify" to modify an event
- "Delete": to delete an event
- "Validation": to save modifications and close the window
- "Close": to cancel modifications and close the window

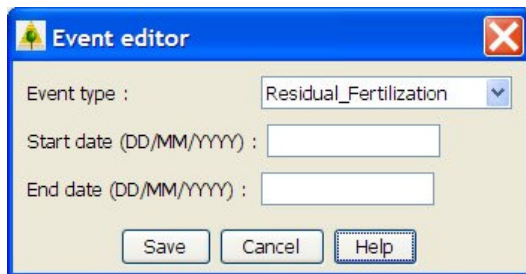

Figure 70: Site event edition

- Select the event type
- Enter starting date (DD/MM/YYYY format)
- Enter ending date (DD/MM/YYYY format)
- "Save": to save modifications
- "Cancel": to cancel modifications and close the window

12.5.4 Deactivate a Site

- ▶ To deactivate a site, select it in the sites list and click on "Desactivate/Reactivate".

When the site data appears on the "Sites' editor" screen, click on the "Desactivate in the database" button.

The object won't be physically deleted in the database; it will be only logically deactivated.

12.5.5 Reactivate a Site

- ▶ To reactivate a site, select it in the sites' list and click on the "Desactivate/Reactivate" button.
- ▶ When the site data appears on the "Sites' editor" screen, click on the "Reactivate in the database" button.

12.5.6 Municipalities' List

The **municipality** is a parameter included in the site description. In most countries, a municipality is the smallest administrative subdivision to have its own democratically elected representative leadership. All municipality objects stored in the database appear in a list. This list contains the country, the municipality name and the mention if the municipality is deleted or not.

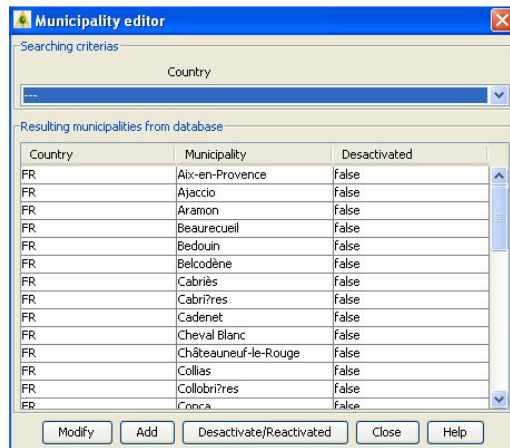

Figure 71: Municipalities' list

For research purposes, the municipalities' list can be restricted with a country selection in the "Searching criteria" frame.

Control buttons are:

- "Modify": to modify an existing municipality.
- "Add": to add a new municipality (only available for *ADMINISTRATOR*).
- "Desactivate/Reactivate": to deactivate or reactivate an existing municipality (only available for *ADMINISTRATOR*).
- "Close": to close the window.
- "Help": to get help about this screen.

12.5.7 Create or Update a Municipality

- ➔ To create a new municipality, click on the "Add" button.
- ➔ To modify a municipality, select it in the municipalities' list and click on the "Modify" button.



Figure 72: Municipality creation or modification

Data verifications before validation are:

- "Municipality name" is compulsory.
- "Country" is compulsory.

Control buttons are:

- "Save in the database": to save modifications and close the window.
- "Cancel": to cancel modifications and close the window.

12.5.8 Deactivate a Municipality

- ➔ To deactivate a municipality, select the municipality in the list and click on the "Desactivate/Reactivate" button.

When the municipality data appears on the municipalities' editor screen, click on the "Desactivate in the database" button.

The object won't be physically deleted in the database; it will be only logically deactivated.

12.5.9 Reactivate a Municipality

- ➔ To reactivate a municipality, select the municipality in the municipalities' list and click on "Desactivate/Reactivate".

When the municipality data appears on the municipalities' editor screen, click on "Reactivate in the database".

12.6 Fuels' Editor (Fuel Plants)

The **Fuel Editor** is a functionality of the *FIRE PARADOX FUEL MANAGER* implemented to manipulate three fuel categories: fuel samples, fuel plants and fuel layers. An individual **Fuel Plant** is a vegetation object which may be either a tree, a shrub, or a grass represented on the vegetation scene and fully described as a fuel in the *FIRE PARADOX FUEL* database. It may be either a measured plant corresponding to a real plant measured in the field, or a virtual plant, created with the *FIRE PARADOX FUEL MANAGER*. A virtual plant may differ from a real one either by its shape, by the distribution of voxels (fuel samples) within its shape, by the values of one or several fuel parameters (*e.g.* mean of several samples).

12.6.1 Fuel Plants' List

When selecting the "Plants" button on the Fuel database manager (Figure 73a), the plant list window is opened (Figure 73b).

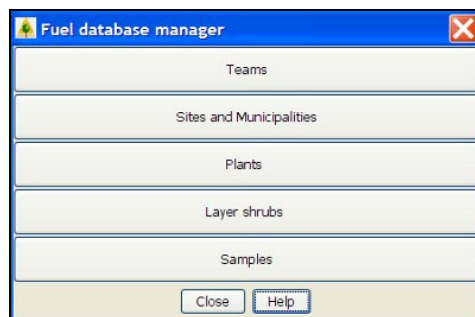

Figure 73a: Fuel database manager window

All plants stored in the database appear in a list. This list contains:

- species name; plant height in meters
- plant crown base height in meters
- plant crown diameter in meters
- plant origin (measured or virtual)
- mention if the plant is validated or not, and if the plant is deleted or not.

Team	Site	Species	Height (m)	Crown base H ...	Crown D (m)	Origin	Validated	Desactivated
INRA-AVI	null	Buxus semperviv...	0.75	0	0.25	Virtual	✓	
INRA-AVI	null	Buxus semperviv...	0.75	0	0.5	Virtual	✓	
INRA-AVI	Antheron	Rosmarinus offic...	0.25	0	0.4	Measured		
INRA-AVI	Antheron	Rosmarinus offic...	0.25	0	0.6	Measured		
INRA-AVI	Antheron	Rosmarinus offic...	0.25	0	0.6	Measured		
INRA-AVI	Antheron	Rosmarinus offic...	0.25	0	1	Measured		
INRA-AVI	Antheron	Rosmarinus offic...	0.5	0	1	Measured		
INRA-AVI	Antheron	Rosmarinus offic...	0.5	0	1	Measured		
INRA-AVI	Antheron	Rosmarinus offic...	0.5	0	1.25	Measured		
INRA-AVI	Antheron	Rosmarinus offic...	0.75	0	1	Measured		
INRA-AVI	Antheron	Rosmarinus offic...	0.75	0	1.3	Measured		
INRA-AVI	Antheron	Rosmarinus offic...	1	0	2	Measured		
INRA-AVI	Antheron	Rosmarinus offic...	1	0	2.5	Measured		

Figure 73b: Fuel plants' list

The list can be restricted with selection in the research criteria's.

Control buttons are:

- "Add": to add a new plant
- "Shapes": to manage different shapes attached to a plant
- "Parameters": to enter parameters for each plant particle.
- "Validate": to check a plant data integrity in the database in order to permit its utilisation in virtual scene creation and in exportation to run a fire simulation. To be validated a plant must have a 3D shape. A validated plant cannot be modified.
- "Edit": to display plant information. Modification will be possible if the user is the owner of the fuel and if this plant is neither deactivated or validated. In the contrary, the plant will have be unvalidated or reactivated before being updated.
- "Copy": to copy an existing plant (including shapes) in a new one.
- "Deactivate/Reactivate": to denied utilisation of a plant without deleting referenced data. Deactivation is also done for all shapes attached to the fuel. Reactivate action is useful to cancel a deactivation. Only the plant will be reactivated, but not the shapes.
- "Close": to close the window.
- "Help": to get help about this screen.

12.6.2 Create or Update a Plant

- ➔ To create a new plant, click on "Add".
- ➔ To modify a plant, select the plant in the list and click on "Edit".

A plant is defined in 4 different panels:

- Team
- Site
- Simple individual
- General comments

Figure 74: Plant team panel

Figure 75: Plant comment panel

Figure 76: Plant site panel

Data verifications before validation are:

- "Team" selection is compulsory.
- "Sampling date" has to be in the following format: DD/MM/YYYY.
- "Field operator 1" selection is compulsory.
- "Site" selection is compulsory.

Figure 77: Plant simple individual panel

Data verifications before validation are:

- "Species" is compulsory.
- "Latitude" has to be numerical and between 0 and 360 degrees.
- "Longitude" has to be numerical and between 0 and 90 degrees.
- "Altitude" has to be numerical.
- "Height" is compulsory and has to be numerical.
- "Diameter" is compulsory and has to be numerical
- "Perpendicular diameter" has to be numerical
- "Tree cover" has to be numerical and between 0 and 100 %.

Available values for openness are:

- Open
- Closed

Control button are:

- "Save in the database": to save modifications on the plant.
- "Cancel": to cancel modifications and close the window.
- "Help": to get help about this screen.

12.6.3 Shapes creation for a measured plant

To be used in the *FIRE PARADOX FUEL MANAGER*, the measured plant has to be described as a 3D crown shape. Several methods are available for creating a shape.

a) Cube method

The spatial distribution of fuel particles within the crown is modelled by three types of cubes (voxels) called top "T", centre "C" and base "B". Zones composed of the same type of voxel have similar volume fractions or biomass for the particles. First a sample composed of each type of voxel (T/C/B) measured in the field has to be describe (chapter 12.6.3.1). Then a 2D (chapter 12.6.3.2) or 2*2D (chapter 12.6.3.3) or 3D shape (chapter 12.6.3.4), using voxels from the sample can be generated.

b) Cage method

First a 3D sample composed of all different voxels measured in the field has to be described (chapter 12.6.3.5). Then a 3D shape (chapter 12.6.3.6) using voxels from the sample can be generated.

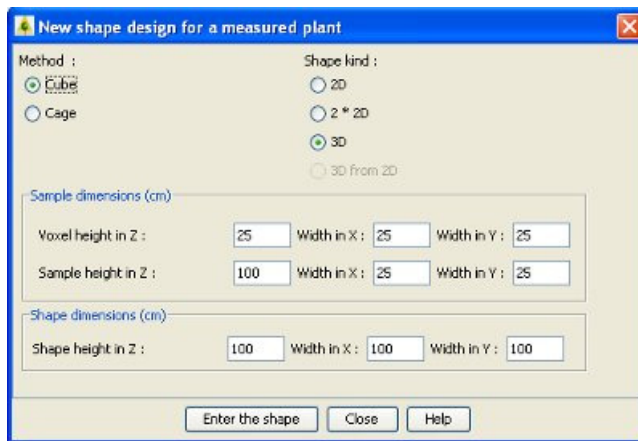

- Select the sampling method
- Choose the shape kind
- Enter the voxels and sample dimensions in cm
- Enter the shape dimensions
- "Enter the shape" to continue
- "Close" to cancel the shape creation

Figure 78: Measured plant shape creation

If the cube method is selected, only the sample height in Z is necessary.

If a sample already exists for this plant, the part "Sample dimensions" won't be enabled.

12.6.3.1 Sample creation for a measured plant (cube method)

For the creation of a plant measured by the cube method, a sample creation is compulsory. This sample is composed of a column of voxels, with 3 types represented (TOP/CENTER/BASE). The first step of this sample creation will be to define the different voxels position in column height and the second step will be to describe particles and biomasses in each type of voxel.

a) Cubes position definition

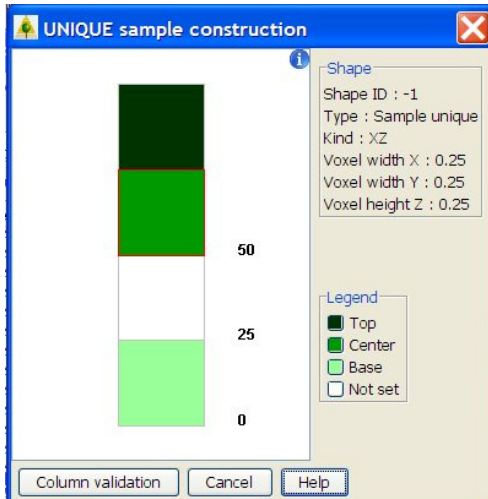

Figure 79: Measured cube method sample creation

- At the top right, a panel displays the shape information (ID, sample type, shape kind, voxels dimensions). The shape ID is still equals to -1 because the shape is not YET created in the database.
- The color legend for each type of voxel (T/C/B) is displayed in the lower panel.
- "Column validation": to be validated, the column must be composed of one COLORED voxel at least. Empty voxels at the top of the column won't be saved in the database. The column size will be automatically adjusted.

If the column is only one voxel height, the single voxel value will be TOP. If the column is 2 voxels height, voxels value will be TOP - BASE. If the column is 3 voxels height, values will be TOP - CENTER - BASE.

If the column is higher, the TOP voxel will be at the top, the BASE voxel will be at the bottom and the CENTER voxel will be centered in the middle of the column.

Only the CENTER position can be modified. If you double click on a WHITE voxel, this one will become CENTER.

TOP and BASE voxels cannot be moved from their initial position.

Each type of voxel can be removed. If you double click on a COLORED voxel, this one will become WHITE. If you double click again, the voxel will come back to its original color.

b) Particles and biomasses description

For each type of voxel, measured particle biomasses have to be filled up. In this interface, voxel type positions within the sample cannot be modified anymore.

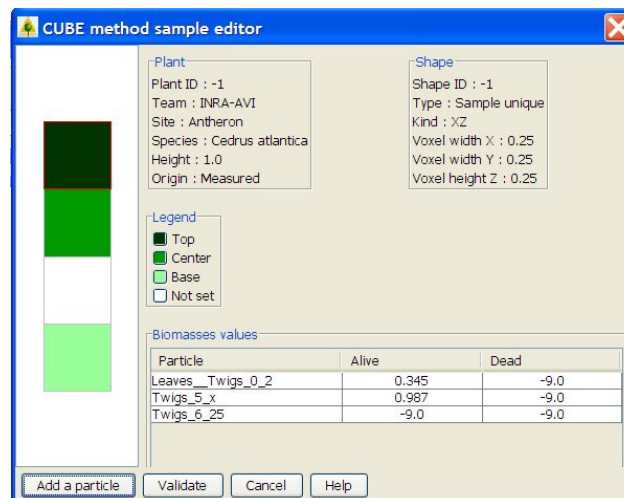

Figure 80: Measured cube method sample biomasses update

Double click to select a voxel. The selected voxel appears with a red border.

In the bottom right part of the screen, for the selected voxel, a table appears with particle names and biomass values (alive and dead). Biomass values can be modified and the unit is grams.

- ➔ biomass value = **0.0** means a measured value equals to zero.
- ➔ biomass value = **-9.0** means a missing value, NOT measured.
- ➔ biomass value = **NaN** means an existing value, NOT measured.

Click on "Add a particle" to add a new particle in the biomasses values table.

Click on "Validate" to save the sample. To be validated, at least one particle and one biomass should be filled for each type of voxel.

12.6.3.2 2D shape creation for a measured plant (cube method)

The crown shape appears in a 2D grid (X is the diameter, Z is the shape height). As this shape is created from a sample, the voxels of the sample with attached particles and biomasses will be centered in the new 2D shape.

The screen is divided into 2 parts:

- Left part for shape modification in 2D
- Right part for legend and biomasses checking

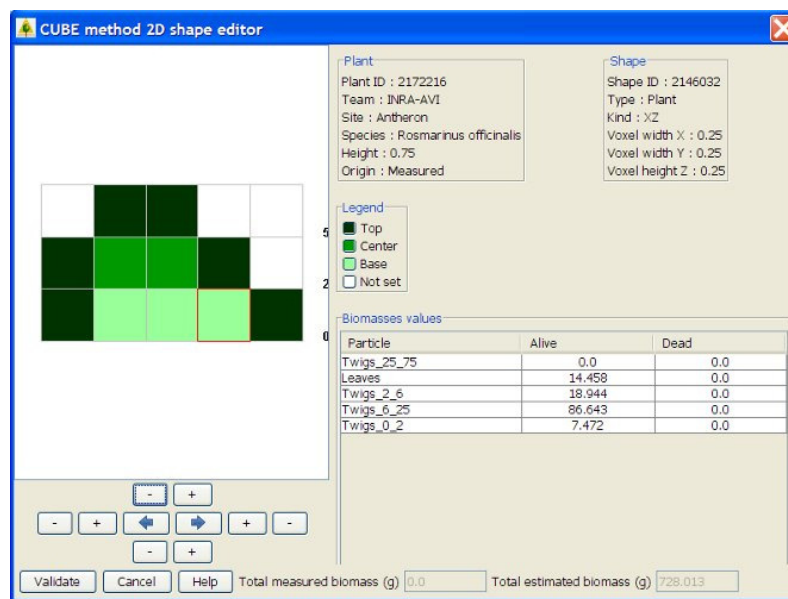

Figure 81: Measured cube method 2D shape edition

Left part:

- ➔ To change a voxel color (type), select the color in the legend and left click on the voxel. The voxel appears in the selected color with a red border.
- ➔ Existing particles and biomasses for this type of voxel appear in the bottom right part of the screen.
- ➔ To change several voxels color at the same time, draw a rectangle with the right click around the group of voxels.
- ➔ A zoom tool is available by drawing a rectangle with the left click of the mouse. A single right click zoom forward.



Decrease and increase the grid size in 4 dimensions.



Copy voxels from left to right symmetrically to Z axe.

Right part:

- Select the type of voxel to spread on the shape in the coloured squares in the legend (TOP/CENTER/BOTTOM). The selected type name appears in RED.
- A white voxel represents empty areas in the crown.
- At the bottom right part of the screen, particles list with biomasses for the selected type of voxel is displayed. Biomasses values CAN NOT be modified here. Unit is grams.

Control

- At the bottom of the screen, the total estimated biomass is automatically calculated.
- Total measured biomass from the sampling, is displayed for control.
- Click on "Validate" to save the shape in the database.
- All empty voxel rows at the right or at the top of the shape will NOT be saved. The shape size will be automatically adjusted.

NOTE: It is NOT POSSIBLE to modify biomass values or to add a new particle from this interface; you have to go back to the SAMPLE edition of the given plant.

12.6.3.3 2 * 2D shape creation for a measured plant (cube method)

The crown shape appears in 2 grids, one representing the front view (X is the diameter, Z is the shape height), the other representing the side view (X is the perpendicular diameter, Z is the shape height). If this shape is created from a sample, the voxels of the sample will be centered in the 2*2D shape.

The screen is divided in 3 parts:

- Left part for FRONT shape modification in 2D
- Central part for SIDE shape modification in 2D
- Right part for legend and biomasses checking

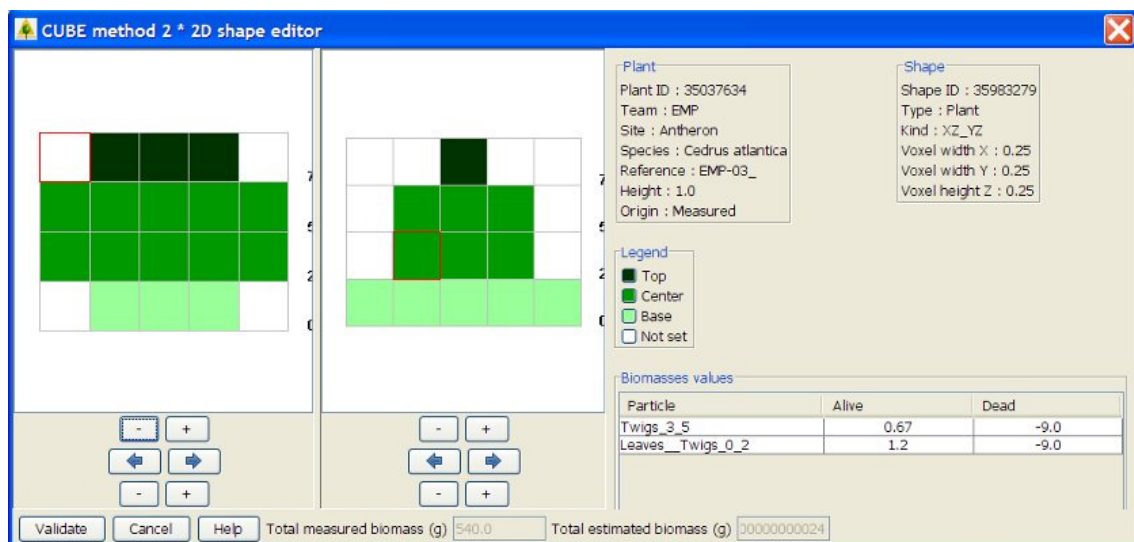

Figure 82: Measured cube method 2 * 2D shape edition

The shape creation process is the same as for the previous chapter (single 2D shape) except that both grid size widths cannot be increased.

12.6.3.4 3D shape creation for a measured plant (cube method)

A 3D shape can be generated from 2 different ways:

- By copying voxels from a sample or a 2D shape: in this case the 3D shape will be composed of voxel types TOP/CENTER/BASE
- By a rotation algorithm from 2D to 3D: in this second case, the shape will be composed of voxels, all different, with biomasses calculated from the voxel distance to the centre of the rotation axe.

a) From sample or 2D shape cubes copy

As this shape is created from a sample (or a 2D shape) the voxels of the sample (or the 2D shape) are centered in the 3D shape.

The screen is divided in 3 parts:

- Left part for 3D visualisation
- Middle part for shape modification in 2D
- Right part for legend and biomasses checking

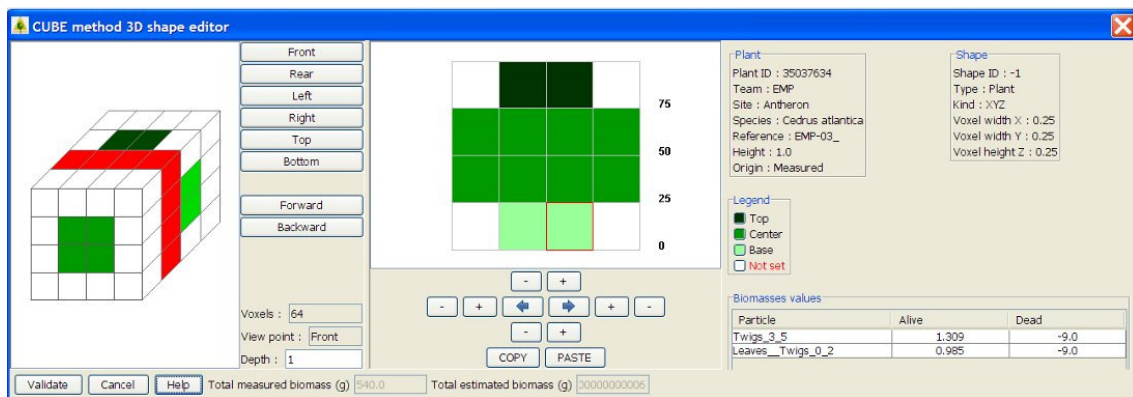

Figure 83: Measured 3D shape edition with voxel types

Left part:

The crown shape appears in 3D (X is the diameter, Y is the perpendicular diameter, Z is the shape height). The selected voxel slice (in red) appears in 2D in the grid in the central screen.

- ➔ Front/Rear/Left/Right/Top/Bottom enables to display the shape from different direction.
- ➔ Forward/Backward enables to change the voxel slice point of view.

Central part:

- ➔ To change a voxel color (type), select the color from the legend and left click on the voxel. The voxel appears in the selected color with a red border.
- ➔ Existing particles and biomasses for this type of voxel appear in the bottom right part of the screen.
- ➔ To change several voxels color at the same time, draw a rectangle with the right click around the group of voxels.
- ➔ A zoom tool is available by drawing a rectangle with the left click. A single right click zooms forward.
- ➔ COPY/PASTE is useful to copy a 2D slice of voxels in another one.



Decrease and increase the grid size in 4 dimensions.



Copy voxels from left to right symmetrically to Z axe.

Right part:

- ➔ Select the type of voxel to spread on the shape in the coloured square in the legend (TOP/CENTER/BOTTOM). The selected type name appears in RED.
- ➔ A white voxel represents empty areas in the crown.
- ➔ At the bottom right part of the screen, particles list with biomasses for the selected type of voxel is displayed. Biomasses values CAN NOT be modified here. Unit is grams.

Control:

- ➔ At the bottom of the screen, the total estimated biomass is automatically calculated.
- ➔ Total measured biomass from the sampling, is displayed for control.
- ➔ Click on "Validate" to save the shape in the database.
- ➔ All empty voxel rows at the right or at the top of the shape will NOT be saved. The shape size will be automatically adjusted.

NOTE: It is NOT POSSIBLE to modify biomasses values or to add a new particle from this interface; you have to go back to the SAMPLE edition in the same plant.

b) From 2D shape voxels rotation algorithm

The screen is divided in 3 parts:

- Left part for 3D visualisation
- Central part for shape modification in 2D
- Right part for legend and biomasses update

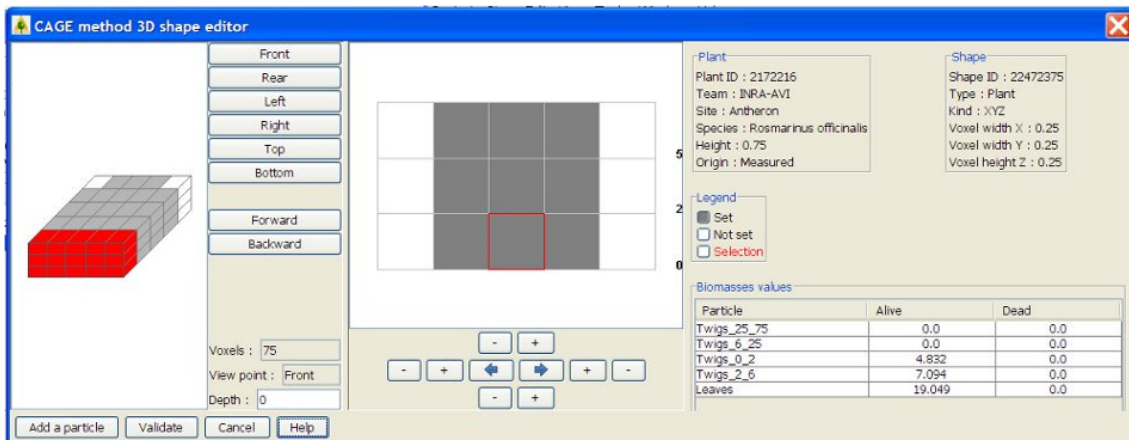

Figure 84: Measured 3D shape edition without voxel types

Left part:

The crown shape appears in 3D (X is the diameter, Y is the perpendicular diameter, Z is the shape height). The selected voxel slice (in red) appears in 2D in the grid in the central screen.

- ➔ Front/Rear/Left/Right/Top/Bottom enables to display the shape from different directions.
- ➔ Forward/Backward enables to change the voxel slice point of view.

Central part:

- ➔ To change a voxel status (set or not set), select the color from the legend and left click on the voxel. The voxel appears in the selected color with a red border.

- ➔ If biomasses already exist for this voxel, it appears in the bottom right part of the screen.
- ➔ To change several voxels color at the same time, draw a rectangle with the right click around the group of voxels.
- ➔ A zoom tool is available by drawing a rectangle with the left click of the mouse. A single right click zooms forward.



Decrease and increase the grid size in 4 dimensions.



Copy voxels from left to right symmetrically to Z axis.

Right part:

- ➔ Select the type of voxel to spread on the shape in the coloured square in the legend (SET/NOT SET). The selected type name appears in RED.
- ➔ A white voxel represents empty area in the crown.
- ➔ At the bottom right part of the screen, particles list with biomasses for the selected voxel is displayed. Biomasses values can be modified here. Unit is grams.
 - Biomass value = **0.0** means a measured value equals to zero.
 - Biomass value = **-9.0** means a missing value, NOT measured.
 - Biomass value = **NaN** means an existing value, NOT measured.

Control:

- ➔ At the bottom of the screen, the total estimated biomass is automatically calculated.
- ➔ Total measured biomass from the sampling, is displayed for control.
- ➔ Click on "Add a particle" to add a new particle.
- ➔ Click on "Validate" to save the shape in the database.
- ➔ All empty voxel rows at the right or at the top of the shape will NOT be saved. The shape size will be automatically adjusted.

12.6.3.5 Sample creation for a measured plant (cage method)

For sampling cage method, only 3D sample and shape can be created.

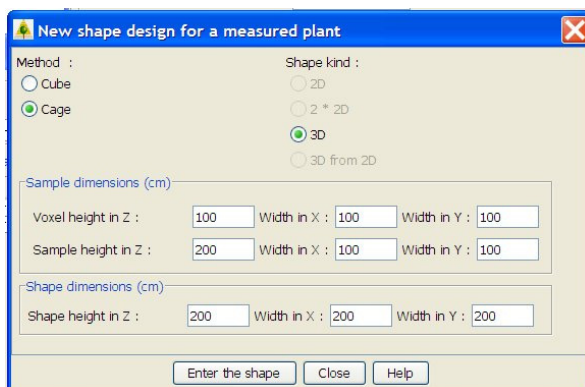

- Select the cage method
- Only 3D shape kind is enabled
- Fill up the voxel and the 3D sample dimensions (usually this sample dimension are 2m * 1m * 1m with 1m³ voxel size)
- Fill up the 3D shape dimensions

Figure 85: Shape creation for a measured plant (cage method)

Then for each voxel of the 3D sample, particles and biomasses have to be filled up. The procedure and screenshots are the same as in chapter 12.6.3.4 part b)

12.6.3.6 3D shape creation for a measured plant (cage method)

When the 3D sample is validated, the 3D shape biomasses are automatically calculated. Biomasses values are the average of all sample voxels.

Then for each voxel of the 3D shape, particles and biomasses can be modified. The procedure and screenshots are the same as in chapter 12.6.3.4 part b)

12.6.4 Create shapes for a virtual plant

For virtual plants, only a 3D shape can be created. It is possible to use a "virtual sample" composed of T/C/B voxels as in cube method.

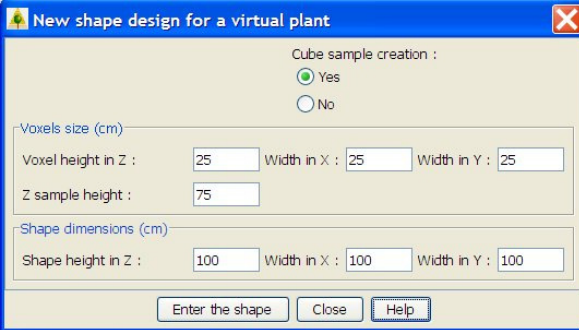

- Select the sample creation option (Yes/No)
- Fill the voxel dimensions
- If sample creation option is selected, the sample height has to be filled up
- Fill up the 3D shape dimensions

Figure 86: Shape creation for a virtual plant

If the sample creation is selected, first a "virtual" voxel sample will be created (Refer to chapter 12.6.3.1). Then a 3D shape will be generated, composed of the sample voxels (Refer to chapter 12.6.3.4 part a).

If the sample creation is NOT selected, each voxel of the 3D shape will be different and particles and biomasses can be modified. The procedure and screenshots are the same as in chapter 12.6.3.4 part b)

12.6.5 Create or Update Plant Particles Parameters

Before plant validation, parameters have to be filled up, at the plant level, for each particle defined in the shape voxels.

Parameter list is:

- MVR: Mass-to-Volume Ratio which correspond to the density (kg/m^3)
- SVR: Surface-to-Volume Ratio used to evaluate the thickness of the particle (m^2/m^3)
- AC: Ash content (g/100g)
- MC: Moisture Content at a given time (%)
- HCV: High Calorific Value (KJ/Kg)
- Size: Size of the particle such as the length of needles (mm)

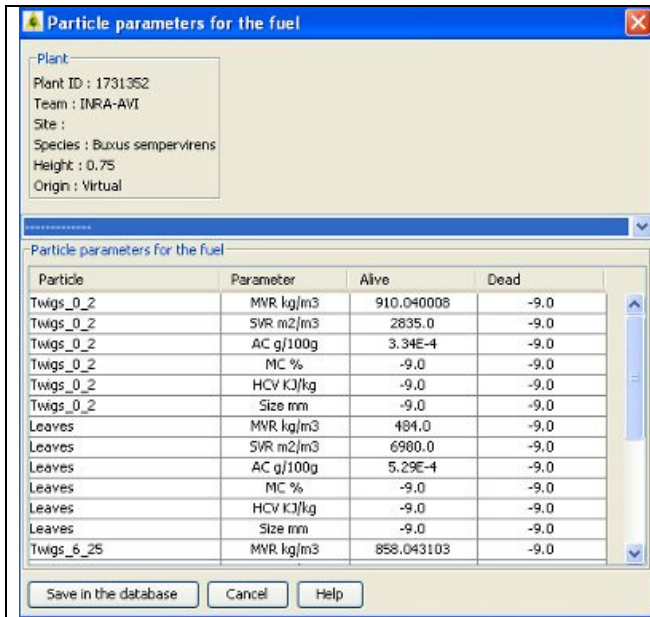

Figure 87: Plant particle parameters update

- A parameter name can be selected to reduce the value table size.
- Enter parameter values for ALIVE and DEAD particles:
 value = **0.0** means a measured value equals to zero.
 value = **-9.0** means a missing value, NOT measured.
 value = **NaN** means an existing value, NOT measured.
- "Save in the database": to save modifications

12.6.6 Deactivate a plant

- ➔ To deactivate a plant: select the plant in the plants' list and click on "Desactivate/Reactivate" button.

When the fuel data appears on the fuels' editor screen, click on "Desactivate in the database".

The object won't be physically deleted in the database, it will be logically deactivated.

All shapes attached to this plant will also be deactivated.

12.6.7 Reactivate a plant

- ➔ To reactivate a plant: select the plant in the plants' list and click on "Desactivate/Reactivate".

When the plant data appears on the fuels' editor screen, click on "Reactivate in the database".

Shapes attached to this plant won't be reactivated.

12.7 FuelEditors (allometric approach for trees)

Allometric models can be used to fill up the 3D Matrix of the crown of some species. These models are generally based on a dendrometric property of the tree, such as diameter at breast height (DBH, generally in cm) or tree height (H, in m). The requirements are the following:

- a model for the crown envelope
- a model for fuel mass in the envelope
- additional properties such as moisture content (MC, %), fuel density (MVR, kg m⁻³) and area to volume ratio (SVR, m⁻¹) to compute fuel volume, fuel surface and water mass in each voxel.

12.7.1 Crown envelope

The crown envelope modeling is based on tree dimension models for height, crown based height, crown radius and on crown shape models. Examples of tree dimension models are provided in Table 6.

Table 6: Allometric relationships for tree dimensions

	Tree Height (m)	Crown Radius (m)	Crown Base Height
<i>Picea mariana</i>	$0.9477 DBH + 0.7108$ (Derived from [24])	if $H < 1.3$, $0.3125 H$, else $0.1364 H$ (Derived from [24])	$0.6 H$ (From [24])
<i>Pinus banksiana</i>	$\min \left(\begin{matrix} 3.2678 DBH^{0.5703} \\ 2.24 DBH - 1.1925 \end{matrix} \right)$ (Derived from [24])	$0.0661 H$ (Derived from [24])	$0.25 H$
<i>Pinus halepensis</i>	$2.55 DBH^{0.45}$ [25]	$0.1461 DBH^{0.8805}$ [25]	
<i>Pinus pinaster</i>		$0.106 DBH^{0.861}$ [28]	
<i>Pinus sylvestris</i>			$H - (1.94 + 0.105 H - 0.016 H^2 - 0.34 H/DBH + 0.048(H - \text{dom}H) - 0.009 BA)^2$ (*) [27]
<i>Quercus pubescens</i>	$10.5 (1.0 - e^{-0.125 DBH}) - 1.3$ (Cermak et al 2008 or [29])	$0.4 + 0.0067 DBH^{1.82}$ [29]	

(*) domH is the dominant height in stand, BA is the basal area in stand

Crown shape models are generally a function of height, crown base height, crown radius and relative height in crown. For example, with the relative height in crown (L_{rel}) and the relative radius in crown (R_{rel}) Porté et al. (2000) [28] provide the following relationship for maritime pine:

$$R_{rel} = 8.30 L_{rel} - 23.4 L_{rel}^2 + 27.0 L_{rel}^3 - 11.9 L_{rel}^4$$

In Ponderosa pine, Linn et al. (2005) [30] used the following equations:

If L is the crown length and L_{low} (taken equal to $0.2L$) the length of the lower part of the crown:

$$\text{if } z < H, R_{rel} = \sqrt{\frac{z}{L_{low}}}, \text{ else, } R_{rel} = \sqrt{\frac{L - z}{L - L_{low}}}$$

12.7.2 Thin biomass

Fuel biomass in the envelope is generally assessed by the combination of allometric relationship to determine total thin biomass in a given plant (Table 7) and thin biomass distribution in crown.

Table 7: Allometric relationships for thin biomass

Species	Leaves [Reference]	Twigs [Reference]
<i>Picea mariana</i>	$0.233 DBH^{1.254}$ [24]	$0.133 DBH^{1.115}$ (live) $0.0555 DBH^{1.123}$ (dead) [24]
<i>Pinus banksiana</i>	$0.00672 DBH^{2.257}$ [24]	$0.00478 DBH^{2.0889}$ (live) $0.00827 DBH^{1.889}$ (dead) [24]
<i>Pinus halepensis</i>	$0.026 DBH^{1.93}$ [25] $0.0231 DBH^{1.81}$ [26]	
<i>Pinus pinaster</i>	$0.071 \frac{DBH^{2.508}}{Age^{1.18}} +$ $0.034 \frac{DBH^{2.708}}{Age^{1.16}} +$ $1.20 \frac{DBH^{2.308}}{Age^{2.31}}$ [28]	
<i>Pinus ponderosa</i>	$0.52 CR^2 L$ (derived from integration of [30])	
<i>Pinus sylvestris</i>	$0.108 DBH^{1.51}$ (Montes 2007)	
<i>Quercus ilex</i>	$0.158 e^{0.2243 DBH}$ (Porte unpublished) but dbh<!!	
<i>Quercus pubescens</i>	$(0.505 DBH^{1.53} - 1) / SLA (*)$ [29]	

(*) SLA is the specific leaf area of the leaves (m²/kg)

The biomass distribution in crown is generally a function of the relative height and relative radius. The most common approach for biomass distribution is assessment of a cumulative vertical distribution of biomass following:

$$Distribution(H_{rel}) = \frac{a}{1 + e^{b-c H_{rel}}}$$

This approach has been used by several authors (Table 8).

Table 8: Parameters of the inside-crown distribution of thin biomass, for different species

$$(Distribution(H_{rel}) = \frac{a}{1 + e^{b-c H_{rel}}})$$

Species	[Reference]	a	b	c
<i>Picea mariana</i> (leaves)	[24]	1.015	2.775	6.923
<i>Picea mariana</i> (live twigs)	[24]	1.032	2.654	6.113
<i>Picea mariana</i> (dead twigs)	[24]	1.000	9.790	12.25
<i>Pinus banksiana</i> (leaves)	[24]	0.996	2.403	13.09
<i>Pinus banksiana</i> (live twigs)	[24]	0.996	2.936	14.11
<i>Pinus banksiana</i> (dead twigs)	[24]	1.025	3.840	6.945
<i>Pinus halepensis</i> (leaves)	[26]	1.045	4.925	8.055
<i>Pinus halepensis</i> (twigs)	[26]	1.059	4.742	7.131

Other cumulative distributions can be used. Chapman Richards models for *Pinus sylvestris* [27]:

$$M(cumulative) = 0.0428 + 1.14 \left(1 - e^{-3.43 L_{rel}}\right)^{4.99} 0.993$$

For Loblolly pine, Xu and Harrington (1998)[31] used:

$$cumulativeDistribBM = 1 - e^{-(L_{rel}/\beta)^\alpha} \quad \text{with} \quad \alpha = \exp\left(-0.620 \frac{H}{H_{dom}}\right) \exp(0.294 LAI) \quad \text{and}$$

$$\beta = \exp\left(-0.620 \frac{H}{H_{dom}}\right)$$

Other authors use non cumulative distribution. For example, for *Pinus pinaster*, Porté et al. (2000) [28] used:

$$NeedleDensity = c1L_{rel}^{c2}(c3 - L_{rel})^{c4}$$

They used also the same distribution for horizontal distribution, as a function of relative radius in crown. Tognetti et al. (2003) [29] used the following distribution in *Quercus pubescens*:

$$ae^{-b(c-z)^2} + de^{-e(f-z)^2} - g$$

The last approach is the use of direct model for local biomass, as a function of position in crown (*Pinus ponderosa*, [30]):

$$\rho = \frac{L_{rel} + dR_{rel}^2}{L} \rho_{max}$$

12.8 Fuel Editor (Fuel Layers)

The **Fuel layer** is a collection of individual plants, closely grouped and difficult to describe separately, forming a layer generally much more wide than high. A fuel layer is described as a single vegetation object and has almost the same properties than an individual plant. *Quercus coccifera* shrubland is a typical fuel layer. It may be either a measured fuel layer corresponding to a real fuel layer measured in the field, or a virtual fuel layer, created with the *FIRE PARADOX FUEL MANAGER*. A virtual fuel layer may differ from a real one either by its shape, by the distribution of voxels (fuel samples) within its shape, by the values of one or several fuel parameters (*e.g.* mean of several samples).

Let's remind that, as described in part 6.2.1, a **Fuel LayerSet** is a polygon which contains different fuel layers, which represent each fuel type included in the Fuel LayerSet. For example, a Fuel LayerSet of garrigue, can contain 3 layers: *Quercus coccifera*, *Rosmarinus officinalis* and *Brachypodium retosum*.. Fuel layers correspond to a fuel complex where few information is available on the position of the individual fuel type inside of it or when the user wants to summarize them in a unique object. It is generally used to represent understorey, but can be also used to represent canopies. Some **predefined models of Fuel LayerSets** have also been defined, to help the user that does not have the details of the fuel complex descriptions.

This chapter will only deal with **Fuel layer** edition. See chapter 6.2.1 for Fuel Layerset use.

In the 2D data processing, a **Fuel layer** crown shape is split up in "edge", "centre" and "symmetric" elements. Three kinds of shapes can be deduced from the different combinations:

- Edge + symmetric
- Centre
- Edge + centre + symmetric

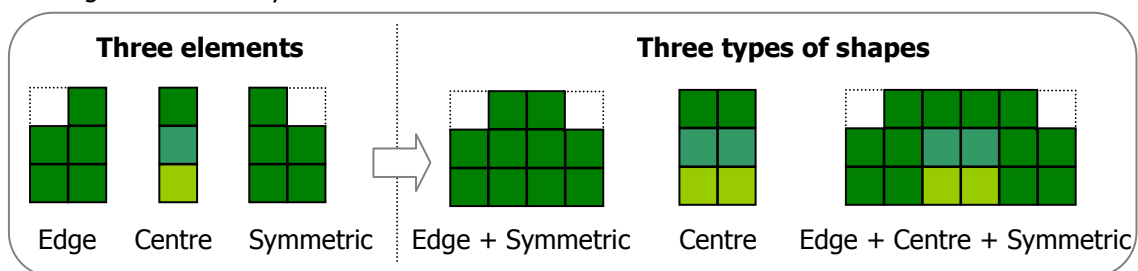

Figure 88: Elements of a crown layer shape and types of shape.

12.8.1 Fuel Layers' List

When selecting the "Layer shrubs" button on the Fuel database manager (Figure 89a), the Layers fuel list window is opened (Figure 89b).

All layers stored in the database appear in a list. This list contains:

- species name
- plant height in meters
- plant crown base height in meters
- plant crown diameter in meters
- plant origin (measured or virtual)
- mention if the plant is validated or not
- mention if the plant is deleted or not.

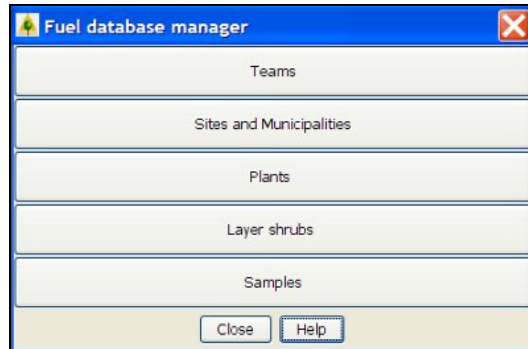

Figure 89a: Fuel database manager window

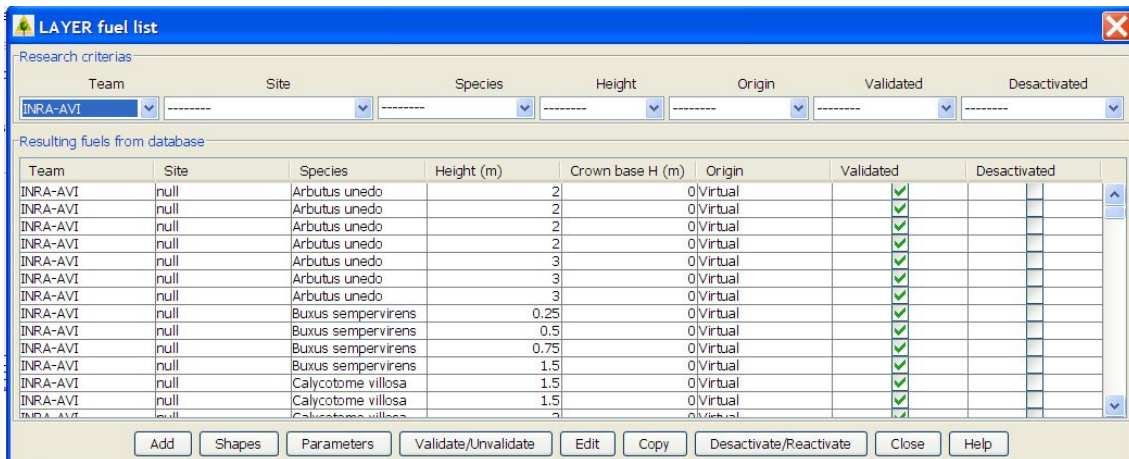

Figure 89b: Fuel layers' list

The list can be restricted with selection in the research criteria's.

Control buttons are:

- "Add": to add a new layer.
- "Shapes": to manage different shapes attached to a layer.
- "Parameters": to enter parameters for each layer particle.
- "Validate": to check a layer data integrity in the database and to permit utilisation in virtual scene creation and in exportation for models as FIRETEC. To be validated a layer must have a 2D shape. A validated layer cannot be modified.
- "Edit": to display plant information. Modification only will be possible if the user is the owner of the fuel and if this layer is not desactivated nor validated. In the contrary, the layer will have to be unvalidated or reactivated before being updated again.

- "Copy": to copy an existing layer in a new one.
- "Desactivate/Reactivate": to denied utilisation of a layer without deleting referenced data. Desactivation is also done for all shapes attached to the fuel. Reactivate action is useful to cancel a desactivation. Only the layer will be reactivated, but not the shapes
- "Close": to close the window.
- "Help": to get help about this screen.

12.8.2 Create or Update a Fuel Layer

- ➔ To create a new fuel layer, click on "Add"
- ➔ To modify a layer, select the layer in the list and click on "Edit".

For further information, refer to plant creation and update (see chapter 12.6.2)

12.8.3 Create shapes for a layer

To be used in the *FIRE PARADOX FUEL MANAGER*, the layer (measured or virtual) has to be described as a 2D shape. Only the cube method is available for creating a layer:

- Enter the voxels and samples dimensions in cm
- Enter the shape dimensions
- "Enter the shape" to continue
- "Close" to cancel the shape creation

The screenshot shows a dialog box titled "New shape design for a measured layer". It contains the following fields and options:

- Samples column dimension (cm):**
 - Voxel height in Z: 25
 - Diameter in X: 25
 - Diameter in Y: 25
 - CORE sample height in Z: 100
 - EDGE sample height in Z: 100
- CORE and EDGE shapes dimension (cm):**
 - CORE height in Z: 100
 - Diameter in X: 25
 - EDGE height in Z: 100
 - Diameter in X: 200
- Layer dimension (cm):**
 - Layer width min: 25
 - Layer spread width max: 200
 - Layer spread MAX: 200

Buttons at the bottom: "Enter the shape", "Close", "Help".

NOTE: For virtual layers, the dialog box and shape creation procedure will be the same

Figure 90: Measured layer shape creation

12.8.3.1 Sample creation for a layer

For a layer, at least one sample creation (CORE or/and EDGE) is compulsory. This sample is composed of a column of voxels, with 3 types represented (TOP/CENTER/BASE).

The procedure is the same as for plant samples (see chapter to 12.6.3.1).

12.8.3.2 2D shape creation for a layer

A layer crown shape is split up in "Core" and "Edge" parts. Each part is optional. If a core sample exists, this sample will be used by default to create the core part. If an edge sample exists, this sample will be used by default to create the edge part. If only one sample exist, this sample will be used to create the both parts.

The layer 2D edition screen is divided into 3 parts:

- Left part for CORE shape modification in 2D
- Central part for EDGE shape modification in 2D
- Right part for legend and biomasses checking

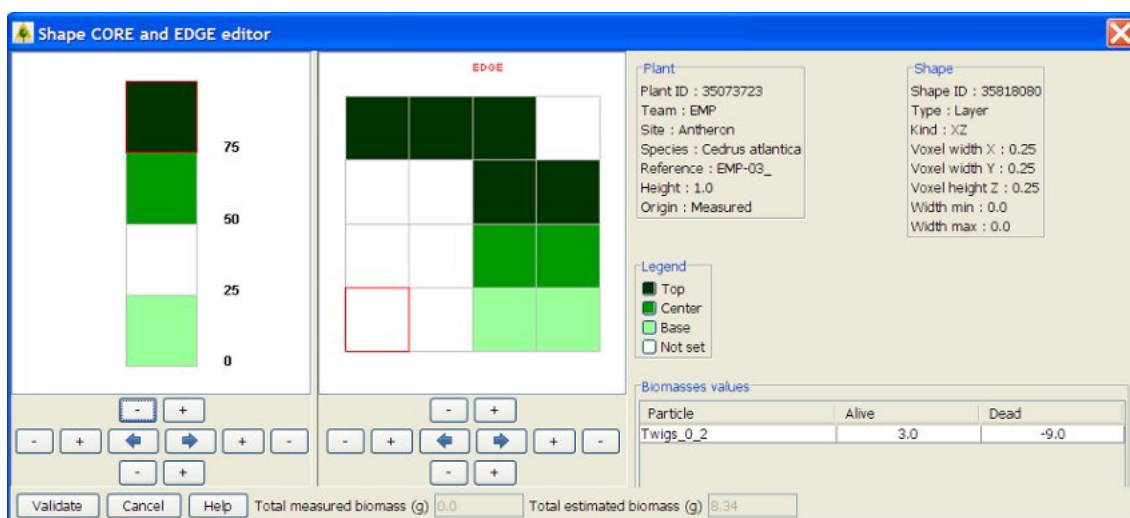

Figure 91: 2D layer shape edition

Left and center part:

- To change a voxel color (type), select the color from the legend and left click on the voxel. The voxel appears in the selected color with a red border.
- Existing particles and biomasses for this type of voxel appear in the bottom right part of the screen.
- To change several voxels color at the same time, draw a rectangle with the right click around the group of voxels.
- A zoom tool is available by drawing a rectangle with the left click of the mouse. A single right click enables to zoom forward.



Decrease and increase the grid size in 4 dimensions.

Copy voxels from left to right symmetrically to Z axe.

Right part:

- Select the type of voxel to spread on the shape in the coloured square in the legend (TOP/CENTER/BOTTOM). The selected type name appears in RED.
- A white voxels represent empty areas in the crown.
- At the bottom right part of the screen, particles list with biomasses for the selected type of voxel is displayed. Biomasses values CAN NOT be modified here. Unit is grams.

Control:

- At the bottom of the screen, the total estimated biomass is automatically calculated.
- Total measured biomass from the sampling, is displayed for control.
- Click on "Validate" to save the shape in the database.
- All empty voxel rows at the right or at the top of the shape will NOT be saved. The shape size will be automatically adjusted.

NOTE: It is NOT POSSIBLE to modify biomasses values or to add a new particle from this interface, you have to go back to the SAMPLES edition in the same layer.

12.8.4 Create or Update layer Particles Parameters

This procedure is the same as for plant particle parameters (see chapter 12.6.5).

12.8.5 Deactivate a layer

- ➔ To deactivate a layer: select the layer in the layer list and click on "Desactivate/Reactivate" button.

When the fuel data appears on the fuels' editor screen, click on "Desactivate in the database".

The vegetation object won't be physically deleted in the database, it will be logically deactivated.

All shapes attached to the deactivated layer will also be deactivated.

12.8.6 Reactivate a layer

- ➔ To reactivate a layer: select the layer in the layer list and click on "Desactivate/Reactivate".

When the fuel data appears on the fuels' editor screen, click on "Reactivate in the database".

Shapes attached to this layer won't be reactivated.

12.9 Fuel Editor (Fuel samples)

Fuel samples are the third category of fuel that can be manipulated by the *FUEL MANAGER* through the **Fuel Editor**. Fuel samples are sample of fuel of a lower level than a vegetation object (individual plant). Fuel sampling is generally carried out with the so called "cube" method, collecting fuel in elementary volumes of 25 cm side. Consequently a typical fuel sample is a 25 cm x 25 cm x 25 cm voxel, although it may have other dimensions. A fuel sample may be collected by field destructive measurements (measured), or calculated. Fuel sample is generally created during plant creation process. The following functionalities are only dedicated to fuel sample editing and modification.

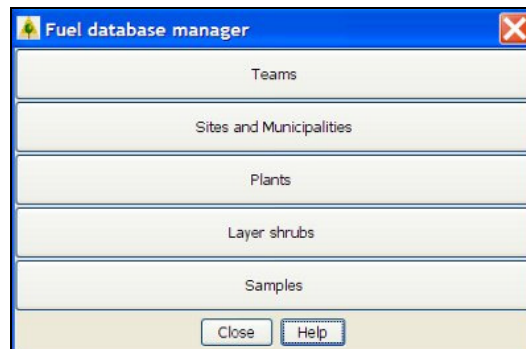

Figure 92: Fuel database manager

13 REFERENCES

- [1]. Morsdorf F. and Allgöwer B. (Eds.) 2007. Review of fuel description methods. Deliverable D.3.4-2 of the Integrated project "Fire Paradox", Project no. FP6-018505, European Commission, 55 p.
- [2]. de Coligny F., Ancelin P., Cornu G., Courbaud B., Dreyfus P., Goreaud F., Gourlet-Fleury S., Meredieu C., Orazio C., Saint-André L. 2004. CAPSIS: Computer-Aided Projection for Strategies In Silviculture: Open architecture for a shared forest-modelling platform. I: Nepveu G. (Ed.): Connection between Forest Resources and Wood Quality: Modelling Approaches and Simulation Software. Nancy, France: LERFoB INRA-ENGREF, pp. 371-380. Fourth workshop, IUFRO Working Party S5.01.04, 8-15/09/2002, Harrison Hot Springs Resort, British Columbia, Canada.
- [3]. de Coligny F. 2008. Efficient Building of Forestry Modelling Software with the Capsis Methodology. In: Fourcaud T, Zhang XP, eds. Plant Growth Modeling and Applications. Proceedings of PMA06. Los Alamitos, California: IEEE Computer Society, pp. 216-222.
- [4]. <http://java.sun.com/>
Java Sun official website.
- [5]. Peterson DL., Ryan KC. 1986. Modeling post-fire conifer mortality for long-range planning. *Environmental Management* 10, 797-808.
- [6]. Bova AS, Dickinson MB. 2005. Linking surface-fire behavior, stem heating, and tissue necrosis. *Canadian Journal of Forest Research* 35, 814-822.
- [7]. Jones JL., Webb BW., Jimenez D., Reardon J., Butler B. 2004. Development of an Advanced one-dimensional stem heating model for application in surface fires. *Canadian Journal of Forest Research* 34, 20-30.
- [8]. Ryan KC., Rigolot R., Botelho H. 1994. Comparative analysis of fire resistance and survival of Mediterranean and western North American conifers. Society of American Foresters, Book of Proceedings of the 12th Conference on Fire and Forest Meteorology, p701-708.
- [9]. Pimont F., Prodon R., Rigolot E. 2006. Comparison of post fire mortality of *Pinus nigra subsp. laricio* and *Pinus pinaster*. Submitted to Annals of forest science.
- [10]. IFN 1990. Inventaire Forestier National. Département des Alpes-de-Haute-Provence.
- [11]. IFN 1990. Inventaire Forestier National. Département des Alpes-Maritimes.
- [12]. Van Wagner CE. 1977. Conditions for the start and spread of crown fire. *Canadian Journal of Forest Research* 7, 23-24.
- [13]. Saveland JM., Neuenschwander LF. 1989. Predicting ponderosa pine mortality from understory prescribed burning. Symposium Proceedings of "Prescribed Fire in the intermountain region".
- [14]. Finney MA., Martin RE. 1992. Modeling effects of prescribed fire on young-growth coast redwood trees. *Canadian Journal of Forest Research* 23 (6), 1125-1135.
- [15]. Michaletz ST., Johnson EA. 2006a. A heat transfer model of crown scorch in forest fires. *Canadian Journal of Forest Research* 36, 2839-2851.
- [16]. Michaletz ST., Johnson EA. 2008. A biophysical process model of tree mortality in surface fires. *Canadian Journal of Forest Research* 38, 2013-2029.
- [17]. Rigolot E. 2004. Predicting postfire mortality of *Pinus halepensis* Mill. and *Pinus pinea* L. *Plant Ecology* 171: 139-151.

- [18]. Botelho, H.S., Rego, F.C., Ryan, K.C., 1998a. Tree mortality models for *Pinus pinaster* of Northern Portugal. *In: Proceedings of the 13th Conference on Fire and Forest Meteorology. International Association of Wildland Fire*, pp. 235–240
- [19]. Sidoroff K., Kuuluvainen T., Tanskanen H., Vanha-Majamaa I. 2007. Tree mortality after low-intensity prescribed fires in managed *Pinus sylvestris* stands in southern Finland. *Scand. J. For. Res.* 22, 2–12.
- [20]. Ryan K.C. and Amman G.D. 1994. Interactions between fire-injured trees and insects in the greater Yellowstone area. *Plants and their Environments*. In: US Department of Interior and National Park Service (ed.), *Book of Proceedings of the First Biennial Scientific Conference on the Greater Yellowstone Ecosystem 1991*. WY: 259-271.
- [21]. Catry FX, Moreira F, Duarte I, Acacio V. 2009. Factors affecting post-fire crown regeneration in cork oak (*Quercus suber* L.) trees. *European Journal of Forest Research* 128, 231-240.
- [22]. Ryan KC. 1982. Evaluating potential tree mortality from prescribed burning. Baumgartner DM. (ed.), p167-179.
- [23]. Linn RR (1997) 'Transport model for Prediction of Wildfire Behaviour'. Los Alamos National Laboratory, Scientific Report LA13334
- [24]. Alexander, M.E.; Stefner, C.N.; Mason, J.A.; Stocks, B.J.; Hartley, G.R.; Maffey, M.E.; Wotton, B.M.; Taylor, S.W.; Lavoie, N.; Dalrymple, G.N. 2004. Characterizing the jack pine-black spruce fuel complex of the International Crown Fire Modelling Experiment (ICFME). Canadian Forest Service, Northern Forestry Centre, Edmonton, Alberta. Information Report NOR-X-393. 49 pp.
- [25]. Lopez-Serrano FR., de las Heras J., Gonzalez-Ochoa AG., Garcia-Morote AI. 2005. Effects of silvicultural treatments and seasonal patterns on foliar nutrients in young post-fire *Pinus halepensis* forest stands. *Forest Ecology and Management*. 210:321-336.
- [26]. Mitsopoulos ID, Dimitrakopoulos AP. 2007b. Allometric equations for crown fuel biomass of Aleppo pine (*Pinus halepensis* Mill.) in Greece. *International Journal of Wildland Fire* 16, 642-747.
- [27]. Tahvainainen T, Forss E. 2008. Individual tree models for the crown biomass distribution of Scots pine, Norway spruce and birch in Finland. *Forest Ecology and Management* 255, 455-467.
- [28]. Porté A, Bosc A, Champion I, Loustau D. 2000. Estimating the foliage of Maritime pine (*Pinus pinaster* Ait.) branches and crowns with application to modelling the foliage area distribution in the crown. *Annals of Forest Sciences* 67, 73-86.
- [29]. Tognetti R., Cherubini P., Marchi S., Raschi A., 2003. Leaf traits and tree rings suggest different water-use and carbon assimilation strategies by two co-occurring *Quercus* species in a Mediterranean mixed-forest stand in Tuscany, Italy. *Tree Physiology* 27:1741-1751.
- [30]. Linn, R.R., Winterkamp, J., Colman, J.J., Edminster, C., Bailey, J., 2005. Modeling interactions between fire and atmosphere in discrete element fuel beds. *International Journal of Wildland Fire*. 14, 37-48.
- [31]. Xu M., Harrington TB. 1998. Foliage biomass distribution of loblolly pine as affected by tree dominance, crown size and stand characteristics.

14 ANNEX

14.1 Annex – Inventory Files

Inventory file "Lamanon_Mixed_WP61_sg.scene.scene"

```
#Scene file of the mixed plot at the Lamanon experimental study site
#Terrain
#name  cellWidth(m)  altitude(m)  xMin  yMin  xMax  yMax
Terrain0      5      0      -60   -60   60    60

#Polygons (optionnal)
#fileId {(x1,y1);(x2,y2)...}
1      {(-55,-55);(-55,-42);(-30,-40);(-35,-57)}

#Trees
#fileId speciesName      x      y      z      height  crownBaseHeight
      crownDiameter  crownDiameterHeight  openness
1      Pinus halepensis      -4.55  2.55  0      13.5   7.1   4.78  10      true
2      Pinus halepensis      -10.5  -3.6  0      15     7.3   8.15  10      true
3      Pinus halepensis      -2.5   -4.6  0      14.2   9     8.35  10      true
4      Pinus halepensis      14.85  -14.85 0      5.8    4.6   1.28  5       true
5      Pinus halepensis      14.8   -13.35 0      8.1    5.15  1.68  7       true
6      Quercus ilex            6.75   -14.1  0      11.75  5.35  4     10      true
7      Pinus halepensis      4.85   -12.8  0      9.3    5.45  1.73  7       true
8      Pinus halepensis      2.8    -12.95 0      7.25   6.2   1.07  7       true
9      Pinus halepensis      3.25   -11.6  0      10.5   6.15  2.18  7       true
10     Pinus halepensis      0.95   -12.7  0      12.9   8.45  2.38  10      true
11     Pinus halepensis      -1.25  -11.45 0      12.2   7.4   3.35  10      true
12     Pinus halepensis      1      -14.4  0      12.7   7.25  4.63  10      true
13     Quercus ilex            -0.05  -12.2  0      8.2    6.6   1.1   7       true
14     Pinus halepensis      -3.2   -10.45 0      8.45   6.05  1.6   7       true
15     Pinus halepensis      -9.75  -13.8  0      14.15  6.55  5.8   7       true
16     Pinus halepensis      0.85   -3.85  0      11     6.5   2.5   10      true
17     Pinus halepensis      2.9    -3.4   0      11.3   6.1   4.4   10      true
18     Pinus halepensis      1.05   -1.45  0      8.5    4.5   2.18  7       true
19     Pinus halepensis      -1.7   3.2    0      9.6    4.7   2.9   7       true
20     Pinus halepensis      -1.45  -2.75  0      8.6    6.7   1.65  8       true
21     Pinus halepensis      -7.4   14.5   0      8.3    4.9   1.5   7       true
22     Pinus halepensis      -3.2   12.1   0      5.7    3.8   1.38  5       true
23     Pinus halepensis      1.35   12.2   0      10.8   5.6   6.5   10      true
24     Quercus ilex            4.35   14.4   0      11.3   5.7   3.68  10      false
25     Pinus halepensis      14.85  12.9   0      10.7   5.1   5.15  10      false
26     Pinus halepensis      12     8.3    0      11.8   5.9   7.8   10      false
27     Pinus halepensis      12.35  7.7    0      6     4     1.7   5       false
28     Pinus halepensis      10     8     0      5.4    4.3   2.1   5       false
29     Pinus halepensis      11.95  6.15  0      11.7   6.2   2.43  10      false
30     Pinus halepensis      13.8   5.8    0      6.5    5     0.5   5       false
31     Quercus ilex            14.05  4.35  0      11.7   5     6.35  10      false
32     Pinus halepensis      14.15  0.15  0      10     4.5   5.05  7       false
```

33	Pinus halepensis	10.95	0.15	0	7.9	4.3	1.75	7	false
34	Pinus halepensis	9.75	2.25	0	11	5.5	3.45	7	false
35	Quercus ilex	7.55	2.8	0	9.5	5.2	2.7	7	false
36	Pinus halepensis	8.75	5.3	0	12.2	10.3	3.9	11	false
37	Pinus halepensis	-3.05	-8.45	0	10.05	6.7	2.08	7	false
38	Quercus ilex	-5.6	-7.1	0	9.8	6.55	2.18	7	false
39	Pinus halepensis	-4.1	-11.2	0	10.75	5.8	3.23	7	false
40	Pinus halepensis	15.3	6.1	0	10.23	7	2.83	9	false
41	Pinus halepensis	-18.15	12.4	0	14.75	6.5	9.7	9	false
42	Pinus halepensis	-2.9	15.8	0	11.75	4.75	6.85	9	false
43	Quercus ilex	-1.15	-15.15	0	13	5.7	5.53	9	false
44	Pinus halepensis	4.4	-16	0	11.55	5.95	4.73	9	false
45	Pinus halepensis	8.5	-17.1	0	10	4.4	3.95	9	false
46	Pinus halepensis	16.15	5	0	7.5	3.5	2.08	7	false
47	Pinus halepensis	15.85	-5.15	0	10.4	3.5	2.55	9	false
48	Pinus halepensis	16.25	-10.5	0	11	3.7	5.43	9	false

Inventory file "_4REC_pop1Pins bonnes valeurs.txt"

#Scene file of the mixed plot at the Lamanon experimental study site

#Terrain

#name	cellWidth(m)	altitude(m)	xMin	yMin	xMax	yMax
Terrain0	5	0	-50	-50	50	50

#Polygons (optionnal)

#fileId {(x1,y1);(x2,y2)...}

1 {(-55,-55);(-55,-42);(-30,-40);(-35,-57)}

#Pops

Gibbs : 0=aléatoire, 1000 -> régulier, <0 -> agrégé

#npop	Gibbs	radius	distPopi_A	distPopi_B	distPopi_C	distWeight_A	distWeight_B	distWeight_C
1	0	0	2	-5	-5	-5	-5	-5
2	0	0	-5	-5	2	5	-5	-5
3	0	0	-5	-5	-5	-5	-5	9
4	0	0	-5	-5	-5	-5	-5	-5

#Trees

#pop	species	height	crownBH	crownD	cover_pct
1	Pinus halepensis	13.5	7	12	15
2	Quercus ilex	6.5	2	5	15
3	Quercus pubescens	6.5	1	5	15
4	Buxus sempervirens	1.5	0	4.5	30

Inventory file "fuelbreak.txt"

```
#Scene file of a fuelbreak for the fuelmanager paper

#Terrain
#name  cellWidth(m)  altitude(m)  xMin  yMin  xMax  yMax
Terrain0      10      0      0      0      300  200

#Polygons (optionnal)
#fileId "{(x1,y1);(x2,y2)...}"
1      {(0,0);(120,0);(120,200);(0,200)}
2      {(120,0);(166,0);(166,200);(120,200)}
3      {(174,0);(220,0);(220,200);(174,200)}
4      {(220,0);(300,0);(300,200);(220,200)}

#TreeGroups

#fileId speciesName  polygonId  lowerBoundDBH  upperBoundDBH  groupAge
stemDensity  MCNeedles  MCLiveTwigs  MCDeadTwigs
1      Pinus halepensis  1      10      30      40.0  400      100      80      10
2      Pinus halepensis  2      20      30      40.0  50      100      80      10
3      Pinus halepensis  3      20      30      40.0  50      100      80      10
4      Pinus halepensis  4      10      30      40.0  400      100      80      10

#LayerSet

#fileId polygonId speciesName height  bottomHeight  percentage  spatialGroup
characteristicSize  aliveMoistureContent  aliveBulkDensity  deadBulkDensity  mvr  svr
1      1      Quercus coccifera  0.75  0.0  70.0  2.0  0  70.0  10.0
1.0  0.1  500.0  5000.0
2      1      Brachypodium ramosum  0.25  0.0  20.0  0.5  1  10.0  0.0
0.4  0.0  500.0  10000.0
3      2      Quercus coccifera  0.25  0.0  25.0  2.0  0  70.0  10.0
1.0  0.1  500.0  5000.0
4      2      Brachypodium ramosum  0.25  0.0  25.0  0.5  1  10.0  0.0
0.4  0.0  500.0  10000.0
5      3      Quercus coccifera  0.25  0.0  25.0  2.0  0  70.0  10.0
1.0  0.1  500.0  5000.0
6      3      Brachypodium ramosum  0.25  0.0  25.0  0.5  1  10.0  0.0
0.4  0.0  500.0  10000.0
7      4      Quercus coccifera  0.75  0.0  70.0  2.0  0  70.0  10.0
1.0  0.1  500.0  5000.0
8      4      Brachypodium ramosum  0.25  0.0  20.0  0.5  1  10.0  0.0
0.4  0.0  500.0  10000.0

#Trees

#fileId speciesName  x      y      z      height  crownBaseHeight  crownDiameter
crownDiameterHeight  openness
```

14.2 Annex – Chain between Patterns' Editor GUIs

