



HAL
open science

Rhizosphere models

Norbert Claassen, Peter de Willigen, Marius Heinen, Alain Mollier, Claude Doussan, Vanessa M. Dunbabin, J. W. Hopmans, G. Kirk, Yakov Kuzyakov, Heino Nietfeld, et al.

► **To cite this version:**

Norbert Claassen, Peter de Willigen, Marius Heinen, Alain Mollier, Claude Doussan, et al.. Rhizosphere models. Handbook of Methods Used in Rhizosphere Research, Swiss Federal Institute for Forest, Snow and Landscape Research WSL, 536 p., 2006, 3-905621-35-5. hal-02823444

HAL Id: hal-02823444

<https://hal.inrae.fr/hal-02823444>

Submitted on 6 Jun 2020

HAL is a multi-disciplinary open access archive for the deposit and dissemination of scientific research documents, whether they are published or not. The documents may come from teaching and research institutions in France or abroad, or from public or private research centers.

L'archive ouverte pluridisciplinaire **HAL**, est destinée au dépôt et à la diffusion de documents scientifiques de niveau recherche, publiés ou non, émanant des établissements d'enseignement et de recherche français ou étrangers, des laboratoires publics ou privés.

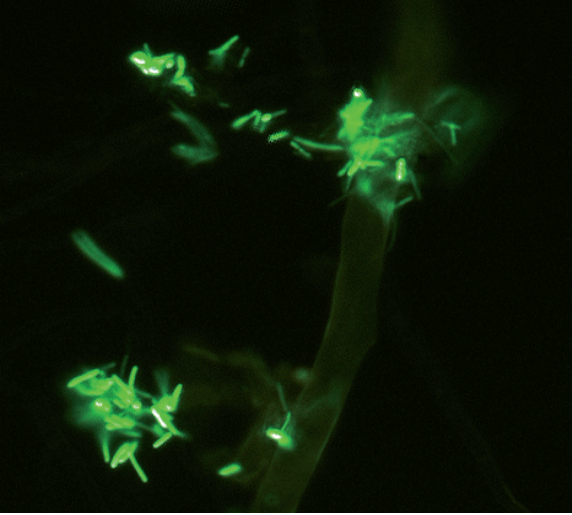

 **COST 631**

Handbook of Methods Used in Rhizosphere Research

Jörg Luster, Roger Finlay (Editors)

Brunner, I.; Fitz, W.J.; Frey, B.; Göttlein, A.;
Helmisaari, H.-S.; Jaillard, B.; Jones, D.L.;
Martin-Laurent, F.; Neumann, G.; Nietfeld, G.;
Nowack, B.; Puschenreiter, M.; Robin, C.;
Schweiger, P.; Senesi, N.; Turnau, K.;
Wenzel, W.W. (Chapter Editors)



COST is supported
by the EU RTD
Framework Programme

ESF provides the
COST Office
through an EC contract



Swiss Federal Research Institute WSL

 **cost 631**

Handbook of Methods Used in Rhizosphere Research

Jörg Luster, Roger Finlay (Editors)

Brunner, I.; Fitz, W.J.; Frey, B.; Göttlein, A.;
Helmisaari, H.-S.; Jaillard, B.; Jones, D.L.;
Martin-Laurent, F.; Neumann, G.; Nietfeld, G.;
Nowack, B.; Puschenreiter, M.; Robin, C.;
Schweiger, P.; Senesi, N.; Turnau, K.;
Wenzel, W.W. (Chapter Editors)

This publication was supported by COST:

COST is an intergovernmental European framework for international cooperation between nationally funded research activities. COST creates scientific networks and enables scientists to collaborate in a wide spectrum of activities in research and technology. COST activities are administered by the COST Office.

The editors:

Luster, Jörg

Swiss Federal Institute for Forest, Snow and Landscape Research WSL
Zürcherstrasse 111, CH-8903 Birmensdorf, Switzerland
joerg.luster@wsl.ch; ++41 44 739 22 95

Finlay, Roger D.

Dept. Forest Mycology & Pathology, SLU
Box 7026, SE-750 07 Uppsala, Sweden
roger.finlay@mykopat.slu.se; ++46 18 67 15 54

Recommended form of citation:

Book:

Luster, J., Finlay, R. (eds) 2006: Handbook of Methods Used in Rhizosphere Research. Birmensdorf, Swiss Federal Research Institute WSL. 536 pp.

Summaries:

Name(s) Chapter Editor(s) 2006: Summary Chapter Title. In: Luster, J., Finlay, R. (eds) Handbook of Methods Used in Rhizosphere Research. Birmensdorf, Swiss Federal Research Institute WSL. XXX–XYZ.

Method Sheets:

Name(s) Author(s) 2006: "Method" OR "Parameter" by "Method" entry from sheet. In: Luster, J., Finlay, R. (eds) Handbook of Methods Used in Rhizosphere Research. Birmensdorf, Swiss Federal Research Institute WSL. XXX–XYZ.

Available from:

Library WSL
Zürcherstrasse 111
CH-8903 Birmensdorf
Fax ++41 44 739 22 15
e-mail: publications@wsl.ch

EUR 40.–/CHF 60.–

ISBN 3-905621-35-5

© Swiss Federal Research Institute WSL, Birmensdorf, 2006

Cover from top to bottom:

Gfp-tagged soil bacteria growing together with hyphae of the arbuscular mycorrhizal fungus *Glomus intraradices*

(picture by Jonas Toljander and Veronica Artursson, Uppsala)

Rhizobox to study chemical gradients in the rhizosphere

(picture by Walter Fitz, Vienna)

Visualisation of root-induced Al-complexation in seedlings of *Lupinus luteus*

(picture by Günter Neumann, Stuttgart-Hohenheim)

Preface

Investigating the rhizosphere where plant roots, microbes and soil interact intensively, is inherently interdisciplinary involving soil chemistry and physics, plant physiology and soil micro- and molecular biology. Each of these disciplines operate with their own jargon and their own methods. Therefore, there is a large need for better communication between the disciplines and for cross-disciplinary education with respect to methodology. Furthermore, rhizosphere processes inherently occur on a microscale and influences of roots, microbes and soil chemistry are often difficult to distinguish. Modelling is therefore needed to understand fundamental processes occurring at a microscopic scale and to scale these up to understand their contribution to element fluxes and processes occurring at the macroscopic and ecosystem level. Based on these considerations, one of the deliverables of COST action 631 was to compile a handbook of methods used in rhizosphere research, and make it available to the broader rhizosphere community. Another objective was to build a bridge between researchers who work experimentally and those who focus on modelling. The result of this effort is a collection of standardized method and model descriptions covering important aspects of rhizosphere research:

Chapter 1 deals with the question how to define a rhizosphere. In particular, sub-chapters treat growth systems, root growth and morphology, as well as the sampling of rhizosphere soil and soil solution.

Chapter 2 is devoted to the occurrence and bioavailability of elements and ions in the soil and their uptake into plants. Methods are described for localization and total analysis of elements in plant and fungal tissue, and for the quantification of total elemental and ionic contents as well as elemental speciation in the soil solid phase and in soil solution.

Chapter 3 covers the fluxes and transformations of organic carbon in the rhizosphere. Sub-chapters deal with the collection and identification of root exudates, isotopic and biosensor methods to trace carbon fluxes and turnover in soils, and the characterization of soil organic matter and xenobiotics.

The general theme of chapter 4 is the occurrence, identity and activity of microorganisms in the rhizosphere. In particular, microbial growth and visualisation of bacteria and fungi, enzyme activities, as well as the molecular identification and functional analysis of single species and communities are treated in sub-chapters.

The last chapter, chapter 5, gives an overview of models that have been used or have a potential to be used in rhizosphere research. This includes water and nutrient uptake models, soil chemical speciation and transport models, root architecture models and combinations thereof. In addition, a link is included to a web model data base.

The concept of the handbook is based on two components. Firstly, method sheets are one to two page descriptions of a method or a method adaptation and the practical experience with it by individual researchers or research groups. They include information not normally contained in the literature, such as: in which systems a method has been used successfully so far, in which systems the method has not been used at all, and in which systems the use of the method has proved unsuccessful. In addition, potential pitfalls and a list of do's and don'ts are included as well as links to detailed protocols if available. The method sheets mainly cover the expertise within the COST 631 community. Some gaps, however, were filled with expertise from other research groups. Secondly, summaries of methods for a given group of parameters have been written by experts in the field, who were also responsible for compiling the respective method sheets. They discuss groups of methods in a broader, critical perspective. In particular, they compare advantages and disadvantages of methods against each other and give brief introductions to important groups of methods that are not covered by method sheets.

The handbook offers a unique collection of proven methods covering a wide range of areas of rhizosphere research. We have attempted to include both "tried and tested", traditional methods, as well as newer techniques which are still being developed and refined.

We hope the collection of methods will be useful to early career scientists, as well as established scientists seeking information outside their main areas of subject specialisation. The handbook offers a good starting point for aiding communication in interdisciplinary rhizosphere studies, however we are aware that it cannot replace the detailed information available in many excellent textbooks and web based method collections dealing with the analyses of plant and soil material or the characterization of microorganisms, and it has not been our intention to duplicate these existing sources of information. A selection of basic references is given below. More specialised textbooks or review articles are cited in the respective chapter summaries.

Plant analysis:

Harborne, J.B. 1998. *Phytochemical Methods - a Guide to Modern Techniques of Plant Analysis*. Chapman & Hall, London.

Kalra, Y.P. 1998. *Handbook of Reference Methods for plant analysis*. 1998, CRC Press, Boca Raton.

Smit, A.L.; Bengough, A.G.; Engels, C.; van Noordwijk, M.; Pellerin, S.; van de Geijn, S.C. (eds.). 2000. *Root Methods: A Handbook*. Springer, Berlin.

Soil and soil solution analysis:

Sparks, D.L. (ed.). 1996. *Methods of Soil Analysis; Part 3, Chemical Methods*. Soil Science Society of America Book Series No. 5, Soil Science Society of America, Madison WI.

Standard Methods for the Examination of Water and Wastewater. 17th Edition, 1989, American Public Health Association, Washington, DC.

Microbial analysis:

Alef, K.; Nannipieri, P. 1995. *Methods in Applied Soil Microbiology and Biochemistry*. Academic Press, London.

Kowalchuk, G.A.; de Bruijn, F.J.; Head, I.M.; Akkermans, A.D.L.; van Elsas, J.D. (eds). 2004. *Molecular Microbial Ecology Manual*. Second Edition. Springer

Norris, J.R.; Read, D.; Varma, A.K. 1994. *Techniques for Mycorrhizal Research*. Methods in Microbiology, Academic Press Inc., San Diego, CA.

Varma, A. 1998. *Mycorrhiza manual*. Springer-Verlag, Berlin.

The handbook appears both as a printed volume and a web-based cross-linked collection at www.rhizo.at/handbook.

Jörg Luster
Roger Finlay

Contents

Part I: Summaries

1. Growth, Morphology & Sampling

- 1.1. Growth systems 9
Fitz, W.J.; Puschenreiter, M.; Wenzel, W.W.
- 1.2. Root growth and morphology 16
Helmisaari, H.-S.; Brunner, I.
- 1.3. Sampling of rhizosphere soil and rhizosphere soil solution 25
Göttlein, A.

2. Inorganic Chemistry

- 2.1. Elemental analysis of roots and fungi 30
Frey, B.; Turnau, K.
- 2.2. Elements in soils: total and extractable contents, solid phase speciation 38
Jaillard, B.
- 2.3. (Rhizosphere) soil solution: elemental and ionic composition, speciation 44
Nowack, B.

3. Organic Chemistry

- 3.1. Root exudates and organic composition of plant roots 52
Neumann, G.
- 3.2. Element cycling and organic matter turnover 62
Robin, C.
- 3.3. Soil organic matter and organic pollutants 69
Senesi, N.

4. Microbiology, Biochemistry & Molecular Biology

- 4.1. Microbial growth and visualisation of bacteria and fungi 73
Schweiger, P; Finlay, R.D.
- 4.2. Biochemistry 79
Jones, D.L.
- 4.3. Identification of single species and communities 86
Finlay, R.D.
- 4.4. Gene expression of single species and communities 95
Martin-Laurent, F.

5. Modelling

- 5.1. Rhizosphere models 99
Niefeld, G.

5.2. ModellInfo: database for rhizosphere models	117
Schnepf, A.	

Part II: Method Sheets

All method sheets carry an ID composed of the chapter they are assigned to and the name of the first author, e.g. **12_Futsaether** refers to a method sheet discussed mainly in chapter 1.2. with C. Futsaether as first author. If there are more than one method sheet of the same first author assigned to one chapter, the ID contains as a third component a small letter, e.g. **12_Sainz_a** and **12_Sainz_b**. Referencing to method sheets is done using the ID in bold.

1. Growth, Morphology & Sampling

1.1. Growth Systems	119
---------------------	-----

Contributors: Ariati, L.; Berta, G.; Bucher, M.; Corgié, S.; Cresta, A.; Eich-Greatorex, S.; El-Azab, K.; Fitz, W.J.; Frossard, E.; Futsaether, C.; Gahoonia, T.S.; Göttlein, A.; Hacin, J.; Heim, A.; Hinsinger, P.; Jansa, J.; Jauzein, M.; Joner, E.; Le Bayon, R.C.; Leyval, C.; Lingua, G.; Luster, J.; Neumann, G.; Oxaal, U.; Puschenreiter, M.; Sandnes, A.; Vierheilig, H.; Volante, A.; Vollsnes, A.V.; Wenzel, W.W.

1.2. Root Growth and Morphology	150
---------------------------------	-----

Contributors: Blaschke, H.; Eich-Greatorex, S.; Futsaether, C.; Gahoonia, T.S.; Gregory, P.; Hargreaves, C.; Helmisaari, H.-S.; Himmelbauer, M.L.; Hodge, A.; Iglesias, M.I.; Kushnir, T.; Lamosa, S.; Lehmann, E.; Løes, A.-K.; Löhmus, K.; Mainiero, R.; Makkonen, K.; Matyssek, R.; McNeill, A.; Menon, M.; Nikolova, P.; Ostonen, I.; Oswald, S.; Oxaal, U.; Sainz, M.J.; Segal, E.; Shani, U.; Thorup-Kristensen, K.; Vollsnes, A.

1.3. Sampling of rhizosphere soil and rhizosphere soil solution	179
---	-----

Contributors: Berge, O.; Blaser, P.; Brandelet, G.; Dessureault-Rompré, J.; Eldhuset, T.D.; Fitz, W.J.; Gahoonia, T.S.; Göttlein, A.; Graf Pannatier, E.; Heulin, T.; Klauth, P.; Kuhn, A.J.; Lindenmair, J.; Lundström, U.S.; Luster, J.; Müller, M.; Nielsen, N.E.; Nowack, B.; Rais, D.; Rist, R.; Roeb, M.; Schoelgens, E.; Schulin, R.; Thiele, B.; Turpault, M.-P.; Vetterlein, D.; Wenzel, W.W.; Wessel-Bothe, S.

2. Inorganic Chemistry

2.1. Elemental analysis of roots and fungi	200
--	-----

Contributors: Brunner, I.; Frey, B.; Grafe, M.; Jansa, J.; McNear, D.H.; Przybyowicz, W.; Sainz, M.J.; Sas-Paszt, L.; Sparks, D.L.; Stepien, T.; Tappero, R.; Turnau, K.; Wierzbicka, M.

2.2. Elements in soils: total and extractable contents, solid phase speciation	214
--	-----

Contributors: Blaser, P.; Boularbah, A.; Bitton, G.; Calba, H.; Cazevieille, P.; Friedel, J.; Grafe, M.; Graf Pannatier, E.; Lienemann, P.; Luster, J.; Manceau, A.; McNear, D.H.; Mollier, A.; Morel, C.; Nowack, B.; Pezzotta, D.; Roberts, D.R.; Sas-Paszt, L.; Schwartz, C.; Sinaj, S.; Sparks, D.L.; Stepien, T.; Szwarc, M.; Tappero, R.; Turpault, M.-P.; Walthert, L.; Zimmermann, S.; Zwicky, C.

2.3. (Rhizosphere) soil solution: elemental and ionic composition, speciation	243
<i>Contributors:</i> Blaser, P.; Boccelli, R.; Boudot, J.-P.; Capri, E.; Cattani, I.; Courchesne, F.; Dessureault-Rompré, J.; Fragoulis, G.; Göttlein, A.; Graf Pannatier, E.; Heim, A.; Hinsinger, P.; Holm, P.E.; Jaillard, B.; Jones, D.; Koudelka-Hep, M.; Kruyts, N.; Løes, A.-K.; Luster, J.; Nourrisson, G.; Nowack, B.; Pezzotta, D.; Plassard, C.; Puschenreiter, M.; Sas-Paszt, L.; Sauvé, S.; Souche, G.; Stephan, C.H.; Stepien, T.; Temminghoff, E.J.M.; Tercier-Waerber, M.-L.; Turpault, M.-P.; Zhang, H.; Zhao, L.	
3. Organic Chemistry	
3.1. Root exudates and organic composition of plant roots	285
<i>Contributors:</i> Benizri, E.; Bianco, G.; Brunner, I.; Cataldi, I.; Delhaize, E.; Eldhuset, T.D.; Englmann, M.; Frommberger, M.; Gebefügi, T.; Guckert, A.; Heim, A.; Hirano, Y.; Jansa, J.; Jones, D.; Kraigher, H.; Kuzyakov, Y.; Luster, J.; Morel, J.L.; Neumann, G.; Ryan, P.; Schmitt-Kopplin, P.	
3.2. Element cycling and organic matter turnover	333
<i>Contributors:</i> Balesdent, J.; Ciavatta, C.; Dennis, P.; Finlay, R.; Gessa, C.E.; Gioacchini, P.; Gross, P.; Hacin, J.; Hodge, A.; Jones, D.; Killham, K.; Kuzyakov, Y.; Lecomte, A.; Minchin, P.E.H.; Nguyen, C.; Paterson, E.; Robin, C.; Schweiger, P.; Standing, D.; Warembourg, F.R.	
3.3. Soil organic matter and organic pollutants	360
<i>Contributors:</i> Blaser, P.; Capri, E.; Ciavatta, C.; Ciucani, G.; D’Orazio, V.; Francioso, O.; Garcia-Ramos, J.; Gessa, C.E.; Loffredo, E.; Luster, J.; Manunza, B.; Montecchio, D.; Provenzano, M.R.; Puglisi, E.; Sacchi, G.A.; Sanchez-Cortes, S.; Senesi, N.; Trapp, S.; Tugnoli, V.	
4. Microbiology, Biochemistry & Molecular Biology	
4.1. Microbial growth and visualisation of bacteria and fungi	378
<i>Contributors:</i> Biró, B.; Blaschke, H.; Capri, E.; Dazzo, F.B.; Dennis, P.; Duplessis, S.; Hartmann, A.; Hirsch, P.; Jansa, J.; Kohler, A.; Martin, F.; Matyssek, R.; Miller, A.; Nikolova, P.; Olsson, P.A.; Peter, M.; Puglisi, E.; Raidl, S.; Rothballer, M.; Sainz, M.J.; Schweiger, P.; Steinkellner, S.; Takasz, T.; Vanderleyden, J.; Vierheilig, H.; Vörös, I.; Wallander, H.	
4.2. Biochemistry	418
<i>Contributors:</i> Angerer, I.; Biró, B.; Friedel, J.; Füzy, A.; Gil-Sotres, F.; Leirós, M.C.; Neumann, G.; Pritsch, K.; Trasar-Cepeda, C.; Villnyi, I.	
4.3. Identification of single species and communities	443
<i>Contributors:</i> Contributors: Artursson, V.; Atallah, V.T.; Beguiristain, T.; Biró, B.; Bodrossy, L.; Brunner, I.; Cleyet-Marel, J.C.; Domergue, O.; Dreyfus, B.; Duplessis, S.; Corgié, S.; Finlay, R.D.; Freitag, T.; Grebenc, T.; Halbritter, A.; Hartmann, A.; Ihrmark, K.; Jansa, J.; Jansson, J.K.; Jeder, H.; Killham, K.; Ködöböcz, L.; Kohler, A.; Kraigher, H.; de Lajudie, P.; Leyval, C.; Mahmood, S.; Martin, F.; Mogyoróssy, T.; Nicol, G.; Osaki, M.; Peter, M.; Prosser, J.; Rangel-Castro, I. Rothballer, M.; Rosling, A.; Santos, J.; Sato, A.; Shinano, T.; Standing, D.; Steinkeller, S.; Taylor, A.; Tehler, A.; Vierheilig, H.; Wasaki, J.; Willems, A.; Zakhia F.	

4.4. Gene expression of single species and communities 478

Contributors: Balesdent, J.; Berge, O.; Duplessis, S.; Haichar, F.Z.; Karlsson, M.; Kohler, A.; Marol, C.; Martin, F.; Martin-Laurent, F.; Peter, M.; Schloter, M.; van Tuinen, D.; Vanderleyden, J.

5. Modelling

5.1. Rhizosphere models 487

Contributors: Claassen, N.; De Willigen, P.; Diederik, J.; Doussan, C.; Dunbabin, V.; Heinen, M.; Hopmans, J.W.; Kirk, G.; Kuzyakov, Y.; Mayer, U.; Mollier, A.; Nietfeld, H.; Nowack, B.; Oswald, S.; Roose, T.; Schnepf, A.; Schulin, R.; Seuntjens, P.; Silk, W.K.; Steingrobe, B.; Van Beinum, W.; Van Bodegom, P.

Part III: Colour Plates 518

Figures that are difficult to read in black and white printing, are repeated here in colour.

Editors: Fitz, Walter J.; Puschenreiter, Markus; Wenzel, Walter W.

Department of Forest- and Soil Sciences, Institute of Soil Science, BOKU -
University of Natural Resources and Applied Life Science Vienna, Peter
Jordan Strasse 82, 1190 Vienna, Austria

walter.fitz@boku.ac.at, markus.puschenreiter@boku.ac.at,
walter.wenzel@boku.ac.at

1.1.1. Introduction

Before rhizosphere characteristics can be assessed, plants have to be grown in proper growth systems where a defined rhizosphere can develop. Thereafter, sampling and measurements can be done on bulk and rhizosphere soil. Some experimental set ups do not deliver rhizosphere soil, e.g., hydroponic systems. Nevertheless such systems are also essential in rhizosphere research to assess for instance the qualitative and quantitative exudation pattern of plants after different pre-culture conditions such as nutritional status.

This chapter tries to give an overview of available growth systems suitable in rhizosphere research. Note that the method sheets available here do not cover the complete range of tools. The following methods are presented in this chapter:

- Growth systems using nets or membranes to develop a planar root-soil interface
- Growth systems based on visual division of bulk and rhizosphere soil
- Other growth systems designed for specific applications
- Hydroponic systems
- Non-soil materials as growth substrates

1.1.2. Growth systems using nets or membranes to develop a planar root-soil interface

Brief method description

The methods presented in this section allow investigations of rhizosphere and bulk soil, some allow the establishment of rhizosphere gradients, respectively. Depending on the aim of the experiment, measuring gradients in the rhizosphere is not always necessary. However, investigations on the dynamics of rhizosphere processes require the establishment of rhizosphere gradients.

Separating rhizosphere soil from adjacent roots using conventional techniques such as brushing, shaking and drying is a difficult task that almost unavoidably results in experimental artifacts from damaged and incompletely separated roots and root hairs. These artefacts may result in errors in the analysis of rhizosphere soil. To circumvent such artefacts experimental methods have been designed aiming at the separation of soil layers at defined distances from a root plane. They include rhizobox designs, soil-packets systems and rhizosphere study. These techniques commonly use porous nets and membranes to separate soil-root mixed compartments or root-only compartments from rhizosphere soil compartments. In box-like systems planar root mats develop on the surface of the root growth restricting membranes. Depending on the mesh width, root hairs may or may not grow into the soil compartment. A mesh size of about 20-30 µm allows penetration of root hairs and mycorrhizal fungi into the adjacent

compartment whereas a mesh size of 0.45 μm has been commonly employed to restrict root hair growth as well as hyphal growth (Li et al., 1991).

Sectioning of rhizosphere soil into root parallel soil layers can be achieved by separating the soil layers already during the experimental set up with nets and membranes (Youssef and Chino, 1988) or slicing of rhizosphere soil (Kuchenbuch and Jungk, 1982) (for detailed information on slicing techniques see **chapter 1.3**).

However, alternatively rhizobox systems can be equipped with sampling and measurement devices allowing non-destructive sampling and measurements, respectively: Micro suction cups for collection of bulk and rhizosphere solution, micro sensors for pH and redox measurements, time-domain reflectometry rods for water content measurements.

Basic references

Chaignon, V.; Hinsinger, P. 2003. A biotest for evaluating copper bioavailability to plants in a contaminated soil. *J. Environ. Qual.* 32: 824-833.

Corgié, S.; Joner, E.J.; Leyval, C. 2003. Rhizospheric degradation of phenanthrene is a function of proximity to roots. *Plant and Soil*, 257: 143-150.

Fitz, W.J.; Wenzel, Walter. W.; Wieshammer, G., Istenic, B. 2003. Microtome sectioning causes artifacts in rhizobox experiments. *Plant and Soil* 256: 455-462.

Gahoonia, T.S.; Nielsen, N. E. 1991. A method to study rhizosphere processes in thin soil layers of different proximity to roots. *Plant and Soil* 135: 143-146.

Helal, H.M.; Sauerbeck, D. 1981. Ein Verfahren zur Trennung von Bodenzonen unterschiedlicher Wurzelnahe. *Z. Pflanzenernähr. Bodenk.* 144: 524-527.

Hinsinger, P.; Gilkes, R.J. 1997. Dissolution of phosphate rock in the rhizosphere of five plant species grown in an acid, P-fixing mineral substrate. *Geoderma* 75: 231-249.

Joner, E.J.; Jakobsen, I. 1994. Contribution by two arbuscular mycorrhizal fungi to P uptake by cucumber (*Cucumis sativus* L) from P-32-labelled organic matter during mineralization in soil. *Plant and Soil* 163: 203-209.

Kuchenbuch, R.; Jungk, A. 1982. A method for determining concentration profiles at the soil-root interface by thin slicing rhizospheric soil. *Plant Soil* 68: 391-394.

Li, X.-L.; George, E.; Marschner, H. 1991. Phosphorus depletion and pH decrease at the root-soil and hyphae-soil interface of VA mycorrhizal white clover fertilized with ammonium. *New Phytologist* 119: 397-404.

Vetterlein, D.; Jahn, R. 2004. Combination of micro suction cups and time-domain reflectometry to measure osmotic potential gradients between bulk soil and rhizosphere at high resolution in time and space. *European Journal of Soil Science* 55, 497-504.

Wenzel, W.W.; Wieshammer, G.; Fitz, W.J.; Puschenreiter, M. 2001. Novel Rhizobox design to assess rhizosphere characteristics at high spatial resolution. *Plant Soil* 237: 37-45.

Youssef, R. A.; Chino, M. 1988. Development of a new rhizobox system to study the nutrient status in the rhizosphere. *Soil Sci. Plant Nutr.* 34: 461-465.

Application areas

Virtually all of these methods can be used for acid and alkaline soils as well as for artificial growth substrates.

Problems, constraints, do's and don'ts

Depending on the aim of the specific rhizosphere investigation, the choice of growth system material can greatly affect results. For instance acrylic material is well known to adsorb virtually no inorganic ions whereas organic pollutants are rapidly adsorbed and absorbed. Nets and membranes are used to restrict root growth to root only compartments or mixed soil-root compartments. Membrane and net material as well as the pore size may bias results. For instance nylon nets and membranes have been shown to adsorb negligible amounts of metals whereas organic compounds may be adsorbed in significant amounts.

Only systems based on root only compartments allow determination of the root biomass related to measured changes in the rhizosphere. Systems based on a modular design may be advantageous as changes in the experimental set up can be done easily.

All methods presented in this chapter provide a simplified geometry of the rhizosphere. The rhizosphere soil is created by a dense mat of roots. Therefore, measured parameters are a result from basal and apical root activities. Spatial variability along the root axis can

not be measured. Moreover, the high rooting density of the root mats may lead to an unrealistically intense expression of root-induced chemical changes (e.g. root exudation, modifications in pH and redox potential) in the adjacent rhizosphere compartments, - much higher than changes inducible by the activity of single roots.

Specific contribution to rhizosphere research

All these methods and tools provide the possibility to determine chemical, physical and biological changes of rhizosphere soil characteristics at defined distance to the roots. The systems presented by **11_Fitz**, **11_Gahoonia**, and **13_Vetterlein** allow the determination of rhizosphere gradients whereas the system presented by **11_Hinsinger_a** and **11_EI_Azab** allow only comparisons of bulk and rhizosphere soil. The systems of **11_Corgie** and **11_Le_Bayon** have been designed to investigate effects of mycorrhiza on soil parameters. Also the system used by Vetterlein has been earlier used to investigate chemical changes at the root-hyphae interface (30 µm net) and at the hyphae soil interface (0.45 µm membrane) (Li et al., 1991).

Related method sheets

ID	11_Corgie
Parameter	PAH degradation and microbial community structure as a function of distance to roots
Soil type	PAH spiked sand
Plant species	Ryegrass (<i>Lolium perenne</i>)
System	Compartment device
Method	In vivo compartment devices

ID	11_EI_Azab
Parameter	Bioavailability and phytotoxicity of metallic elements (Zn and Pb)
Soil type	Soil samples (applied to a Luvisol A horizon sample)
Plant species	adapted for Ryegrass(<i>Lolium perenne</i> L.)
System	Laboratory microcosm
Method	Soil contacting bioassay

ID	11_Fitz
Parameter	Rhizosphere gradients at high spatial resolution
Soil type	Any soil or solid substrates
Plant species	Any plant species, non-mycorrhizal
System	Lab microcosm
Method	Rhizobox system

ID	11_Gahoonia
Parameter	Rhizosphere soil sampling
Soil type	Best for sandy loams
Plant species	Crop plants, best for plants with fine root systems
System	Microcosms with soil
Method	Microcosms (thin slicing or special procedure for root hair studies)

ID	11_Hinsinger_a
Parameter	Any soil or soil solution parameter (except physical properties) + simplified access to soil-free roots for chemical analysis
Soil type	Any soil or solid substrates
Plant species	Any possible species, except those with strong tap or woody roots
System	Lab microcosm
Method	Mini-rhizobox system with soil or solid substrate

ID	11_Le_Bayon
Parameter	Soil nutrient dynamics at different distances from plant roots; plant and fauna interactions.
Soil type	All types
Plant species	All types
System	Microcosm
Method	Microcosm

1.1.3. Growths systems based on visual division of bulk and rhizosphere soil

Brief method description

The methods presented in this section allow visual differentiation of bulk and rhizosphere zones and/or the observation of root structure development through acrylic windows.

Two-dimensional (2D) box systems filled with e.g. agar enable detailed observations of the dynamics of seedling root growth and development. "Hohenheim" type rhizobox systems and rhizotrons are as well flat box-like growth systems with an acrylic window at the bottom. Boxes are fixed during growth at an angle of about 35°-45°. Development of the positive geotropic root growing roots

can be observed through the acrylic windows. The systems can be equipped with micro suction cups for collection of bulk and rhizosphere solution, micro sensors for pH and redox measurements, time-domain reflectometry rods for water content measurements. Alternatively the acrylic window can be removed to collect bulk and rhizosphere soil for chemical analysis or to apply dye indicators for visualisation of root-induced pH changes. A very famous example can be found on the book cover of Marschner's Mineral Nutrition of Higher Plants (Marschner, 1995).

Basic references

Dinkelaker, B.; Hahn, G.; Römheld, V.; Wolf, G.A.; Marschner, H. 1993. Non-destructive methods for demonstrating chemical changes in the rhizosphere I. Description of methods. *Plant Soil* 155/156: 67-70.

Futsaether, C.M.; Oxaal, U. 2002. A growth chamber for idealized studies of seedling root growth dynamics and structure. *Plant and Soil* 246: 221-230.

Göttlein, A.; Heim, A.; Matzner, E. 1999. Mobilization of aluminium in the rhizosphere soil solution of growing trees in an acidic soil. *Plant and Soil* 211: 41-49.

James, B.R.; Bartlett, R.J.; Amadon, J.F. 1985. A root observation and sampling chamber (rhizotron) for pot studies. *Plant Soil* 85:291-293.

Marschner, H.; Römheld, V. 1983. In vivo measurement of root-induced changes at the soil-root interface: Effect of plant species and nitrogen source. *Z. Pflanzenphysiol.* 111: 241-251.

Smit, A.L.; George, E.; Groenwold, J. 2000. Root observations and measurements at (transparent) interfaces with soil. In: Smit, A.L.; Bengough, A.G.; Engels, C.; Van Noordwijk, M.; Pellerin, S.; Van de Geijn, S.C. (eds.) *Root Methods. A Handbook.* Springer, Heidelberg, Germany, pp. 235-272.

Application areas

Hohenheim type box systems and rhizotrons represent simple systems allowing investigations at the single root level. Depending on the aim of the experiment this may be an advantage compared to root mat delivering systems as apical and basal regions can be investigated separately. However, only a limited amount of rhizosphere soil can be collected restricting the parameter range for chemical analysis.

It should also be kept in mind that roots growing along transparent observation windows represent only a two-dimensional system compared with the three-dimensional rhizosphere of plant roots, growing under real field conditions. These systems have been applied at laboratory and field scale experiments including large trees.

Specific contribution to rhizosphere research

All these systems and variations thereof have been successfully used for many years in rhizosphere research. A major advantage is their applicability on the single root level.

The 2D-system presented by **11_Futsaether** allows the observation of growth rate and branching patterns at high spatial and temporal resolution.

11_Eich_Greatorex, **11_Göttlein**, **11_Neumann** and **11_Sandnes** present applications of the Hohenheim-Box or rhizotron systems. More applications for collection of rhizosphere soil solution and root exudates can be found in **chapter 1.3.** and **3.1.**, respectively.

Related method sheets

ID	11_Eich_Greatorex
Parameter	Gradients of chemical elements in soils
Soil type	Acid-washed sand
Plant species	Spruce (<i>Picea abies</i> [L.] Karst), Timothy (<i>Phleum pratense</i>)
System	Root observation chamber
Method	Root observation chamber with ion-exchange resins as element sources

ID	11_Futsaether
Parameter	Root length, growth rate and branching patterns at high spatial and temporal resolution
Soil type	Artificial media – glass beads, agar/gel.
Plant species	Lentil, clover, annual bluegrass, Norway spruce
System	Laboratory system
Method	2D rhizobox system

ID	11_Goettlein
Parameter	Root development and high resolution extraction of soil solution
Soil type	Acid forest soils
Plant species	Oak, beech, spruce
System	field and laboratory
Method	Rhizotrones and root windows

ID	11_Neumann
Parameter	<i>Plant culture systems</i>
Soil type	All soils
Plant species	All species
System	Pot experiments, soil, solid substrates
Method	Construction and setup of rhizoboxes

ID	11_Sandnes_a
Parameter	Low molecular weight organic acids, pH, conductivity, mineral elements
Soil type	Acid forest soils
Plant species	Norway spruce (<i>Picea abies</i>) and silver birch (<i>Betula pendula</i>)
System	Root windows at field sites and field soil in rhizoboxes used indoors
Method	Root windows, rhizoboxes and micro suction cups

1.1.4. Other growth systems designed for specific applications

Brief method description

This chapter presents two growth systems for inoculation of plants with AM-fungi and measurement of volatile compounds.

The split box system of Vierheilig et al. (2000; **11_Vierheilig**) allows pre-colonization by an AMF on one side of a split-root system and later on or simultaneously be inoculation with an AMF or a pathogen on the second side of the split-root system.

11_Volante present a sophisticated microcosm for sampling and analysis of volatile compounds such as volatile organic pollutants.

More specialized rhizotron systems for the observation of root growth and/or ectomycorrhizal development are described in **12_Nikolova** and **41_Blaschke**.

Basic references

Vierheilig, H.; Garcia-Garrido, J.M.; Wyss, U.; Piche, Y. 2000. Systemic suppression of mycorrhizal colonization of barley roots already colonized by AM fungi. *Soil Biol. Biochem.* 32: 589-595

Related method sheets

ID	11_Vierheilig
Parameter	Inoculation of root systems with arbuscular mycorrhizal fungi or pathogenic fungi
Soil type	Any soil or artificial substrates like sand or expanded clays
Plant species	Any plant
System	Split-root system
Method	Split-root system for inoculation with different organisms at the same or different times

ID	11_Volante
Parameter	Concentration of volatile pollutants in contaminated substrates
Soil type	Quartz sand + powdered vermiculite (50% v/v)
Plant species	Leek (<i>Allium porrum</i>)
System	Mesocosm
Method	Mesocosm for plant growth and head space gas-chromatography

ID	12_Nikolova
Parameter	<i>In situ</i> fine-root architecture and growth dynamics
Soil type	Forest soil, organic litter layer
Plant species	Conifers and hardwoods
System	Slim case rhizotron
Method	Digital recording

ID	41_Blaschke
Parameter	Ectomycorrhiza: exploration types, hyphal network, rhizomorphs, and their response to chemical and physical properties of the soil environment
Soil type	forest soil, organic litter layer
Plantspecies	Conifers and hardwoods (eg <i>Picea abies</i> , <i>Fagus sylvatica</i>)
System	Microcosm
Method	Slim cases for digital recording of ectomycorrhiza formation <i>in situ</i>

1.1.5. Hydroponic Growth systems

Brief method description

Plants are grown in aerated nutrient solution which may be adjusted to the required growth condition (nutritional status, pH, pollutants, etc.). Cultivation in sterile conditions is possible. For stabilisation of pH, usually buffer

chemicals are added to the solution (e.g., MES – 2-morpholinoethanesulfonic acid). For maintaining alkaline conditions, an automated titration method has been established (Kopittke and Menzies, 2004).

Usually, plants are pre-grown in non-soil materials (e.g., perlite or mixtures of perlite and vermiculite (Zhao et al., 2001)). To avoid separately performed germination and testing, a unified system has been developed by Andersohn et al. (2002).

A special system for very small plants (e.g., *Arabidopsis thaliana*) has been developed by Huttner and Bar-Zavi (2003). Also here, germination and testing is performed in the same system. The use of small-volume plastic containers enables a large number of parallel experiments with a high number of individual plants.

A specific application is the culture in aeroponic conditions, where nutrients are delivered to plant roots by a mist, which is produced by a nebulizer system. This system enables rapid root growth and especially well developed root hairs which can be easily collected for further analysis (Zimmermann et al., 2003).

Basic references

Andersohn, C.; Fuchs, M.; Seyed-Mansouri, R.; Fleischmann, S.; Wilke, B.-M. 2002. A time-saving method for higher plant tests in hydroculture. *J. Environ. Qual.* 31: 697 – 699.

Heim, A.; Brunner, I.; Frey, B.; Frossard, E.; Luster, J. 2001. Root exudation, organic acids, and element distribution in roots of Norway spruce seedlings treated with aluminum in hydroponics. *J. Plant Nutr. Soil Sci.* 164: 519-526.

Huttner, D.; Bar-Zvi, D. 2003. An improved, simple, hydroponic method for growing *Arabidopsis thaliana*. *Plant Mol. Biol. Rep.* 21: 59-63.

Jones, J.B. 1997. *Hydroponics – a practical guide for the soilless grower*. St. Lucy Press. Boca Raton, FL

Kopittke, P.M.; Menzies, N.W. 2004. Control of nutrient solutions for studies at high pH. *Plant Soil* 266: 343-354.

Neumann, G.; Römheld, V. 2001. The release of root exudates as affected by the plant's physiological status. In: *The Rhizosphere – Biochemistry of organic substances at the soil-plant interface*; Pinton R, Varanini Z, Nannipieri P, Ed; Marcel Dekker: NY, pp. 41-93.

Zhao, F.J.; Hamon, R.E.; McLaughlin, M.J. 2001. Root exudates of the hyperaccumulator *Thlaspi caerulescens* do not enhance metal mobilization. *New Phytol.* 151: 613 – 620

Zimmermann, P.; Zardi, G.; Lehmann, M.; Zeder, C.; Amrhein, N.; Frossard, E.; Bucher, M. 2003. Engineering the root-soil interface via targeted expression of a synthetic phytase gene in trichoblasts. *Plant Biotechnol. J.*, 1: 353-360

Application areas

Hydroponic systems may be used for seedlings as well as for mature plants. Also, short and long term use is possible. Sterile conditions can be achieved, if needed.

Problems, constraints, do's and don'ts

If root exudates are assessed, treatment shocks after installing or changing the system should be considered. E.g., the exudation may be much higher immediately after the start of the experiments than a few days later. In sterile conditions, sterile filtration of treatment solutions is recommended.

Specific contribution to rhizosphere research

Root exudation pattern in response to specific growth conditions can be assessed. However, it should be considered that quantity and quality of exudates may be different in a soil environment.

Related Method Sheets

ID	11_Heim_a
Parameter	Not specified
Plant species	Norway spruce (<i>Picea abies</i>)
System	Hydroponic systems, growth chamber
Method	Hydroponic treatment at constant pH

ID	11_Bucher
Parameter	Root morphology and activities
Soil type	Soil free system
Plant species	Numerous, e.g. potato, tomato, maize, rapeseed, poplar, etc.
System	aeroponic
Method	Aeroponic culture

1.1.6. Non-soil materials as growth substrates

Brief method description

Soda glass beads (e.g., Sandnes and Eldhuset, 2003), perlite (e.g., Silber et al., 2003), polyethylen granulate (e.g., Battke et al., 2003), quartz sand (e.g., Belimov et al., 2003), filter wicks (Hacin et al., 1997), gel material and clay minerals (e.g., Hinsinger et al., 1992) may be used as substrate instead of soil.

Basic references

Battke, F.; Schramel, P.; Ernst, D. 2003. A novel method for in vitro culture of plants: cultivation of barley in a floating hydroponic system. *Plant Mol. Biol. Rep.* 21: 405-409.

Belimov, A.A.; Safronova, V.I.; Tsyganov, V.E.; Borisov, A.Y.; Kozhemyakov, A.P.; Stepanok, V.V.; Martenson, A.M.; Gianinazzi-Pearson, V.; Tikhonovich, I.A. 2003. Genetic variability in tolerance to cadmium and accumulation of heavy metals in pea (*Pisum sativum* L.). *Euphytica* 131: 25-35.

Hacin, J.; Bohlool, B.B.; Singleton, P.W. 1997. Partitioning of ¹⁴C-labelled photosynthate to developing nodules and roots of soybean (*Glycine max*). *New Phytol.* 137: 257-265.

Hinsinger, P.; Jaillard, B.; Dufey, J.E. 1992. Rapid weathering of a trioctahedral mica by the roots of ryegrass. *Soil Sci. Soc. Am. J.* 56: 977-982.

Sandnes, A.; Eldhuset, T.D. 2003. Soda glass beads as growth medium in plant cultivation experiments. *J. Plant Nutr. Soil Sci.* 166: 660-661.

Silber, A.; Xu, G.; Levkovitch, I.; Soriano, S.; Bilu, A.; Wallach, R. 2003. High fertilation frequency: the effects on uptake of nutrients, water and plant growth. *Plant and Soil* 253: 467-477.

Application areas

In contrast to soil, better adjustment to specific characteristics is possible. The use of gel allows dilution of soil or solid substrate in order to evidence changes which would otherwise not be detected (e.g. when using radioisotopes).

Problems, constraints, do's and don'ts

The material used may affect the percolate characteristics (release of ions, retain exudates). Sterile conditions are required. If a gel is used, drying out is possible.

Specific contribution to rhizosphere research

These methods allow the determination/observation of a big variety of plant (e.g. root growth) and/or solution parameter (e.g. root exudates) except physical properties. Also, access to soil-free roots for chemical analysis is possible.

Related method sheets

ID	11_Eich_Greatorex
Parameter	Gradients of chemical elements in soils
Soil type	Acid-washed sand
Plant species	Spruce (<i>Picea abies</i> [L.] Karst), Timothy (<i>Phleum pratense</i>)
System	Root observation chamber
Method	Root observation chamber with ion-exchange resins as element sources

ID	11_Hacin
Parameter	Monitoring root growth and infection by rhizobia
Soil type	None
Plant species	Soybean, beans, other large seeded legumes
System	Laboratory, split-root growth system
Method	Split-root growth system using plastic growth pouches

ID	11_Hinsinger_b
Parameter	Any soil or soil solution parameter (except physical properties) + simplified access to soil-free roots for chemical analysis
Soil type	Any soil or solid substrates suspended in a gel
Plant species	Any possible species, except those with strong tap or woody roots
System	Lab microcosm
Method	Mini-rhizobox system / gel

ID	11_Heim_b
Parameter	Not specified
Plant species	Norway spruce (<i>Picea abies</i>)
System	Solid substrate, growth chamber
Method	Treatment in perlite

ID	11_Sandnes_b
Parameter	Low molecular weight organic acids, pH, conductivity
Soil type	Artificial: Soda glass beads
Plant species	Norway spruce (<i>Picea abies</i>) and silver birch (<i>Betula pendula</i>)
System	Sterile plant cultivation in microcosms
Method	Microcosms using soda glass beads as solid growth substrate

Editors: Helmisaari, Heljä-Sisko¹⁾; Brunner, Ivano²⁾

¹⁾ Finnish Forest Research Institute, Vantaa Research Centre, P.O.Box 18, FIN-01301 Vantaa, Finland

helja-sisko.helmisaari@metla.fi

²⁾ Swiss Federal Institute for Forest, Snow and Landscape Research WSL, CH-8903 Birmensdorf, Switzerland

ivano.brunner@wsl.ch

1.2.1. Introduction

This chapter aims to give an overview on different methods on root research, particularly with respect to fine and small roots (diameter ≤ 5 mm). However, there is no established convention defining the diameter-size range of fine roots, but generally, roots smaller than 2 mm are regarded as fine roots. There is an urgent need for classifying roots into much smaller diameter classes and also classifying them according to their form of structure (primary, secondary) or branching order, because different roots may have different functions e.g. in nutrient uptake.

The main focus of this chapter is on the measurement of root biomass and root production (5 method sheets), of root growth (10 method sheets), of root architecture (8 method sheets), and of root hairs (2 method sheets). There are a number of different methods for studying fine roots that are not mentioned here. For those, basic references should be consulted (e.g. Smit et al. 2000).

Roots are hidden in the soil and thus not observable directly. Therefore, one of the difficulties about fine roots is the lack of agreement among methods in generalizing the factors controlling biomass production, life span, or turnover. No method has emerged best for all conditions, and the choice of the best study method depends on the research aim. There can be no ideal method for answering all questions. Often it will be advisable, sometimes also necessary, to

use two methods simultaneously. Every method has shortcomings, and most of the root-study methods are still tedious and time-consuming. Generally it can be said that the more accurate the method, the more laborious it is.

Basic reference

Smit, A.L.; Bengough, A.G.; Engels, C.; van Noordwijk, M.; Pellerin, S.; van de Geijn, S.C. (eds.). 2000. Root Methods: A Handbook. Springer, Berlin.

Specific contribution to rhizosphere research

Roots are not directly considered as a part of the rhizosphere, since rhizosphere is defined as the soil region on and around roots. However, roots are the immediate actors of the rhizosphere by influencing the soil around them by e.g. depositing dead cells, exuding organic molecules, or taking up nutritional elements and water.

1.2.2. Root bio- and necromass, biomass production, and turnover rate

Brief method description

Excavation is a useful technique for exploring the morphological characteristics, architecture or biomass of coarse root systems of individual plants. The quantitative exploration means measuring the lengths, diameters, weights, volumes etc. of particular root parts. It is best done by relating the data per unit area or per unit volume of substrate, and relating them

to other soil properties (Polomski and Kuhn 2002). Böhm (1979) gives a detailed description of different excavation methods.

Sampling of roots <5 mm in diameter should be done by soil coring or excavating monoliths (soil blocks) to avoid loss of fine roots. *Monoliths* are soil blocks in their original structure, extracted from their natural position with a specific depth and cross section. A soil monolith may be used for 1) obtaining a detailed view of the bulk root system of understorey plants within their surrounding soil; 2) determining the root mass in stony or rocky soils where traditional soil coring is impossible; and 3) assessing other root-soil relationships for plants grown under natural conditions.

The *soil core* method is based on sampling of a cylinder-shaped core of undisturbed soil (**12_Makkonen**). Soil core samples are frequently used for estimating the spatial distribution (biomass, necromass, root tips) and the volumetric relation of fine and small roots. The resulting data can be used as references in investigating many other aspects of root analysis (Polomski and Kuhn, 2002). Belowground net primary production (BNPP) has been estimated by collecting soil cores over the growing season (often monthly) and estimating BNPP based on changes in the mass of live and dead roots (Vogt et al., 1998). Sampling procedure, design, equipment, and the preparation of roots when using the soil core method are described in detail by Vogt et al. (1998).

An *ingrowth core* consists of a cylindrical gauze bag (mesh bag) with a specified volume filled with root-free substrate (**12_Helmisaari**). It is inserted into a properly drilled hole and left to become colonized by the roots of neighbouring plants. The ingrowth technique yields an estimate of the root growth dynamics of a plant (root biomass, turnover, production) and for the time of exposure (root growth rate) (Polomski and Kuhn, 2002).

All methods, where roots have to be sorted out from soil, require a *well-developed washing and sorting system*.

Roots are usually manually washed free of soil using sieves with a very small mesh size (usually 0.2 to 2 mm). It is important to select the sieve size according to the type of root material in order to minimise fine root loss during washing. If soil particles remain adhered to roots (as happens when taken from soils with a high clay content), some form of sodium metaphosphate can be used to disperse the soil particles (**12_Sainz_a**). After washing, roots are classified using a microscope into plant species, viability (living or dead), diameter classes (e.g. <1 mm, 1-2 mm, 2-5 mm) based on root morphology, consistency, and colour. After washing and sorting, root samples or part of them are usually processed for e.g. image analysis, tip counting, and dry weight measurements. Quality control of hand-sorting is important. It includes avoiding loss of roots and solving problems related to contamination of washed roots by soil particles. In a well-functioning system results are reliable, and losses of finest roots are minimal.

Recent studies suggested root *turnover rate* (annual root production divided by root biomass) to be calculated from third year ingrowth cores and multiplied by root biomass estimated from soil cores to get root *production* in a forest (**12_Lohmus**). This method could be more accurate and less laborious for estimating root biomass production than using repeated sequential soil coring since soil cores for estimating biomass could be sampled only once during the growing season. For third year ingrowth cores at least four samplings are needed to estimate the turnover rate (Ostonen et al. 2005).

Root production can also be calculated from turnover rate determined using the minirhizotrone technique (**12_Thorup_Kristensen**), and soil coring for biomass estimates. The method is based on continuously recording root intersections on acrylic transparent tubes (horizontally and vertically) permanently installed in the soil (Majdi 1996). Root turnover has also been determined by using tracer techniques (Gaudinski et al. 2000). However, the possible internal movement of e.g. C and N within the plant may make

it difficult to determine root age using tracer studies.

Basic references

Böhm, W. 1979. *Methods of Studying Root Systems*. Springer, Berlin.

Gaudinski, J.B.; Trumbore, S.E.; Davidson, E.A.; Zheng, S. 2000. Soil carbon cycling in a temperate forest: radiocarbon-based estimates of residence times, sequestration rates and partitioning of fluxes. *Biogeochemistry* 51:33-69.

Majdi, H. 1996. Root sampling methods - applications and limitations of minirhizotron technique. *Plant Soil* 185:225-258.

Ostonen, I.; Lõhmus, K.; Pajuste, K. 2005. Fine root biomass, production and its proportion of NPP in a fertile middle-aged Norway spruce forest: Comparison of soil core and ingrowth core methods. *For. Ecol. Manage.* 212: 264-277.

Polomski, J.; Kuhn, N. 2002. Root research methods. In: Waisel, Y.; Eshel, A.; Kafkafi, U. (Eds.). *Plant Roots: The Hidden Half*. Marcel Dekker, New York, pp. 295-321.

Smit, A.L.; Bengough, A.G.; Engels, C.; van Noordwijk, M.; Pellerin, S.; van de Geijn, S.C. (Eds.). 2000. *Root Methods: A Handbook*. Springer, Berlin.

Vogt, K.A.; Vogt, D.J.; Bloomfield, J. 1998. Analysis of some direct and indirect methods for estimating root biomass and production of forests at an ecosystem level. *Plant Soil* 200:71-89.

Application areas

No method of estimating root turnover has emerged as the best in all conditions. In spite of the draw-backs, the core sampling methods are still important in ecological root research. Sorting roots from *soil cores* or *monolith samples* is the best method for measuring actual and unaltered root bio- or necromass, or obtaining stand-level root samples for measuring e.g. morphological parameters. The *ingrowth core* method is suitable for 1) comparing root turnover or biomass production (potential) in different sites or stands, 2) investigating the seasonal variation, or 3) comparing the effects of different experimental treatments. *Minirhizotrones* (see **chapter 1.2.3 and 12_Thorup_Kristensen**) and *image analysis* are an established method for investigating root production, mortality, longevity, turnover, or the phenology of roots in relatively loose, nearly stone-free soils in areas well accessible to machines.

The *minirhizotrone* approach seems to hold the most promise for developing a better understanding of root demography under a wide range of conditions. However, traditional excavation methods, such as soil coring, are still the best field methods for obtaining samples for morphological and anatomical studies and determining root bio- or necromasses. Even if root turnover may be determined by various methods (ingrowth cores, minirhizotrones, tracers etc.), all having their strengths and weaknesses, also biomass data from soil coring is necessary for estimating root production.

Problems, constraints, do's and don'ts

Coring soil samples is difficult in stony soil, even if special cores may be used. If the soil is very stony, and sampling therefore not representative, a correction for the biomass values is required -if possible- when biomasses are scaled up for a larger area. The frequent sampling of *soil cores* for calculating root turnover has been done by e.g. utilizing the decision matrix but uncertainties especially in determining root necromass increase the possible error for estimating root production and turnover by using soil core data. Another error source is simultaneous birth and death during a sample interval which is not detected by using repeated soil coring for estimating root production. Root sorting is a labour-intensive phase of the work, and sorting results are highly dependent on having a skillful and experienced personnel.

Ingrowth cores require less labour for root sorting than soil cores but they also have drawbacks, especially related to the artificiality of the method, at least after placing the cores. The manipulation of the soil conditions in the bags may affect root growth, biasing the estimates for root production obtained by using ingrowth cores. However, studies in boreal forests show that during the third growing season after inserting the ingrowth cores the fine root turnover was on the similar level as that measured from soil cores.

Placing *minirhizotrone* tubes also disturbs the soil, and creates a partly artificial environment along the tube which

may affect the longevity and production results obtained with this technique. Considerable labour is also required to process the large number of root images. However, minirhizotrones have provided detailed, new information especially about the root life-span, such as mortality rates of roots of different age, diameter, at different depths in the soil.

Specific contribution to rhizosphere research

The described methods have not been developed specifically for rhizosphere related questions. However, being able to distinguish between living and dead roots is a prerequisite to define the rhizosphere.

Related method sheets

ID	12_Helmisaari
Parameter	Root biomass and necromass
Soil type	Upland forest soil
Plant species	Scots pine (<i>Pinus sylvestris</i>), Norway Spruce (<i>Picea abies</i>), Birch (<i>Betula sp.</i>), understory species groups (shrubs, grasses, herbs)
System	Field and laboratory studies
Method	Root ingrowth core method

ID	12_Lohmus
Parameter	Fine root biomass, production and turnover rate
Soil type	Forest soil
Plant species	Trees
System	Field and laboratory studies
Method	Combined method of ingrowth and soil cores

ID	12_Makkonen
Parameter	Root biomass and necromass
Soil type	Upland forest soil
Plant species	Scots pine (<i>Pinus sylvestris</i>), Norway Spruce (<i>Picea abies</i>), Birch (<i>Betula sp.</i>), understory species groups (shrubs, grasses, herbs)
System	Field and laboratory studies
Method	Soil core method

ID	12_Sainz_a
Parameter	Root biomass
Soil type	Any
Plant species	Any
System	Pots, auger and ingrowth field root samples
Method	Measurement of root weight

ID	12_Thorup_Kristensen
Parameter	Root density and rooting depth, root turnover, short term root growth responses
Soil type	In principle all soil types, but water logged or very stony soils are very difficult or impossible to work in
Plant species	Any
System	Field or lysimeter
Method	Minirhizotron

1.2.3. Root growth

Brief method description

Direct monitoring of root elongation can be done by the trench wall technique, using root observation windows or by using rhizotrones or minirhizotrones. Indirect monitoring of root elongation can be done by the magnetic resonance imaging or neutron radiography. Different types of profile walls, root windows or glass walls are in detail described by Böhm (1979).

The *trench wall technique* is especially useful for examining coarse roots (Mackie-Dawson and Atkinson, 1991) but has also been used for studying root growth and spatial distribution in the field with horizontal and vertical maps (profile-wall method; **12_Himmelbauer**). The *root window* is a transparent 6- to 8-mm-thick glass or a Plexiglas plate pressed onto the soil profile for investigating the morphological development of roots as well as phenological changes and the life span or mortality of individual roots (Polomski and Kuhn, 2002). *Rhizotrones* are subterranean glass chambers used for root studies, and *rhizolabs* are highly automated modifications of rhizotrones (Polomski and Kuhn, 2002). *Slim case rhizotrons*, commercially available for covering compact disks or DVD, are an inexpensive rhizotron approach to study fine-root growth e.g. in the organic layer of forest soils (**12_Nikolova**). *Root observation chambers* or *rhizoboxes* are laboratory systems that allow to observe root growth by the use of Plexiglas or glass plates (**12_Eich_Greatorex**, **12_Hodge**).

The *minirhizotrone technique* is based on observing and recording roots in situ through a transparent tube inserted into

the substrate through which the root is spread (**12_Mainiero**; **12_Thorup-Kristensen**). The same root segments can be measured directly and repeatedly. Thus, this technique is particularly appropriate in assessing root longevity and elongation (Majdi 1996). A minirhizotron equipment consists of a transparent tube inserted into the soil, an optical system introduced into the tube, and a video-processing system for storing and analyzing the recorded images (Polomski and Kuhn 2002).

The *magnetic resonance imaging* (MRI) is based on radio frequency pulses and magnetic field gradients. The images generated from this information reflect the spatial distribution of the water in the sample (**12_Futsaether**; **12_Segal**). Although it can be applied only in the lab, it is a non-destructive and non-invasive technique. *Computer tomography* (CT) is based on X-rays and is able to follow the root growth at various intervals (**12_Hargreaves**). *Neutron radiography* is another non-invasive technique to measure root growth in flat aluminium containers (**12_Menon**). This technique also allows to study water infiltration and dynamic water uptake.

Basic references

Böhm, W. 1979. *Methods of Studying Root Systems*. Springer, Berlin.

Mackie-Dawson L.A.; Atkinson, D. 1991. Methodology for the study of roots in field experiments and the interpretation of results. In: Atkinson, D. (Ed.). *Plant Root Growth: An Ecological Perspective*. Blackwell Scientific, Oxford: pp. 25-47.

Majdi, H. 1996. Root sampling methods - applications and limitations of minirhizotron technique. *Plant Soil* 185: 225-258.

Polomski, J.; Kuhn, N. 2002. Root research methods. In: Waisel, Y., Eshel, A., Kafkafi, U. (Eds.). *Plant Roots: The Hidden Half*. Marcel Dekker, New York, pp. 295-321.

Application areas; problems, constraints, do's and don'ts

Root windows and *soil profiles* are appropriate for studying the whole root system, and for describing spatial distribution patterns of roots in relation also to the local soil conditions. However,

they do not give detailed information at a single root level, e.g. root diameter or surface area. They are also laborious and destructive methods, and often allow installations of no or only few replications.

Rhizotrones or *rhizoboxes* do not provide a realistic picture of the relevant ecological variables as the soil placed in them is usually disturbed. Sand as a growth medium in a rhizobox is easy to wash away with a gentle stream of water even after several weeks of root growth. Tests with different sieve sizes to collect the sand and possible root fragments showed that root loss was negligible. Finer-textured soils and plants with faster growing root systems may be more difficult to use. Plants can be grown between the glass sheets only for a limited amount of time. Depending on the systems used, watering over the entire surface of the glass plate must be done daily to bring up to gravimetric weight, and care must be taken when the growth substrate is packed because it should stay *in situ* when the rhizobox is placed upright.

Minirhizotrones are not suitable for determination of the root topology or architecture because of limited observation space. Minirhizotron studies in natural conditions, especially in forests, are still scarce while more studies have been made in agricultural soils where the installation of the tubes is easier. Installing the tubes disturbs the soil. Therefore, the measurements should start after a time lag of one month - two years. A large number of minirhizotron tubes are required for reliable and representative (e.g. on stand level) results. Minirhizotron image analysis technique is developing fast but there are still problems in the visual discrimination of the roots from extraneous objects and soil background.

Specific contribution to rhizosphere research

These methods have not been developed specifically for rhizosphere related questions. However, a proper characterization of root growth is a prerequisite to define the rhizosphere. These methods are also suitable to observe the rhizosphere or to judge if a

soil is in an immediate contact to a root or not. This further allows to take samples from the rhizosphere at defined distances from roots. Furthermore, installations like root windows or rhizoboxes also allow to install micro suction cups for rhizosphere solution analysis (see **chapter 1.3.**). With neutron radiography or magnetic resonance imaging, root development as well as water uptake by roots of plants growing in containers can be monitored as a function of time. It is even possible to generate two- or three-dimensional reconstructions of entire intact root systems or water depletion zones surrounding the roots within the potting container.

Related method sheets

ID	12_Eich_Greatorex
Parameter	Root growth direction and length in relation to chemical gradients
Soil type	Acid-washed sand (acid forest soil)
Plant species	Spruce (<i>Picea abies</i>), Timothy (<i>Phleum pratense</i>)
System	Root observation chamber
Method	Visual evaluation and WinRhizo analysis of root scans

ID	12_Futsaether
Parameter	Anatomical and morphological studies of living tissue, root development and architecture, water flow velocities in living tissue, root-soil interface, bulk soil.
Soil type	Artificial media or soil mixtures free of ferromagnetic materials
Plant species	Most plant species
System	Laboratory studies
Method	Magnetic resonance imaging (MRI)

ID	12_Hargreaves
Parameter	Root growth and physical soil changes due to root growth, <i>in-situ</i>
Soil type	Any suited to system X-ray energy
Plant species	Any with root-diameter suited to system X-ray resolution (Medical X-ray CT- <i>Lupinus angustifolius</i> , <i>Pisum sativum</i>)
System	Pots in controlled conditions
Method	Non-invasive 3-D X-ray analysis of plant-soil interactions

ID	12_Himmelbauer
Parameter	Root growth, density and morphology, root spatial distribution
Soil type	Chernozem, serpentine soils, artificial substrates
Plant species	Cereals (barley, wheat, maize), <i>Thlaspi goesingense</i> , <i>Salix sp.</i>
System	Field and laboratory studies
Method	Field: profile-wall, soil-core method Laboratory: pot experiments, root cleaning procedure, rhizobox; Image analysis: root scans and digital photos

ID	12_Hodge
Parameter	Root proliferation (and demography) in N-rich organic patches & influence of AM fungi on root proliferation
Soil type	Loam soil
Plant species	Various grass species, <i>Plantago</i>
System	field soil, microcosms and temporally/spatially heterogeneous substrates (patches)
Method	Microcosms: various designs from essentially 2-D plates to larger containers with minirhizotron tubes

ID	12_Mainiero
Parameter	Fine root dynamics
Soil type	Stagnic cambisol
Plant species	<i>Fagus sylvatica</i> L. (European beech)
System	Field soil
Method	Minirhizotrone

ID	12_Menon
Parameter	<i>In situ</i> root growth, dynamic water uptake, infiltration
Soil type	Quartz sand, soils
Plant species	Any plant species
System	Flat aluminium containers
Method	Neutron Radiography

ID	12_Nikolova
Parameter	Fine root growth dynamics: root production, root mortality. Morphological parameters: fine-root length, diameter, surface area, fine-root phenology and ontogeny.
Soil type	Forest soil, organic litter layer
Plant species	Conifers and hardwoods
System	Slim case rhizotron
Method	Digital <i>in situ</i> recording of fine-root architecture and growth dynamics

ID	12_Segal
Parameter	Soil volumetric water content and root morphology
Soil type	Sandy soils
Plant species	barley, melon, cucumber
System	Pots
Method	Magnetic Resonance Imaging (MRI) - Proton density of hydrogen nuclei

ID	12_Thorup_Kristensen
Parameter	Root density and rooting depth, root turnover, short term root growth responses
Soil type	In principle all soil types, but water logged or very stony soils are very difficult or impossible to work in
Plant species	Any
System	Field or lysimeter
Method	Minirhizotron

1.2.4. Root architecture, anatomy and morphology

Brief method description

Root architecture and morphology may be studied in the field, in controlled greenhouse, or in microcosm experiments. Polomski and Kuhn (2002) provide a detailed description of different methods.

For *anatomical* studies thin transverse or axial sections of short roots can be cut using the freezing microtome cryostat, all sections are coloured (e. g. methylene-blue) and dimensions of different tissues are measured under a light microscope. The proportions of different tissues on cross section area of root are calculated (Ostonen and Löhmus, 2003).

Scanning combined with computerized *image analysis* is a widely used method for assessing *morphological root characteristics*, such as root length and diameter, mean surface area, volume, number of root tips, topology or branching (Löhmus et al., 1989; Ostonen et al., 1999). The derived functional characteristics, e.g. RTD (root tissue density), SRA (specific root area), SRL (specific root length) and SEA (specific endoderm area, for roots with primary structure), can be calculated from direct measurements of fine roots (**12_Ostonen**). Scanning can be done using photos, or root systems, or their segments from soil cores or ingrowth cores (Polomski and Kuhn, 2002). Digital photos

of a root monolayers developed in rhizoboxes may be taken and software analysed with RhizoTron (**12_Himmelbauer**).

Root image analysis performed on roots from greenhouse, microcosm, or field studies, on roots sorted from soil monoliths, soil cores, or ingrowth cores, or on root images digitally photographed using minirhizotrones is fast developing, and enables root morphological and anatomical characteristics be measured with higher precision and less labour than manual methods. For root image analysis the root samples are washed and separated from substrate by hand. The unstained root system is cut in shorter pieces and spread out in a glass tray (in water) for recording with flatbed scanner from below. The black & white thresholding is used to recognize plant roots. For scanning, software e.g. WinRHIZO (**12_Eich_Greatorex**; **12_Hargreaves**; **12_Nikolova**; **12_Ostonen**), ROOTEDGE (**12_Himmelbauer**), or Delta T-Scan (**12_Iglesias**; **12_Sainz_b**) is applied. Magnetic resonance imaging and computer tomography are non-invasive techniques providing the three-dimensional reconstruction of entire root systems with high resolution (**12_Futsaether**; **12_Hargreaves**).

Basic references

- Löhmus, K.; Oja, T.; Lasn, R. 1989. Specific root area: A soil characteristic. *Plant Soil* 119: 245–249.
- Ostonen, I.; Löhmus, K. 2003. Proportion of fungal mantle, cortex and stele of ectomycorrhizas in *Picea abies* (L.) Karst. in different soils and site conditions. *Plant Soil* 257: 435-442
- Ostonen, I.; Löhmus, K.; Lasn, R. 1999. The role of soil conditions in fine root ecomorphology in Norway spruce (*Picea abies* (L.) Karst.). *Plant Soil* 208: 283-292.
- Polomski, J.; Kuhn, N. 2002. Root research methods. In: Waisel, Y.; Eshel, A.; Kafkafi, U. (Eds.). *Plant Roots: The Hidden Half*. Marcel Dekker, New York: pp. 295-321.

Application areas; problems, constraints, do's and don'ts

The image analysis system provides a prompt evaluation of root morphological characteristics. It is faster, less laborious and more accurate than manual methods.

However, certain testing procedure should be done at the beginning of the processing related to root spreading, scanning density, root staining, scanning threshold value, etc. A good preparation of the root samples is essential. It can be very time-consuming if root samples are large and branched. The tip count is overestimated when a root is cut into shorter pieces. It is important to achieve precision: not overlap individual roots in the scan tray, arrange the roots segment randomly to achieve a uniform distribution of orientations of root segments. The staining is not necessary for coloured roots (tints and shades of brown) where a good contrast with the background can be obtained (**12_Iglesias**). The accuracy of scanning depends on the sample preparation and the scanning protocol.

Specific contribution to rhizosphere research

These methods have not been developed specifically for rhizosphere related questions. However, characteristics regarding root architecture, anatomy and morphology can be important basic information in rhizosphere studies. The information on root length, root surface area, or amount of root tips can give indirect information on the quantity and quality of the soil which is influenced by roots and thus has been transformed to rhizospheric soil.

Related method sheets

ID	12_Eich_Greatorex
Parameter	Root growth direction and length in relation to chemical gradients
Soil type	Acid-washed sand (acid forest soil)
Plant species	Spruce (<i>Picea abies</i>), Timothy (<i>Phleum pratense</i>)
System	Root observation chamber
Method	Visual evaluation and WinRhizo analysis of root scans

ID	12_Futsaether
Parameter	Anatomical and morphological studies of living tissue, root development and architecture, water flow velocities in living tissue, root-soil interface, bulk soil.
Soil type	Artificial media or soil mixtures free of ferromagnetic materials
Plant species	Most plant species
System	Laboratory studies
Method	Magnetic resonance imaging (MRI)

ID	12_Hargreaves
Parameter	Root growth and physical soil changes due to root growth, <i>in-situ</i>
Soil type	Any suited to system X-ray energy
Plant species	Any with root-diameter suited to system X-ray resolution (Medical X-ray CT- <i>Lupinus angustifolius</i> , <i>Pisum sativum</i>)
System	Pots in controlled conditions
Method	Non-invasive 3-D X-ray analysis of plant-soil interactions

ID	12_Himmelbauer
Parameter	Root growth, density and morphology, root system spatial distribution
Soil type	Chernozem, serpentine soils, artificial substrates
Plant species	Cereals (barley, wheat, maize), <i>Thlaspi goesingense</i> , <i>Salix sp.</i>
System	Field and laboratory studies
Method	Field: profile-wall, soil-core method Laboratory: pot experiments, root cleaning procedure, rhizobox; Image analysis: root scans and digital photos

ID	12_Iglesias
Parameter	Root length, number of root tips, root diameter
Soil type	Loamless mixes (peat, sand, bark and compost)
Plant species	<i>Quercus robur</i> , <i>Thuja plicata</i> , <i>Cotoneaster horizontalis</i> , <i>Evonymus japonicus</i>
System	Greenhouse trials in modules
Method	Root image analysis by Delta-T SCAN

ID	12_Nikolova
Parameter	Fine root growth dynamics: root production, root mortality. Morphological parameters: fine-root length, diameter, surface area, fine-root phenology and ontogeny.
Soil type	Forest soil, organic litter layer
Plant species	Conifers and hardwoods
System	Slim case rhizotron
Method	Digital <i>in situ</i> recording of fine-root architecture and growth dynamics

ID	12_Ostonen
Parameter	Specific root area (SRA), root tissue density (RTD), specific root length (SRL) and specific endoderm area (SEA); dimensions and proportions of mantle, cortex and stele of ectomycorrhizas
Soil type	Forest soil
Plant species	Ectomycorrhizal tree species
System	Field and laboratory studies
Method	Phycentric approach of morphological and anatomical fine root parameters

ID	12_Sainz_b
Parameter	Root architecture
Soil type	Any
Plant species	Any
System	Pots, field soil cores
Method	Image analysis

1.2.5. Root hairs

Brief method description

Root hairs are tiny outgrowths of some surface cells of plant roots that greatly increase the area available for the absorption of water and nutrients. The layer of the root's epidermis that produces root hairs is known as the piliferous layer. A root hair survives for a short time only and does not develop into a root. Each root hair is made of a single cell. At the root tip mitosis cell division is very active making new cells for growth to replace the root hair cells that die.

Most of the root hair studies in soils have been made on cereals and other grasses (Böhm, 1979). For root hair observations, gently washed cereal roots are placed in water in Petri dishes and examined by microscope for measuring e.g. diameter, length and surface area of root hairs by appropriate software on representative parts of the root (**12_Gahoonia**; **12_Loes**). Living root hairs have also been distinguished from dead ones by e.g. staining them with 1% solution of neutral red (Mc Elgunn and Harrison, 1969). Root hair studies have recently developed in the field of cell and molecular biology (Ridge and Emons, 2000, Ridge and Katsumi, 2002).

Basic references

Böhm, W. 1979. *Methods of Studying Root Systems*. Springer, Berlin.

McElgunn, J.D.; Harrison, C.M. 1969. Formation, elongation and longevity of barley root hairs. *Agron. J.* 61:79-81.

Ridge, R.W.; Emons, A.M.C. 2000. *Root Hairs: Cell and Molecular Biology*. Springer, Tokyo.

Ridge, R.W.; Katsumi, M. 2002. Root hairs: Hormones and tip molecules. In: Waisel, Y.; Eshel, A.; Kafkafi, U. (Eds.). *Plant Roots: The Hidden Half*. Marcel Dekker, New York: pp. 83-91.

Application areas; problems, constraints, do's and don'ts

The variation in root hair length in field grown cereals is considerable. The root hair development and length is very dependent of the growth media. Some root hairs are remarkably long, and care should be taken to avoid misinterpretation with fungal hyphae (often branched).

Specific contribution to rhizosphere research

Since root hairs are parts of a root that very actively influence the rhizosphere, their proper characterization can be an essential part of background information within a rhizosphere related study. Although root hair length measurement does not directly contribute to the rhizosphere research, the information on root hair lengths can give indirect information on the amount of soil that is influenced by root hairs.

Related method sheets

ID	12_Gahoonia
Parameter	Root hairs
Soil type	Any, but works better in sandy soils
Plant species	Any
System	Pots, field soil
Method	Sampling and cleaning of soil-grown roots for root hair studies

ID	12_Loes
Parameter	Root hair length
Soil type	Agricultural soil
Plant species	Wheat, barley
System	Field
Method	Microscopy and image analysis

Editor: Göttlein, Axel
TU München, Am Hochanger 13, 85354 Freising, Germany
goettlein@forst.tu-muenchen.de

1.3.1. Introduction

This chapter deals with the definition and the sampling of rhizosphere soil and rhizosphere soil solution as opposed to bulk soil or bulk soil solution. The following methods are covered by individual methods sheets:

- Separation of bulk and rhizosphere soil by shaking and/or washing the root system
- Thin slicing of (frozen) soil
- Collection of soil solution with tension lysimeters
- Collection of soil solution by centrifugation techniques
- Collection of soluble compounds with filter papers, gels etc.

The distinction between rhizosphere and bulk soil by separating different compartments in rhizobox-like growth containers with membranes is covered in **chapter 1.1.** In this context also the „rhizobag technique“ should be mentioned, where bags of nylon meshes are used to separate rhizosphere from non-rhizosphere soil (McGrath et al., 1997).

McGrath, S.P.; Shen, Z.G.; Zhao, F.J. 1997. Heavy metal uptake and chemical changes in the rhizosphere of *Thlaspi caerulescens* and *Thlaspi ochroleucum* grown in contaminated soils. *Plant Soil* 188 : 153-159.

1.3.2. Separation of bulk and rhizosphere soil by shaking and/or washing the root system

Brief method description

Sampling of rhizosphere soil by extracting and shaking the root system is an easy to use method. Although it has

been used very often, detailed descriptions do hardly exist.

Problems, constraints, do's and don'ts

The results of the method are generally not very well defined, because soil texture and actual soil moisture are strongly influencing the amount of soil adhering to the root system when removing it from the bulk soil. These parameters also have an influence on the amount of soil that is falling down when shaking the root system as well as on the amount of soil that keeps sticking to the roots after the shaking procedure. Thus the method presented by **13_Turpault** tries to standardize this procedure by drying the root system before shaking. The use of this method results in three soil fractions: The bulk soil, the rhizosphere soil, which is the soil that spontaneously detaches from the roots after drying, and the „rhizosphere interface“, which is the soil that is falling off when shaking the dried root system.

Also **13_Berge** use the shaking procedure to separate rhizosphere soil and bulk soil. However, after shaking off non-rhizosphere soil they are washing the root system in water to remove the rhizosphere soil and perform microbial studies on both, washed roots and rhizospheric soil. Both methods have advantages and disadvantages. A main disadvantage of the method of **13_Turpault** is, that by shaking the dried root system not all adhering soil will be removed. Thus in contrast to the washing procedure quantitative results are difficult to achieve. On the other hand, washing the root system with water alters the chemical and physical status of rhizosphere soil. So it very much depends on the focus of a particular experiment,

which one of the two methods is the best choice.

Related method sheets

ID	13_Berge
Parameter	Ratio of root-adhering soil (RAS) to root tissue (RT) dry masses (RAS/RT ratio), i.e. rhizosphere soil aggregation
Soil type	Any
Plant species	Any
System	Microcosm or field soil
Method	Shaking and washing of root systems

ID	13_Turpault
Parameter	Sampling of rhizosphere soil for physico-chemical and mineralogical soil analyses
Soil type	Acid forest soil
Plant species	Mono-species stand of any forest species
System	Field soil
Method	Physical separation based on drying and shaking

1.3.3. Thin slicing of (frozen) soil

Brief method description

Thin slicing techniques have the need of special growth systems (see also **chapter 1.1.**), that allow the development of a root mat at the interface to the test soil. The method of **13_Nielsen** describes such a growth system as well as the slicing procedure. A modification of this method for root hair studies is given in **11_Gahoonia**. Both methods sheets describe, that thin slicing is done after the soil is frozen in liquid nitrogen to avoid smearing when slicing the soil with a microtome. By contrast, **13_Fitz** present a system, where thin slicing of rhizosphere soil can be done without freezing the soil.

Problems, constraints, do's and don'ts

It depends on the experimental setup, which of the two methods is more favourable. A freezing microtome has advantages, when small growth systems and soils with higher clay content are used. For sandy soils and bigger growth systems the method of **13_Fitz** is clearly more practicable and also avoids a

possible alteration of soil chemical and biological properties by freezing the soil.

Related method sheets

ID	11_Gahoonia
Parameter	Rhizosphere soil sampling
Soil type	Best for sandy loams
Plant species	Crop plants, best for plants with fine root systems
System	Microcosms with soil
Method	Microcosms (thin slicing or special procedure for root hair studies)

ID	13_Fitz
Parameter	Any chemical or biological plant-induced gradient in the rhizosphere
Soil type	Any
Plant species	Any
System	Rhizobox
Method	Sectioning of rhizosphere soil

ID	13_Nielsen
Parameter	Dynamics of root induced processes and nutrient depletion in rhizosphere soil near root mat
Soil type	Sandy loam
Plant species	Rape
System	Rhizobox
Method	Thin slicing of frozen undisturbed soil by freezing microtome

1.3.4. Collection of soil solution

Brief method description

The general approach of sampling soil solution with zero-tension and tension lysimeters is covered by **13_Graf_Pannatier**. A miniaturized system for the collection of rhizosphere soil solution is presented by **13_Goettlein** using micro suction cups with an outer diameter of 1 mm which are made of ceramics. These micro suction cups may be installed in rhizotrones/rhizoboxes or in the field (see also **11_Goettlein** and **11_Sandnes_a**) after drilling a hole at the desired positions. The micro suction cups may be installed directly to the rhizosphere (and to the bulk soil as reference) or as a grid in front of the growing root system. The root will enter this grid and the changes in soil solution chemistry then can be observed. A modification of micro suction cups for the collection of organic acids is described by **13_Dessureault_Rompre**. **23_Puschenreiter_b** presents a micro

sampling system that consists of a nylon membrane which is mounted to the end of a polyacrylic rod (diameter 5 mm) and allows sampling of soil solution at defined distances from the root. Micro suction cups may also be combined with micro tensiometers or micro-TDR as presented in **13_Vetterlein**. Another method to gain soil solution is centrifugation (**13_Lundstroem**).

Basic references

Wolt, J. 1994. Soil solution chemistry: Applications to environmental science and agriculture. John Wiley and Sons, New York.

Tinker, B.P.; Nye, P.H. 2000. Solute movement in the rhizosphere. Oxford University Press.

Göttlein, A.; Hell, U.; Blasek, R. 1996. A system for microscale tensiometry and lysimetry. *Geoderma* 69, 147-156.

Application areas

So far, applications of the micro suction cup method have focused on the influence of growing tree roots on major inorganic constituents of soil solution in acid forest soils. There is no obvious reason, however, why the method should not work in alkaline soils or with plants other than trees.

Problems, constraints, do's and don'ts

According to **13_Eldhuset_a** watering of the rhizotrons from the top may affect adversely concentration gradients in the rhizosphere. Thus watering via porous polymer tubing or small ceramic cups set to a water potential of about -60hPa is strongly recommended (compare **11_Goettlein**). In sandy soils, however, there are often problems to collect soil solution by micro suction cups, because such soils have a low water holding capacity and there often is a bad contact of the micro suction cup to the soil matrix (**13_Eldhuset_a**).

The small sample volumes, typically less than 500 µl, require the use of microanalytical methods like capillary electrophoresis, ISFET-pH measurement, ICP methods with micro-sample introduction devices (see **23_Goettlein_b**). Also HPLC-methods

can be used, as done by **13_Eldhuset_b** or **13_Dessureault_Romp** for organic acids. Problems may arise, if the material of the micro suction cups (and/or the tubings) adsorbs a given analyte or contaminates the extracted solution with it. **13_Luster** tested ceramic micro suction cups, hollow fibers (polyvinyl alcohol) and polymeric tubes (most likely polyethersulfone) with respect to their sorption of Zn, Cu, Cd and Pb in weakly acid and alkaline solutions containing different levels of DOC. Their results indicate, that depending on pH and DOC-content of the solution, depending on the type of the porous material and depending on the analyte there may be big differences in sorption. In addition, **13_Thiele** tested ceramic micro suction cups, nylon membranes and polyethersulfone hollow fibers for adsorption of organic acids and for permeability for microorganisms. They found ceramic capillaries and nylon membranes to be permeable for microorganisms and polyethersulfone fibers to adsorb organic acids to a small extent. Thus when designing an experiment using porous media to extract soil solution, there should be done some tests with respect to a possible interference of the analyte with the sampling system using a test solution, the composition of which should be close to the real soil solution of the experiment.

The centrifugation method presented in **13_Lundstroem** is especially useful for getting soil solution out of the mor layer. However, because this method needs destructive sampling it is of limited suitability for monitoring purposes. Because high speed centrifugation also removes water from the very small soil pores, the chemical composition of soil solution gained by centrifugation differs from soil solution obtained by zero-tension or tension lysimeters.

Related method sheets

ID	11_Goettlein
Parameter	Root development and high resolution extraction of soil solution
Soil type	Acid forest soils
Plant species	Oak, beech, spruce
System	Field and laboratory
Method	Rhizotrones and root windows

ID	11_Sandnes_a
Parameter	Low molecular weight organic acids, pH, conductivity, mineral elements
Soil type	Acid forest soils
Plant species	Norway spruce (<i>Picea abies</i>) and silver birch (<i>Betula pendula</i>)
System	Root windows at field sites and filed soil in rhizoboxes used indoors
Method	Root windows, rhizoboxes and micro suction cups

ID	13_Dessureault_Rompre
Parameter	Collection of rhizosphere soil solution for organic acid analysis
Soil type	Agricultural topsoil
Plant species	White lupine (<i>Lupinus albus</i>)
System	Rhizobox
Method	Micro tension lysimeters

ID	13_Eldhuset_a
Parameter	Rhizosphere soil solution
Soil type	Acid forest soil
Plant species	Norway spruce (<i>Picea abies</i>)
System	Root window in the field; rhizobox in the lab
Method	Sampling of soil solution with micro suction cups

ID	13_Eldhuset_b
Parameter	Organic acids, NH₄⁺, K⁺, Ca²⁺, Mg²⁺ in rhizosphere and bulk soil solution
Soil type	Acid washed sand
Plant species	Timothy (<i>Phleum pratense</i>)
System	Rhizobox
Method	Sampling with micro suction cups; analysis by HPLC and capillary electrophoresis

ID	13_Goettlein
Parameter	High resolution sampling of soil solution
Soil type	Acid forest soils
Plant species	Beech, Spruce, Oak
System	Field and laboratory
Method	Micro suction cups

ID	13_Graf_Pannatier
Parameter	Sampling of soil solution
Soil type	Acid and calcareous forest soils
System	Field and model ecosystems
Method	Zero-tension lysimetry; tension lysimetry

ID	13_Lundstroem
Parameter	Collection of soil solution
Soil type	Forest soil
Plant species	Pine, spruce
System	Field soil
Method	Centrifugation drainage

ID	13_Luster
Parameter	Collection of rhizosphere soil solution, trace metal analysis
System	Laboratory test of materials
Method	Micro tension lysimeters

ID	13_Thiele
Parameter	Collection of soil solution for organic acid analysis
System	Laboratory test of micro suction cups
Method	Micro tension lysimeters

ID	13_Vetterlein
Parameter	Changes in soil water content and soil solution composition in the rhizosphere with time
Soil type	Artificial substrates based on quartz of different texture classes (sand, silt, clay)
Plant species	<i>Zea mays</i>
System	compartment system
Method	Combination of micro suction cups, microtensiometers and time-domain reflectometry

ID	23_Goettlein_b
Parameter	Metal speciation in micro samples of soil solution
Soil type	Acid forest soils
Plant species	Oak
System	Rhizotrones, root windows
Method	Capillary Electrophoresis (CE) and ICP-OES with microinjection

ID	23_Puschenreiter_b
Parameter	Trace elements and heavy metals in rhizosphere soil solution
Soil type	Any
Plant species	Any
System	Rhizobox
Method	Sampling with micro tension lysimeters; analysis with ICP-MS or GF-AA

1.3.5. Collection of soluble compounds with filter papers, gels etc.

The localized application of sorption media is another method to collect soluble soil compounds in the rhizosphere, as presented by **31_Neumann_b**. This method also has the advantage to be non-destructive when used in combination with rhizoboxes or root windows and that a wide range of compounds can be trapped and analyzed with different sorption media. However, it will be in most cases unclear, to which extent the compound of interest is trapped by the sorption medium. Thus this method is more suited for qualitative and semi-quantitative comparisons of different soil zones or treatments, or temporal developments.

Diffusive gradients in thin-films (DGT) are also a methodological approach to extract ions from the soil. This method is

presented by **23_Zhang_b** and is dealt with in more detail in **chapter 2.3.**

Related method sheets

ID	23_Zhang_b
Parameter	Effective concentrations C_e (As, Zn, Cu, Cd, Pb) in soil solution
Soil type	All soil types
Plant species	<i>Lepidium heterophyllum</i> , <i>Triticum aestivum</i> L., <i>Lepidium sativum</i> , <i>Pteris vittata</i> L.
System	field soils and microcosm
Method	DGT (diffusive gradients in thin-films)

ID	31_Neumann_b
Parameter	Collection of root exudates and rhizosphere soil solution from soil-grown plants
Soil type	All soils
Plant species	All species
System	Rhizoboxes, field studies with root windows
Method	Localized collection by use of sorption media

Editors: Frey, Beat¹⁾; Turnau, Katarzyna²⁾

¹⁾Swiss Federal Institute for Forest, Snow and Landscape Research WSL,
CH-8903 Birmensdorf, Switzerland

beat.frey@wsl.ch

²⁾ Institute of Environmental Sciences, Jagiellonian University, Gronostajowa
7, 30-387 Kraków, Poland

turnau@eko.uj.edu.pl

2.1.1. Introduction

Many aspects of studying roots and root-associated microorganisms require knowledge on the concentrations and distribution of elements, to understand the uptake and transport of ions and their roles in metabolic processes and water relationships. This chapter deals with classical and modern analytical methods to quantify elements in the roots, to localize and visualise the distribution of elements (e.g. heavy metals) in the roots and mycorrhizas. The following methods are covered in this chapter:

- plant digests
- elemental and ionic analysis of digests
- histochemical methods
- X-ray microanalytical methods

Specific contribution to rhizosphere research

None of these methods have been developed specifically for rhizosphere related question. However, elemental contents in roots and mycorrhizal fungi are often determined with the aid of these methods.

2.1.2. Plant digests

Brief description of method

Dried, ground and weighed plant tissue samples are prepared for elemental analysis through the destruction of organic matter. The two commonly used methods

of organic matter destruction are dry ashing (high-temperature combustion) and wet ashing (acid digestion). Both methods are based on the oxidation of organic matter through the use of heat and/or acids. A number of procedures have been developed that utilize microwaves as source of heat. These are generally classified as closed or open vessel. Closed vessel (Parr Bomb) utilizes heat and pressure to increase reaction rate and to decrease digestion time.

Basic references

Jones, J.B.; Case, V.W. 1990. Sampling, handling, and analyzing plant tissue samples, pp. 389-427. In: R.L. Westerman (Ed.), Soil Testing and Plant Analysis. Third edition. SSSA Book Series 3. Soil Science Society of America, Madison, WI.

Kalra, Y.P. 1998. Handbook of Reference Methods for plant analysis. 1998, CRC Press, Boca Raton, Florida, USA

Watson, M.E.; Isaac, R.A. 1990. Analytical instruments for soil and plant analysis, pp. 691-740. In: R.L. Westerman (Ed.), Soil Testing and Plant Analysis. Third edition. SSSA Book Series 3. Soil Science Society of America, Madison, WI.

Application areas

Wet ashing is recommended for plant material high in Si (e.g. Graminaceae) or containing volatile elements (arsenic, mercury, or selenium) that may be lost during the dry ash procedure.

Problems, constraints, do's and don'ts

Sample material must be ground to pass through a 0.5 – 1.0 mm mesh size to ensure homogeneity. Before use, all glassware, plasticware, and Teflon digestion vessels should be thoroughly rinsed, first with a diluted acid (e.g. HCl) and then with redistilled or doubly-deionized water. It is essential that the filtrate does not contain any particles that could clog the analyzers sample introduction device (for an overview on analytical instrumentation see below). Critical factors in dry ash procedures include selection of ashing vessel, placement in furnace, ashing temperature, time, selection of acid to solubilize the ash, and final volume, whereas critical factors in wet digestion procedures include selection of the digestion vessel, temperature and control, time, the digestion mixture, and final volume. Special safety precautions are required for microwave digestion.

Related method sheets:

ID	21_Brunner
Parameter	Total element concentrations in fine roots
Soil type	forest soils
Plant species	Picea abies, Pinus montana, Pinus cembra
System	Samples from forest
Method	CN-analyser, ICP-AES

ID	21_Jansa
Parameter	Total content of nonvolatile elements in plant shoots and roots
Soil type	any
Plant species	any (provided roots can be washed out from the soil and cleaned)
System	both field and pot experiment samples
Method	Atomic spectrometry, ion chromatography, and colorimetry of plant digests (dry ashing)

ID	21_Sainz
Parameter	Concentration of P, K, Ca, Mg, Na, Fe, Mn, Cu and Zn in plant material
Plant species	Any plant species
System	Material from field, greenhouse, growth chamber
Method	UV/VIS spectrophotometry (colorimetry), atomic emission/absorption spectrometry, ICP-OES of plant digests

ID	21_SasPaszt
Parameter	P, K, Mg, Ca, total N and microelements B, Cu, Fe, Mn, Zn in plant material
Soil type	Mineral soil from pomological orchards
Plant species	Strawberry, apple, pear
System	Greenhouse and field experiments with mineral soils
Method	Atomic spectrometry of plant digests (wet ashing), Kjeldahl N

2.1.3. Elemental analysis of digests

Brief method description

Element analysis of plant digests can be carried out by any method that is able to analyse total elemental or ionic contents in solutions like flame or graphite furnace atomic absorption or emission spectrometry (AAS, AES), inductively-coupled plasma atomic emission or mass spectrometry (ICP/AES, also abbreviated as ICP/OES; ICP/MS), but also colorimetry (mainly for P as phosphate) or ion chromatography (for Cl as chloride, S as sulfate, N as nitrate). Details on the principle operation and use of these analytical methods for conducting root and fungal tissue analysis have been described in the references below.

Basic references

Dulski, T. R. 1999. Trace elements analysis of metals: Methods and Techniques. Marcel Dekker, Inc., New York

Kalra, Y. P. 1998. Handbook of Reference Methods for plant analysis. CRC Press, Boca Raton, Florida, USA

Walinga, I.; Van der Lee, J.J.; Houba, V.J.G.; Van Vark, W.; Novozamsky, I. 1995. Plant analysis manual. Kluwer Academic Publishers. Dordrecht, NL

Westerman R.L. 1990. Soil Testing and Plant Analysis. Third edition. SSSA Book Series 3. Soil Science Society of America, Madison, WI.

Application areas

The above-mentioned analytical methods were used for routine inorganic elemental analysis of plant tissue. From the point of view of rhizosphere research, macro- and micronutrients, trace elements and heavy metals can be determined in root and fungal tissues. The ICP-AES

instrument is the principal equipment in most contemporary plant analysis laboratories. It allows rapid, simultaneous multielement analysis of biological samples.

Problems, constraints, do's and don'ts

For specific problems with sensitivity, detection limits, precision, accuracy and occurrence of spectral interferences the reader should refer to basic references.

Related method sheets:

Same as for **chapter 2.1.2.**

2.1.4. Heavy metal localization using light microscopy

Brief method description

A few simple methods allowing for heavy metal detection are available to be used at the level of the light microscope or under the dissecting microscope. The most useful in the rhizosphere research are the sodium rhodizonate and dithizone techniques. Both substances form colored complexes. Sodium rhodizonate is used specifically to show Pb at pH 2.8. It reacts with several heavy metals at pH 7. Dithizone dissolved in acetone is useful in detection of Pb, Cd, Zn, Co, Ni, Cr, Fe at much lower concentrations (10^{-5} M of metal salts in aqueous solutions) than by the previous method. Both methods are very useful for pilot screening of heavy metal distribution in root and mycorrhiza samples. They give a general view of the situation and allow the selection of the most promising samples for further investigations with more specific methods including EDS, EELS, ESI or PIXE.

Basic references

Seregin, I.V.; Ivanov, V.B. 1997. Histochemical investigation of cadmium and lead distribution in plants. *Rus. J. Plant Phys.* 44: 791-796.

Turnau, K.; Kottke, I. 2005. Fungal activity as determined by micro-scale methods with special emphasis on interactions with heavy metals. In: *The Fungal Community*. J. Dighton, J.F. White, P.Oudemans (eds.), CRC Press, Boca Ration pp. 287-306.

Wierzbicka, M. 1987. Lead translocation and localization in *Allium cepa* roots. *Can. J. Bot.* 65: 1851-1860.

Wierzbicka, M.; Potocka, A. 2002. Lead tolerance in plants growing on dry and moist soils. *Acta Biol. Crac. Ser. Bot.* 44: 21-28.

Application areas

Both methods were successfully used to study heavy metal uptake by plants, at lethal and nonlethal concentrations, giving information on the rate of element transport. In the case of mycorrhizospheric studies they were used to select mycorrhizal fungi or mycorrhizal morphotypes that accumulate heavy metals, resulting in the biofiltering effect of the extraradical and intraradical mycelium. It was used in the case of arbuscular, ericoid, orchid and ectomycorrhizas collected from various industrial wastes or cultivated in pots or rhizoboxes filled with substrata rich in heavy metals.

Problems, constraints, do's and don'ts

The time of incubation in solutions needs to be determined experimentally and it depends mainly on the plant material. The material for the tests should be treated with solutions of rhodizonate or dithizone directly after harvesting. If washing of the material is needed, it should be done as fast as possible. Only material stained in rhodizonate dissolved in water was shown to be useful in further analysis for example by EDS. In other cases possible redistribution before or during further preparation steps has to be assessed.

Related method sheet

ID	21_Turnau_c
Parameter	heavy metal detection at the light microscope level
Soil type	industrial wastes or substrata enriched in heavy metals
Plant species	various plant species including those forming endo- and ectomycorrhiza
System	field material, rhizobox or pot material
Method	rhodizonate and dithizone tests

2.1.5. X-ray microanalytical methods

This chapter acquaints the reader with the types of principal instruments that are typically used for the localization of inorganic elements in plant tissue. X-ray microanalytical methods are a powerful technique that allows the determination of many elements of physiological interest at the subcellular level.

X-ray microanalytical methods cover various modern methods. This subchapter includes the following methods:

- Energy dispersive X-ray microanalysis (EDS)
- Electron energy loss spectroscopy (EELS) and imaging (ESI)
- Particle induced X-ray emission (PIXE)
- Synchrotron-based X-ray fluorescence and absorption-edge microtomography (F-CMT, AE-CMT)
- Synchrotron X-ray fluorescence (μ -SXRF) mapping and X-ray absorption fine structure (XAFS) spectroscopy.

2.1.5.1. Energy dispersive X-ray microanalysis (EDS)

Brief method description

The basic principle of EDS in a scanning electron microscope is that the electron beam scanned across the specimen area of interest excites atoms to emit X-ray photons which are collected by a semiconductor crystal. The energy of the X-ray photon hitting the crystal is converted into a voltage pulse proportional to the energy of the X-ray photon. The voltage pulses are sorted by a multichannel analyzer, thus forming the X-ray spectrum. EDS-detectors allow the measurement of all elements of $Z \geq 5$ (B) simultaneously. For a review consult one of the standard references below.

Basic references

Frey, B.; Scheidegger, C. 2002. Preparative techniques for LTSEM of lichens. In *Methods in lichenology*, Eds. I. Kranner, R.P.Beckett and A. Varma. Springer Lab Manual, Heidelberg 118-132.

Frey, B.; Zierold, K. 2003. X-ray microanalysis in botanical research. In: *Science, Technology and Education of Microscopy: an overview*, ed. A. Mendez-Vilas. Formatex, Extremadura, p. 313-324.

Marshall, A.T. 1988. X-ray microanalysis of frozen-hydrated biological bulk samples. *Mikrochim. Acta Suppl.* 15 (1998), pp. 273-282

Sigee, D.C. 1998. Environmental SEM and X-ray microanalysis of biological materials. *Mikrochim. Acta Suppl.* 15, pp. 283-293.

Zierold, K. 2002. Limitations and prospects of biological electron probe X-ray microanalysis. *J. Trace Microprob. Tech.* Vol. 20, pp. 181-196.

Application areas

EDS techniques have a broad application for various types of localizations of relevance to plant physiology, environmental pollution and root-microbe interactions. The principal field of interest is related to determining the distribution of water-soluble ions or to determining the identity and occurrence of inorganic deposits in cells such as silicon in cell walls or calcium in plant vacuoles as calcium-oxalate crystals. An interesting range of applications in physiological studies covers investigations on the uptake and transport of inorganic ions in plants using apoplastic (La) or symplastic (Rb, Cs) as tracers. A particularly successful field for EDS was the study of metal detoxification. The knowledge of the localization, distribution and quantification of toxic elements in root organs and cell compartments indicates possible pathways of transport and mechanisms of detoxification and is therefore important in reaching an understanding of tolerance mechanisms of heavy metals in plant sciences.

Problems, constraints, do's and don'ts

Reliable quantitative EDS measurements of biological specimens require special preparation techniques. Rapid freezing methods are suitable in preserving native-state cell structure, as well as having the least detrimental effect on redistribution and translocation of elements. Such frozen botanical specimen has to be opened by fracturing or by cryosectioning in order to image and analyze the inner part. Cryofractures can

be directly analyzed in the cryo-SEM. However, the freeze-fracture method of preparing botanical specimens has not previously produced good results in studies on element distribution at the sub-cellular level. A resolution limit of about 2 µm is indicated for frozen-hydrated samples. This rather poor spatial analytical resolution is improved considerably in thin specimens such as cryosections, approximately 100 nm thick

Related method sheet

ID	21_Frey
Parameter	elemental analysis of root and mycorrhiza tissue
Soil type	forest soil
Plant species	spruce, beech
System	field and laboratory material (rhizoboxes, in vitro cultures)
Method	energy dispersive X-ray microanalysis (EDS)

2.1.5.2. Electron energy loss spectroscopy (EELS) and imaging (ESI) – microanalytical method

Brief method description

The distribution of elements in biological specimens on the cellular and subcellular level can be determined by electron energy loss spectroscopy (EELS) and electron spectroscopy imaging (ESI) which is a technique exploiting the interactions of the electron beam with the inner shell electrons of distinctive elements ($Z = 3-92$) and is an extension of the capabilities of a transmission electron microscope (TEM). Root samples collected from the field or from rhizoboxes or pots have to be fixed, dehydrated and embedded in resins. Ultra thin sections supported on grids are observed in TEM and the area for element analysis is selected. Element distribution maps can be obtained that should be supported by the spectra in the chosen areas.

Basic references

Kottke, I. 1994. Localization and identification of elements in mycorrhizas. Advantages and limits of electron energy-loss spectroscopy. *Acta Bot Gallica* 141:507-510.

Egerton, RF. 1996. Electron energy loss spectroscopy in the electron microscope. New York: Plenum.

Williams, D.B.; Carter, C.B. 1996. Transmission Electron Microscopy. A textbook for materials science. New York and London: Plenum Press, pp 729.

Turnau, K.; Kottke, I. 2005. Fungal activity as determined by micro-scale methods with special emphasis on interactions with heavy metals. In: *The Fungal Community*. J. Dighton, J.F. White, P.Oudemans (eds.), CRC Press, Boca Ration pp. 287-306.

Orlovich, D.A.; Ashford, A.E. 1995. X-ray microanalysis of ion distribution in frozen salt/dextran droplets after freeze-substitution and embedding in anhydrous conditions. *J. Microsc.-Oxford* 180:117-126.

Application areas

The method is primarily used to study interactions between plants, fungi and bacteria within the mycorrhizosphere. Several studies were carried out to assess the role of fungi in heavy metal detoxification using field material. The studies carried out on laboratory systems (rhizoboxes or in vitro cultures) are mostly unexplored, although there are possibilities to study even long-distance transport (using La and Ce as markers). In addition, parallel histochemical studies may help to understand the nature of substances involved in element accumulation. The method can be also used to study plant reaction to pathogenic fungi in the rhizosphere.

Problems, constraints, do's and don'ts

Sample preparation is a critical point of using micro-analytical tools on biological material. The material should be properly cleaned and washed in ice cooled water and fixed as soon as possible. Drying/rehydrating and freezing/thawing of soil samples containing fungal hyphae might result in large decrease of metal concentration in the hyphae. Artifacts resulting from faulty preparation are possible to recognize by transmission electron microscopy. The strongest changes occur in senescent and dead cells. Distinguishing between fixation-induced and natural changes usually requires experience. Methods

accompanying the microanalytical tools, such as observation with light microscope accompanied by Nomarski contrast or physiological studies, are vital to avoid misinterpretations. The most adequate protocol to study element distribution seems to be the anhydrous freeze-substitution method (Orlovich and Ashford, 1995).

Related method sheet

ID	21_Turnau_a
Parameter	element localization and distribution in plant material
Soil type	natural soils and industrial wastes
Plant species	broad range of plants including ferns, liverworts, angio and gymnosperms
System	field and laboratory material (rhizoboxes, <i>in vitro</i> cultures)
Method	electron energy loss spectroscopy (EELS) and imaging (ESI)

2.1.5.3. Particle induced X-ray emission (PIXE) – a microanalytical method

Brief method description

The distribution of elements in biological specimens at the cellular and subcellular level may be determined by the use of focused protons, instead of electrons, for the generation of characteristic X-rays. This technique is referred to as PIXE (particle induced X-ray emission). Detection of characteristic X-rays generated during the interaction of protons with distinctive elements (elemental range from Na to U) in a specimen is an extension of the capabilities of a scanning electron microscope (SEM). Quantitative PIXE analysis is a sensitive technique (concentrations down to ppm can be analysed) and benefits from the possibility of simultaneous use of proton backscattering (BS) or scanning transmission ion microscopy (STIM) techniques for matrix corrections and the analysis of lighter elements (C, N, O).

Basic references

Johansson, S.A.E.; Campbell, J.L.; Malmqvist, K.G. 1995. Particle Induced X-ray Emission spectrometry (PIXE). New York: John Wiley & Sons.

Mesjasz-Przybylowicz, J. 2001. The nuclear microprobe – a challenging tool in plant sciences. *Acta Phys Pol A* 100 (5):659-668.

Mesjasz-Przybylowicz, J; Przybylowicz, W.J. 2002. Micro-PIXE in plant sciences: Present status and perspectives. *Nucl. Instr. Meth. in Physics Res. B* 189: 470-481.

Turnau, K.; Kottke, I. 2005. Fungal activity as determined by micro-scale methods with special emphasis on interactions with heavy metals. In: *The Fungal Community*. J. Dighton, J.F. White, P.Oudemans (eds.), CRC Press, Boca Ration pp. 287-306.

Application areas

The method was used to study heavy metal distribution in the mycorrhizosphere and differences in metal sequestration within mycorrhizas of different morphotypes, to determine the localization of a broad range of elements including Cl, As, Pb, S, P, Cd, Zn in arbuscular mycorrhizas (AM) and in AM mycelium collected from substratum enriched with Cd or from industrial wastes. It elegantly demonstrates element precipitation at the surface of soil mycelium and in the rhizosphere, being also very useful to study the transformation of minerals by fungi, bacteria and plants. It can potentially be applied in studies on nutrition, interactions between elements in the rhizosphere, transport, sequestration and functions of minor and trace elements. Scanned areas are usually 2.5 mm x 2.5 mm in the case of general maps of the whole sections. They might be complemented by analyses of smaller regions of particular interest of any sizes down to the beam spot size (1 um). The possibility of quantitative, precise maps of comparatively large area is the main advantage of the PIXE method over EDX and EELS; however, the higher magnifications obtained with the last two techniques are not available with PIXE, making studies at the ultrastructural level impossible.

Problems, constraints, do's and don'ts

Specimen sampling and preparation are the critical steps in elemental microanalysis. Cryotechnique is the best option among available preparation techniques. Good results in analysis of various types of mycorrhiza were obtained

while the samples were rapidly frozen by plunging them into liquid cryogen (propane, isopentane) cooled by liquid nitrogen and subsequently freeze-dried. Cryosectioning is the most difficult part of the specimen preparation protocol, because of sample heterogeneity. Chemical fixation and embedding of samples should be avoided due to element redistribution and washing out. Quantitative, two dimensional PIXE (particle induced x-ray emission) maps of elemental distribution are obtained.

Related method sheet:

ID	21_Turnau_b
Parameter	distribution and quantitative analysis of elements in plant material
Soil type	natural soils and industrial wastes
Plant species	broad range of plants including ferns, liverworts, angio- and gymnosperms
System	field and laboratory material (rhizoboxes, in vitro cultures)
Method	Particle induced X-ray emission (PIXE)

2.1.5.4. Synchrotron-based X-ray methods

Brief method description

Synchrotron X-ray fluorescence (SXRF) spectroscopy provides *in situ*, highly sensitive, and well-resolved 2D elemental maps and, when coupled with X-ray absorption fine structure spectroscopy (XAFS) is able to determine the elemental speciation. Synchrotron-based X-ray absorption-edge and fluorescence CMT are imaging techniques that utilize a high-intensity, tunable X-ray beam to nondestructively interrogate a sample as it is translated and/or rotated within the beam. The result, after computational reconstruction, is the cross-sectional two- and three-dimensional distributions of specific elements within the sample. Unlike conventional X-ray CMT instruments, synchrotron-based fluorescence CMT can provide a highly resolved picture of the multi-elemental distribution through a virtual slice of the sample at concentrations down to approximately 100 $\mu\text{g g}^{-1}$ (element dependent). Absorption-edge CMT

provides a fully 3D image of the metal distribution, albeit, with some loss of sensitivity.

Basic references

Hansel, C. M.; Fendorf, S. 2001. Characterization of Fe plaque and associated metals on the roots of mine-waste impacted aquatic plants. *Environ. Sci. Technol.* 35: 3863-3868.

Hansel, C. M.; LaForce, M. J.; Fendorf, S.; Sutton, S. 2002. Spatial and temporal association of As and Fe species on aquatic plant roots. *Environ. Sci. Technol.* 36: 1988-1994.

Howe, J. A.; Loeppert, R. H.; Derose, V. J.; Hunter, D. B.; Bertsch, P. M. 2003. Localization and speciation of chromium in subterranean clover using XRF, XANES, and EPR spectroscopy. *Environ. Sci. Technol.* 37: 4091-4097.

Keon-Blute, N.; Brabander, D. J.; Hemond, H. F.; Sutton, S. R.; Newville, M.; Rivers, M. 2004. Arsenic sequestration by ferric iron plaque on cattail roots. *Environ. Sci. Technol.* 38: 6074-6077.

McNear, D.; Peltier, E.; Everhart, J.; Chaney, R.L.; Sutton, S.; Newville, M.; Rivers, M.; Sparks, D.L. 2005. Application of quantitative fluorescence and absorption-edge computed microtomography to image metal compartmentalization in *Alyssum murale*. *Environ. Sci. Technol.* 39: 2210 - 2218;

Pickering, I. J.; Prince, R. C.; Salt, D. E.; George, G. N. 2000. Quantitative, chemically specific imaging of selenium transformation in plants. *Proc. Natl. Acad. Sci. U.S.A.* 97: 10717-10722.

Scheckel, K. G.; Lombi, E.; Rock, S. A.; McLaughlin, N. J. 2004. In vivo synchrotron study of thallium speciation and compartmentation in *Iberis intermedia*. *Environ. Sci. Technol.* 38: 5095-5100.

Application areas

The XAFS microprobe (SXRF, XAFS, XRD) provides a nondestructive suite of spectromicroscopic techniques useful for the investigation of molecular speciation, complexation, oxidation state, as well as spatial distribution and associations of elements.

Application of these techniques has included imaging of various phenomena in earth and material sciences. For example, absorption-edge CMT was used to explore the association between cation sorption sites in soils, and Fe and pore-space distributions. There are some applications of synchrotron tomographic techniques to biological systems (e.g. roots), where fluorescence CMT was used to help characterize Fe plaques and associated

metals on the surface of roots from the aquatic plants *Phalaris arundinacea* and *Typha latifolia*. It was shown that Pb and Fe accumulated on the surface of the root in a juxtaposed pattern, forming a rind on the root surface while As was isolated to distinct regions on the exterior and interior of the root. Similarly, fluorescence CMT was used to reveal that As was sequestered by Fe(III) oxyhydroxides within cattail root plaques from a contaminated wetland.

ID	21_Tappero
Parameter	(In-situ) Elemental distributions, associations, and molecular speciation in plant material
Plant species	Techniques applicable to plant tissue with element concentration exceeding ~100 mg/g D.W.
System	Material from field and laboratory systems
Method	Synchrotron X-ray fluorescence (μ-SXRF) mapping and X-ray absorption fine structure (XAFS) spectroscopy

Problems, constraints, do's and don'ts

However, because SXRF is 2D and the beam penetrates into or through the sample, the resulting SXRF image is actually a projection showing all of the entrained elements from one specific direction. Therefore, it may be difficult to tell exactly which compartment or specific tissue contains an observed element-specific-rich region. For instance, a face-on view of a root will show elements on both surfaces as well as those in the interior. Thus, a metal could be entrained on one side as well as on the other side of a root tissue, which would appear associated in the SXRF image but are instead separated by the thickness of the root. Therefore, because of these "thickness" effects, determining the compartmentalization of metals using SXRF should be done with caution and if possible, verified using another technique.

Related method sheets

ID	21_McNear
Parameter	Quantitative Elemental Compartmentalization in Plant tissues
Plant species	Any plant tissue with elemental concentrations exceeding $\sim 100 \mu\text{g g}^{-1}$ DW
System	material from field or laboratory systems
Method	Synchrotron based X-ray fluorescence and absorption edge computed microtomography (F-CMT and AE-CMT)

Editor: Jaillard, Benoît

Institut National de Recherche Agronomique, 2, Place Pierre Viala, F-34060
Montpellier

benoit.jaillard@ensam.inra.fr ; ++33 4 99 61 23 82

2.2.1. Introduction

The rhizosphere is by definition the volume of soil close to roots. This soil volume is exposed to various actions exerted by roots and associated microorganisms which induce some solid phase transformations. The rhizosphere is thus a part of soil characterized by its location around the plant roots. Consequently, the methods for analyzing the rhizosphere properties are almost not different from the methods usually used for analyzing the bulk soil properties. This chapter covers classical and modern soil chemical methods. Most of them are described in reference books as the one of Sparks (1996). Many of them are of interest to rhizosphere studies. However, most of these methods can be applied to rhizosphere soil only if it has been first separated from bulk soil by one of the sampling methods covered in **chapter 1.3**. The only methods which allow a direct measurement, without separating step, are microanalytical methods. These methods are generally based on the use of electromagnetic radiation, such as electronic microanalysis or more recent X-ray spectroscopy. The access to the rhizosphere volume is then allowed by specific preparation of samples, such as embedding and cutting or polishing, in order to clear the areas of interest. The methods covered in this chapter are as follows :

- Elemental analysis, mineralogical analysis and speciation of the soil solid phase by sequential extractions
- speciation of solid phases by X-ray spectroscopy
- acidity and exchangeability of soils

- evaluation of availability of elements in soils
- isotopic exchange with soils
- biotest for ecotoxicological determinations

Basic reference:

Sparks, D.L. (ed.). 1996. Methods of Soil Analysis; Part 3, Chemical Methods. Soil Science Society of America Book Series No. 5, Soil Science Society of America, Madison WI, 1390 pp.

2.2.2. Elemental and mineralogical analysis of soils

Brief method description

A basic description of a soil sample consists at first of its elemental composition and the mineralogical nature of its constitutive solid phases. The composition in terms of total element contents can be measured after dissolving the whole solid phase in strong acidic solutions followed by analysis with atomic spectrometry (atomic absorption spectrometry, inductively-coupled plasma optical emission or mass spectrometry). However, the manipulation of strong acids is always risky for the security as well as for the environment. So this method is today replaced as it is possible by physical methods as X-ray fluorescence spectrometry of fusions or powder samples (**22_Zimmermann_a**). Similarly, the X-ray diffractometry makes it possible to identify the mineralogical nature of constitutive solid particles.

The total elemental contents of a soil may be of limited interest. Some fractions of soils such as fractions resulting from

pedogenetic processes or fractions available for plants or microorganisms are of greater interest for researchers (see also **Chapter 2.2.5.**). These sub-fractions have been generally defined by a specific extraction procedure. There are numerous extractions and related analytical methods described in the literature to define different pools of nutrient elements, heavy metals, oxides etc. It is beyond the scope of this handbook to describe these methods in detail. For an overview it is referred to the standard reference above. Specific methods used by researchers with interest in the rhizosphere can be found in the method sheets below.

Application areas

Most of these methods have been developed originally for agricultural soils. However, very acid or alkaline soils for instance have some specificities which have led researchers to improve and adapt the methods for each type of soils. To distinguish between the basic soil types, acidic, neutral, calcareous and saline in particular, is henceforth essential for numerous parameters. Many of the methods have been applied also to forest soils. In the latter case, some methods require special attention and measures if organic matter content of the soil is high.

Problems, constraints, do's and don'ts

The soil extraction methods are operationally defined, i.e. the results do not reflect a certain chemically defined fraction but depend on operating conditions such as strength of the extractant, temperature, time, etc. This means that the protocols have to be followed strictly for that the results obtained for different samples can be compared to each other. With respect to rhizosphere soil, small amounts of sample can be a problem for extraction.

Specific contribution to rhizosphere research

None of these methods have been developed specifically for rhizosphere related questions. However, virtually all of

them can be applied to rhizosphere soil that has been separated from bulk soil by a suitable method (**chapter 1.3.**).

Related method sheets

ID	22_Luster_b
Parameter	Reactive and Soluble Trace Elements in Soils
Soil type	Acid and calcareous soils
Method	buffered EDTA extraction; water extraction

ID	22_Nowack
Parameter	Solid phase speciation of heavy metals
Soil type	all soil types
System	homogenized soil samples
Method	Sequential extraction (Zeien and Brümmer)

ID	22_Turpault
Parameter	Quantitative mineralogy of rhizosphere soil
Soil type	Acid forest soils
Plant species	A mono-species stand of any forest species
System	Field soil
Method	Multistep procedure performed on particle size fractions

ID	22_Zimmermann_a
Parameter	Total and total extractable element contents in soil
Soil type	Acid and calcareous forest soils
Method	XRF of powder and fused discs; HNO₃ extracts

ID	22_Zimmermann_b
Parameter	Pedogenic oxides
Soil type	Acid and calcareous forest soils
Method	Total Fe oxides by dithionite/citrate extraction; amorphous Fe and Al oxides by oxalate extraction; organically bound Fe and Al by pyrophosphate extraction

2.2.3. Speciation of solid phases by X-ray spectroscopy

Brief method description

The rhizosphere can be observed directly using microscopic methods. These methods experienced a significant development in the 1970's with electronic microscopy (e.g. Foster et al., 1983). Since, electronic microscopy continued to diversify with high resolution imaging, elemental mapping (scanning transmission

electron microscopy STEM, energy filtering), and the spectroscopic techniques (energy loss of electrons) now available on the majority of the microscopes. The nanometer resolution of X-rays and electrons gives a crucial advantage in the study of the rhizosphere processes because these processes are localised on the level of the cells and the interfaces between living organisms and soil (Manceau et al., 2002). Because they are still new and not very accessible, it is likely that these methods will contribute in the next years to a better description and understanding of the soil transformations which occur in the rhizosphere.

Basic references

Foster, R.C.; Rovira, A.D.; Cock, T.W. 1983. Ultrastructure of the Root-Soil interface. St. Paul, Minn., U.S.A., American Phytopathological Society.

Manceau, A.; Marcus, M.A.; Tamura N. 2002. Quantitative speciation of heavy metals in soils and sediments by synchrotron X-ray techniques. In: Fenter, P.; Rivers, M.; Sturchio, N.C.; Sutton, S. (eds.). Applications of Synchrotron Radiation in Low-Temperature Geochemistry and Environmental Science. Reviews in Mineralogy and Geochemistry, Mineralogical Society of America, Washington, DC., vol. 49: 341-428.

Application areas

The spectroscopic methods are well adapted to the study of mineral or organic solid phases. They make it possible to study the nature of binding between the different elements constitutive of the solid phases studied. Then these methods make it possible to identify and analyze some mineralogical or organic transformations which occur in rhizosphere.

Problems, constraints, do's and don'ts

The spectrometric methods use electromagnetic radiation, what implies to have access to the phases for studying. So, the methods are generally used on soil surfaces to access easily different compartments in soil or rhizosphere. The soil surfaces analyzed can result from embedding with resin followed by cutting.

It is however also possible to design specific devices such as rhizotrons where the soil-root interface is forced to be planar. Another constraint results today from the limited accessibility to instrument facilities.

Specific contribution to rhizosphere research

These methods are new and the main domains of application are physics and material sciences. However, some studies show the potential ability of these techniques for determining composition of interfaces such as cell walls of roots or of fine structure in soils close to the roots.

Related method sheets

ID	22_Manceau
Parameter	Molecular speciation of trace metals in solid phases, and elemental associations at the micrometer scale
Soil type	Techniques applicable to all solid matrices
System	Field soil, microcosms
Method	Synchrotron-based X-ray microfluorescence (SXRF), microdiffraction (micro-XRD), and extended X-ray absorption fine structure (EXAFS) spectroscopy

ID	22_Tappero
Parameter	(In situ) Elemental distributions, associations, and molecular speciation in solid phases
Soil type	e.g. enriched natural soils and industrial wastes
System	Techniques applicable to solid matrices
Method	Synchrotron X-ray fluorescence (μ-SXRF) imaging and X-ray absorption fine structure (XAFS) spectroscopy

2.2.4. Acidity and exchangeability of soil samples

Brief method description

The main chemical parameter of a soil is its pH. This parameter characterises the soil's ability to release protons in solution. It is thus an indicator of the soil acidity. However, the soil pH depends greatly of the measurement conditions, that have led

researchers to define various "standard" conditions for pH measurements. That is the nature of extraction solution, pure water, KCl or CaCl₂ solutions, or cobalthexamine solution, each method giving a specific information about the acidity of the soil. That is also the soil : solution dilution ratio and the procedure for shaking the suspension.

In fact, soil pH, soil buffering for protons, and soil acidity are strongly related. Moreover, all these parameters are in close relation with the exchange capacity of soil and the elemental composition of the exchange complex of the soils. The methods set up to measure these parameters are generally based on an extraction with a solution of a given composition, followed by a measurement of pH in solution and the analysis of elements removed from soil by the extraction solution.

Application areas

These methods are really important in the rhizosphere domain because they concern the main soil parameters which are consequently the first modified by the activities of roots and microorganisms: pH, acidity, composition of soil exchange complex.

Problems, constraints, do's and don'ts

Most of these methods have been developed originally for soil samples available in large quantity. The main problem raised with respect to the rhizosphere consists in the limited amount of sample available. This difficulty has been often bypassed in using experimental devices which make it possible to collect more soil considered as rhizosphere soil (see **chapters 1.1 and 1.3.**). However, few data have been obtained until now from the field.

Specific contribution to rhizosphere research

None of these methods have been developed specifically for rhizosphere related questions. However, virtually all of

them can be applied to rhizosphere soil that has been separated from bulk soil by a suitable method (**chapter 1.3.**).

Related Method Sheets

ID	22_Calba
Parameter	pH, CEC, and exchangeable cations in soil
Soil type	Any soil
Method	cobalthexamine chloride extraction

ID	22_Luster_a
Parameter	Soil acidity; soil cation exchange capacity (CEC), base saturation, and BC/Al ratio
Soil type	Acid and calcareous soils
Method	Soil pH using water or CaCl₂ extracts; exchangeable acidity by KCl extraction; exchangeable cations by NH₄Cl extraction

ID	22_Sas-Paszt
Parameter	Soil pH; available contents of P, K, Mg and microelements
Soil type	Mineral soil from pomological orchards
Plant species	Strawberry, apple, pear
System	Soil from laboratory or field
Method	soil extracts: KCl (pH); lactate buffer (P, K); CaCl₂ (Mg); HCl (microelements)

2.2.5. Evaluation of the availability of elements in soils

Brief method description

The roots take up from the soil solution all the mineral elements that the plants need. The soil solution is thus a compartment which merits to be characterized carefully. However, the composition of soil solution results from exchanges with solid phases of soil. We have previously noted that exchangeable cations of soil can be removed by different solutes in solution. Nutrients such as phosphorus or nitrogen, as well as trace elements can also be dissolved in the soil solution. The methods presented here make it possible to specify the chemical forms under which these elements occur in the soil and their tendency to become dissolved in soil solution. They consist of simple extractions with different specific solutions, the composition of which have been chosen to mimic actions supposedly exerted by roots. The extracted solutions

are then analysed with specific apparatus to determine phosphorus, nitrogen or carbon concentrations, etc... (see **Chapter 2.3.**).

Application areas (major, minor, potential, limitations)

The rhizosphere is the soil volume where roots take up mineral elements from soil; these methods are thus of special interest to characterise the mineral exchange between soil and plants. They often are a practical alternative to the in-situ sampling of rhizosphere soil solution which is a very difficult task (see **Chapter 1.3.**)!

Problems, constraints, do's and don'ts

The quantity of matter dissolved in soil solution or in respective extracts can be very small, in which case the problem arising from the small extension of the rhizosphere is difficult to solve. Then the methods described here can be used only if we are able to collect soil samples large enough, or alternative microanalytical methods are used for analysing the extracts.

Specific contribution to rhizosphere research

Many studies concerning the rhizosphere dynamics and bioavailability of mineral elements for plants are based on studies using the methods presented in this paragraph. In general matter, the evaluation of bioavailability of elements for crops is a question of first importance for the prediction of yield and the management of fertilisation. As a consequence, there is a large variety of methods available, many authors having developed their own method supposedly better than previous existing methods.

Related Method Sheets

ID	22_Friedel_a
Parameter	Soil ammonium and nitrate
Soil type	agricultural soils
Method	Photometric determination in soil extracts

ID	22_Friedel_b
Parameter	Soil microbial biomass C and N in the rhizosphere
Soil type	Agricultural soils
Method	Dissolved organic C and N determination in 0.5 M K₂SO₄ soil extract

ID	22_Luster_b
Parameter	Reactive and Soluble Trace Elements in Soils
Soil type	Acid and calcareous soils
Method	buffered EDTA extraction; water extraction

ID	22_Luster_c
Parameter	Soil nutrient status
Soil type	Acid and calcareous soils
Method	Exchangeable cations by NH₄Cl extraction; P fractionation; Total C and N, inorganic C

ID	22_Sas-Paszt
Parameter	Soil pH; available contents of P, K, Mg and microelements
Soil type	Mineral soil from pomological orchards
Plant species	Strawberry, apple, pear
System	Soil from laboratory or field
Method	soil extracts: KCl (pH); lactate buffer (P, K); CaCl₂ (Mg); HCl (microelements)

2.2.6. Isotopic exchange with soils

Brief method description

Different isotopes of the same element have the advantage to be physically different but chemically the same. The method of isotopic dilution is based on the hypothesis that, in a given soil, the isotopic composition of different soil compartments in equilibrium is constant. The method consists of adding of a little amount of a given isotope in the soil solution, and of following the change in its concentration in solution until equilibrium. The amount of element isotopically exchanged from the soil is defined as the E-value (E for "exchangeable"). This amount is generally compared to the amount of the same element which can be accumulated into

the plant in the same conditions : this last amount is defined as the L-value (L for Larsen, 1952) of the soil-plant system. The use of radioactive isotopes makes it possible to change very slightly the isotopic composition of the soil sample and to be able to follow easily the kinetics of composition change in the soil solution (Fardeau, 1996).

References

Larsen, S. 1952. The use of ^{32}P in studies on the uptake of phosphorus by plants. *Plant and Soil* 4: 1-10.

Review on the use of isotopes for soil P dynamics: Fardeau, J.C. 1996. *Fertilizer Res.* 45: 91-100.

Application areas

Radioactive isotopes are specially well suited in the case of elements that are difficult to measure otherwise or because the concentration of the element is small (trace elements).

Problems, constraints, do's and don'ts

The main limitation of isotopic methods results from their principle: the method measures an equilibrium between solid phase and solution, without considering any external actions. However, the rhizosphere is specifically the place where roots, microorganisms and soil interact. Therefore it cannot be considered as being at equilibrium. The isotopic methods are consequently well adapted to characterize bioavailability when the actions exerted by roots and associated microorganisms can be neglected.

Related method sheets

ID	22_Mollier
Parameter	Dynamic of the diffusive soil (ortho)phosphate
Soil type	Any materials: agricultural soils, fluvial sediments and suspended sediments, sewage sludge,...
System	Batch experiments on soil suspensions at steady state
Method	Sorption and $^{32}\text{PO}_4$ labeling and dilution kinetics

ID	22_Sinaj_a
Parameter	Bioavailability of P, Zn and Cd
Soil type	Temperate and tropical soils
System	Batch experiments with soil:water suspension
Method	Isotopic Exchange Kinetics (IEK; E-value)

ID	22_Sinaj_b
Parameter	Bioavailability of P, Zn and Cd
Soil type	Temperate and tropical soils
Plant species	Any
System	Pot / rhizobox experiments with plants grown in labeled soils
Method	Uptake of elements from radioactively labeled soils (L-values)

2.2.7. Biotest for ecotoxicological determination

Brief method description

The last method presented in this chapter consists of a biological test which allows to evaluate the activities of toxic elements in solution. These methods are well developed in the domain of aquatic ecosystems. Although not widely used yet, they seem promising for direct applications to soil. The only method presented here should therefore be considered as a pioneer method.

Related method sheet

ID	22_Boularbah
Parameter	Inhibition of the b-galactosidase activity in a mutant strain of <i>Escherichia coli</i>, by bioavailable heavy metals
Soil type	Agricultural, urban or industrial soils
Plant species	No specification
System	Soils sampled from agricultural, urban or industrial soils
Method	MetPLATE: A direct solid-phase assay for rapid assessment of heavy metal bioavailability to plants

Editor: Nowack, Bernd

EMPA – Materials Science and Technology, Lerchenfeldstrasse 5, CH-9014
St. Gallen, Switzerland

*nowack@empa.ch; ++41 71 274 76

2.3.1. Introduction

This chapter deals with the analysis of soil solution and in particular rhizosphere soil solution. The difference between the two is that rhizosphere soil solution is normally restricted in volume to a few mL or less. Its collection is dealt with in **chapter 1.3**. The basic analytical methods described in this chapter are standard methods used for water and soil solution analysis and are well documented in the literature and in national and international standard methods. For further reading regarding the basic methods the reader is referred to standard textbooks on analysis:

Standard Methods for the Examination of Water and Wastewater. 17th Edition, 1989, American Public Health Association, Washington, DC.

Wolt, J. 1994. Soil solution chemistry: Applications to environmental science and agriculture. John Wiley and Sons, New York.

Sparks, D.L. (ed.). 1996. Methods of Soil Analysis, Part 3: Chemical Methods. SSSA Book Series: 5: SSSA, ASA, Madison, WI.

In particular, this chapter presents methods how to measure

- pH
- Total concentrations of elements and inorganic ions
- Sum parameters for dissolved organic carbon, nitrogen and phosphorus. The analysis of individual organic substances is covered in **chapter 3.1**.

This chapter also presents some speciation methods that have been applied to soil solution. The total concentration of an element is often only of limited significance regarding the bioavailability of the compound and information on its speciation is needed.

2.3.2. Solution pH

Brief method description:

This section discusses both the standard way to measure soil solution pH in sampled soil solution as well as more rhizosphere-specific methods.

Usually the pH is measured with a normal pH-electrode when enough solution (few ml) is available. For an in-depth discussion see Galster (1991). If only small amounts of solution are available then either very small micro-glass electrodes that only need a few hundred μ l sample volume or ISFET (ion-selective field effect transistor)-sensors can be used (**23_Goettlein_a**, **23_Nourrisson**). The pH can also be directly measured in the soil using small electrodes. Especially in conjunction with rhizobox techniques the direct measurement can give pH profiles with a high spatial resolution (**23_Puschenreiter_a**).

Rhizosphere-specific methods for pH measurements have also been developed. The efflux of H^+ from roots can be measured using the pH-stat technique in hydroponic solution (**23_Hinsinger_a**). Addition of base or acid keeps the pH in the solution constant and thus allows quantifying the proton efflux from roots. Microelectrodes can also be used to quantify proton efflux / influx from roots (**23_Plassard**). The use of agar with incorporated pH-indicator as growth medium can allow the visualization of pH changes in the rhizosphere. This can be done in a qualitative way (**23_Loes**) but it is also possible to get quantitative information by mapping the color with a

CCD camera and using image analysis to convert color into pH values (**23_Hinsinger_b**).

Basic references

Galster, H. 1991. pH Measurements. Verlag Chemie, Weinheim.

Application areas

Standard methods with electrodes can be applied to all (rhizosphere) soil solutions. The rhizosphere-specific methods may be useful for some specific laboratory-based investigations.

Problems, constraints, do's and don'ts

The main problem will be the small sample volume of rhizosphere solution samples. However, special microelectrodes allow pH-measurements in a few 100 µl of solution. The calibration of the pH-sensor with calibration buffers is the central point when using pH electrodes. For ISFET for example, the ionic strength of the calibration buffers and the samples should be comparable what requires that commercially available calibration buffers be diluted. The direct insertion of micro-pH electrodes into the soil is possible but has not been used to a great extent. However, a stable water content is a prerequisite for a stable pH measurement.

Specific contribution to rhizosphere research

Especially the agar-method has been very important to visualize the influence of growing roots on the pH in the surrounding medium. The direct insertion of pH-electrodes into the rhizosphere may allow pH-measurements with very high spatial resolution and may be very useful for laboratory-based studies.

Related method sheets

ID	23_Goettlein_a
Parameter	pH, concentration of major cations and anions in soil solutions
Soil type	Acid forest soils
Plant species	Oak, beech, spruce
System	Rhizotrones, root windows
Method	Capillary Electrophoresis (CE) and ISFET pH-sensor

ID	23_Graf_Pannatier
Parameter	Inorganic Composition of Forest Soil Solutions (incl. sum parameters for organic C and N)
Soil type	Acid and calcareous forest soils
System	Field and Model Ecosystems
Method	Analysis of pH, electrical conductivity, inorganic anions, total element concentrations (nutrients, aluminum, trace metals), inorganic and organic carbon

ID	23_Hinsinger_a
Parameter	Proton efflux/influx from roots grown in hydroponics
Soil type	No soil – nutrient solution (might include solid suspension) only
Plant species	Any possible species
System	Growth chamber or glasshouse experiments in nutrient solution tanks
Method	pHstat – determination of proton fluxes at constant pH

ID	23_Hinsinger_b
Parameter	Proton efflux / influx from roots grown in agarose gels
Soil type	No soil – transparent medium required (agarose gel)
Plant species	Any possible species, split root system possible for larger plants
System	lab microcosm
Method	Videodensitometry of dye-indicator/agarose gel

ID	23_Loes
Parameter	Rhizosphere pH
Soil type	Agar with nutrient solution
Plant species	Wheat and barley
System	Petri dish
Method	Visualisation of changes in rhizosphere pH in dye-indicator/agarose gel

ID	23_Nourrisson
Parameter	Total element (Al, Si, Ca, Fe, K, Mg, Mn, TOC) and ion (NH₄⁺, NO₃⁻, Cl⁻, F⁻, SO₄²⁻, PO₄²⁻) concentrations, pH in soil solution
Soil type	acid forest soil
Plant species	All forested species
System	Soil solutions obtained by micro-suction cups in field soil or in microcosm
Method	A chain of analyses adapted to volumes of < 2ml

ID	23_Plassard
Parameter	Ion efflux / influx from roots grown in hydroponics
Soil type	No soil – nutrient solution only
Plant species	Any species of reasonable size
System	Growth chamber or glasshouse experiments in nutrient solution tanks
Method	Ion-selective microelectrodes

ID	23_Puschenreiter_a
Parameter	pH and redox potential in rhizosphere soil solution
Soil type	any
Plant species	any
System	Rhizobox
Method	Online measurement with pH and redox electrodes

2.3.3. Total concentrations of elements and ions

Brief method description

Standard methods, e.g. ion-chromatography (IC), liquid chromatography (HPLC), inductively coupled plasma mass spectrometry (ICP-MS), inductively coupled plasma optical emission spectrometry (ICP-OES), atomic absorption spectrometry (AAS), photometry, and flow injection analysis (FIA) can be used to determine the total element or ion concentrations when enough sample volume is available. These methods are well established and a large amount of literature and standard methods are available. The reader is referred to these compilations (e.g. Standard Methods for Water and Wastewater Analysis).

If only small volumes (e.g. < 2 mL) are available then special adaptations of the methods have to be used. However, it is possible to analyze major cations and anions together with trace metals when a

total sample volume of less than 2 mL is available, in optimized cases also with just 100 µl (**23_Goettlein_b, 23_Nourrisson**).

Capillary electrophoresis (CE) is a possible method to analyze major cations and anions in rhizosphere samples because only very small sample volumes are necessary (**23_Goettlein_a**). However, relatively high detection limits can be an issue when low solute concentrations have to be measured. Ion chromatography (IC) can reach low detection limits for major anions and organic acids and more than 10 anions can be analyzed simultaneously. Small glass insets for the sample vials allow measurements with less than 100 µl of available soil solution (**23_Zhao**). Colorimetric analyses (e.g. determination of phosphate or ammonium) can be carried out using an autosampler, which reduces sample volume to less than 500 µl (**23_Nourrisson**).

If trace metals have to be measured together with major anions and cations then ICP-MS is the most suitable option. ICP-MS may allow a dilution of the sample due to the low detection limits for most analytes, which eliminates the problem of the small sample volume. Microinjection techniques e.g. using a high-pressure hydraulic nebulizer, can handle sample volumes of less than 1 mL .

Other methods such as ICP-OES that usually need larger sample volumes can be optimized for very small sample volumes. ICP-OES can be optimized so that 7 elements can be determined with about 400 µl.

Basic References

Standard Methods for the Examination of Water and Wastewater. 17th Edition, 1989, American Public Health Association, Washington, DC.

Weiß, J. 2004. Handbook of Ion Chromatography, 3rd edition, Wiley-VCH, Weinheim.

Skoog, D. A.; Holler, F. J.; Nieman, T. A. 1998. Principles of instrumental analysis, 5th edition, Harcourt Brace Publishers.

Montaser, A. 1998. Inductively coupled plasma mass spectrometry. Wiley-VCH, Weinheim.

Valcarcel, M.; Luque de Castro, M.D. 1987. Flow-injection analysis. Ellis Harwood Ltd., Chichester.

Application areas

The methods can be used for all types of soil solution including rhizosphere soil solution.

Problems, constraints, do's and don'ts

The major problem that may be encountered is the small sample volume when microsuction cups are used to get rhizosphere soil solution samples (**chapter 1.3.**). Most analytical instruments, however, allow modifications of standard methods to reduce the sample volume needed.

Specific contribution to rhizosphere research

These are standard methods that have been widely used in rhizosphere research.

Related method sheets

ID	23_Goettlein_a
Parameter	pH, concentration of major cations and anions in soil solutions
Soil type	Acid forest soils
Plant species	Oak, beech, spruce
System	Rhizotrones, root windows
Method	Capillary Electrophoresis (CE) and ISFET pH-sensor

ID	23_Goettlein_b
Parameter	Metal speciation in micro samples of soil solution
Soil type	Acid forest soils
Plant species	Oak
System	Rhizotrones, root windows
Method	Capillary Electrophoresis (CE) and ICP-OES with microinjection

ID	23_Graf-Pannatier
Parameter	Inorganic Composition of Forest Soil Solutions (incl. sum parameters for organic C and N)
Soil type	Acid and calcareous forest soils
System	Field and Model Ecosystems
Method	Analysis of pH, electrical conductivity, inorganic anions, total element concentrations (nutrients, aluminum, trace metals), inorganic and organic carbon

ID	23_Nourrisson
Parameter	Total element (Al, Si, Ca, Fe, K, Mg, Mn, TOC) and ion (NH₄⁺, NO₃⁻, Cl⁻, F⁻, SO₄²⁻, PO₄²⁻) concentrations, pH in soil solution
Soil type	acid forest soil
Plant species	All forested species
System	Soil solutions obtained by microsuction cups in field soil or in microcosm
Method	A chain of analyses adapted to volumes of < 2ml

ID	23_Puschenreiter_b
Parameter	Trace elements and heavy metals in rhizosphere soil solution
Soil type	any
Plant species	any
System	Rhizobox
Method	Sampling with micro tension lysimeters; Analysis with ICP-MS or GF-AAS

ID	23_Sas-Paszt
Parameter	Macro and micro-element concentrations in soil solution
Soil type	Mineral soil from pomological orchards
Plant species	Strawberry, apple, pear
System	Soil experiments
Method	ICP-OES

ID	23_Zhang_a
Parameter	Total Metal concentrations in soil solution
Soil type	All soil types
System	field soil and microcosm
Method	ICP-MS

ID	23_Zhao
Parameter	Concentration of major inorganic anions and low-molecular-weight organic acids in soil solution
Soil type	any
System	Soil solution, rhizosphere soil solution
Method	Ion chromatography (IC)

2.3.4. Organic compounds (only sum parameters)

Brief method description

This part covers methods for the analysis of some sum parameters for organic compounds of interest to rhizosphere research. It covers dissolved organic carbon, nitrogen and phosphorous. The analysis of specific organic compounds is covered in **chapter 3.1.**

Total inorganic and organic carbon are usually measured using a TOC analyzer. The instruments oxidize the carbon to CO₂ by various ways (e.g. persulfate oxidation, catalytic combustion, use of UV-light) and the detection of CO₂ by infrared or chemiluminescence. Organic carbon is measured in acidified samples to be able to purge the inorganic carbonate from the solution.

The method for inorganic and organic phosphorus relies on a color reaction, i.e. the formation of molybdenum blue (**23_Jones_a**). Organic phosphorus is the difference between inorganic P measured after and before oxidation of organic P with persulfate.

The method for organic nitrogen relies on oxidation of organic nitrogen with persulfate to nitrate and measuring nitrate by an established method (e.g. colorimetry; **23_Jones_b**). Automatic total nitrogen analyzers (e.g. coupled to a DOC analyzer) allow the determination of the total nitrogen content. Subtraction of the separately analyzed ammonium and nitrate concentrations allows determining the organic nitrogen content (DON).

These methods are standard methods used in water analysis (e.g. Standard Methods for the Examination of Water and Wastewater). The main problem for their use in rhizosphere solution analysis is that these methods normally work with large sample volumes (e.g. 10 mL). However, some miniaturization of the procedures should be possible.

Basic references

Standard Methods for the Examination of Water and Wastewater. 17th Edition, 1989, American Public Health Association, Washington, DC

Application areas

These methods need at least 1-2 mL of solution and are therefore not applicable to samples from microsuction cups (only after dilution and loss of detection limit).

Problems, constraints, do's and don'ts

The colorimetric methods are well established in analytical chemistry. The small sample volume may pose problems (no duplicate samples, dilution and therefore loss of sensitivity). The use of flow injection analysis (FIA) may further reduce the required sample volume.

Specific contribution to rhizosphere research

These methods have not been used a lot in rhizosphere research but they are simple to carry out and may give some indication on the processes that take place in the rhizosphere. However, they do not replace component-specific measurements by chromatographic methods (see **chapter 3.1.**).

Related method sheets

ID	23_Graf-Pannatier
Parameter	Inorganic Composition of Forest Soil Solutions (incl. sum parameters for organic C and N)
Soil type	Acid and calcareous forest soils
System	Field and Model Ecosystems
Method	Analysis of pH, electrical conductivity, inorganic anions, total element concentrations (nutrients, aluminum, trace metals), inorganic and organic carbon

ID	23_Jones_a
Parameter	Dissolved inorganic and organic phosphorus in soil solution
Soil type	Any soil
Plant species	Any vegetation
System	All systems
Method	Colorimetric determination

ID	23_Jones_b
Parameter	Dissolved organic nitrogen in soil solution
Soil type	Any soil
Plant species	Any vegetation
System	All systems
Method	Colorimetric determination

ID	23_Nourrisson
Parameter	Total element (Al, Si, Ca, Fe, K, Mg, Mn, TOC) and ion (NH₄⁺, NO₃⁻, Cl⁻, F⁻, SO₄²⁻, PO₄²⁻) concentrations, pH in soil solution
Soil type	acid forest soil
Plant species	All forested species
System	Soil solutions obtained by micro-suction cups in field soil or in microcosm
Method	A chain of analyses adapted to volumes of < 2ml

2.3.5. Speciation of metals

Brief method description

The total concentration of metals is often only of limited significance with respect to their bioavailability. Knowledge about the chemical speciation is needed in addition to the total concentration. This chapter presents speciation methods from 3 areas:

- speciation of aluminum in soil solution,
- speciation of metals in solution,
- the use of DGT for speciation of metals.

a) Aluminum is a very important element in acidic forest soils due to its pronounced root toxicity. Rhizosphere-specific methods for the determination of Al-speciation have been developed based on capillary electrophoresis (CE, **23_Goettlein_b**), extraction into an organic phase in the presence of a ligand (**23_Boudot**), by flow-injection analysis (FIA, **23_Luster**) and by the Donnan-membrane technique (DMT, **23_Temminghoff**).

method	species	Comment
CE	Al ³⁺	
DMT	Al ³⁺	
Extraction	Inorganic, monomeric Al	Al ³⁺ by calculation
FIA	Mononuclear and labile Al	

The described CE method measures free Al³⁺, the main target species. The

DMT-technique also measures free Al³⁺ but is limited to large volumes of soil solution due to the applied flow-through system. Labile Al includes free Al³⁺, mononuclear hydrolytic species of Al (e.g. AlOH²⁺, Al(OH)₂⁺) and labile complexes with phenolic ligands. Inorganic monomeric Al includes in addition all complexes with low molecular weight organic compounds. These species are determined by extraction and FIA methods.

b) For the speciation of metals four methods are covered: the determination of free Cu²⁺ (or other metals) by ion-selective electrode (**23_Sauve_a**), the determination of labile Cu, Zn, Cd, and Pb using voltammetric methods (**23_Dessureault_Rompere**, **23_Kruyts**, **23_Sauve_b**), the use of cation exchange resins to determine free, labile and stable complexes (**23_Holm**), and the determination of free metals by the DMT-technique (**23_Temminghoff**). The Cu²⁺ measurement by electrode is as simple as a pH measurement and has a very low detection limit both in soil extracts as well as in soil solution. In principle other ion-specific electrodes (e.g. Pb²⁺ or Cd²⁺) could also be used but they have not yet been applied to soil solution.

DPASV (differential pulse anodic stripping voltammetry) is a simple method to determine metal speciation. DPASV does not give directly the free metal concentration but the concentration of labile metals (mainly inorganic complexes plus some weak labile organic complexes). The free metal ion concentrations can be calculated using chemical equilibrium calculations.

An alternative electrochemical method uses a gel integrated microsensor which consists of an agarose membrane-covered Hg-plated Ir-based microelectrode array (μ -AMMIA). This technique measures the so-called "dynamic" species, i.e. free ions and small labile complexes with size of a few nm, which dissociate during the time of the measurement. "Labile" and "dynamic" represent largely the same metal species.

Cation exchange columns can be used to determine free metals, labile and stable metals complexes. A cation exchanger with known adsorption characteristics for metals is brought in contact with the solution and measured dissolved metal concentrations are used to calculate the free metal concentrations. Chelex resin can be used to distinguish between complexes that are labile and dissociate during passage through a column and those that are inert.

The Donnan membrane technique (DMT) uses a negatively charged ion-exchange membrane for the selective transfer of free metals across the membrane into a receptor solution. The free metals can be measured in this solution using ICP-MS and multiple free metals can be measured at the same time. It is the big advantage of this method that many free metals can be measured at the same time. The problem with the method is that it is yet restricted to large sample volumes.

c) With DGT (diffusive gradients in thin films) we can measure the so-called effective concentration C_e in soils (23_Zhang_b). C_e includes the soil solution concentration, diffusive transfer from solution to the DGT device as well as resupply from the solid phase and possible depletion of the solid phase. In conjunction with the total metal concentration in soil solution, C_e gives information about the bioavailability of metals for organisms (e.g. plants). It is applied on moist soils and not to soil solution but gives information on the bioavailable soil solution concentration.

Application areas

The methods can be applied to soil extracts, soil solution and rhizosphere soil solution.

Problems, constraints, do's and don'ts

Most speciation methods need quite large sample volumes. Miniaturization of the methods is necessary before rhizosphere samples can be measured. The use of microelectrodes instead of a

polarograph may allow the voltammetric determination of metal speciation in rhizosphere solution sampled by microsuction cups. The use of the microelectrode array (μ -AMMIA) might be especially useful in this context.

Specific contribution to rhizosphere research

Despite the importance of knowing the metal speciation, these methods have received almost no attention in rhizosphere research except for Al speciation. Methodological difficulties with downscaling the methods to the small sample volumes may be the cause.

Related method sheets:

ID	23_Boudot
Parameter	Al speciation in soil solutions
Soil type	acid soils
System	Soil solutions obtained by microsuction cups
Method	Complete speciation scheme involving fast reaction with 8-hydroxyquinoline, ion chromatography, determination of total Al concentrations, and equilibrium calculations

ID	23_Cattani
Parameter	Available and soluble Cu in soils, available and soluble (total and labile) As, pH of rhizosphere soil solution
Soil type	calcareous sandy soil (Cu), clayey soil (As)
Plant species	Zea mays (Cu), Pteris cretica (As)
System	rhizoboxes (Cu), lysimeters (As)
Method	DGT, rhizon soil solution sampler

ID	23_Dessureault_Rompre
Parameter	Speciation analysis of Cu, Pb, Cd and Zn in soil solutions
Soil type	Agricultural topsoil
Plant species	<i>Lupinus albus</i> , <i>Thlaspi caerulescens</i> , <i>Thlaspi perfoliatum</i>
System	Rhizobox
Method	Square wave anodic stripping voltammetric technique with gel integrated microelectrode arrays

ID	23_Goettlein_b
Parameter	Metal speciation in micro samples of soil solution
Soil type	Acid forest soils
Plant species	Oak
System	Rhizotrones, root windows
Method	Capillary Electrophoresis (CE) and ICP-OES with microinjection

ID	23_Holm
Parameter	Simultaneous determination of free Cd and Zn divalent ions and the operationally defined complexed fractions (labile, slowly labile, and stable complexes) in soil solutions
Soil type	all soils with pH between 5 and 7
Plant species	all
System	Soil solution, rhizosphere soil solution
Method	Two-part batch-column-batch procedure using two cation exchange resins and analytical determination by graphite furnace atomic absorption spectrometry (GF-AAS)

ID	23_Kruyts
Parameter	Metal (e.g. Zn) labile fractions in soil solutions
Soil type	acid forest soil
System	field soil, rhizosphere and bulk
Method	Differential pulse anodic stripping voltammetry (DPASV)

ID	23_Luster
Parameter	Aluminum Speciation in Forest Soil Solutions
Soil type	Acid forest soils
System	Field
Method	Total Al by ICP / OES Monomeric Al by Eriochrome cyanine R method Complexation labile Al by 8-hydroxyquinoline method Al measured by capillary electrophoresis

ID	23_Sauve_a
Parameter	Free Cu in soil solution
Soil type	Any soil
System	Extracts to mimic soil solution
Method	Ion-selective electrode potentiometry

ID	23_Sauve_b
Parameter	Free and labile Cd, Pb and Zn in soil solution
Soil type	Any soil
System	Soil solution extracts
Method	Differential pulse anodic stripping voltammetry and speciation calculations

ID	23_Temminghoff
Parameter	Total as well as 'free' metal ion concentration in aqueous (soil) solutions
Soil type	Any soil
System	surface waters, soil solutions, soil columns, sediments
Method	Donnan Membrane Technique (DMT)

ID	23_Zhang_b
Parameter	Effective concentrations C_e (As, Zn, Cu, Cd, Pb) in soil solution
Soil type	All soil types
Plant species	<i>Lepidium heterophyllum</i> , <i>Triticum aestivum</i> L., <i>Lepidium sativum</i> , <i>Pteris vittata</i> L.
System	field soils and microcosm
Method	DGT (diffusive gradients in thin-films)

Editor: Neumann, Günter
Institute of Plant Nutrition (330), Hohenheim University, 70593 Stuttgart,
Germany
gd.neumann@t-online.de,

3.1.1 Introduction

The chapter presents a collection of various tools for detection and determination of organic compounds in root exudates and rhizosphere soil solutions.

Different sampling techniques are described for plants grown in hydroponics and for soil-grown plants, using rhizobox systems or root-window approaches. Simple analytical tests for different classes of compounds (e.g. sugars, amino acids, phenolics), allowing rapid screening of larger sample series are included, as well as technically more sophisticated methods for specific determination of compounds with special functions in the rhizosphere, such as phytosiderophores, organic chelators, and substances involved bacterial and plant-bacterial signalling (e.g. flavonoids, homoserine lactones).

In many cases it is possible to use the presented techniques for analysis of the respective compounds also in root- and plant tissues, and some presentations refer to the detection of intracellular indicator compounds in plant roots, such as analysis of fatty acid methyl esters for characterization of mycorrhizal associations and detection of callose production as stress indicator.

Additionally, various *in situ* techniques for non-destructive detection of chemical changes, induced by the presence of root exudates are described, comprising reduction of Mn and Fe, as well as complexation of aluminium. The detection and analysis of activities of ecto-enzymes such as phosphatases, proteases, glucanases and chitinases is covered by **chapter 4.2**.

For further information concerning analytical techniques the reader is referred to methodological monographs on soil and plant analysis.

Harborne, J.B. 1998. *Phytochemical Methods - a Guide to Modern Techniques of Plant Analysis*. Chapman & Hall, London

Smit, A.L.; Bengough, A.G.; Engels, C.; Van Noordwijk, M.; Pellerin, S.; Van de Geijn, S.C. (eds.) 2000. *Root Methods - A Handbook*, Springer, Berlin, Heidelberg.

Wolt, J. 1994. *Soil solution chemistry: Applications to environmental science and agriculture*. John Wiley and Sons, New York.

3.1.2. Collection techniques for root exudates and rhizosphere soil solution

Brief method description

The collection of organic compounds released from plant roots is the prerequisite for subsequent analysis. This section comprises the description of different collection techniques, applicable for plants grown in hydroponics, in solid substrates (e.g. sand culture), and in soils.

Probably the easiest way to collect root exudates and other root-derived organic compounds, is the collection of root washings from plants grown in hydroponics, either in free-solution culture or in solid substrates, such as sand or vermiculite and in special cases even in soil culture. These techniques are based on trapping of root exudates by submerging root systems into trap solutions (water, nutrient solution), or percolating solid substrates with the trap solutions, finally yielding a diluted solution of high- and low-molecular weight organic compounds, released from the root system

during the collection period. Root exudation can be assessed by repeated non-destructive collections over extended time periods, and with some precautions axenic culture is possible, avoiding microbial degradation of exudate compounds.

However, in many cases, exudation is not uniformly distributed along plant roots and considerable longitudinal gradients or hot spots of exudation can exist in different root zones. Thus, collection techniques based on root washings or percolation with trap solutions, integrating root exudation over the whole root system, can only give limited information for rhizosphere processes, which frequently depend on the local concentrations of root exudates in the rhizosphere of distinct root zones (e.g. apical root zones, root hairs, cluster roots). Therefore, localized sampling techniques, based on application of various sorption media onto the root surface are described. Localized collection of rhizosphere soil solution is also possible by use of micro-suction cups (see **chapter 1.3.**). However, this technique has been mainly applied for the analysis of mineral elements in rhizosphere soil solutions, since organic compounds are easily decomposed by microorganisms due to the comparatively long collection periods required for this method.

Basic References

Engels, C.; Neumann, G.; Gahoonia, T.; George, E.; Schenk, M. 2000. Assessment of the ability of roots for nutrient acquisition. In: Smit, A.L.; Bengough, A.G.; Engels, C.; Van Noordwijk, M.; Pellerin, S.; Van de Geijn, S.C. (eds.) 2000. *Root Methods – A Handbook*, Springer, Berlin, Heidelberg, pp. 403-459.

Neumann, G.; Römheld, V. 2000. The release of root exudates as affected by the plant physiological status. In: Pinton, R.; Varanini, Z.; Nannipieri, Z. (eds.) *The Rhizosphere: Biochemistry and organic substances at the soil-plant interface*. Marcel Dekker, New York, pp.41-89.

Smit, A.L.; George, E.; Groenwold, J. 2000. Root observations and measurements at (transparent) interfaces with soil. In: Smit, A.L.; Bengough, A.G.; Engels, C.; Van Noordwijk, M.; Pellerin, S.; Van de Geijn, S.C. (eds.) 2000. *Root Methods – A Handbook*, Springer, Berlin, Heidelberg, pp. 235-272.

Application areas

The use of root washings with trap solutions is mainly confined to plants grown in hydroponics. Percolation with trap solutions can be applied for plants cultivated in solid substrates, such as sand culture and in exceptional cases also for sandy soils. All techniques mentioned so far are applicable for laboratory studies if no spatial resolution is required, e.g.: for demonstration of basic physiological reactions related with changes in root exudation; for collection of exudate compounds on a preparative scale, or for quantification of total carbon flow from roots by use of isotopic labeling techniques.

For more detailed investigations, considering gradients of exudation along the roots, and for real rhizosphere studies, localized sampling techniques are essential. Localized collection of root exudates by application of sorption media onto the root surface can be employed, both, for plants grown in hydroponics and in soil culture, using rhizobox systems or even root-observation windows under field conditions (see **chapter 1.1.**). These techniques allow repeated, non-destructive measurements over extended time periods with a high spatial resolution.

Problems, constraints, do's and don'ts

A major problem of all techniques used for collection of root exudates is the risk of microbial degradation during the collection period and the limited ability to differentiate between root exudates and microbial metabolites in the rhizosphere. In hydroponic systems, axenic culture can be employed to avoid microbial degradation of root exudates. However, it should be kept in mind that root exudation can be strongly affected by the presence of microorganisms. Sterile culture under soil conditions is extremely difficult to perform. The use of antibiotics prior and during the collection period is not recommended since rhizotoxic effects cannot be excluded. Half-life times of several hours have been determined for easy degradable organic compounds (e.g. sugars, organic acids in soil solutions). Therefore, short collection periods (1-2 h)

can minimize the risk of microbial degradation. Short-term isotopic labeling techniques (pulse-chase labeling) can help to differentiate between root exudates and microbial metabolites.

Careful handling of roots is essential to avoid root damage during immersion of root systems into trap solutions or application of sorption media. For short collection periods (1-2 h), distilled water can be used as trap solution. For longer collection periods (e.g. for collection of phenolics), 0.5 mM CaSO₄ should be added for membrane stabilization. Washing or removing of roots from solid substrates for subsequent exudate collection should be avoided since root injury cannot be excluded.

For localized collection techniques from soil grown plants it should be kept in mind that sampling is possible only for compounds dissolved in the rhizosphere soil solution. However, various exudate compounds (e.g. carboxylates, phenolics, ectoenzymes) can exhibit rapid adsorption to the soil matrix or to the cell wall and recovery experiments are essential.

Exudates collected by root washings or percolation techniques are usually highly diluted and require subsequent concentration steps, which can be performed by lyophilization, vacuum concentration (if the compounds of interest are not heat-labile), or solid-phase extraction techniques. Particularly percolates can contain substantial amounts of salts originating from the nutrient solution, and may require pre-purification steps with ion exchangers to avoid interferences during sample concentration.

In contrast, for samples obtained with localized collection techniques, subsequent concentration is frequently not required and direct analysis is possible. However, in these cases, small sample volumes can be a limiting factor. Localized sampling can be also limited by very fine roots or low levels of soil moisture.

Specific contribution to rhizosphere research

All techniques described in this section can contribute significant information for problems in rhizosphere research. Root washing and percolation techniques are tools for basic model studies, while localized collection techniques with soil-grown plants offer the opportunity to for real rhizosphere studies under more realistic conditions

Related method sheets

ID	31_Kuzyakov_a
Parameter	Diffusion of exudates from root surface
Soil type	unimportant, preferably not sandy soil
Plant species	grasses, unimportant
System	Microcosm
Method	¹⁴C pulse labeling, root mat technique, and collection of rhizosphere soil by slicing

ID	31_Kuzyakov_b
Parameter	Simultaneous collection of root exudates and measurement of root respiration
Soil type	preferably sandy
Plant species	grasses
System	Microcosm
Method	¹⁴C pulse labeling; elution of root exudates for composition analysis with simultaneous CO₂ trapping

ID	31_Morel
Parameter	Mucilages and soluble high-molecular weight exudates
Plant species	Maize
System	Axenic and non axenic microcosm
Method	Collection and characterization of macromolecular rhizodeposits

ID	31_Neumann_a
Parameter	Collection of Root exudates
Plant species	All species
System	Hydroponics
Method	Localized collection of root exudates by use of sorption media from plants grown in hydroponics

ID	31_Neumann_b
Parameter	Collection of root exudates and rhizosphere soil solution from soil-grown plants
Soil type	All soils
Plant species	All species
System	Rhizoboxes, field studies with root windows
Method	Localized collection by use of sorption media

3.1.3. Low molecular weight compounds in plant roots, root exudates and soil solutions

Brief method description

The applications for determination of low-molecular weight (LMW) compounds in root exudates, plant extracts and soil solutions are usually based on standard analytical methods in biochemistry and can be divided into two groups:

- analytical techniques for determination of different classes of compounds, such as sugars, amino acids, phenolics. These tests are mainly based on derivatization reactions with subsequent spectrophotometric detection and calibration with representative standards for the respective groups of compounds. Usually, these methods can be easily and rapidly performed for large sample series with basic laboratory equipment and can give a first overview concerning quantitative relations of LMW-organics in the sample.
- for more detailed information, individual compounds are analyzed after chromatographic separation or by specific enzyme-coupled reactions. High performance liquid chromatography (HPLC) systems with stationary phases, based on reversed-phase silica, ion-exclusion-, or ion-exchange resins and subsequent spectrophotometric-, fluorescence-, or conductivity-detection with or without derivatization, are most frequently employed in rhizosphere research. But also gas chromatography (GC) and more recently capillary electrophoresis (CE) and alternative detection modes, such as pulse amperometry (PAD) and

mass spectrometry (MS) have been introduced.

For more detailed background information regarding the different analytical techniques, the reader is referred to the respective analytical monographs.

Basic references

Bergmeyer, H.U. 1998. Methods of Enzymatic Analysis, 4th edition, Wiley-VCH, Weinheim, Germany.

Harborne, J.B. 1998. Phytochemical Methods - a Guide to Modern Techniques of Plant Analysis. Chapman & Hall, London

Weinberger, R. 2000. Practical Capillary Electrophoresis, Academic Press, London.

Weiß, J. 2004. Handbook of Ion Chromatography, 3rd edition, Wiley-VCH, Weinheim, Germany.

Wolt, J. 1994. Soil solution chemistry: Applications to environmental science and agriculture. John Wiley and Sons, New York.

Application areas

In principle, spectrophotometric methods for detection of different classes of compounds (as sum parameters) can be employed for a wide range of different matrices, such as soil solutions, root exudates and plant extracts. Depending on the respective method, pH-adjustment of the sample may be necessary. Additionally, pilot-recovery experiments with addition of standard-compounds to the sample are recommended for different matrices, to check for potential interferences.

Since the different groups of compounds are labeled by more or less specific derivatization reactions prior to spectrophotometric detection, it should be kept in mind that only quantification relative to a selected standard compound is possible. Absolute quantification is biased by potential differences in derivatization of individual substances. Although many of the spectrophotometric methods have been originally developed for plant extracts with high concentrations of organic compounds, limiting sample volumes and low concentrations, frequently characteristic for rhizosphere samples, can be compensated in many

cases by downscaling of the methods. By using microcuvettes with volumes < 0.5 mL for spectrophotometric analysis or even microplate readers, the required sample volume can be frequently reduced to several micro-liters.

In most cases, sample volume is not a limiting factor for detection of individual substances by chromatographic methods (HPLC, ion chromatography, GC) with usual injection volumes of 10-20 µL, which can be further reduced by use of micro-bore columns. In the case of capillary electrophoresis (CE), only nano-liter volumes are required.

Problems, constraints, do's and don'ts

Particularly for the analysis of (rhizosphere-) soil solutions and root exudates the presence of mineral ions (e.g. nitrate, metals) can cause interferences in chromatographic separations coupled with direct UV detection, conductivity detection or PAD. In these cases pre-purification steps with ion exchangers are required.

Identification and quantification of individual compounds is usually performed by comparison with known standards. For individual sugars, amino acids and carboxylic acids, high-purity standards are commercially available. However, routine analysis of secondary plant and microbial products can be limited by the availability of the respective standards.

Since highly specific MS-coupled detection techniques are still not widespread in most laboratories, identification of individual compounds in chromatographic separations should not only be based on comparison of retention times with known standards. Modern spectro-photometric detectors allow recording and comparison of absorption spectra of single peaks (due to the higher sensitivity, spectrophotometers are preferential to diode-array detectors for analysis of rhizosphere samples). Moreover, a large number of enzyme-coupled reactions is available for specific determination of LMW-compounds, which can be additionally employed for identification of single compounds in

selected representative samples. In cases where detection of only one or two specific compounds is required, enzymatic tests can be even preferential compared with chromatographic separations in terms of specificity and speed of analysis, with sensitivity ranges comparable to standard HPLC applications.

Specific contribution to rhizosphere research

The described methods are widely used in rhizosphere research.

Related method sheets

ID	31_Delhaize
Parameter	Aluminium-induced malate exudation
Plant species	Wheat (and others)
System	Hydroponics
Method	Enzymatic assay

ID	31_Eldhuset
Parameter	Low molecular weight organic acids in root exudates and soil solutions
Soil type	Forest soil (thick fluvial sediments with silty loam and sandy loam texture).
Plant species	Norway spruce (<i>Picea abies</i>), silver birch (<i>Betula pendula</i>)
System	Field soil, soil in rhizoboxes, soda glass beads in sterile microcosms
Method	Ion exclusion HPLC

ID	31_Heim_a
Parameter	Organic Acids in Roots and Root Exudates
Plant species	Norway spruce, European Chestnut
System	Hydroponics and Perlite Culture in Growth Chamber
Method	Capillary electrophoresis

ID	31_Heim_b
Parameter	Phenolic Substances in Roots and Root Exudates
Plant species	Norway spruce
System	Hydroponics and Perlite Culture in Growth Chamber
Method	Total phenolics: colorimetric assay Root phenolics: Reversed-phase liquid chromatography (RPLC) Fluorescence of root exudates

ID	31_Jones_a
Parameter	Total free amino acids in soil solution and soil extracts
Soil type	Any soil
Method	Fluorometric determination

ID	31_Jones_b
Parameter	Total phenols in soil solution and soil extracts
Soil type	Any soil
Plant species	Any vegetation
System	All systems
Method	Colorimetric Assay

ID	31_Kraigher
Parameter	Cytokinin analyses in plant tissues, mycorrhizae and fungal cultures
Soil type	Forest soils
Plant species	Spruce
System	Erlenmayer flasks with soil substrates or liquid medium with support for seedlings
Method	HPLC-ELISA – identification and quantification of cytokinins

ID	31_Neumann_c
Parameter	Organic acids in root exudates and plant extracts
Plant species	All species
System	All systems
Method	Reversed Phase HPLC with suppressed ionization

ID	31_Neumann_d
Parameter	Phytosiderophores in root exudates and plant extracts
Plant species	Graminaceous plants
System	Hydroponics; (soil culture)
Method	Anion-exchange HPLC

ID	31_Neumann_g
Parameter	<i>In situ</i> detection of phenolic compounds in the rhizosphere
Soil type	All soils
Plant species	All species
System	Hydroponics, Soil culture in rhizoboxes
Method	Direct UV detection; Collection with filter paper and analysis of the extracted phenolics with colorimetry or RP-HPLC

ID	31_Neumann_h
Parameter	Quantitative determination of sucrose and reducing sugars in root exudates and soil solution
Soil type	All soils
Plant species	All species
System	Hydroponics, Soil culture in rhizoboxes
Method	Colorimetry

3.1.4. High-molecular weight compounds in plant roots, root exudates and soil solutions

Brief method description

This section describes the collection and analysis of high-molecular weight (HMW) compounds in root exudates, mainly consisting of mucilage-polysaccharides (poly-uronic acids), proteins and ectoenzymes. Soluble macromolecules in exudate samples can be separated from LMW-compounds by dialysis, ultrafiltration or precipitation techniques (e.g. salt- or acid-precipitation for proteins, precipitation with organic solvents for proteins+polysaccharides). The isolated macromolecular fractions can be further characterized by electrophoresis (proteins), size-exclusion chromatography (proteins, polysaccharides), spectrophotometric assays (proteins), monomer analysis after hydrolysis, and MS-techniques for characterization of macromolecules,

Methods for detection of specific polymers in root tissues, such as callose as stress-indicator and chitin as marker for mycorrhizal colonization are also included. For more general analysis of plant macromolecules the reader is referred to the respective monographs on plant analysis.

Basic references

Bergmeyer, H.U. 1998. Methods of Enzymatic Analysis. 4th edition, Wiley-VCH, Weinheim, Germany.

Harborne, J.B. 1998. Phytochemical Methods - a Guide to Modern Techniques of Plant Analysis. Chapman & Hall, London.

Application areas

The isolation and characterization of macromolecules in root exudates is mainly confined to plants grown in hydroponics and sand culture, although ecto-enzymes can be also detected at the root surface of soil-grown plants in rhizobox or root-window systems by *in situ* activity staining or in rhizosphere soil samples (see

chapter 4.2). Pure mucilage can be directly collected from root tips by immersing plant roots into water, which induces imbibition and swelling of the mucilage layer. Provided that the roots are not too fine, drops of mucilage can be collected in apical root zones, using forceps or sorption filters. Mucigel (mucilage with inclusions of soil particles and micro-organisms) can be isolated from rhizospheres of many graminaceous plant species in soil culture, while glomalin, a specific protein released from hyphae of AM-fungi has been detected with specific antibodies in soil samples obtained from mycorrhizal plants.

Problems, constraints, do's and don'ts

A clear differentiation of root-borne polymers from microbial macromolecules is only possible by use of axenic culture systems. In case of proteins specific antibodies may be employed. High loads of salts originating from nutrient solutions can cause problems for later characterization of mucilage preparations isolated from root washings.

Specific contribution to rhizosphere research

The detection of enzyme activities in the rhizosphere and characterization of mucilage properties has been widely used in rhizosphere research.

Related method sheets

ID	31_Hirano
Parameter	Callose concentrations in tree roots
Soil type	Acid forest soils
Plant species	Norway spruce, Poplar, Chestnut
System	Hydroponics, Sand culture, Field
Method	Fluorescence spectroscopy

ID	31_Jansa_a
Parameter	Chitin in roots colonized by arbuscular mycorrhizal fungi (AMF)
Plant species	any plant with nonwoody roots
System	pot experiment samples
Method	HPLC analysis of hydrolysate

ID	31_Jansa_c
Parameter	Isoenzymes and Total proteins
Soil type	none tested by the author
Plant species	maize, clover, leek (model plants in AMF research)
System	pot experiments
Method	Isoenzyme and total protein profiles of plant roots colonized by arbuscular mycorrhizal fungi (AMF)

ID	31_Morel
Parameter	Mucilages and soluble high-molecular weight exudates
Plant species	Maize
System	Axenic and non axenic microcosm
Method	Collection and characterization of macromolecular rhizodeposits

3.1.5. (Plant-) Microbial Interactions

Brief method description

The characterization of signal compounds involved in plant-microbial interactions is most advanced in the legume-*Rhizobium* symbiosis but also in plant-pathogen-, and allelopathic interactions. An interesting field of research, emerging in the recent past, is the investigation of inter- and intra-specific communication strategies within soil and rhizosphere-bacterial populations (quorum sensing, formation of bio-films, bacterial exo-polysaccharides) and the role of root-borne signals in this cross-talk.

Various chromatographic techniques (HPLC, GC, CE), frequently coupled with MS detection, but also bacterial strains transformed with reporter genes, bacterial chemotaxis assays and immunochemical techniques have been employed for detection and characterization of signal molecules in the rhizosphere,

The analysis of indicator compounds, such as chitin or specific fatty acid profiles can be employed for indirect quantification of certain groups of microorganisms in soils or even in plant roots (e.g. mycorrhizal fungi).

Basic references

Harborne, J.B. 1998. *Phytochemical Methods - a Guide to Modern Techniques of Plant Analysis*. Chapman & Hall, London

Mabry, T.J.; Markham, K.R.; Thomas, M.B. 1970. The systematic identification of flavonoids. Springer, Berlin, Heidelberg.

Pinton, R.; Varanini, Z.; Nannipieri, Z. (eds.) 2000. The Rhizosphere: Biochemistry and organic substances at the soil-plant interface. Marcel Dekker, New York.

Application areas

Signal compounds are frequently present and active in extremely low concentrations. The compounds of interest are usually products of the secondary metabolism of plants and microorganisms and therefore, pure standards for identification and calibration are only rarely available. This frequently requires intensive steps of pre-purification and sample enrichment, as well as the application of advanced and specific techniques for detection and structure elucidation. Therefore, most studies have so far been conducted under controlled conditions in plant-hydroponics and bacterial culture media.

Problems, constraints, do's and don'ts

The isolation of secondary metabolites from root exudates requires special care for sample preparation. Water solubility is frequently lower than for other LMW compounds, such as sugars, amino acids or carboxylates. Longer collection periods (4-8 h) can help to increase the amounts of secondary metabolites, recovered during exudate collection. In these cases addition of 0.5 mM CaSO₄ to the trap solution is recommended for membrane-stabilization. Root-washing techniques are usually resulting in very diluted solutions of secondary metabolites, requiring further sample enrichment prior to analysis. Particularly phenolic compounds can exhibit complexing properties and are easily oxidized. Simple vacuum concentration at temperatures of 40-50°C, as frequently performed for other LMW-exudate compounds, can cause structural alterations of phenolics and is therefore not feasible. Alternatively, lyophilization, or solid-phase extraction (e.g. C-18 cartridges) with subsequent elution by organic solvents, which can be easily evaporated at lower temperatures, can be

employed for sample concentration and pre-fractionation.

A large number of different glycosylation and acylation patterns is the cause of the enormous structural heterogeneity of secondary metabolites, which limits the commercial availability of standards for identification and quantification. However, at least for the free, non-conjugated aglyca, numerous standards are available and can provide valuable structural information after sample-hydrolysis. Provided that the compounds of interest can be enriched in sufficient amounts, a wide range of additional techniques (e.g. thin-layer chromatography with color reactions and analysis of chemical shifts in UV/Vis-absorbtion spectra) can be additionally employed for structure elucidation when more sophisticated MS-based techniques for structure analysis are not readily available.

Specific contribution to rhizosphere research

The investigation of inter- and intra-specific signal events is a pre-requisite for understanding (plant)-microbial interactions in the rhizosphere. Although many experiments have been conducted under controlled and artificial conditions and direct investigations in the rhizosphere are difficult, the analytical complexity encourages the development and introduction of novel techniques with a potential for wider application in rhizosphere research.

Related method sheets

ID	13_Englmann
Parameter	Analysis of <i>N</i>-Acylhomoserine Lactones after Alkaline Hydrolysis
System	Bacterial culture media
Method	Anion Exchange Solid Phase Extraction followed by Capillary Zone Electrophoresis Coupled to Mass Spectrometry (CZE-ESI/MS)

ID	31_Frommberger_a
Parameter	Analysis of <i>N</i>-Acylhomoserine Lactones
System	Bacterial culture media
Method	Gas Chromatography Coupled to Mass Spectrometry (GC-MS)

ID	31_Frommberger_b
Parameter	Analysis of <i>N</i>-Acylhomoserine Lactones
System	Bacterial culture media
Method	partial Filling Micellar Electrokinetic Chromatography coupled to Mass Spectrometry (PF-MEKC-ESI/MS)

ID	31_Frommberger_c
Parameter	Analysis of <i>N</i>-Acylhomoserine Lactones
System	Bacterial culture media
Method	Nano-Liquid Chromatography Coupled to Mass Spectrometry (NanoLC-ESI/MS)

ID	31_Heim_b
Parameter	Phenolic Substances in Roots and Root Exudates
Plant species	Norway spruce
System	Hydroponics and Perlite Culture in Growth Chamber
Method	Total phenolics: colorimetric assay Root phenolics: Reversed-phase liquid chromatography (RPLC) Fluorescence of root exudates

ID	31_Jansa_b
Parameter	Fatty acids
Soil type	not tested by the author
Plant species	cereals, legumes, leek (model host plants for AMF research)
System	pot experiments
Method	Assessment of fatty acid methyl ester (FAME) profiles in roots colonized by arbuscular mycorrhizal fungi (AMF)

ID	31_Neumann_g
Parameter	<i>In situ</i> detection of phenolic compounds in the rhizosphere
Soil type	All soils
Plant species	All species
System	Hydroponics, Soil culture in rhizoboxes
Method	Direct UV detection; Collection with filter paper and analysis of the extracted phenolics with colorimetry or RP-HPLC

3.1.6. *In situ* detection of rhizosphere-chemical changes

Brief method description

Organic compounds released from plant roots can trigger various chemical changes in the rhizosphere. In rhizobox- or root-window systems, agar sheets, filter papers or membrane filters applied onto the root surface can act as carrier matrix for indicator compounds for non-destructive detection of root-induced chemical changes: Activities of ectoenzymes can be visualized by turnover of artificial substrates, triggering color reactions (see also **chapter 4.2.**). Root-induced metal complexation (Fe, Mn, Al) can be detected by use of various colored metal-chelators and redox changes by colored redox-indicators. Provided that the concentration of the applied indicator compounds is not rate-limiting, semi-quantitative detection is possible and even quantitative measurements have been performed, using video-densitometry.

Application areas

Non-destructive techniques can be employed both for plants grown in hydroponics and for soil-grown plants in rhizoboxes and even under field-conditions using root-observation windows. Depending on the intensity of the root-induced chemical changes, incubation times can vary from several minutes up to several days. Very low levels of soil moisture can cause problems due to induction of water-flow out of the carrier matrix into the soil, which can limit the color reactions.

Problems, constraints, do's and don'ts

Proper contact of the carrier media containing indicator reagents with the root surface is essential. Therefore, agar sheets or filters may be covered with plastic foil and the lids of rhizoboxes or root-observation windows should be closed during the incubation period. Best contact is achieved when the rhizosphere is infiltrated with solidifying agar as carrier

matrix. However, using this treatment, repeated measurements over extended time periods are no longer possible. It should be also kept in mind that the extension of reaction zones observed on the carrier-media do not necessarily reflect the real extension of the respective reactions in the rhizosphere, due to potential differences in diffusion zones. Moreover, in many cases the observed reactions reflect the sum of different processes in the rhizosphere rather than reactions caused by one single factor.

Specific contribution to rhizosphere research

The described techniques have been widely used in rhizosphere research, particularly in rhizobox systems. They can be employed as a powerful tool for spatial and semi-quantitative localization of rhizosphere-chemical changes as a base for more detailed investigations and as visual demonstration techniques for teaching and education.

Related method sheets

ID	31_Neumann_e
Parameter	<i>In situ</i> detection of root-induced Al complexation
Soil type	All soils
Plant species	All species
System	Hydroponics, Soil culture in rhizoboxes
Method	Application of gels containing Al chelator

ID	31_Neumann_f
Parameter	<i>In situ</i> detection of root-induced Mn-reduction
Soil type	All soils
Plant species	All species
System	Hydroponics, Soil culture in rhizoboxes
Method	Application of MnO₂-impregnated filter papers

ID	31_Neumann_i
Parameter	<i>In situ</i> detection of root-induced FeIII-reduction
Soil type	All soils
Plant species	All species
System	Hydroponics, Soil culture in rhizoboxes
Method	Application of agar gels containing Fe redox indicators

ID	31_Neumann_j
Parameter	<i>In situ</i> detection of acid phosphatase in the rhizosphere
Soil type	All soils
Plant species	All species
System	Hydroponics, Soil culture in rhizoboxes
Method	Application of filter papers soaked with artificial substrates

Editor: Robin, Christophe

UMR INRA-INPL(ENSAIA) "Agronomie et Environnement", BP 172, F-54505,
Vandoeuvre-les-Nancy Cedex, France

Christophe.Robin@ensaia.inpl-nancy.fr

3.2.1. Introduction

The turn-over of organic matter and element cycling is particularly difficult to assess in the field or in soil microcosms, especially in the rhizosphere, for which many challenges remain for research:

- the *in situ* quantification and localisation of the root released organic compounds;
- the identification, quantification of the different rhizosphere compartments (rhizosphere soil vs. bulk soil, rhizosphere soil vs. detritosphere, mycorrhizosphere, available compounds for microbial biomass, fungal vs bacterial biomass,...), and fluxes between compartments;
- the fate of those compounds in the different rhizosphere compartments (from plants to soil organic matter through biotransformation by microbial communities).

Nowadays different kind of methods are available. Among them, the following methodologies are covered in this chapter:

- for years, labelling techniques using stable and/or radioactive tracers are privileged and powerful tools to assess fluxes between compartments and / or the establishment of budgets
- additionally, isotope-based detection devices are the ideal tools for a global quantification of tracer in the plant-soil-microorganisms continuum
- promising techniques are under development for the quantification and localisation of root-released organic compounds; it includes the chemical characterization of organic compounds and the use of reporting biosensors.

Some important methods are not covered in this chapter because

- they represent refinements of the methods described here;
- they impose conditions where microorganisms are absent (sterile microcosms either with hydroponic systems or with sterilized substrates) and, therefore, are outside of the purpose of this chapter. Some of these methods are described in **chapter 3.1.**
- they are adapted to bulk soil, but either they lack of sensitivity in the case of rhizosphere soil or give rough estimates, without precise quantification of what really occurs in the rhizosphere (e.g.: indirect methods estimating the rhizomicrobial component of the rhizosphere respiration).

3.2.2. Labelling techniques

The methodologies involving isotopes (among them ^{13}C , ^{14}C , ^{11}C , ^{15}N , ^{32}P), are powerful research tools to assess the transfer and turn-over of elements in the plant, the soil and the microbial compartments. Overall, three tracer techniques are widely used to investigate the dynamics and budget of elements from atmosphere to the soil *via* the plant : 1) pulse-labelling, 2) continuous labelling, 3) natural abundance, each of them giving different information on the fate of C and N in the plant-soil system and are specific in their application areas and constraints.

Tracer techniques are also widely used to study i) the metabolic origin of an element within a compartment ii) the transformations and residence time of

elements in a compartment, iii) the transfer of an element between compartments.

a) **The pulse-labelling of plant shoots** consists of offering $^{14}\text{CO}_2$ or $^{13}\text{CO}_2$ or $^{11}\text{CO}_2$ (or $^{15}\text{NH}_4^+$ for studies on N rhizodeposition) to shoots for a short period, once during plant growth. It enables the time resolution between CO_2 (or NH_3) assimilation and rhizodeposition to be determined allowing fluxes of C (or N) through the plant into the soil to be quantified. A series of pulse-labelling can be applied at intervals during plant development to determine changes in C or N allocation in responses to rapid changes in the source-sink relationships in the plant imposed by phenology and/or by the environment.

Basic references

Meharg, A. 1994. A critical review of labelling techniques used to quantify rhizosphere carbon-flow. *Plant and Soil* 166: 55-62.

Merbach, W.; Schulze, J.; Richert, M.; Rocco, E.; Mengel, K. 2000. A comparison of different N-15 application techniques to study the N net rhizodeposition in the plant-soil system. *Journal of Plant Nutrition and Soil Science* 163: 375-379.

Minchin, P.E.H.; McNaughton, G.S. 1984. Exudation of recently fixed carbon by non-sterile roots. *Journal of Experimental Botany* 35: 74-82.

Swinnen, J.; Van Veen, J.A.; Merckx, R. 1995. Root decay and turnover of rhizodeposits in field-grown winter wheat and spring barley estimated by ^{14}C pulse-labelling. *Soil Biology and Biochemistry* 27: 211-217.

Warembourg, F.R.; Estelrich, H.D. 2000. Towards a better understanding of carbon flow in the rhizosphere: a time dependent approach using carbon-14. *Biology and Fertility of Soils* 30: 528-534.

Application areas

The technique can be applied in controlled environments or in the field (especially when stable isotopes are used). High temporal resolution: pulse-labelling is relevant to assess rapid changes in fluxes, that is not possible with continuous labelling.

Problems, constraints, do's and don'ts

The use of ^{11}C is limited due to its small half time. Moreover, very few labs in the world have actually the possibilities to produce ^{11}C .

Here are the main constraints in the use of artificial labelling of plants (valid for pulse and continuous labelling) :

- hermetic separation of roots from shoots, especially when the measurement of rhizosphere respiration is required, and to avoid $^{14}\text{CO}_2$ fixation by the enzyme Phospho-Enol Pyruvate Carboxylase in roots;
- regulation of climatic (CO_2 , temperature, hygrometry) and labelling (ratio $^{14}\text{C}/^{12}\text{C}$, $^{13}\text{C}/^{12}\text{C}$) parameters during labelling. Those points are crucial, especially in the case of studies on C allocation to rhizosphere. Despite their importance, they are not always regulated;
- cost of equipments for labelling and sample analyses, isotopes' cost, radioprotection and elimination of wastes (^{14}C).

In addition to those conditions, accurate sampling of the different soil compartments (especially collection of soil adhering to roots exempt of root tissues; see **chapter 1.3.**) is a prerequisite for rhizosphere studies.

Related method sheets

ID	32_Balesdent_a
Parameter	Nature and dynamics of rhizodeposited organic carbon
Soil type	any
Plant species	any
System	mesocosms (plant-soil systems transportable to the laboratory)
Method	Compound-specific stable isotope tracing

ID	32_Dennis
Parameter	^{14}C pulse labelling and allocation imaging
Soil type	All soils
Plant species	All species
System	Rhizoboxes
Method	^{14}C pulse labelling of plant material and ^{14}C allocation imaging using storage phosphor screens

ID	32_Kuzyakov
Parameter	Rhizodeposition; C input by plants into the soil
Soil type	unimportant
Plant species	mainly grasses, unimportant, not trees
System	microcosm, can be used under field conditions
Method	¹⁴C (¹³C) labeling

ID	32_Minchin
Parameter	Short-term carbon release from roots – either as gas or solute
Soil type	any
Plant species	any – but must have moderately fast phloem transport to the roots
System	hydroponic, soil
Method	¹¹C tracer experiment

ID	32_Robin
Parameter	¹⁴C assimilate allocation to rhizosphere compartments
Soil type	All kinds
Plant species	Various cultivated species including maize, ryegrass, <i>Medicago</i> sp.
System	field soil or artificially manipulated, in microcosms of different size
Method	¹⁴C-labelling of plant shoots, ¹²C-CO₂ and ¹⁴C-CO₂ monitoring

ID	32_Warembourg_a
Parameter	Rhizosphere C partitioning using ¹⁴C
Soil type	Artificial substrate, carbonate free soils
Plant species	Any, may be limited by the size of labelling chamber
System	Pots, monoliths in greenhouses and/or laboratory
Method	Short term labelling of plants with ¹⁴CO₂

ID	32_Warembourg_b
Parameter	N₂ fixation using ¹⁵N₂
Soil type	Artificial substrate, Soil
Plant species	N ₂ fixing plant-microbial associations
System	Pots in greenhouses and/or laboratory
Method	Exposure of plant roots to ¹⁵N₂

ID	32_Warembourg_c
Parameter	Rhizosphere C partitioning using ¹⁴C: Rhizosphere respiration
Soil type	Artificial substrate, soil
Plant species	Any plant
System	Pots in greenhouses and/or laboratory
Method	Separation of above and below-ground atmospheres and collection of CO₂

b) **Continuous labelling of plant shoots** consists of offering ¹⁴CO₂ or ¹³CO₂ to shoots for long periods (from first leaf emergence to sampling). In this case, cumulative data are obtained and C

budgets can be established. A combination of different tracer techniques (¹³C/¹⁵N or ¹⁴C/¹⁵N) or the dual labelling of the same element (¹³C and ¹⁴C) is an interesting field to make progress on understanding the plant-soil-micro-organisms interactions and the fate of organic matter.

Basic references

Johansson, G. 1993. Carbon distribution in grass (*Festuca pratensis* L.) during regrowth after cutting – utilization of stored and newly assimilated carbon. *Plant and Soil* 151: 11-20.

Kuzyakov, Y.; Domanski, G. 2000. Carbon input by plants into the soil. Review. *J. Plant Nutri. Soil Sci.* 163: 421-431.

Warembourg, F.R.; Paul, E.A. 1973. The use of ¹⁴CO₂ canopy techniques for measuring carbon transfer through the plant-soil system. *Plant and Soil* 38: 331-345.

Application areas

The method is appropriate for the separation of root-derived and SOM-derived CO₂ and for the estimation of the amount of C transferred by the plant into the soil. This method has poor temporal resolution and therefore it is not appropriate to reveal rapid changes in C fluxes imposed by plant development or by the environment. However, continuous labelling can be applied to field grown plants in undisturbed cores transported to the laboratory and to a canopy technique to label plants in the field.

Problems, constraints, do's and don'ts

Such techniques are difficult to apply in the field due to difficulties to regulate the labelling and plant growth conditions.

Related method sheets

ID	32_Robin
Parameter	¹⁴C assimilate allocation to rhizosphere compartments
Soil type	All kinds
Plant species	Various cultivated species including maize, ryegrass, <i>Medicago</i> sp.
System	field soil or artificially manipulated, in microcosms of different size
Method	¹⁴C-labelling of plant shoots, ¹²C-CO₂ and ¹⁴C-CO₂ monitoring

c) **The addition of labelled solid substrate to the soil** allows to trace its fate in the soil-micro-organism-plant continuum. The transformations (or the degradation) of the substrate into the soil and/or its uptake/utilization by soil micro-organisms or by plants can be studied.

The organic matter or molecule can be either labelled on a single element (ex : ¹³C, ¹⁴C or ¹⁵N) or dual labelled with ¹³C & ¹⁵N.

Basic references

Hodge, A.; Campbell, C.D.; Fitter, A.H. 2001. An arbuscular mycorrhizal fungus accelerates decomposition and acquires nitrogen directly from organic material. *Nature*, 413: 297-299.

Perelo, L.W.; Munch, J.C. 2005. Microbial immobilisation and turnover of C-13 labelled substrates in two arable soils under field and laboratory conditions. *Soil Biology Biochemistry* 37: 2263-2272.

Application areas

Short term and long term studies to investigate in all kind of soils, planted or not, the metabolic origin of a substrate within a compartment, the transformations and residence time of substrates in a compartment, the transfer of a substrate between compartments. Applicable in microcosms (stable or radioactive isotopes) or in the field (easier with stable isotopes due to rules and regulations applied when radio-isotopes are used in the field).

Problems, constraints, do's and don'ts

There are at least two prerequisites for a such labelling procedure : i) the size of the pool (or compartment) studied should

not change when the labelled substrate is supplied to this pool (e.g.: ¹⁴C-glucose used to trace the pool of soluble sugars) and ii) the pool (or compartment) to be labelled for tracing needs to be homogeneously labelled.

To obtain an accurate picture of microbial decomposition very short time incubation periods are required after the addition of the labelled substrate or the decomposition period is missed. For long-term transformation and transfer studies, the substrate needs to be labelled enough in order to avoid the detection limits due to the dilution of the tracer in the successive compartments within which it is incorporated.

Related method sheets

ID	32_Hodge
Parameter	Plant and AM colonised plant N capture from organic patches dual-labelled with ¹³C and ¹⁵N
Soil type	Loam soil
Plant species	Various grass species, <i>Plantago</i>
System	field soil, microcosms and temporally/spatially heterogeneous substrates (patches)
Method	Various microcosms

ID	32_Nguyen
Parameter	Utilisation of ¹⁴C-glucose by rhizosphere microorganisms in relation to their overall activity
Soil type	Agricultural and forest soils (pH range tested 4-7)
Plant species	maize, ryegrass, <i>Medicago</i> , Birch
System	Field and microcosm soil samples
Method	¹⁴C-glucose assay

d) **The natural abundance method** is based on the natural discrimination of ¹²C vs ¹³C or ¹⁴N vs ¹⁵N isotopes, as a result of isotope fractionation in physical, chemical and biological processes. For C, it occurs during the CO₂ assimilation by the plants. The method needs to grow C4 plants on a C3 soil or *vice versa*. The flux of organic compounds from plant origin are estimated from the $\delta^{13}\text{C}$ value of soil's organic matter pool or soil C respiration. For N, $\delta^{15}\text{N}$ can give insights into N cycle rates or give measurements of N-fixing activities.

Basic references

Balesdent, J.; Balabane, M. 1996. Major contribution of roots to soil carbon storage inferred from maize cultivated soils. *Soil Biology Biochemistry* 28: 1261-1263.

Högberg, P. 1997. ^{15}N natural abundance in soil-plant systems. *Tansley review n°95. New Phytologist* 137: 179-203

Rochette, P.; Flanagan, L.B. 1998. Quantifying rhizosphere respiration in a corn crop under field conditions. *Soil Sci. Soc. Am. J.* 61: 466-474.

Application areas

The method is mainly devoted to quantify in the field the long-term contribution of root-C to soil C. It is applicable in the field, without special equipments, as the labelling occurs naturally. The main limitation is the low temporal resolution that does not allow its use for short-term studies on rhizosphere processes.

Problems, constraints, do's and don'ts

Sample analyses require very sensitive and thus expensive mass spectrometers. Another constraint is to identify soils cropped with C3 or C4 plants for a long period (for C budget studies). There are some difficulties to interpret the variation in $\delta^{15}\text{N}$ in soil-plant systems (isotopic source effects vs fractionation).

Related method sheets

ID	32_Balesdent_b
Parameter	Root-derived carbon: amount, quality
Soil type	Any
Plant species	C4-plant in C3 environment or vice-versa
System	In the field
Method	Natural ^{13}C signature of C4 plants in the field

ID	32_Gioacchini
Parameter	Soil Total Organic Carbon and $\delta^{13}\text{C}$
Soil type	All types of soil
System	e.g. field soil, microcosm
Method	Elemental analysis and Continuous flow-isotope ratio mass spectrometry (CF-IRMS)

3.2.3. Isotope-based detection devices

Liquid scintillation and gamma counters have been widely used to detect radioactivity for years. The imaging of β -radiation by electronic auto-radioagraphy is appropriate for a wide range of radioactive isotopes, showing the pattern of element distribution from the shoots to the roots and mycorrhizal web.

Very sensitive detection devices for stable isotopes, such as Nuclear Magnetic Resonance (NMR), Gas Chromatography (GC)-Mass Spectrometry (MS), GC-Isotope Ratio MS, are now available, allowing quantitative and qualitative *in situ* analyses of the C and N composition of rhizosphere samples. This area is promising to identify and localize the root released compounds, to estimate their residence time and to assess the transfer of elements between compartments and their dynamics within a given compartment (capture of elements by microorganisms and plants from labelled patches in soil).

Basic references

Derrien, D ; Balesdent, J. ; Marol, C. ; Santaella, C. 2003. Measurement of the $^{13}\text{C}/^{12}\text{C}$ ratio of soil-plant individual sugars by gas chromatography/combustion/ isotope-ratio mass spectrometry of silylated derivatives. *Rapid Communications in Mass Spectrometry* 17: 2626-2631.

Fitter, A.H.; Graves, J.D.; Watkins, N.K.; Robinson, D.; Scrimgeour, C. 1998. Carbon transfer between plants and its control in networks of arbuscular mycorrhizas. *Functional Ecology* 12: 406-412.

Hodge, A.; Campbell, C.D.; Fitter, A.H. 2001. An arbuscular mycorrhizal fungus accelerates decomposition and acquires nitrogen directly from organic material. *Nature* 413: 297-299.

Slater, R.J. (ed.) 1990. *Radioisotopes in Biology. A practical approach.* Oxford University Press, New York, 307 pp.

Application areas

All kind of soils. Universal use of β -radiation counters and high sensitivity.

Detection of root released compounds by GC-MS can be done from adhering soil of plants grown in microcosms or field grown plants (previously labelled with ^{13}C).

Problems, constraints, do's and don'ts

The imaging of β -radiation by electronic auto-radiography is limited to upper layers of flat microcosms or rhizotrons, due to poor energy emitted from some isotopes (^{14}C). An artefact can be caused by the preferential growth of roots and mycorrhizal network near the window of the rhizotron.

Compound-specific analyses require very sensitive and therefore expensive detectors (mass spectrometers, NMR..). Non-volatile (polar) compounds need derivatization prior to GC.

Related method sheets

ID	32_Balesdent_a
Parameter	Nature and dynamics of rhizodeposited organic carbon
Soil type	any
Plant species	any
System	mesocosms (plant-soil systems transportable to the laboratory)
Method	Compound-specific stable isotope tracing

ID	32_Balesdent_b
Parameter	Root-derived carbon: amount, quality
Soil type	any
Plant species	C4-plant in C3 environment or vice-versa
System	In the field
Method	Natural ^{13}C signature of C4 plants in the field

ID	32_Dennis
Parameter	^{14}C pulse labelling and allocation imaging
Soil type	All soils
Plant species	All species
System	Rhizoboxes
Method	^{14}C pulse labelling of plant material and ^{14}C allocation imaging using storage phosphor screens

ID	32_Finlay
Parameter	Distribution of radioactive isotope tracers in the mycorrhizosphere
Soil type	acid forest soils
Plant species	Pine, Birch, Spruce
System	field soil or artificially manipulated, spatially heterogeneous substrates
Method	Electronic autoradiography of flat laboratory microcosms

ID	32_Gioacchini
Parameter	Soil Total Organic Carbon and $\delta^{13}\text{C}$
Soil type	All types of soil
System	e.g. field soil, microcosm
Method	Elemental analysis and continuous flow-isotope ratio mass spectrometry (CF-IRMS)

ID	32_Hacin
Parameter	Photosynthate partitioning to root and nodule meristems
Soil type	Plant nutrient solution
Plant species	Soybean
System	Plastic growth pouch, Split-root system (see 11_Hacin)
Method	Visualization of ^{14}C labelled root and nodule meristems by Eriochrome black staining and autoradiography

ID	32_Schweiger
Parameter	Stable C and N isotopes in mycorrhizal research
Soil type	any
Plant species	mycorrhizal
System	None specified
Method	Isotope Ratio Mass Spectrometry (IRMS)

3.2.4. Non isotope-based techniques

Genetically modified bacteria are used as biosensors to report on the incorporation of an element coming from a given compartment. The expression of reporter genes that is proportional to the availability of a substrate allows the spatial localisation and the quantification of compounds in the laboratory. Example: organic compounds released by the living roots. The reporter gene can be specific of a substrate or calibrated to a range of compounds.

It is applicable in real soils in laboratory experiments or in simplified hydroponic systems. The use of a biosensor is more suitable at the single root scale than at a large spatial scale. The relation between biosensor signal and substrate availability needs a calibration, prior to the experiments.

Basic reference

Yeomans, C.V.; Porteous, F.; Paterson, E.; Meharg, A.A.; Killham, K. 1999. Assessment of lux-marked *Pseudomonas fluorescens* for reporting on organic compounds. FEMS Microbiology Letters 176, 79-83.

Problems, constraints, do's and don'ts

Field experiments are usually not possible: the GMO are restricted to controlled, restricted areas of authorized laboratories.

In real soils, the biosensor targeted to reveal a specific compound (specificity) respond also to this compound whatever its origin.

Related method sheets

ID	32_Paterson
Parameter	C-flow from plant roots
Soil type	Sand
Plant species	Broad range
System	Microcosm
Method	Biosensor reporting

ID	32_Standing
Parameter	Carbon exudation from plant roots
Soil type	Sandy loams to clays
Plant species	Developed on <i>Triticum aestivum</i> cv. Scout (wheat)
System	Liquid batch culture, soil slurries, soil microcosms using field soils
Method	Carbon biosensing with lux-marked <i>Pseudomonas fluorescens</i>

3.2.5. Conclusion

The current development of techniques presented in this chapter represents a great potential to understand the element transfer and turn-over in the plant-soil-microbes continuum. The improvement of detection sensitivity and reliable micro-samplings in the rhizosphere are still stimulating challenges. Another challenge is to assess the element cycling and transfer in the soil food webs, the rhizosphere being a biological reactor stimulating these multiple biotic interactions in the soil.

In the case of plant C, a promising aspect is the combination of tracer and molecular approaches allowing to measure the incorporation of C into soil RNA and DNA pools (stable isotope probing: as an example, see **43_Prosser_b**). This is an elegant and pertinent way to determine the 'active' rhizosphere community, heterotroph as regard to rhizodeposited C. This is one of the steps to access rhizosphere functions.

Editor: Senesi, Nicola

Dipartimento di Biologia e Chimica Agroforestale ed Ambientale, Università di Bari, via Amendola 165/A 70126 Bari – Italy

senesi@agr.uniba.it

3.3.1. Introduction

The subject of this chapter is the current methodology used in research on “soil organic matter and organic pollutants”.

Soil organic matter (SOM) represents a heterogeneous and extremely complex system consisting of several organic compounds that widely differ in their molecular composition, structure, chemical and biological reactivity and functions exerted in soil. Because of this, the study of SOM is rarely conducted on the whole material, but separation in various fractions generally precedes any accurate study. With this regard physical, chemical and biological classification and fractionation methods have been proposed for SOM but no unanimous consensus exists on any of them.

The most commonly used and widely accepted chemical fractionation method for SOM includes the separation of nonhumic and humic fractions, and further operational fractionation of the latter fractions. The nonhumic fraction includes several molecularly defined classes of biogenic organic compounds such as polysaccharides, lipids, proteins, etc. On the contrary, humic substances consist of a physically and chemically heterogeneous mixture of an infinite number of more or less complex organic macromolecules of ill-defined molecular structure, which are originated by secondary microbial and chemical synthesis of decay products of dead plant and animal organisms in soil. According to their solubility in aqueous solution at various pHs, humic substances are commonly fractionated in three main fractions: (a) fulvic acid, the fraction

soluble at any pH value, (b) humic acid, the fraction soluble at alkaline pH and insoluble at neutral and acidic pH; (c) humin, the fraction insoluble at any pH.

Organic pollutants (OPs) that can be found in the soil system also represent an extremely wide and variable group of compounds of widely different chemical nature and behaviour. Besides pesticide residues and their various degradation products, a number of chemicals of various origin and nature may reach the soil through the common agricultural practices, the use of irrigation water and deposition from atmosphere. Mobility and transport, sorption and accumulation, chemical decomposition and biological degradation, plant uptake, and leaching to groundwater of OPs are highly dependent on their physical and chemical properties and on those of the soil in which they are.

As such the topic to be dealt with in this chapter is extremely wide and complex, and would need much more than relatively few individual methods described briefly here to be covered in all its aspects.

Furthermore, most if not all methods available in the current scientific literature on the subject refer generally to bulk soil without any distinction between the rhizosphere soil compartment and the adjacent external soil not immediately affected by the rhizosphere system. However, the methods described can be easily extended to SOM fractions and OPs in the rhizosphere soil. Nevertheless, significant quantitative and qualitative differences can be expected between the rhizosphere soil and adjacent soil in the composition structure, functionalities and reactivity of SOM fractions, and the behaviour, performances and fate of OPs.

The few methods described in this chapter and several others not described here are widely documented in the soil science literature. Some recent general basic books and reviews on SOM and OP analytical methodologies are the following:

Basic references

Ghabbour, E.A.; Davies, G. (eds.) 2003. Humic Substances: Nature's Most Versatile Materials. Taylor & Francis, New York.

Tan, K.H. 2003. Humic Matter in Soil and the Environment. Principles and Controversies, Marcel Dekker Inc..

Senesi, N.; Boddy, L. 2002. A fractal approach for interactions between soil particles and Microorganisms. In: Huang, P.M.; Bollag, J.M.; Senesi, N. (eds.) Interactions of Soil Particles and Microorganisms and their Impact on the Terrestrial Environment. IUPAC Series on Analytical and Physical Chemistry of Environmental Systems, Vol. 8, Wiley, New York, pp. 41-83.

Swift, R.S.; Spark, K.M. (eds.) 2001. Understanding and Managing Organic Matter in Soils, Sediments, and Waters. International Humic Substances Society, St. Paul, MN, USA.

Ghabbour, E.A.; Davies, G. (eds.) 2000. Humic Substances Versatile Components of Plants, Soil and Water, Royal Society of Chemistry, Cambridge.

Senesi, N. 1999. Aggregation patterns and macromolecular morphology of humic substances: a fractal approach. *Soil Sci.* 164: 841-856.

Senesi, N.; Loffredo, E. 1999. The Chemistry of Soil Organic Matter. In: Sparks, D.L. (ed.) Soil Physical Chemistry, 2nd Edit. CRC Press, Boca Raton, pp. 239-370.

Hessen, D. O.; Tranvik, L.J. (eds.) 1998. Aquatic Humic Substances--Ecology and Biogeochemistry. Springer-Verlag, Berlin.

Davies, G.; Ghabbour, E.A. (eds.) 1998. Humic Substances: Structures, Properties and Uses, Royal Society of Chemistry, Cambridge.

Hayes, M.H.B.; Wilson, W.R. (eds.) 1997. Humic Substances, Peats and Sludges. Royal Society of Chemistry, Cambridge.

Clapp, C.E.; Hayes, M.H.B.; Senesi, N.; Griffith, S.M. (eds.) 1996. Humic Substances and Organic Matter in Soil and Water Environments. International Humic Substances Society, St. Paul, MN.

Piccolo, A. (ed.) 1996. Humic Substances in Terrestrial Ecosystems. Elsevier.

Stevenson, F.J. 1994. Humus Chemistry, 2nd Ed.. Wiley, New York.

Senesi, N., Miano, T. M. (eds.) 1994. Humic Substances in the Global Environment and Implications for Human Health. Elsevier, Amsterdam.

Hayes, M.H.B.; MacCarthy, P.; Malcolm, R.L.; Swift, R.S. (eds.) 1989. Humic Substances II: In Search of Structure. Wiley-Interscience, New York.

Aiken, G.R.; McKnight, D.M.; Wershaw, R.L.; MacCarthy, P. (eds.) 1985. Humic Substances in Soil, Sediment, and Water. Wiley-Interscience, New York.

3.3.2. Physico-chemical characterization of soil organic matter fractions

Brief method description

Eight representative methods are provided on the physico-chemical characterization of organic matter fractions, mainly humic substances, which are isolated from soil and leaf litter leachates. In particular, the determinations of structural and functional groups, phenolic and organic free radical contents, low molecular weight components, metal ion complexation, acid-base properties, thermal behaviour and isotopic delta-13 C values are described by using total luminescence spectroscopy (TLS), Fourier transform infrared (FT IR) spectroscopy, surface enhanced Raman spectroscopy (SERS), electron spin (or paramagnetic) resonance (ESR or EPR) spectroscopy, ¹H nuclear magnetic resonance (¹H-NMR) spectroscopy, potentiometric titration, differential thermal analysis (DTA), differential scanning calorimetry (DSC).

Further, methods are described for extraction and fractionation from soil of fulvic and humic acids, isolation of soil solution and aqueous leaf litter leachates, preparation of samples at a fixed concentration of dissolved organic carbon (DOC) and pH, correction and interpreting of total luminescence spectra (TLS) and calculation from them of stability constants and binding capacities for organic complexes with Al and Cu.

Some basic references

Ghabbour, E.A.; Davies, G. (eds.) 2001. Humic Substances: Structures, Models and Functions, Royal Society of Chemistry, Cambridge.

Ghabbour, E.A.; Davies, G. (eds.) 1999. Understanding Humic Substances: Advanced

Methods, Properties and Uses, Royal Society of Chemistry, Cambridge, 1999.

Senesi, N. 1996. Electron spin (or paramagnetic) resonance spectroscopy. In: Sparks, D.L. (ed.) Methods of Soil Analysis: Chemical Methods. ASA-CSSA-SSSA, Publ. Madison (USA), pp. 323-356.

Related method sheets

ID	33_Luster
Parameter	Phenolics and their metal complexation ability in soil solution, leaf litter leachates and extractable soil organic matter (SOM)
Soil type	Acid Forest Soils, Vertisols
System	Field
Method	Total Luminescence Spectroscopy

ID	33_Montecchio_a
Parameter	Thermal behaviour of humic substances
Soil type	All types of soil
System	Field
Method	Differential Thermal Analysis (DTA)

ID	33_Montecchio_b
Parameter	Acid-base properties of humic substances
Soil type	Natural and cultivated soils
System	Field
Method	Potentiometric titration

ID	33_DOrazio_a
Parameter	Indigenous organic free radicals and complexed transition metal ions in humic substances (HS) in rhizospheric and adjacent soil
Soil type	Any
Plant species	Herbaceous: wheat, spring rapeseed, faba bean, tomato, artichoke. Woody: apple, olive, vine
System	Field
Method	Electron spin (or paramagnetic) resonance (ESR or EPR) Spectroscopy

ID	33_DOrazio_b
Parameter	Molecular structure of humic substances (HS) in rhizospheric and adjacent soil
Soil type	Any
Plant species	Herbaceous: wheat, spring rapeseed, faba bean, tomato, artichoke. Woody: apple, olive, vine
System	Field
Method	Fourier Transform Infrared Spectroscopy (FT-IR)

ID	33_Provenzano
Parameter	Endothermic and exothermic reactions occurring during a programmed and controlled heating of organic matter samples
Soil type	Any soil
System	Laboratory experiments
Method	Differential Scanning Calorimetry (DSC)

ID	33_Sanchez_Cortes
Parameter	Structure and functional groups of humic substances
Soil type	Any soil
System	Field
Method	Surface-Enhanced Raman Spectroscopy (SERS)

ID	33_Tugnoli
Parameter	Characterization of low molecular weight soil organic matter fraction
Soil type	Any soil
System	organic matter from soil
Method	Extraction of low molecular weight components and their identification using ¹H Nuclear Magnetic Resonance Spectroscopy (¹H NMR)

3.3.3. Phytoavailability and phytotoxicity of organic pollutants

Brief method description

Three methods are described on xenobiotic root uptake and transport by using a pressure chamber, xenobiotic uptake and phytotoxicity by willow tree transpiration test, and the determination of bioavailable and labile fractions of hydrophobic organic compounds by nonexhaustive extraction methods.

In particular, the pressure chamber technique (PCT) can identify early parameters and conditions that influence uptake and translocation into root xylem of different xenobiotic compounds without using radiolabelled tracers; willow tree transpiration test can be used as a cheap and fast method for measuring acute toxicity of chemicals and polluted soils; and two nonexhaustive extraction techniques (NEET) based on the use of cyclodextrin and hydrophobic resin extractants, can be applied for assessing bioavailability of organic compounds, especially PAHs, in soil samples and quantification by HPLC of the contaminant recovered.

Related method sheets

ID	33_Ciucani
Parameter	Xenobiotics root uptake and transport
Plant species	Soybean
System	Laboratory test with hydroponically grown plants
Method	Pressure Chamber Technique (PCT)

ID	33_Puglisi
Parameter	Bioavailable and labile fractions of hydrophobic organic compounds
Soil type	Agricultural and forest soils
System	Field soil, microcosm
Method	Non exhaustive extraction techniques (NEETs)

ID	33_Trapp
Parameter	Xenobiotics phytotoxicity
Soil type	Any kind of soil or sludge, but not too loamy and stony
Plant species	Basket willows (<i>Salix viminalis</i>) or other Salicaceae
System	Rapid laboratory test for acute toxicity to trees
Method	Willow Tree Transpiration Test

3.3.4. Retention of organic pollutants in soil

Brief method description

Three methods are presented on sorption/desorption of chlordane, triallate and some endocrine disruptor compounds to/from soils and soil humic acids by using a batch equilibrium method and gas chromatography (GC) and high performance liquid chromatography (HPLC) techniques. Methods are also described for fitting experimental adsorption data to various isotherm models and to calculate and interpret adsorption parameters.

Some basic references

Clapp, C.E.; Hayes, M.H.B.; Senesi, N.; Bloom, P.R.; Jardine, P.M. (eds.) 2001. Humic Substances and Chemical Contaminants, Soil Science Society of America, Madison, WI, USA.

Senesi, N.; Loffredo, E.; D'Orazio, V.; Brunetti, G; Miano, T.M.; La Cava, P. 2001. Adsorption of pesticides by humic acids from organic amendments and soils. In: Clapp, C.E.; Hayes, M.H.B.; Senesi, N.; Bloom, P.R.; Jardine, P.M. (eds.) Humic Substances and Chemical Contaminants. Soil Science Soc. of America, Inc., Madison, WI, pp.129-153.

Drozd, J.; Gonet, S.S.; Senesi, N.; Weber, J. (eds.) 1997. The Role of Humic Substances in the Ecosystems and in Environmental Protection. PTSH-Polish Society of Humic Substances, Wroclaw, Poland.

Related method sheets

ID	33_Loffredo_a
Parameter	Sorption of the highly persistent organochlorine insecticide chlordane to soils and soil humic acids
Soil type	Any
System	Laboratory experiments
Method	Batch equilibrium method and GC analysis

ID	33_Loffredo_b
Parameter	Adsorption/desorption of endocrine disruptor compounds (EDC) to / from soils and soil humic acids
Soil type	Any
System	Laboratory experiments
Method	Batch equilibrium method and HPLC analysis

ID	33_Loffredo_c
Parameter	Adsorption of the hydrophobic herbicide triallate to soils and soil humic acids
Soil type	Any
System	Laboratory experiments
Method	Batch equilibrium method and HPLC analysis

Editors: Schweiger, Peter¹⁾; Finlay, Roger D.²⁾

¹⁾ Institute of Soil Science, University of Natural Resources and Applied Life Sciences, Peter Jordan Straße 82, A-1190 Vienna, Austria

peter.schweiger@boku.ac.at

²⁾ Dept. Forest Mycology & Pathology, SLU, Box 7026, SE-750 07 Uppsala, Sweden

roger.finlay@mykopat.slu.se

4.1.1. Introduction

This chapter is on microbial growth and visualisation of both fungi and bacteria. Most of the contributions so far are on mycorrhizas - symbiotic associations between the vast majority of vascular plants and specific soil fungi – however several additional methods are presented for bacteria, including Visualization of the rhizoplane microflora by computer-assisted microscopy, spatial analysis by CMEIAS image analysis (**41_Dazzo**), In situ detection of bacterial gene expression in the rhizosphere (**41_Rothballer**), studies of bacterial growth using BioscreenC (**41_Vanderleyden_a**), studies of colony morphology (**41_Vanderleyden_b**) and root dilution analysis (**41_Biro**).

Smith & Read (1997) give a thorough and highly recommended general introduction to mycorrhizas. Mycorrhizal fungi are a major component of the rhizosphere microbial community. They play important roles in the nutrition and fitness of plants, they alleviate various stresses to plants, they contribute to soil nutrient cycling, soil aggregation and even soil formation. Several different types of mycorrhiza are currently known, which differ in the groups of organisms involved and also in many morphological and physiological aspects. The methods presented in this chapter exclusively deal with the two most widespread types of mycorrhiza, namely arbuscular mycorrhizas (AM) and ectomycorrhizas (EM). Biochemical and microscopical

methods are presented for the quantification of both types of mycorrhiza in field samples. These methods also comprise recommended procedures for the recovery and quantification of root-external mycorrhizal fungal structures, such as soil mycelium and AM fungal (AMF) spores. In addition to these field-related methods, some methods for the study of mycorrhizal development and morphology under controlled conditions including *in vitro* culturing are described.

There are a number of other important mycorrhiza-relevant techniques, that are either not covered by contributions in the current section or as yet not covered at all such as eg methods for the:

- morphological characterization of field-collected ectomycorrhizas (see **43_Taylor**)
- identification of mycorrhizal associates by molecular tools. This is especially important for AMF, since morphological characters of these fungi possess only limited diagnostic value.
- isolation and pure-culturing of ectomycorrhizal fungi
- methods of synthesis of ectomycorrhiza, ericoid mycorrhiza, orchid mycorrhiza – for specifically this aspect the reader is as yet referred to the relevant chapter by R.L. Peterson in “Methods in Microbiology 23 & 24. Techniques for Mycorrhizal Research,” edited by JR Norris et al..

4.1.2. Microscopy of AM: visualization and quantification

There is some limited potential for visualizing AMF structures in live, untreated roots which is described (**41_Vierheilig_b**). However, roots most often need to be cleared and stained to visualize the intraradical mycelium of AM fungi. A detailed overview of methods used for the observation of AMF structures in roots is presented by Vierheilig et al. (2005). In this Handbook of Methods, three method sheets deal with root clearing and staining (**41_Jansa_f**; **41_Vierheilig_c**) and the way root colonization is best quantified (**41_Schweiger_a**). All methods require root clearing with KOH prior to staining. Length of clearing depends on various characters such as plant species and root age and thickness. But even with prolonged clearing times with KOH sometimes not all cell wall-bound secondary metabolites will be removed. Bleaching with alkaline hydrogen peroxide effectively removes the remaining pigments in cleared roots (Brundrett et al., 1996). However, this procedure should be used cautiously because staining of fungal hyphae will be reduced and may even be eliminated. Following clearing AM fungi are stained with suitable dyes. There are a number of dyes available that give good staining quality of the fungal structures and good contrast between root and fungal material. When choosing a dye, potential health hazards should also be taken into consideration (**41_Jansa_f**; **41_Vierheilig_c**).

Following staining the percentage of root length colonised by AM fungi is determined by line intersect methods (**41_Schweiger_a**). For a more detailed description of AM root colonisation the method published by McGonigle et al. (1990) is recommended. This method allows the differentiation between root sections colonised by just hyphae or by arbuscules as well. This can be taken as a measure of the activity of the symbiosis. The proportion of root colonisation containing vesicles gives an indication of the carbon supply to the AM fungi.

For detailed morphological studies of mycorrhizal structures the use of a Laser Scanning Confocal Microscope (LSCM) can be recommended. Images of a much higher three-dimensional resolution than possible with conventional light and epifluorescent microscopical techniques can be obtained by this technique (**41_Schweiger_b**).

References

- Brundrett, M.; Bougher, N.; Dell, B.; Grave, T.; Malajczuk, N. 1996. Working with Mycorrhizas in Forestry and Agriculture. Australian Centre for International Agricultural Research Monograph 32, Canberra, 374 pp.
- Dickson, S.; Schweiger, P.; Smith, F.A.; Söderström, B.; Smith, S. 2003. Paired arbuscules in the *Arum*-type arbuscular mycorrhizal symbiosis with *Linum usitatissimum*. Canadian Journal of Botany 81: 457-463.
- Giovannetti, M.; Mosse, B. 1980. An evaluation of techniques for measuring vesicular-arbuscular infection in roots. New Phytologist 84: 489-500.
- McGonigle, T.P.; Miller, M.H.; Evans, D.G.; Fairchild, G.L.; Swan, J.A. 1990. A new method that gives an objective measure of colonization of roots by vesicular-arbuscular mycorrhizal fungi. New Phytologist 115: 495-501.
- Vierheilig, H.; Coughlan, A.P.; Wyss, U.; Piché, Y. 1998. Ink and vinegar, a simple staining technique for arbuscular- mycorrhizal fungi. Applied and Environmental Microbiology 64: 5004-5007.
- Vierheilig, H.; Knoblauch, M.; Juergensen, K.; van Bel, A.; Grundler, F.M.W.; Piché, Y. 2001. Imaging arbuscular mycorrhizal structures in living roots of *Nicotiana tabacum* by light, epifluorescence and confocal laser scanning microscopy. Canadian Journal of Botany 79: 231-237.
- Vierheilig, H.; Schweiger, P.; Brundrett, M. 2005. An overview of methods for the detection and observation of arbuscular mycorrhizal fungi in roots. Physiologia Plantarum 125: 393-404.

Related Method Sheets:

ID	41_Jansa_f
Parameter	Root colonization by arbuscular mycorrhizal fungi (AMF)
Soil type	any
Plant species	broad range of herbaceous plants, ferns and mosses (non woody)
System	field grown plants, pot cultures, monoxenic root cultures
Method	Staining of AMF colonization in roots

ID	41_Schweiger_a
Parameter	Colonisation of roots by arbuscular mycorrhizal (AM) fungi
Plant species	Most Angiosperms, many Pteridophytes, some Gymnosperms
System	Roots
Method	The gridline intersection method

ID	41_Schweiger_b
Parameter	Visualisation of ecto- and arbuscular mycorrhizal morphology
Method	Laser Scanning Confocal Microscopy (LSCM)

ID	41_Vierheilig_b
Parameter	In vivo observation of arbuscular mycorrhizal structures in intact living roots
Soil type	Any soil with few organic particles
Plant species	Rye-grass (<i>Lolium perenne</i>); tobacco
Method	Laser Scanning Confocal Microscopy (LSCM)

ID	41_Vierheilig_c
Parameter	Observation of stained arbuscular mycorrhizal structures in roots
Plant species	Any plant
Method	Staining of arbuscular mycorrhizal fungi with ink and vinegar

4.1.3 Quantification of mycorrhizas and other soil organisms by biochemical methods

As an alternative to microscopy, compounds characteristic for mycorrhizal fungi or various other soil biota may be quantified and serve as indirect measures for the biomass of the organisms of interest. These biochemical methods include the measurement of phospholipid fatty acids (PLFAs) and sterols (**41_Puglisi**). PLFA and sterol patterns may yield important information concerning the composition of soil microbial communities and allow interpretation of soil functional aspects.

For the AM symbiosis (**41_Olsson**), a specific PLFA (16:1 ω 5) can be used as a signature compound for the detection and quantification of AM fungi in roots and, with some reservations, also in soil. It is rare in other fungi but the dominant fatty acid in most AM fungi except *Gigaspora* spp. Additional information may be obtained, if also the neutral lipid fatty acids (NLFA) are included in the analysis. The ratio NLFA/PLFA may be taken as an

indication of the carbon status of the AM fungi.

For the EM symbiosis (**41_Wallander**), ergosterol has been found the most suitable compound, superior to the use of eg chitin or other PLFAs than the one used for AM fungal characterization (eg 18:2 ω 6,9). It is important to note that AM fungi contain hardly any or no ergosterol. This compound can therefore not be used as a measure of AM fungal biomass!

References

Nylund, J.-E.; Wallander, H. 1991. Ergosterol analysis as a means of quantifying mycorrhizal biomass. In: Norris, J.R.; Read, D.J.; Varma, A.K. (eds.) Methods in Microbiology 24. Academic Press, London.

Olsson, P.A.; Larsson, L.; Bago, B.; Wallander, H.; van Aarle, I.M. 2003. Ergosterol and fatty acids for biomass estimation of mycorrhizal fungi. New Phytologist 159: 5-7

Zelles, L. 1996. Fatty acids patterns of microbial phospholipids and lipopolysaccharides. In: Schinner, F.; Öhlinger, R.; Kandeler, E.; Margesin, R. (eds.) Methods in Soil Biology. Springer-Verlag, Berlin, pp 80-93.

Related Method Sheets:

ID	41_Olsson
Parameter	Quantification of AM fungal signature lipids
Soil type	Any
Method	Fatty acid analysis

ID	41_Puglisi
Parameter	Sterols, Phospholipid Fatty Acids (PLFAs)
Soil type	Agricultural and forest soils
System	microcosm
Method	Characterization of soil living and dead biomass origin and structure

ID	41_Wallander_a
Parameter	Fungal biomass
Soil type	forest soil
Plant species	pine, spruce, birch
System	field soil, microcosm
Method	Ergosterol

4.1.4. Observation and quantification of root-external mycorrhizal fungal structures

A minirhizotron system specifically developed for the observation of

ectomycorrhizal mycelia including rhizomorphs and emanating hyphae is described (**41_Blaschke**). This system can be employed in field studies for the study of eg functional attributes of EMF mycelia.

Quantitative methods in this section may be divided into those that quantify specific root-external mycorrhizal fungal structures (such as spores and mycelium) and those that give a measure of AM fungal propagules in soil, without specifying exact propagule types. The latter are important in eg the assessment of the AM root colonisation potential of soils. The described MPN (**41_Jansa_d**) and infection-unit-number (**41_Takacs_b**) methods give very precise values for the colonisation potential. They may however be too labour and material intensive for the screening of a large number of samples. In those instances, bioassays have proven very useful, where a test plant is grown in the to-be-examined substrates for a given length of time (eg 3 weeks). Root colonisation in the test plant is subsequently determined and the colonisation potential of the substrates is ranked according to the measured root colonisation.

Two methods (**41_Jansa_c**; **41_Wallander_b**) describe the quantification of external mycelium of mycorrhizal fungi. The method for EM fungi by Wallander additionally allows the quantification of mycelium production on field sites. Quantification of external AM mycelium is to some extent dependent on the texture of the soil. For very loamy soils, it may prove necessary to incubate the soil in a dilute solution of a detergent (most often hexametaphosphate) prior to washing it onto sieves.

The spores produced by AM fungi are some of the biggest fungal spores and therefore, once separated from the soil, quite easy to observe at low magnification under a dissecting microscope. A method describes the extraction of spores from soil (**41_Jansa_b**). It may be added that if spores should be retrieved from dry soil, the soil is best left for half an hour to soak in water. Thereby the dehydrated spores rehydrate and can subsequently be extracted by the described method.

References

- Abbott, L.K.; Robson, A.D.; De Boer, G. 1984. The effect of phosphorus on the formation of hyphae in soil by the vesicular-arbuscular mycorrhizal fungus *Glomus fasciculatum*. *New Phytologist* 97: 437-446.
- Adelman, M.J.; Morton, J.B. 1986. Infectivity of vesicular-arbuscular mycorrhizal fungi: Influence of host-soil diluent combinations on MPN estimates and percentage colonization. *Soil Biology & Biochemistry* 18: 7-13.
- Franson, R.L.; Bethlenfalvay, G.J. 1989. Infection unit method of vesicular-arbuscular mycorrhizal propagule determination. *Soil Science Society of America Journal* 53:754-756.
- Pacioni, G. 1994. Wet-sieving and Decanting Techniques for the Extraction of Spores of Vesicular-arbuscular Fungi. In: Norris, J.R.; Read, D.; Varma, A.K. (eds.) *Techniques for Mycorrhizal Research - Methods in Microbiology*. Academic Press Inc., San Diego, CA.
- Wallander, H.; Nilsson, L.-O.; Hagerberg, D.; Bååth, E. 2001. Estimation of the biomass and seasonal growth of external mycelium of ectomycorrhizal fungi in the field. *New Phytologist* 151: 753-760.

Related Method Sheets:

ID	41_Blaschke
Parameter	Ectomycorrhiza: exploration types, hyphal network, rhizomorphs, and their response to chemical and physical properties of the soil environment
Soil type	forest soil, organic litter layer
Plant species	Conifers and hardwoods (eg <i>Picea abies</i> , <i>Fagus sylvatica</i>)
System	microcosm
Method	Slim cases for digital recording of ectomycorrhiza formation <i>in situ</i>

ID	41_Jansa_b
Parameter	Arbuscular mycorrhizal fungal (AMF) spores
Soil type	acid to moderately alkaline field soils with moderate SOM and clay contents
Plant species	various grasses, cereals, legumes, grassland plants
System	field soil, soil-sand mixtures
Method	Extraction of AMF spores from soil

ID	41_Jansa_c
Parameter	Arbuscular mycorrhizal fungal (AMF) mycelium
Soil type	soil-sand mixture (potting substrate for AMF experiments), sandy soils
Plant species	any
System	pot experiments, field soil
Method	Assessment of AMF mycelium length density in soil

ID	41_Jansa_d
Parameter	Arbuscular mycorrhizal fungal (AMF) infectivity
Soil type	any soil
Plant species	any natural vegetation; maize, leek, sunflower, plantain, flax and other plant species as test plants
System	biotest pots
Method	Estimation of infectious potential of AMF in soil/inoculum

ID	41_Takacs_b
Parameter	Quality control of Arbuscular Mycorrhizal Fungi inoculum
Soil type	any
Plant species	AMF host plants
System	plant root system
Method	Quantification of mycorrhizal propagules density

ID	41_Wallander_b
Parameter	Production of external ectomycorrhizal mycelia in the field
Soil type	acid forest soil, sand-dune soil
Plant species	pine, spruce, grass
System	field soil
Method	In-growth mesh bags

4.1.5. Arbuscular mycorrhizal fungal isolation and pure culture

Two quite similar methods are presented for the isolation and pure culturing of AM fungi (**41_Takacs_a**; **41_Jansa_a**). Both methods can be taken as the starting point if AM fungi should be established in monoxenic cultures (**41_Jansa_e**). This procedure can not be considered as an easy method and researchers wanting to start work with monoxenic AM cultures are advised to consider approaching colleagues for possible supply of a starter culture.

References

Brundrett, M.; Abbott, L.K.; Jasper, D.A. 1999. Glomalean mycorrhizal fungi from tropical Australia. I. Comparison of the effectiveness and specificity of different isolation procedures. *Mycorrhiza* 8: 305-314.

Fortin, J.A.; Becard, G.; Declerck, S.; Dalpe, Y.; St-Arnaud, M.; Coughlan, A.P.; Piché, Y. 2002. Arbuscular mycorrhiza on root-organ cultures. *Canadian Journal of Botany* 80: 1-20.

Related Method Sheets:

ID	41_Jansa_a
Parameter	Isolation and culturing of arbuscular mycorrhizal fungi (AMF)
Soil type	any
Plant species	any plant possible to grow from seed/cutting under greenhouse conditions
System	pots
Method	Establishment and maintenance of monospecific AMF cultures

ID	41_Jansa_e
Parameter	monoxenic arbuscular mycorrhizal fungal (AMF) cultures
Plant species	carrot, <i>Medicago truncatula</i> , tomato
System	in-vitro culture
Method	Establishment and maintenance of monoxenic AMF cultures

ID	41_Takacs_a
Parameter	Single spore inoculum production of Arbuscular Mycorrhizal Fungi
Soil type	Sterilised, γ - irradiated soil (25 kGy kg ⁻¹ dry soil) and sand mixture
Plant species	Several "trap-plant" species with a known susceptibility to AMF colonisation, such as <i>Plantago lanceolata</i> , <i>Linum usitatissimum</i> , or white clover (<i>Trifolium repens</i>)
System	Pot culture
Method	Single Spore Culture

4.1.6. Other methods

A method is described for the collection of root exudates (**41_Vierheilig_a**). These can subsequently be tested as to their effect on various life history aspects of different organisms. In addition, 41_Kohler describe a protocol for synthesizing ectomycorrhizas

References

Steinkellner, S.; Mammeler, R.; Vierheilig, H. 2005. Microconidia germination of the tomato pathogen *Fusarium oxysporum* in the presence of root exudates. *Journal of Plant Interactions* 1: 23-30.

Related Method Sheets:

ID	41_Kohler
Parameter	Synthesis of ectomycorrhiza
Plant species	Poplar
System	Artificial growth media in Erlenmeyer flasks
Method	Culture in perlite

ID	41_Vierheilig_a
Parameter	Collection of root exudates of plants colonized and non-colonized by arbuscular mycorrhizal fungi
Soil type	Any soil with few organic particles (hard to wash off the roots)
Plant species	Any plant
Method	Root washing with distilled water

4.1.7. Further References on Mycorrhiza

Norris, J.R.; Read, D.; Varma, A.K. (eds.) 1994. Methods in Microbiology 23 & 24. Techniques for Mycorrhizal Research. Academic Press Inc., London, San Diego, CA.

Schenck, N.C. (ed.) 1982. Methods and Principles of Mycorrhizal Research. The American Phytopathological Society, St. Paul.

Smith, S.E.; Read, D.J. 1997. Mycorrhizal symbiosis. Academic Press, London, San Diego.

Varma, A.; Hock, B. (eds.) 1998. Mycorrhiza. Structure, function, molecular biology and biotechnology. Springer-Verlag, Berlin.

4.1.7. Bacteria

References

Dazzo, F.B.; Joseph, A.R.; Gomaa, A.B.; Yanni, Y.G.; Robertson, G.P. 2003. Quantitative indices for the autecological biogeography of a Rhizobium endophyte of rice at macro and micro spatial scales. Symbiosis 35: 147-158.

Dazzo, F.B. 2004. Applications of quantitative microscopy in studies of plant surface microbiology. In: A Varma et al. (eds.). Plant Surface Microbiology. Springer-Verlag, Germany, pp. 503-550

Dazzo, F.B.; Schmid, M.; Hartmann, A. 2006. Use of immunofluorescence microscopy and Fluorescence In Situ Hybridization combined with advanced image analysis software tools to study the autecology of soil- and plant-associated microbes. In: Lipson, D. et al. (eds.). Manual of Environmental Microbiology, 3rd edition, American Society for Microbiology Press, Washington, DC, in press.

Jansson, J.K. 2003. Marker and reporter genes: illuminating tools for environmental microbiologists. Current Opinion in Microbiology 6: 310-316.

Liu, J.; Dazzo, F.B.; Glagoleva, O.; Yu, B.; Jain, A.K. 2001. CMEIAS: a computer-aided system for the image analysis of bacterial morphotypes in microbial communities. Microb. Ecol. 41: 173-194.

Related Method Sheets

ID	41_Biro
Parameter	Bacterial numbers
Soil type	any
Plant species	any
System	plant root system
Method	Root dilution analysis

ID	41_Dazzo
Parameter	Patterns of Spatial Distribution of the Pioneer Rhizoplane Microflora
Soil type	light textured soils
Plant species	White Clover (<i>Trifolium repens</i> L.)
System	Young seedlings growing in light textured soil
Method	Visualization of the rhizoplane microflora by computer-assisted microscopy, spatial analysis by CMEIAS image analysis

ID	41_Dennis_a
Parameter	Non-destructive sampling of bacteria
Soil type	All soils
Plant species	Validated with <i>Brassica napus</i>
System	Rhizoboxes
Method	Non-destructive micro-scale sampling of bacteria from a root surface using a tungsten rod with a standardised sampling area controlled by a micromanipulator

ID	41_Dennis_b
Parameter	Visualisation of rhizosphere bacterial colonisation patterns
Soil type	All soils
Plant species	All plants
System	Rhizoboxes
Method	CCD imaging of rhizosphere colonisation patterns of <i>Pseudomonas fluorescens</i> SBW25 luxCDABE from soil

ID	41_Rothballer
Parameter	<i>In situ</i> detection of bacterial gene expression in the rhizosphere
Plant species	cereals, tomato
System	monoxenic quartz sand system
Method	translational promoter fusion

ID	41_Vanderleyden_a
Parameter	Study of bacterial growth over a long period of time
System	Laboratory test with cultivated bacteria
Method	BioscreenC

ID	41_Vanderleyden_b
Parameter	Study of colony morphology
System	Laboratory test with cultivated bacteria
Method	Evaluation of colonies on plate

Editor: Jones, Davod L.

School of Agricultural & Forest Science, University of Wales, Bangor,
Gwynedd, LL57 2UW, UK

d.jones@bangor.ac.uk

4.2.1. Introduction

This chapter deals primarily with biochemical methods which are used to determine microbial activity and substrate concentrations in the rhizosphere. In recent years, great advances have been made in soil microbial ecology allowing not just the biochemical characteristics of soils to be determined, such as, enzyme activity, but also the size, activity and community structure of the rhizosphere microbial population. When investigating biological activity in the rhizosphere it is advisable to adopt a multifaceted approach. Typically this will involve a basic measure of soil microbial biomass and microbial activity, usually basal or substrate induced respiration alongside standard measures of key soil enzymes involved in carbon, nitrogen and phosphorus cycling such as protease, deaminase, cellulase and phosphatase. The methods for measuring most of these key soil indicator qualities are presented in this chapter of the handbook. In addition, many of these techniques outlined in this COST 631 methods handbook are reasonably straightforward and can be performed easily in most laboratories. In contrast, measures of soil microbial community structure often require specialist equipment.

Typically rhizosphere biological activity is determined in destructively sampled rhizosphere soil, however, this typically provides little spatial or temporal resolution (see **Chapter 1.3**). This may be especially important considering that typically only 10% of the rhizoplane is colonized and that where colonization does occur it can be highly dependent upon root architecture, such as cell junctions and the endorhizosphere. However, new

techniques are now available which allow microbial activity and biomass of specific species to be determined *in situ* and *in vivo* (Deweger et al., 1991; (Egener et al., 1998); Tombolini et al., 1999; see **Chapters 3.2** and **4.1** for further details). Further, the spatial and temporal dynamics can also be determined with high accuracy although experiments are typically conducted in small microcosms and can only be performed in the laboratory.

There are now a variety of *in situ* non-destructive techniques for looking at the distribution of compounds, enzymes and biological activity in the rhizosphere. In the case of soil enzymes and organic compounds free in solution, soil solution samplers have been designed to be able to sample gross rhizosphere solution. These are simply micro-versions of those used to sample bulk soil solution and can be obtained in either ceramic, polysulfone or other organic materials (Göttlein et al., 1996; Farley and Fitter, 1999). While these do allow an estimate of rhizosphere solution biochemistry to be made, the sphere of sampling is often unknown, they only operate in moist soils (<0.1 MPa) and they only recover small sample volumes.

The overlaying of agar or filter papers impregnated with colorimetric indicators on to exposed roots have also been widely employed for determining rhizosphere enzyme activities. This technique is ideal for semi-quantitative studies in which spatial dynamics are particularly important for example where distinguishing effects of the root tip, root hair zone and root base. If the colorimetric indicators are non-rhizotoxic then multiple exposures can be performed over time, however, in most cases only single time point measurements have been recorded. This

technique has been used widely for determining the spatial localization of enzymes such as phosphatases and reductases in the rhizosphere and especially in response to changes in nitrogen and phosphorus nutrition and soil acidity (Dinkelaker et al., 1993a; Dinkelaker et al., 1993b).

In addition to the method sheets presented here in this section, readers may also wish to consult other sections of the handbook and Alef and Nannipieri (1995) which also presents many detailed methods many of which are relevant to rhizosphere studies. The following methods are covered in this chapter:

- Methods for measuring soil microbial biomass and activity in soil.
- Methods for measuring enzymatic activity in soil
- Methods for measuring N transformation in soil
- Biochemical methods for hormone, protein and isoenzyme analysis in roots

Basic References

Alef, K.; Nannipieri, P. 1995. Methods in Applied Soil Microbiology and Biochemistry. Academic Press, London, 512 pp.

Deweger, L.A.; Dunbar, P.; Mahafee, W.F.; Lugtenberg, B.J.J.; Saylor, G.S. 1991. Use of bioluminescence markers to detect *Pseudomonas* spp in the rhizosphere. Appl. Environ. Microbiol. 57: 3641-3644.

Dinkelaker, B.; Hahn, G.; Römheld, V.; Wolf, G.A.; Marschner, H. 1993a. Nondestructive methods for demonstrating chemical-changes in the rhizosphere .1. Description of methods. Plant and Soil 156: 67-70.

Dinkelaker, B.; Hahn, G.; Marschner, H. 1993b. Nondestructive methods for demonstrating chemical-changes in the rhizosphere .2. Application of methods. Plant and Soil 156: 71-74.

Egener, T.; Hurek, T.; Hurek, R.B. 1998. Use of green fluorescent protein to detect expression of nif genes of *Azoarcus* sp. BH72, a grass-associated diazotroph, on rice roots. Molec. Plant Microbe Interac. 11: 71-75.

Farley, R.A.; Fitter, A.H. 1999. Temporal and spatial variation in soil resources in a deciduous woodland. J. Ecol. 87: 688-696.

Gottlein, A.; Hell, U.; Blasek, R. 1996. A system for microscale tensiometry and lysimetry. Geoderma 69: 147-156.

Tombolini, R.; vanderGaag, D.J.; Gerhardson, B.; Jansson, J.K. 1999. Colonization pattern of the biocontrol strain *Pseudomonas chlororaphis* MA 342 on barley seeds visualized by using green fluorescent protein. Appl. Environ. Microbiol. 65: 3674-3680.

4.2.2. Methods for measuring soil microbial biomass and activity in the rhizosphere

It is known that microbial population generally increase in the rhizosphere in response to the enhanced supply of carbon into the soil from root exudation. Measurement of the increase in microbial biomass, community structure and activity can be done in a range of ways. This chapter deals with simple biochemical procedures to measure total activity and biomass. For methods to identify changes in the biomass and activity of individuals species readers should consult **chapters 4.1, 4.3 and 4.4**. The methods presented here largely represent techniques that have been developed for bulk soil and which have been adapted for use in rhizosphere studies. The most frequently used method to measure soil microbial biomass in soil is the chloroform fumigation-extraction (CFE) procedure originally developed by David Jenkinson and Phil Brookes at Rothamsted, UK This CFE method has been more commonly used due to its simplicity and applicability for wide group of soils. This technique is theoretically based on the quantitative extraction of a particular compound, found in all components of the microbial community but in no other constituents of soil. Furthermore, various organic forms such as soluble free sugars, carbohydrates and proteins can be measured in the same extracts (DeLuca and Keeney, 1993b; DeLuca, 1998; Joergensen et al., 1996). Typically, as in the methods presented here (**42_Friedel** and **42_GilSotres_c**) the microbial cells are ruptured by exposure to chloroform vapours. The soil is then extracted with 0.5 M K_2SO_4 to extract the compounds released from the microbial biomass. A similar extract is then performed with the un-fumigated soil to account for the compounds naturally present in the soil but not inside the biomass. A concentrated (1 or 2 M) NaCl or KCl solution can also

be used as an extractant in place of 0.5 M K_2SO_4 (DL Jones, unpublished). The 0.5 M K_2SO_4 extracts are subsequently analysed for carbon and nitrogen compounds. In some cases total C and N are determined on a standard analyser (e.g. Shimadzu Corp. TOC and TON analyser). Alternatively, digestion methods twinned a colorimetric autoanalyser procedure can be used to estimate total C and N in the extracts (**42_GilSotres_c**). One of the commonest methods is to analyse the extracts for compounds which react with ninhydrin. Ninhydrin is a reagent which forms a purple complex with varying molecules containing amino nitrogen (e.g. ammonium, free amino acids, peptides and proteins; Moore and Stein, 1948). This can be used as a simple and reliable measure in microbial biomass determinations (Joergensen and Brookes 1990). One major drawback of this approach is that the chloroform also extracts lots of carbon and nitrogen from inside plant roots (and possibly recently added organic materials e.g. plant residues). Therefore the assay must be performed in the absence of roots to obtain a meaningful result. As the microbial population is probably greatest on the rhizoplane this poses a major drawback of the technique as this population cannot be quantified (as it is impossible to physically separate rhizoplane organisms from the root). Another drawback is that the extraction procedure is not 100% efficient and consequently a correction factor has to be used to calculate the actual biomass in the soil. This correction factor (K_{en}) is soil dependent (Joergensen and Mueller, 1996) although most researchers do not really account for this.

The other two methods presented here also represent techniques that have been developed for bulk soil and which have been adapted for use in rhizosphere studies. In the case of the method for measuring soil respiration (**42_GilSotres_e**) this technique provides an estimate of total biological activity in the rhizosphere. The measurements will measure respiration derived from both roots and soil organisms. Although methods have been devised for separating

microbial and soil respiration these are frequently technically challenging and most remain to be validated (Kuzyakov, 2006). Due to the high rate of CO_2 diffusion in soil (many cm in a minute) it is largely impossible to reliably estimate the spatial sites of CO_2 efflux with any certainty. Measurement of CO_2 evolution can be made using alkali traps and with subsequent titrations (as in **42_GilSotres_e**) and also using infra-red gas analysers (IRGA) and gas chromatographs. Examples of IRGAs are those made by PP Systems Ltd, Licor Corp, Nordgren Instruments etc). Most gas chromatographs (GCs) can be adapted for CO_2 determination. The benefit of an IRGA approach is that measurements of CO_2 evolution are continuous whilst those made with alkali traps and GCs are usually static. The benefit of the alkali trap approach is that it is easy and cheap. Another method for measuring soil microbial activity in soil is the measurement of ATP in the microbial cells (**42_GilSotres_b**). The method presented offers one way of approaching this in a standard way although modifications to the procedure have also been made recently (Wen et al., 2005). Although this technique has been used widely in soil due to its high sensitivity it suffers from problems in separating ATP present in roots and that in soil. This makes ATP determination in the entire rhizosphere impossible for the reasons mentioned earlier (e.g. quantification of ATP in rhizoplane microorganisms). If a mesh based approach is used to separate soil and plant roots (Chapter 1.1) then this potential drawback may be overcome.

Basic references

- DeLuca, T.H.; Keeney, D.R. 1993b. Soluble antrone reactive carbon in soils; effect of carbon and nitrogen amendments. *Soil Science Society of America Journal* 57: 1296-1300.
- DeLuca, T.H. 1998. Relationship of 0.5 M K_2SO_4 extractable antrone reactive carbon to indices of microbial activity in forest soils. *Soil Biology and Biochemistry*. 30: 1293-1299.
- Jenkinson, D.S.; Ladd, J.M. 1981. Microbial biomass in soil: measurement and turnover. In: Paul, E.A.; Ladd, J.N (eds.) *Soil Biochemistry*, vol 5. Marcel Dekker, New York, pp. 415-471.

Jenkinson, D.S. 1988. The determination of microbial biomass C and nitrogen in soil. In: Wilson, J.R. (ed.) *Advances in nitrogen cycling in agricultural ecosystems*. CAB International, Wallingford, pp. 368-386.

Joergensen, R.G.; Brookes, P.C. 1990. Ninhydrin reactive nitrogen measurements of microbial biomass in 0.5 M K₂SO₄ soil extracts. *Soil Biology and Biochemistry* 22: 1023-1027.

Kuzyakov, Y. 2006. Sources of CO₂ efflux from soil and review of partitioning methods. *Soil Biology and Biochemistry* 38: 425-448.

Joergensen, R.G.; Mueller, T. 1996. The fumigation-extraction method to estimate soil microbial biomass: calibration of the k_{EN} value. *Soil Biology and Biochemistry* 28: 33-37.

Moore, S.; Stein, W.H. 1948. Photometric ninhydrin method for use in chromatography of amino acids. *J. Biol. Chem.* 243: 6281-6283

Wen, G.; Voroney, R.P.; Curtin, D.; Schoenau, J.J.; Qian, P.Y.; Inanaga, S. 2005. Modification and application of a soil ATP determination method. *Soil Biology and Biochemistry* 37: 1999-2006.

Related methods sheets

ID	42_Friedel_b
Parameter	Soil microbial biomass C and N
Soil type	arable soils
Plant species	crops
System	rhizobox
Method	Chloroform fumigation extraction

ID	42_Gil_Sotres_b
Parameter	ATP content
Soil type	All soil types
System	Laboratory
Method	Luciferine-luciferase reaction

ID	42_Gil_Sotres_c
Parameter	Microbial biomass C and N
Soil type	All soil types
System	Laboratory
Method	Fumigation-extraction

ID	42_Gil_Sotres_e
Parameter	Soil respiration
Soil type	All soil types
System	Laboratory
Method	Static incubations

4.2.3. Methods for measuring enzymatic activity in soil

As most organic matter entering soil is either insoluble or of high molecular weight it must be broken down to its constituent units before being taken up by the soil microbial community. This is achieved by

enzymes released into the soil solution or attached to the surface of soil microorganisms or soil minerals. In many cases the enzymes are present in the mucilage layer surrounding the microorganisms in soil. Some enzymes are used as general indicators of soil microbial activity and these enzymes may be present inside the cell or on the cell surface (e.g. dehydrogenase). Total soil microbial activity is often highly correlated with enzyme activity in soil. Similarly, microbial biomass and enzyme activities are also often closely related. Enzymes may also be used as an indicator of soil biodiversity (Caldwell, 2005). For an in-depth view of soil enzymes readers should consult Burns and Dick (2002). Most of the procedures for estimating enzyme activity in the rhizosphere are adaptations of previous protocols designed for measuring enzyme activity in bulk soil. Enzymes are released both by the root and from the soil microbial community. The enzymes frequently assayed include those involved in general microbial activity (e.g. dehydrogenase, catalase; **42_Villnyi**, **42_Trasar_Cepada_e**, **42_Trasar_Cepada_g**), those involved in carbon cycling (e.g. glucosidase, invertase, cellulase; **42_TraserCepada_a**; **42_Trasar_Cepada_f**; **42_Trasar_Cepada_h**), those involved in nitrogen cycling (amidase, protease, urease; **42_Trasar_Cepada_c**, **42_Trasar_Cepada_d**, **42_Trasar_Cepada_k**), phosphorus cycling (acid and alkaline phosphatase, phytase; **42_Neumann**; **42_Trasar_Cepada_i**, **42_Trasar_Cepada_j**) and sulphur cycling (arylsulfatase; **42_Trasar_Cepada_b**). The most frequently used methods are included in this chapter. Typically, these methods rely on a measurement of either substrate disappearance or product appearance. Some of the enzyme methods can be performed *in situ* (e.g. **42_Neumann**, **42_Pritsch**; Dinkelaker et al., 1993ab), however, in most cases the assays are performed on soil removed from around the root. This soil removal process itself has complications in that not all the soil can be easily recovered and that root damage may lead to a large loss of enzymes from within the root leading to overestimation of rhizosphere enzymatic

cleavage rates. On the positive side, the techniques are all relatively straightforward to perform. Most rely on the UV or colorimetric assay of the enzyme reaction whilst others rely on fluorescent detection (**42_Pritsch**). Some of the major issues associated with enzymatic assays are the choice of substrates. For example, when assessing protease activity in the rhizosphere, animal proteins such as casein or bovine serum albumin (BSA) are often used as substrates. These may not reflect proteins naturally present in the field (e.g. their size, composition, structure, solubility, metal complexation and sorption properties may be different) and thus the cleavage rates only provide an indicator of activity in the rhizosphere. Another critical choice is whether to run the assays in the presence of a pH buffer when maximum enzymatic cleavage rates may be observed (e.g. **42_Trasar_Cepeda_b**) or whether to run the assays under pH conditions reflecting those naturally present in the soil. In the latter case the enzymatic cleavage rates may be significantly lower than in the presence of pH buffer. Another consideration is the choice of substrate concentration added to the soil. In many cases, the amount of substrate added to the soil will be sufficient to saturate enzyme activity giving a maximum potential for substrate cleavage. However, these concentrations may be thousands of times greater than naturally occur in the soil and care should be taken when extrapolating from rates under optimal conditions to those operating in the rhizosphere.

Basic references

Burns, R.G.; Dick, R.P. 2002. Enzymes in the Environment: Activity, Ecology and Applications. Marcel Dekker Ltd, New York, 640 pp.

Caldwell, B.A. 2005. Enzyme activities as a component of soil biodiversity: A review. *Pedobiologia* 49: 637-644.

Dinkelaker, B.; Hahn, G.; Römheld, V.; Wolf, G.A.; Marschner, H. 1993a. Nondestructive methods for demonstrating chemical-changes in the rhizosphere. 1. Description of methods. *Plant and Soil* 156: 67-70.

Dinkelaker, B.; Hahn, G.; Marschner, H. 1993b. Nondestructive methods for demonstrating chemical-changes in the rhizosphere. 2. Application of methods. *Plant and Soil* 156: 71-74.

Related method sheets

ID	42_Friedel_a
Parameter	Arginine ammonification
Soil type	arable soils
Plant species	crops
Method	Deamination of arginine incubated with soil

ID	42_Neumann
Parameter	Quantitative determination of acid phosphatase activity in the rhizosphere and on the root surface
Soil type	All soils
Plant species	All species
System	Hydroponics, Soil culture
Method	Spectrophotometric assay

ID	42_Pritsch
Parameter	Potential enzymatic activities
Plant species	any species
System	(mycorrhizal) root tips
Method	Fluorescence microplate assay for detection of enzyme activities on single (mycorrhizal) roots

ID	42_Trasar_Cepeda_a
Parameter	β-glucosidase activity
Soil type	All soil types
System	Laboratory
Method	Hydrolysis of <i>p</i>-nitrophenyl-β-D-glucopyranoside

ID	42_Trasar_Cepeda_b
Parameter	Arylsulphatase activity
Soil type	All soil types
System	Laboratory
Method	Hydrolysis of <i>p</i>-nitrophenyl sulphate

ID	42_Trasar_Cepeda_c
Parameter	BAA-protease activity
Soil type	All soil types
System	Laboratory
Method	Hydrolysis of <i>N</i>-benzoyl L-arginine amide (BAA)

ID	42_Trasar_Cepeda_d
Parameter	Casein-protease activity
Soil type	All soil types
System	Laboratory
Method	Hydrolysis of casein

ID	42_Trasar_Cepeda_e
Parameter	Catalase activity
Soil type	All soil types
System	Laboratory
Method	Decomposition of hydrogen peroxide

ID	42_Trasar_Cepeda_f
Parameter	CM-cellulase activity
Soil type	All soil types
System	Laboratory
Method	Hydrolysis of carboximethyl-cellulose

ID	42_Trasar_Cepeda_g
Parameter	Dehydrogenase activity
Soil type	All soil types
System	Laboratory
Method	Reduction of INT to INTF

ID	42_Trasar_Cepeda_h
Parameter	Invertase activity
Soil type	All soil types
System	Laboratory
Method	Hydrolysis of saccharose

ID	42_Trasar_Cepeda_i
Parameter	Phosphodiesterase activity
Soil type	All soil types
System	Laboratory
Method	Hydrolysis of bis-<i>p</i>-nitrophenyl-phosphate

ID	42_Trasar_Cepeda_j
Parameter	Phosphomonoesterase activity
Soil type	All soil types
System	Laboratory
Method	Hydrolysis of <i>p</i>-nitrophenyl-phosphate

ID	42_Trasar_Cepeda_k
Parameter	Urease activity
Soil type	All soil types
System	Laboratory
Method	Hydrolysis of urea

ID	42_Villnyi
Parameter	Total catabolic enzyme activity of microbial communities
Soil type	Any soil
Plant species	All plants
Method	Fluorescein Diacetate Analysis (FDA)

4.2.4. Methods for measuring N transformation in soil

Nitrogen is typically rate limiting to plant growth in most soils. There is also evidence to suggest that microorganisms in the rhizosphere may also be N limited. Not surprisingly there have been many methods to determine N dynamics in soil. Most of these methods reflect adaptation of techniques designed for assessment of N cycling in the bulk soil. In general the N

flow in soil follows the examples shown below:

- Protein → peptides → amino acids → $\text{NH}_4^+ \rightarrow \text{NO}_2^- \rightarrow \text{NO}_3^- \rightarrow \text{NO}_x$
- Urea → $\text{NH}_4^+ \rightarrow \text{NO}_2^- \rightarrow \text{NO}_3^- \rightarrow \text{NO}_x$
- Chitin → Amino sugars → $\text{NH}_4^+ \rightarrow \text{NO}_2^- \rightarrow \text{NO}_3^- \rightarrow \text{NO}_x$

Due to the rapid rate of NO_2^- conversion to NO_3^- , nitrate is rarely quantified in soil. An assessment of the total amount of inorganic N production can be performed using a range of incubation techniques including those performed under anaerobic conditions (**42_Friedel_c**) or aerobic conditions (**42_Gil_Sotres_d**). Normally these require that soil is removed from the roots prior to performing the assay. This is obviously a major drawback for the reasons discussed above in **chapters 4.2.2.** and **4.2.3.** On the positive side the assays are relatively straightforward to perform if the equipment is available to assay NO_3^- and NH_4^+ concentrations in soil extracts. Another approach is to assay specific components of the soil N cycle. This is shown here in the chapters assessing the enzymatic cleavage of organic high molecular weight nitrogen substrates (e.g. proteins, **42_Trasar_Cepeda_c** and **42_Trasar_Cepeda_d**). The advantages and disadvantages of these techniques are described above. In addition, the conversion of an amino acid rich in N (arginine) has also been used to assess N mineralization rates in soil (**42_Friedel_a** and **42_Gil_Sotres_a**). This technique relies on the addition of a large amount of organic N to the soil. As the C:N ratio of arginine is significantly lower than that of the microbial biomass it leads to the net excretion of excess NH_4^+ into the soil. The amount of NH_4^+ production is then measured. In some cases the increase in NO_3^- should also be measured. This method provides a qualitative indicator of mineralization potential in the rhizosphere. The measurement of urea mineralization in soil is similar to that for arginine relying on the accumulation of NH_4^+ in the soil (**42_Trasar_Cepeda_k**).

General references

Landi, L.; Valori, F.; Ascher, J.; et al. 2006. Root exudate effects on the bacterial communities, CO₂ evolution, nitrogen transformations and ATP content of rhizosphere and bulk soils. *Soil Biology & Biochemistry* 38: 509-516.

Jones, D.L.; Kemmitt, S.J.; Wright, D. et al. 2005. Rapid intrinsic rates of amino acid biodegradation in soils are unaffected by agricultural management strategy. *Soil Biology & Biochemistry* 37: 1267-1275.

Yang, Y.; Chen, Y.X.; Tian, G.M.; et al. 2005. Microbial activity related to N cycling in the rhizosphere of maize stressed by heavy metals. *Journal of Environmental Sciences* 17: 448-451.

Burger, M.; Jackson, L.E. 2004. Plant and microbial nitrogen use and turnover: Rapid conversion of nitrate to ammonium in soil with roots. *Plant and Soil* 266: 289-301.

Nielsen, T.H.; Bonde, T.A.; Sorensen, J. 1998. Significance of microbial urea turnover in N cycling of three Danish agricultural soils. *FEMS Microbiology Ecology* 25: 147-157.

Griffiths, B.S. 1994. Microbial-feeding nematodes and protozoa in soil - their effects on microbial activity and nitrogen mineralization in decomposition hotspots and the rhizosphere. *Plant and Soil* 164: 25-33.

Related method sheets

ID	42_Friedel_a
Parameter	Arginine ammonification
Soil type	arable soils
Plant species	arable crops
Method	Deamination of arginine incubated with soil

ID	42_Friedel_c
Parameter	Nitrogen mineralisation
Soil type	arable soils
Plant species	arable crops
Method	Nitrogen mineralisation by anaerobic incubation

ID	42_Gil_Sotres_a
Parameter	Arginine ammonification rate
Soil type	All soil types
System	Laboratory
Method	Static soil incubation

ID	42_Gil_Sotres_d
Parameter	N-mineralisation potential
Soil type	All soil types
System	Laboratory
Method	Static incubation

ID	42_Trasar_Cepeda_c
Parameter	BAA-protease activity
Soil type	All soil types
System	Laboratory
Method	Hydrolysis of N-benzoyl L-arginine amide (BAA)

ID	42_Trasar_Cepeda_d
Parameter	Casein-protease activity
Soil type	All soil types
System	Laboratory
Method	Hydrolysis of casein

ID	42_Trasar_Cepeda_k
Parameter	Urease activity
Soil type	All soil types
System	Laboratory
Method	Hydrolysis of urea

Editor: Finlay, Roger D.

Dept. Forest Mycology & Pathology, SLU, Box 7026, SE-750 07 Uppsala,
Sweden

roger.finlay@mykopat.slu.se

4.3.1. Introduction

This chapter deals primarily with molecular methods which are used to detect and identify individual species and to profile soil microbial communities. During the last decade there has been a shift in focus from isolation based approaches involving classical methods such as morphological characterisation and newer methods based on antibodies, chemical markers or substrate utilisation patterns, to more modern, cultivation-independent methods, largely based upon the analysis of nucleic acids. The following methods are covered in this chapter:

- Microscopy and anatomy based methods including morphological and anatomical characterisation of ectomycorrhizal roots and microscopic analysis of microconidia germination in root exudates.
- DNA and RNA extraction methods, including extraction, purification and quantification
- Amplification and analysis of extracted nucleic acids including PCR, RFLP, cloning and sequencing methods
- Microbial community fingerprinting techniques, including DGGE, TGGE, SSCP and T-RFLP
- Methods for profiling metabolically active microbial populations and communities, including stable isotope profiling (SIP) and bromodeoxyuridine immunocapture combined with T-RFLP
- Microbial diagnostic arrays

The list of methods included here is by no means exhaustive and reflects contributions solicited during the running

of COST 631. Several methods are not included here including automated ribosomal intergenic spacer analysis (ARISA) and length-heterogeneity PCR (LH-PCR). Phylogenetic analysis per se is not discussed and there is a certain inevitable overlap with **chapter 4.1** which deals with visualising and quantifying rhizosphere microorganisms and **chapter 4.4** which deals primarily with measurements of gene expression. Several of the methods which are “missing” from **chapter 4.4** are instead discussed here. Other comprehensive sources of information exist on methods of microbial quantification and identification (Kowalchuk et al., 2004) and it is not our purpose to duplicate that information here, rather to provide useful information from a rhizosphere or mycorrhizosphere perspective.

Morphological and antibody based methods have now largely given way to DNA-based methods. Only 17% of the 70 000 fungal species hitherto described have been successfully cultivated (Hawksworth, 2001) and traditional methods based on morphology are limited by the fact that they often overlook asexual, cryptic and obligately biotrophic species. Biochemical methods for environmental monitoring of fungi have been developed and have been useful for identification of culturable plant pathogens and commercially important strains. Substrate utilization assays using 96-well microtitration plates (e.g. BIOLOG) were originally developed for identification of single bacterial strains and they are not suitable for studies of fungal communities although they can be used to identify individual culturable fungi. Phospholipids

are essential components of cell membranes and are rapidly degraded after cell death. Profiling of phospholipid fatty acids (PFLAs) or fatty acid methyl esters (FAMES) has been used to monitor overall shifts in subsets of the microbial community such as bacteria, actinomycetes and fungi (Zelles et al., 1999) but many fatty acids are common to large numbers of different fungal species and much less information has been accumulated on the fatty acid composition of fungi so the approach is unlikely to be useful for detailed studies of fungal community structure.

DNA-based methods for analysing bacterial and fungal communities have been in use since the early 1990s and been progressively refined. Following the development of PCR, restriction enzymes and the design of appropriate primers one main approach has been to use PCR amplification, followed by digestion with restriction enzymes and separation of the fragments by electrophoresis. The restriction fragment length polymorphism (RFLP) patterns obtained can be compared with known standards. The non-coding internal transcribed spacer (ITS) region of the rRNA genes are used since the intraspecific variation seems to be fairly low but interspecific variation is high. Resolution of the RFLP technique can be improved by using fluorescently tagged oligonucleotide primers and automated capillary electrophoresis detection of the end-labelled fragments, a technique referred to as T-RFLP (Terminal Restriction Fragment Length Polymorphism) (Liu et al., 1997; Osborn et al., 2000; Artursson et al., 2005). Electrophoresis can also be carried out using gradients of chemical denaturants (DGGE – Denaturing Gradient Gel Electrophoresis) (**43_Prosser_a**; **43_Santos**; Muyzer and Smalla, 1998; Kowalchuk, 2002) or heat as a denaturant (TGGE – Temperature Gradient Gel Electrophoresis) (**43_Corgie**; Cornejo et al., 2004). These two methods are capable of separating very similar sequences and offer a good compromise between the number of samples that need to be processed and the information that can be obtained. Another method, makes use of

differential electrophoretic mobilities due to single strand conformation polymorphisms (SSCP).

Stable isotope probing (SIP) with DNA or RNA (Radajewski et al., 2000 and 2003; Rangel-Castro, 2005a,b) offers new possibilities to link information about the metabolically active fraction of a community with profiling techniques such as DGGE and the advantages and disadvantages are discussed (**43_Prosser_b**). Immunocapture of nucleotide analogues such as bromodeoxyuridine is not yet covered but described by Artursson et al. (2005). New molecular fingerprinting techniques based on nucleic acid microarrays (**43_Bodrossy**) offer potential advances in multiplex detection using large sets of probes and are discussed in this **chapter 4.3.7** but a number of technical challenges remain in the analysis of complex environmental samples.

General references

- Artursson, V.; Finlay, R.D.; Jansson, J. 2005. Combined bromodeoxyuridine immunocapture and terminal-restriction fragment length polymorphism analysis highlights differences in the active soil bacterial metagenome due to *Glomus mosseae* inoculation or plant species. *Environmental Microbiology* 7: 1952-1966.
- Artursson, V.; Jansson, J.K. 2003. Use of bromodeoxyuridine immunocapture to identify active bacteria associated with arbuscular mycorrhizal hyphae. *Applied and Environmental Microbiology* 69:6208-6215.
- Bidartondo, M.I.; Gardes, M. 2005. Fungal Diversity in Molecular Terms: Profiling, Identification, and Quantification in the Environment. In: Dighton, J.; White, J.F.; Oudemans, P. (eds.) *The Fungal Community, Its Organisation and Role in the Ecosystem*. CRC Press, Boca Raton, pp. 215-239.
- Borneman, J. 1999. Culture-independent identification of microorganisms that respond to specified stimuli. *Applied and Environmental Microbiology* 65: 3398-3400.
- Cornejo, P.; Azcon, A.C.; Barea, J.M.; Ferrol, N. 2004. Temporal temperature gradient gel electrophoresis (TGGE) as a tool for the characterization of arbuscular mycorrhizal fungi. *FEMS Microbiology Letters* 241: 265-270.
- Gardes, M.; Bruns, T.D. 1993. ITS primers with enhanced specificity for basidiomycetes-application to the identification of mycorrhizae and rusts. *Molecular Ecology* 2: 113-118.

Hawksworth, D.L. 2001. The magnitude of fungal diversity : the 1.5 million species estimate revisited. *Mycological Research* 105: 1422–1432.

Jansson, J.K. 2003. Marker and reporter genes: illuminating tools for environmental microbiologists. *Current Opinion in Microbiology* 6: 310–316.

Kowalchuk, G.A.; de Bruijn, F.J.; Head, I.M.; Akkermans, A.D.L.; van Elsas, J.D. (eds). 2004. *Molecular Microbial Ecology Manual*. Second Edition. Springer.

Kowalchuk, G.A.; de Souza, F.A.; van Veen, J.A. 2002. Community analysis of arbuscular mycorrhizal fungi associated with *Ammophila arenaria* in Dutch coastal sand dunes. *Molecular Ecology* 11: 571-581.

Liu, W.T.; Marsh, T.L.; Cheng, H.; Forney, L.J. 1997. Characterization of microbial diversity by determining terminal restriction fragment length polymorphisms of genes encoding 16S rRNA. *Appl. Environ. Microbiol.* 63: 4516-4522.

Mullis, K.B.; Faloona, F.A. 1987. Specific synthesis of DNA *in vitro* via a polymerase-catalysed chain reaction. *Methods Enzymol.* 155: 335-350.

Muyzer, G.; Smalla, K. 1998. Application of denaturing gradient gel electrophoresis (DGGE) and temperate gradient gel electrophoresis (TGGE) in microbial ecology. *Antonie van Leeuwenhoek* 73: 127-141.

Osborn, A.M.; Moore, E.R.B.; Timmis, K.N. 2000. An evaluation of terminal-restriction fragment length polymorphism (T-RFLP) analysis for the study of microbial community structure and dynamics. *Environ. Microbiol.* 2: 39-50.

Radajewski, S.; Ineson, P.; Parekh, N.R.; Murrell, J.C. 2000. Stable-isotope probing as a tool in microbial ecology. *Nature* 403: 646-649.

Radajewski, S.; McDonald, I.R.; Murrell, J.C. 2003. Stable-isotope probing of nucleic acids: a window to the function of uncultured microorganisms. *Current Opinion in Biotechnology* 14: 296-302

Rangel-Castro, J.I.; Prosser, J.; Ostle, N.; Scrimgeour, C.M.; Killham, K.; Nicol, G.W.; Meharg, A. 2005. Flux and turnover of fixed carbon in soil microbial biomass of limed and unlimed plots of an upland grassland ecosystem. *Environmental Microbiology* 7: 544-552

Rangel-Castro, J.I.; Killham, K.; Ostle, N.; Nicol, G.W.; Scrimgeour, C.M.; Ineson, P.; Meharg, A.; Prosser, J. 2005. Stable isotope probing analysis of the influence of liming on root exudate utilization by soil microorganisms. *Environmental Microbiology* 7: 828-838.

Rosling, A.; Landeweert, R.; Lindahl, B.D.; Larsson, K.-H.; Kuyper, T.W.; Taylor, A.F.S.; Finlay, R.D. 2003. Vertical distribution of ectomycorrhizal fungal taxa in a podzol profile determined by morphotyping and genetic verification. *New Phytologist* 159: 775-783.

Toljander, J.F.; Artursson, V.; Paul, L.R.; Jansson, J.K.; Finlay, R.D. 2005. Colonisation of vital and non-vital *Glomus claroideum* Schenk & Smith

hyphae by gfp-tagged bacteria *in vitro*. *FEMS Microbiology Letters* 254: 34-40.

White, T.J.; Bruns, T.; Lee, S.; Taylor, J. 1990. Amplification and direct sequencing of fungal ribosomal RNA genes for phylogenetics. *PCR Protocols: A guide to Method and Applications*: 315-322.

Zelles, L. 1999. Fatty acid patterns of phospholipids and lipopolysaccharides in the characterisation of microbial communities in soil: a review. *Biology and Fertility of Soils* 29: 111-129.

4.3.2. Microscopy and Anatomy

Although many methods based on microscopy and descriptions of anatomy or morphology have now been replaced by molecular methods, these classical methods are still useful and can provide a good complement to DNA based methods. Many of these methods have a direct relevance to rhizosphere research since they involve visualisation of microorganisms on or close to root surfaces. Ectomycorrhizal roots have characteristic morphological features that enable preliminary identification prior to molecular identification which may save both time and cost. This section contains two method sheets (**43_Taylor**; **43_Grebenc**) describing such methods – for a fuller description the reader is referred to standard works by Agerer (1996-2004). The methods are based on detailed descriptions of the fungal mantle, and hyphae and rhizomorphs emanating from it as well as structures such as cystidia.

Potential problems and constraints of methods based on morphology include the fact that they often require extensive experience and take a long time to learn. Morphology of roots may also vary according to age or physiological condition/vitality of the roots. However successful morphotyping of roots prior to DNA based analyses may save time and reduce the costs of molecular analyses. Other methods described in this section also include microscopic analysis of microconidia germination of *Fusarium oxysporum* in root exudates (**43_Steinkellner**).

Other methods to describe rhizoplane microflora by means of image analysis are described in **chapter 4.1 (41_Dazzo, Dazzo 2004)** and may be combined with

immunofluorescence, FISH, BacLight Live/Dead probes to gain more knowledge about the numbers, identity or activity of specific taxa. Luminescent (eg *lux*, *luxAB*) and fluorescent (*gfp* & DsRed) marker and reporter genes offer convenient methods for *in situ* detection of microorganisms and their activities. These are not widely covered in the Handbook but their use is reviewed by Jansson (2003) and carbon biosensing with *lux*-marked *Pseudomonas fluorescens* is covered in section 3.2 (**32_Standing**). Fusion of the promoter of a particular gene of interest to a *gfp* gene enables the expression levels of the gene of interest to be measured by quantifying the level of GFP fluorescence using confocal laser scanning microscopy (**41_Rothballer**). Potential problems with these methods include strong autofluorescence in many soils but use of a wavelength-specific detector enables digital separation of the signal from background autofluorescence.

Basic references

Agerer, R. 1986-1998. Colour Atlas of Ectomycorrhizae. Einhorn-Verlag, Schwäbisch-Gmünd.

Agerer, R. 1991. Characterization of Ectomycorrhiza. Methods in Microbiology 23: 25-73.

Agerer, R. et al. 1996-2004. Descr. of Ectomycorrhizae. Einhorn-Verlag, Schwäbisch-Gmünd.

Dazzo, F. 2004. Applications of quantitative microscopy in studies of plant surface microbiology. In: Varma, A. et al. (eds.) Plant Surface Microbiology, Springer-Verlag, Berlin, pp. 503-550.

Jansson, J.K. 2003. Marker and reporter genes: illuminating tools for environmental microbiologists. Current Opinion in Microbiology 6: 310-316.

Standing, D.B.; Meharg, A.A.; Killham, K. 2003. A tripartite microbial reporter gene-system for real-time assays of soil nutrient status. FEMS Microbiology Letters 220: 35-39.

Related method sheets

ID	32_Standing
Parameter	Carbon exudation from plant roots
Soil type	Sandy loams to clays
Plant species	Developed on <i>Triticum aestivum</i> cv. Scout (wheat)
System	Liquid batch culture, soil slurries, soil microcosms using field soils
Method	Carbon biosensing with <i>lux</i>-marked <i>Pseudomonas fluorescens</i>

ID	41_Rothballer
Parameter	<i>In situ</i> detection of bacterial gene expression in the rhizosphere
Plant species	cereals, tomato
System	monoxenic quartz sand system
Method	translational promoter fusion

ID	43_Grebenc
Parameter	Identification and characterisation of types of ectomycorrhiza
Soil type	Forest Soils
Plant species	Spruce, beech, silver fir, pine, alder, oak
System	<i>In situ</i> - Forest ecosystems
Method	Anatomical and molecular identification and quantification of types of ectomycorrhiza

ID	43_Steinkellner
Parameter	Microconidia germination of <i>Fusarium oxysporum</i> in root exudates
Plant species	Any plant
System	Perlite culture in growth chamber
Method	Microscopic analysis

ID	43_Taylor
Parameter	Morphological identification of ectomycorrhiza
Soil type	Most soil types
Plant species	Predominantly Pine, Spruce and Birch but also other plant species
System	Harvested root tips
Method	Morphotyping of ectomycorrhizal roots

The use of chemical markers such as phospholipid fatty acids (PLFAs) and fatty acid methyl esters (FAMES) has mainly been employed to look at overall shifts in the microbial community (Zelles, 1999), rather than to identify particular species. Some of these methods are therefore described in **chapter 4.1** of the handbook (**41_Olsson**, **41_Puglisi**).

4.3.3. DNA/RNA extraction from soil/roots

Development of PCR technology (Mullis and Faloona, 1987) greatly increased the sensitivity and specificity of molecular tools and led to the growth of molecular ecology as a discipline in the 1990s. Ribosomal DNA molecules have been popular since they are typically present in multiple copies in organisms, they have highly conserved sequence domains suitable for the design of fungal specific

primers (White et al., 1991; Gardes and Bruns, 1993) and their sequence variation spans hierarchical levels of phylogenetic diversity.

One method for determination of DNA from rice paddy soil (**43_Shinano**) and one method for extraction of DNA from individual ectomycorrhizal root tips of forest trees (**43_Rosling_a**) are presented.

Basic references

Gardes, M.; Bruns, T.D. 1993. ITS primers with enhanced specificity for basidiomycetes--application to the identification of mycorrhizae and rusts. *Molecular Ecology* 2: 113-118.

Mullis, K.B.; Faloona, F.A. 1987. Specific synthesis of DNA *in vitro* via a polymerase-catalysed chain reaction. *Methods Enzymol.* 155: 335-350.

White, T.J.; Bruns, T.; Lee, S.; Taylor, J. 1990. Amplification and direct sequencing of fungal ribosomal RNA genes for phylogenetics. *PCR Protocols: A guide to Method and Applications*: 315-322.

Related method sheets

ID	43_Peter_a
Parameter	Ectomycorrhizal DNA and RNA
Plant species	Ectomycorrhizas of <i>Laccaria bicolor</i> / Douglas fir
System	Microcosms under sterile or greenhouse conditions, field
Method	Sampling of ectomycorrhizas, DNA / RNA preparations, and genotyping

ID	43_Peter_b
Parameter	Ectomycorrhizal RNA
Plant species	Ectomycorrhizas of <i>Laccaria bicolor</i> / Douglas fir, <i>L. bicolor</i> / Poplar, <i>Pisolithus microcarpus</i> / Poplar, <i>P. microcarpus</i> / <i>Eucalyptus globulus</i>
System	Microcosms under sterile or greenhouse conditions, and in the field
Method	RNA extraction from ectomycorrhizas

ID	43_Rosling_a
Parameter	Identification of ectomycorrhizal symbionts from individual root tips
Soil type	Organic and mineral soil
Plant species	Ectomycorrhizal root tips from forest trees
System	field or microcosm
Method	Part 1: DNA extraction

ID	43_Shinano
Parameter	DNA in soil
Soil type	Paddy soil
Plant species	Rice
System	Field soil
Method	Determination of soil DNA content

4.3.4. PCR / RFLP / cloning / sequencing

Extracted DNA is typically amplified using PCR prior to analysis of restriction fragment length polymorphism or direct sequencing. In prokaryotes the 16S rRNA gene sequence is used whereas in fungi the internal transcribed spacer (ITS) region is used since it has a low level of intraspecific variation and a high level of interspecific variation. Optimal DNA template concentrations need to be established individually for each sample using dilution series. Following amplification of the DNA by PCR the PCR product can be digested using restriction enzymes and the resulting fragments can be separated electrophoretically. The patterns obtained from different species are polymorphic due to mutations in the restriction sites. These restriction fragment length polymorphisms (RFLPs) can be used as an intermediate step prior to sequencing PCR clones. In this section of the handbook PCR-RFLP analysis of ectomycorrhizal fungal symbionts (**43_Rosling_b**) and sequence analysis of the ITS region of the rRNA gene (Rosling et al., 2003; **43_Rosling_c**) are described for fungi colonising single roots. Extraction of DNA from roots of woody plants can be problematical because of the high amounts of phenolic material and tannins and a suitable protocol is described by Brunner (**43_Brunner**). A box-PCR-gel electrophoresis method (**43_Ködöbös**) is presented for the study of diversity of *Rhizobium loti* populations in relation to different agricultural practices. Zakhia et al. (**43_Zakhia**) also present an SDS-PAGE, Amplified Ribosomal DNA Restriction analysis (ARDRA) method for characterisation of legume nodulating bacteria. PCR, cloning and sequencing can be used to validate a number of rapid screening techniques and a method is described by Jansa (**43_Jansa_a**) for

arbuscular mycorrhizal fungal spores and plant roots colonised by AM fungi.

Basic references

Rosling, A.; Landeweert, R.; Lindahl, B.D.; Larsson, K.-H.; Kuyper, T.W.; Taylor, A.F.S.; Finlay, R.D. 2003. Vertical distribution of ectomycorrhizal fungal taxa in a podzol profile determined by morphotyping and genetic verification. *New Phytologist* 159: 775-783.

Zakhia, F; Jeder, H.; Domergue, O.; Willems, A.; Cleyet-Marel, J.C.; Gillis, M.; Dreyfus, B.; de Lajudie, P. 2004. Characterisation of wild legume nodulating bacteria (LNB) in the infra-arid zone of Tunisia System. *Appl. Microbiol.* 27:380-395.

Related method sheets

ID	43_Brunner
Parameter	Identification of tree fine roots
Soil type	Forest soils
Plant species	All tree species from Central Europe, including pine, spruce, larch, fir, beech, oak, chestnut, alder, poplar, maple, ash, elm, and others.
System	Molecular identification with the trnL intron of plastid DNA
Method	PCR amplification and RFLP analysis of fine root DNA

ID	43_Jansa_a
Parameter	Cloning and sequencing AMF DNA
Plant species	any AMF host plant, better: non-woody roots
System	field samples, pot experiments
Method	DNA extraction, PCR amplification, cloning and sequencing from AMF spores and roots

ID	43_Ködöbös
Parameter	Diversity assessment of <i>Rhizobium loti</i> populations
Plant species	Leguminous plants (<i>Rhizobium</i> bacteria, isolated from the root nodules of the hosts)
Method	BOX-PCR gel-electrophoresis

ID	43_Rosling_b
Parameter	Identification of ectomycorrhizal symbionts from individual root tips
Soil type	Organic and mineral soil
Plant species	Ectomycorrhizal root tips from forest trees
System	field or microcosm
Method	Part 2: PCR-RFLP

ID	43_Rosling_c
Parameter	Identification of ectomycorrhizal symbionts from individual root tips
Soil type	Organic and mineral soil
Plant species	Ectomycorrhizal root tips from forest trees
System	field or microcosm
Method	Part 3: Sequencing of the rDNA ITS region

ID	43_Zakhia
Parameter	Phylogenetic characterisation of Legume Nodulating Bacteria (LNB)
Plant species	Wild Mediterranean legumes : 22 species in Tunisia and 27 in Lebanon
Method	SDS-PAGE; Amplified Ribosomal DNA Restriction Analysis and sequencing

4.3.5. Microbial fingerprinting techniques (T-RFLP / DGGE / TGGE / SSCP)

To analyse PCR amplicons from complex environments and address questions concerning the spatial and temporal variability of microbial populations it has been necessary to develop community profiling methods which permit rapid, simultaneous and culture-independent analysis of multiple environmental samples. The methods described in this section make use of different properties of the pool of amplified gene fragments following DNA extraction and PCR. These methods usually rely on agarose or polyacrylamide gel electrophoresis and differential migration of amplified fragments due to differences in size, sequence, melting temperatures or conformation.

Modification of the RFLP technique by using fluorescently-tagged PCR primers, reduces the complexity of the analysed profiles since only the end-labelled fragments are detected (Liu et al., 1997, Osborn et al., 2000). This technique is referred to as terminal restriction fragment length polymorphism (T-RFLP) and has become one of the most useful methods of rapid profiling of communities. The method can be performed on automated sequencers which record the terminal restriction fragment length and relative abundance (peak height). The "electropherogram" produced consists of a number of peaks of varying height and

separation which can be compared with known standards. The method is rapid and sensitive and can be used to compare communities but all bands are counted equivalently and phylogenetic disparity between them is unknown. The method has been used to investigate changes in bacterial communities associated with arbuscular-mycorrhizal inoculation or different plant species (Artursson et al., 2005, **43_Artursson**), ectomycorrhizal fungi colonising roots in different soil profiles (Dickie et al. 2002).

In denaturing gradient gel electrophoresis (DGGE) (Kowalchuk *et al.*, 2002; Muyzer and Smalla, 1998) or temperature gradient gel electrophoresis (TGGE) (Muyzer et al., 1993; Muyzer and Smalla 1998; Cornejo *et al.* 2004) DNA fragments are separated by a linear gradient of increasing denaturant (chemical or heat). Sensitivity of the technique is improved by adding a GC-clamp to prevent the DNA fragment from fully melting. The method has been applied to bacterial communities (**43_Prosser_a**) and arbuscular mycorrhizal communities (**43_Santos**). One disadvantage is that the method requires the construction of gradient gels, a process that requires some skill. The method sheet by Corgié et al. (**43_Corgie**) describes the method of TGGE applied to bacterial communities.

Single stranded conformational polymorphism (SSCP) analysis (**43_Jansa_b**) is based on the principle that single stranded DNA adopts a tertiary structure that is sequence specific. The technique does not require the construction of gradient gels.

Basic references

Artursson, V.; Finlay, R.D.; Jansson, J. 2005. Combined bromodexyridine immunocapture and terminal-restriction fragment length polymorphism analysis highlights differences in the active soil bacterial metagenome due to *Glomus mosseae* inoculation or plant species. Environmental Microbiology 7: 1952-1966.

Cornejo, P.; Azcon, A.C.; Barea, J.M.; Ferrol, N. 2004. Temporal temperature gradient gel electrophoresis (TGGE) as a tool for the characterization of arbuscular mycorrhizal fungi. FEMS Microbiology Letters 241: 265-270.

Dickie, I.A.; Xu, B.; Koide, R.T. 2002. Vertical niche differentiation of ectomycorrhizal hyphae in soil as shown by T-RFLP analysis. New Phytologist 156: 527-535.

Kowalchuk, G.A.; de Souza, F.A.; van Veen, J.A. 2002. Community analysis of arbuscular mycorrhizal fungi associated with *Ammophila arenaria* in Dutch coastal sand dunes. Molecular Ecology 11: 571-581.

Liu, W.T.; Marsh, T.L.; Cheng, H.; Forney, L.J. 1997. Characterization of microbial diversity by determining terminal restriction fragment length polymorphisms of genes encoding 16S rRNA. Appl. Environ. Microbiol. 63: 4516-4522.

Muyzer, G.; de Waal, E.C.; Uitterlinden, A.G. 1993. Profiling of complex microbial-populations by denaturing gradient gel-electrophoresis analysis of polymerase chain reaction-amplified genes-coding for 16S ribosomal-RNA. Appl. Environ. Microbiol. 59: 695-700.

Muyzer, G.; Smalla, K. 1998. Application of denaturing gradient gel electrophoresis (DGGE) and temperate gradient gel electrophoresis (TGGE) in microbial ecology. Antoine van Leuwenhoek 73: 127-141.

Osborn, A.M.; Moore, E.R.B.; Timmis, K.N. 2000. An evaluation of terminal-restriction fragment length polymorphism (T-RFLP) analysis for the study of microbial community structure and dynamics. Environ. Microbiol. 2: 39-50.

Related method sheets

ID	43_Artursson
Parameter	Identification of bacterial communities in soil
Soil type	All kinds
Plant species	All kinds
System	Field soil , greenhouse studies, microcosms
Method	T-RFLP identification of bacterial communities

ID	43_Corgie
Parameter	Bacterial community structure
Soil type	PAH-spiked sand
Plant species	Lolium perenne
System	Compartment device. See 11_Corgie
Method	PCR-TGGE

ID	43_Jansa_b
Parameter	SSCP fingerprinting
Plant species	maize, wheat
System	field samples, pot experiments
Method	Assessment of sequence composition/diversity of AMF DNA by single strand conformation polymorphism (SSCP) analysis

ID	43_Prosser_a
Parameter	Microbial community analysis
Soil type	Any
Plant species	Any
Method	Microbial community analysis by denaturing gradient gel electrophoresis (DGGE)

ID	43_Santos
Parameter	Arbuscular mycorrhizal fungi colonising plant roots
Soil type	Sandy loam
Plant species	<i>Achillea millefolium</i> , <i>Festuca pratensis</i>
System	Field grassland system
Method	Arbuscular mycorrhizal fungal community analysis by denaturing gradient gel electrophoresis (DGGE)

4.3.6. Identification of metabolically active populations

Stable isotope probing (SIP) (Radajewski *et al.* 2000, 2003) offers exciting new possibilities to identify the metabolically active fraction of microbial communities and to link molecular fingerprinting techniques to information about which organisms are responding to an environmental change or taking part in particular metabolic interactions. Incorporation of stable isotopes into DNA or RNA takes place before the heavy and light fractions are separated by density gradient centrifugation. The methods are of particular interest in studying complex plant-soil-microbe interactions in the rhizosphere environment (Singh *et al.* 2004). One key question relevant to the rhizosphere is the link between microbial diversity and rhizosphere carbon flow (Rangel-Castro *et al.* 2005a,b). Labelled carbon can be applied either as ^{13}C to plant shoots to study utilisation of root exudates or in the form of specific ^{13}C -labelled organic substrates applied to the soil.

An advantage of the method is that it allows in situ functional analysis of microbial communities without the need for cultivation. One potential problem is obtaining sufficiently high enough levels of ^{13}C labelling for detection and a lower limit of 10^6 cells per gram of soil has been identified. Another problem is that of distinguishing between incorporation of substrates by primary utilisers and

secondary incorporation of excretion or degradation products.

Immunocapture of nucleotide analogues is an alternative method of distinguishing the active fraction of a microbial community (Borneman, 1999) and use of bromodeoxyuridine immunocapture combined with T-RFLP has been used by Artursson *et al.* (2005) in studies of bacteria associated with arbuscular-mycorrhiza.

Basic references

- Artursson, V.; Finlay, R.D.; Jansson, J. 2005. Combined bromodeoxyuridine immunocapture and terminal-restriction fragment length polymorphism analysis highlights differences in the active soil bacterial metagenome due to *Glomus mosseae* inoculation or plant species. *Environmental Microbiology* 7: 1952-1966.
- Borneman, J. 1999. Culture-independent identification of microorganisms that respond to specified stimuli. *Applied and Environmental Microbiology* 65: 3398-3400.
- Lueders, T.; Wagner, B.; Claus, P.; Friedrich, M.W. 2004a. Stable isotope probing of rRNA and DNA reveals a dynamic methylotroph community and trophic interactions with fungi and protozoa in oxic rice fields soil. *Environmental Microbiology* 6: 60-72.
- Lueders, T.; Manefield, M.; Friedrich, M.W. 2004b. Enhanced sensitivity of DNA- and rRNA-based stable isotope probing by fractionation and quantitative analysis of isopycnic centrifugation gradients. *Environmental Microbiology* 6: 73-78.
- Radajewski, S.; Ineson, P.; Parekh, N.R.; Murrell, J.C. 2000. Stable-isotope probing as a tool in microbial ecology. *Nature* 403: 646-649.
- Radajewski, S.; McDonald, I.R.; Murrell, J.C. 2003. Stable-isotope probing of nucleic acids: a window to the function of uncultured microorganisms. *Current Opinion in Biotechnology* 14: 296-302.
- Rangel-Castro, J.I.; Prosser, J.; Ostle, N.; Scrimgeour, C.M.; Killham, K.; Nicol, G.W.; Meharg, A. 2005. Flux and turnover of fixed carbon in soil microbial biomass of limed and unlimed plots of an upland grassland ecosystem. *Environmental Microbiology* 7: 544-552.
- Rangel-Castro, J.I.; Killham, K.; Ostle, N.; Nicol, G.W.; Scrimgeour, C.M.; Ineson, P.; Meharg, A.; Prosser, J. 2005. Stable isotope probing analysis of the influence of liming on root exudate utilization by soil microorganisms. *Environmental Microbiology* 7: 828-838.
- Singh, B.K.; Millard, P.; Whiteley, A.S.; Murrell, J.C. 2004. Unravelling rhizosphere-microbial interactions: opportunities and limitations. *Trends Microbiol.* 12: 386-393.

Related method sheet

ID	43_Prosser_b
Parameter	¹³C-labelled DNA
Soil type	Any
System	Liquid batch culture, soil slurries, soil microcosms and field soils
Method	Stable isotope probing of microbial communities

4.3.7. Microbial diagnostic arrays

Different types of arrays are available for use in microbial community studies. Conventional membrane-based (dot-blot) taxon-specific oligonucleotide probes (TSOPs) have been used to analyse fungal community composition (Bruns & Gardes, 1993; Valinsky et al., 2002). DNA microarrays originally designed for large scale sequencing and genetic analyses are now used routinely in functional genomics and have exceptionally high throughput capacity (Gibson, 2002; Zhou and Thompson, 2002; Wu et al., 2001) making them theoretically advantageous for large scale analyses of complex microbial communities. However these approaches have still to be validated with diverse environmental samples where target and probe sequences are very diverse and often contaminated with contaminants which may interfere with DNA hybridisation. Sensitivity is an issue since the retrievable biomass in environmental samples is low and the extent to which detection can be reliably quantitative under different conditions is still uncertain. Microarrays can be used in environmental studies in three different ways, depending upon the type of probe arrayed. Phylogenetic oligonucleotide arrays (POAs) contain sequence probes derived from rRNA and are used primarily for phylogenetic analysis of microbial community composition. Functional gene arrays (FGAs) contain genes encoding key enzymes involved in biochemical cycling processes and can be used to monitor physiological status and functioning of microbial communities in different environments. Community genome arrays (CGAs) are constructed using whole genomic DNA isolated from pure cultures and can be used to describe a microbial community in terms of its cultivable component. Despite the uncertainties surrounding specificity,

sensitivity and quantitation (Zhou and Thompson, 2002) microarrays are considered to have great potential for future analyses of complex microbial communities. However the amounts of data which will be generated are enormous and bioinformatic tools developed for analysing gene expression data may be inadequate for dealing with complex environmental samples. Other recent studies describing use of arrays are provided by Bodrossy and Sessitsch (2004), Loy et al. (2002) and Stralis-Pavese (2004).

Basic references

- Bodrossy, L.; Sessitsch, A. 2004. Oligonucleotide microarrays in microbial diagnostics. *Current Opinion Microbiology* 7: 245-254.
- Bruns, T.D.; Gardes, M. 1993. Molecular tools for the identification of ectomycorrhizal fungi: taxon-specific oligonucleotide probes for suilloid fungi. *Molecular Ecology* 2: 233-242.
- Gibson, G. 2002. Microarrays in ecology & evolution: a preview. *Molecular Ecology* 11: 17-24.
- Loy, A.; Lehner, A.; Lee, N.; Adamczyk, J.; Meier, H.; Ernst, J.; Schleifer, K.-H.; Wagner, M. 2002. Oligonucleotide microarray for 16S rRNA gene-based detection of all recognized lineages of sulphate-reducing prokaryotes in the environment. *Appl. Environ. Microbiology* 68: 5064-5081.
- Stralis-Pavese, N.; Sessitsch, A.; Weilharter, A.; Reichenauer, T.; Riesing, J.; Csontos, J.; Murrell, J.C.; Bodrossy, L. 2004. Optimisation of diagnostic microarray for application in analysing landfill methanotroph communities under different plant covers. *Environmental Microbiology* 6: 347-363.
- Valinsky, L.; Della Vedova, G.; Jiang, T.; Borneman, J. 2002. Oligonucleotide fingerprinting of rRNA genes for analysis of fungal community composition. *Appl. Environ. Microbiology* 68: 5999-6004.
- Wu, L.; Thompson, D.K.; Li, G.; Hurt, R.A.; Tiedje, J.M.; Zhou, J. 2001. Development and evaluation of functional gene arrays for detection of selected genes in the environment. *Applied and Environmental Microbiology* 67: 5780-5790.
- Zhou, J.M.; Thompson, D.K. 2002. Challenges in applying microarrays to environmental studies. *Current Opinion in Biotechnology* 13: 204-207.

Related method sheet

ID	43_Bodrossy
Parameter	Microbial presence and abundance
Soil type	Any
Plant species	Any
System	Any
Method	Microbial diagnostic microarrays: target preparation and hybridis.

Editor: Martin-Laurent, Fabrice

UMR Soil Microbiology and Geochemistry, INRA-Burgundy University, 17 Rue Sully, BP 86510, 21065 Dijon Cedex, France

fmartin@dijon.inra.fr

4.4.1. Introduction

Soil micro-organisms are among the most diverse component of terrestrial ecosystems being notably involved in the transformation of the organic matter and thereby contributing to carbon and nutrient fluxes. Soil micro-organisms have long been considered as ubiquitous, meaning “everything is everywhere” leading to the common assumption that soil microbial communities are black boxes often considered as passive being controlled by abiotic factors such as temperature, humidity and pH. However, increasing evidence shows that major soil processes cannot be described only with abiotic factors underlining the role of the soil microflora. One of the key identified to understanding soil functioning is the description of the composition and the biodiversity of soil microbial communities. This has prompted increase research into microbial composition and metabolic functions. However, considerable lack of knowledge remains concerning the description of the hypothetical interrelation between soil microbial diversity/composition and soil functioning.

Up to now, most of the microbial diversity studies conducted in complex ecosystems, such as soil, have been conducted using Pasteurian approaches which are known to be biased due to the unculturability of many micro-organisms. In the past decade, the development of new molecular biology methods primarily based on amplification of nucleic acids directly extracted from soil have provided a pertinent alternative to classical culture-based methods, providing new insights into the composition, richness and diversity of microbial communities.

The direct extraction of nucleic of acids from soil allowed their analysis by means of PCR based technologies. Most of these strategies targeted the ribosomal RNA which is the premier molecule for evaluating evolutionary relationships among microbes and which study by the application of molecular techniques to microbial systematics has revolutionized our view of the phylogenetic relationships among bacteria. Several methods such as terminal restriction fragment length polymorphism (T-RFLP), automated ribosomal intergenic spacer analysis (A-RISA), denaturing gel gradient electrophoresis (DGGE), and temperature gel gradient electrophoresis (TGGE) allowing the description of the genetic structure of bacterial communities or such as 16S rDNA amplified from soil DNA or RNA, cloning and sequencing OTUs or even metagenomic approaches allowing the description of genetic composition of bacterial communities are not covered in this chapter focused on gene expression of single species and communities.

This chapter covers new methodologies aiming to study gene expression of single species and communities in the environment.

4.4.2. mRNA isolation and quantification

Direct RNA extraction from environmental samples and cDNA analysis offers new perspectives in the understanding of structural and functional diversity of microbial communities. 16S rRNA is often used as one indicator of total bacterial activity but the analysis of mRNA of microbial key genes provides a

better comprehension of the regulation gene expression in complex environmental samples. Up to now, the study of gene expression relied on Northern blot analysis, RNase protection assay or semi-quantitative RT-PCR. However, the recent development of real time PCR gives the opportunity to not only quantify the genetic potential of microbial communities by determining the sequence copy number of a microbial gene using soil DNA as template but also offers also the possibility to quantify expression of the genetic potential of microbial communities from soil RNA extracts. Here, **44_Martin_Laurent** reports the quantification of microbial genes by real time reverse transcription PCR.

However, the application of these approaches requires the knowledge of the sequences of interest either to generate a probe or primer pairs specific for the targeted genes. This prerequisite limits their use to known genes and therefore restricts the study of functional changes in microbial communities in response to environmental stimuli. To overcome these limitations metagenomic approaches based on the study of microbial communities transcriptome address the collective genetic structure and functional composition of microbial communities without the bias or necessity for culturing the micro-organisms. Methods based on mRNA extraction, cDNA synthesis, subtraction/differential display and cloning initially developed for eukaryotic mRNA have been adapted to mRNA extracted from complex environmental samples. The major advantage of these approaches is to differentially identify new functional genes in response to environmental stimuli allowing the description of new microbial functions from environmental samples. Here, **44_Peter** reports the large scale analysis of gene expression in ectomycorrhizas. The description of the cDNA array analyses includes the sample preparation, the cDNA array construction and the data analysis. In addition, **44_VanTuinen** reports the study of gene expression to identify functional markers of mycorrhizal symbiosis. Transcriptomic approaches based on differential screening of cDNA synthesised from mRNA

such as mRNA differential display RT-PCR (DDRT-PCR) and variant such as RNA arbitrarily primed PCR (RAP-PCR) as well as suppressive subtractive hybridization (SSH) are not presented here.

Related method sheets

ID	44_Karlsson
Parameter	Amounts of nucleic acids in environmental samples
Soil type	Any
Plant species	Any
System	Field soils/roots, greenhouse studies, various microcosm
Method	Realtime quantitative PCR

ID	44_Martin_Laurent
Parameter	Quantification of microbial gene expression by RT-quantitative PCR
System	Microbial culture
Method	RT-quantitative PCR

ID	44_Peter
Parameter	Large scale analysis of gene expression in ectomycorrhizas
Plant species	Ectomycorrhizas of <i>Laccaria bicolor</i> / Dougl. fir, <i>L. bicolor</i> / Poplar, <i>Pisolithus microcarpus</i> / Poplar, <i>P. microcarpus</i> / <i>Eucalyptus globulus</i>
System	Ectomycorrhizal systems in microcosms under sterile or greenhouse conditions, and in the field
Method	cDNA array analys. of gene expr.

ID	44_vanTuinen
Parameter	Expression of genes, markers of a functional mycorrhizal symbiosis
Plant species	Mycorrhizal plant
Method	Reverse Northern hybridisation of cDNA arrays

4.4.3. Stable isotope probing

In the last few years, the development of stable isotope probing (SIP) of nucleic acids allows determining functionally active elements of microbial communities among complex natural communities. Initially, the application of stable isotope tracers was applied to determine physiologically active components of microbial communities by analysing lipid biomarkers labelled with ¹³C thereby giving new insights in microbial ecology. Coupled with isotope ratio monitoring- gas chromatography- mass spectrometry (IRM-GC-MS) allowing the analysis of the natural isotopic abundance of lipid

biomarkers refined this method offering the environmental role of uncultured micro-organisms to be inferred. However, this approach is not universal as the analysis of nucleic acids. From this point of view, DNA SIP seems to be a promising methodology associating the sharpness of stable isotope probing with the universality of nucleic acids (DNA / RNA) based methodologies. DNA-SIP was first applied to study micro-organisms potentially involved in C-1 metabolism in soil. The principle of this methodology relies on the incubation of soil microcosms with ^{13}C labelled organic molecules, the extraction of genomic DNA, the purification of ^{13}C -enriched DNA by CsCl-ethidium bromide density gradients. Then this fraction can be analysis using PCR based technologies such as those one relying on the analysis of rDNA genes of the ribosomal operon. In addition, the cloning of large fragments of ^{13}C -labelled DNA using bacterial artificial chromosome (BAC) vectors gives new insights for a more understandable genome-level analysis of uncultivable micro-organisms associated with a metabolic function. It offers unique insight in the understanding cycling of elements in microbial communities and thereby represents a singular opportunity in metagenomics. However, although DNA SIP offers challenging opportunities to study functional communities in complex environments, this methodology suffers from some technical limitations causing biases. Indeed, it is necessary to use a large excess of labelled substrate and to use relatively long incubation period to maximize ^{13}C uptake and to facilitate analysis of nucleic acids which is less sensitive than analogous lipid biomarkers. Due to these constraints two major biases can be identified: (i) extended time of incubation will lead to the accumulation of ^{13}C -metabolites that can be assimilated by second degraders rendering harder the analysis of the active bacterial community, (ii) when the complete degradation of ^{13}C -compound involved a bacterial consortium then DNA-SIP may not offer the possibility to determine the contribution of each member of the consortium. However, despite these limitations SIP offers a powerful tool for linking the detection of particular micro-organisms with specific

functions they realize in natural environments.

Here, **44_Berge** reports the application of DNA-SIP to study the genetic structure of root-exsudate microbial community structure encountered in the rhizosphere. The originality of the approach proposed here relies on the use of $^{13}\text{CO}_2$ to label plants which will in consequence produce ^{13}C labelled photosynthetates naturally released in the rhizosphere and made available to rhizospheric micro-organisms. The purification of DNA containing bromodeoxyuridine (BrdU) by immuno-capture used to infer the metabolic activity and function of microbial communities is not presented in this chapter.

Related method sheet

ID	44_Berge
Parameter	Root exudate-consuming microbial community structure
Soil type	Any
Plant species	Any
System	Laboratory microcosm
Method	DNA Stable Isotope probing

4.4.4. FISH-MAR

Together with the last developments of molecular ecology tools, the adaptation and the development of microscopic analysis such as FISH (fluorescence *in situ* hybridisation) allowed the localization of specific microbes by using specific nucleic probes labelled with fluorophore. FISH is often applied in microbial ecology to precisely localize microorganisms that contain rRNA hybridizing with a fluorescently labelled probe. In addition, the combination of FISH with microautoradiography (MAR) permits both the detection of microbial populations and the measurement of substrate utilisation within a microbial community. Here, **44_Schloter** reports in situ measurements of microbial functions by means of combination of MAR and FISH.

We can speculate that further inter-relational development of metagenomics with microscopy that can estimate gene number, gene expression, microbial activity and environmental conditions on a microscale will provide new insights into

the working net of microbial communities. As an example, the recent adaptation of FISH called RING-FISH (*recognition of individual genes-FISH*) that allows the visualization of plasmid or chromosomal gene *in situ* by increasing the sensitivity of detection bypasses the principal limitation of FISH which only permits the detection of abundant RNA and not single copy genes.

Related method sheet

ID	44_Schloter
Parameter	In situ meas. of microbial functions
System	Microcosm system
Method	Combination of microautoradiography and FISH

4.4.5. Proteomic approaches

The increasing number of whole-genome and environmental sequencing projects make feasible the application of functional environmental 'omic' approaches. It is most likely that in the next decade, large set of data reporting gene expression patterns within mixed communities of microorganisms will result from the analysis of DNA micro-arrays. This expectation leads to suggest that both transcriptomic and proteomic investigations will provide insights into microbial activities in the environment. Up to now proteomic techniques have mainly been applied used to study microbial culture or plant model to describe where and when proteins are expressed in order to better understand biological processes. The crucial step of this approach consisted in the sample preparation since the proteome is made of many proteins entering in the composition of different tissues, membranes or organelles. Protein extracts are then separated on 2-D gel electrophoresis and after differential screening peptides of interests are mapped and purified from the gel. Peptides are then analysed by mass spectrometry (MS), allowing the description of peptide mass fingerprint of the protein or internal amino-acid sequences. Peptide mass fingerprinting (PMF) relies on the comparison of experimentally obtained masses of peptides and *in silico* calculated masses of

proteins available in the protein databases. This computer based treatment is particularly well suited to study well characterized organisms or microorganisms for which the entire genome has been sequenced. To study not yet described organisms by proteomic approaches one must sequence peptide by mass spectrometry, through the generation of peptides ladders, in which individual peptides differ in length by one amino-acid. The recent introduction of ESI-Q-TOF and MALDI-Q-TOF has revolutionized this technology leading to not only the generation of peptide mass fingerprints but also to the description of sequence information. In fine, two types of MS data are produced: (i) peptide masses and (ii) fragmentation spectra. These two parameters are then compared to theoretical mass data produced *in silico* from sequence databases. This computer-based analysis allows the rapid identification of the protein when the sequence is available in the database otherwise it requires the careful interpretation of the fragmentation which is more time and man-power consuming.

Here, **44_Vanderleyden** reports quantitative differential proteome analysis by describing a two dimensional difference-in-gel electrophoresis (2D-DIGE) protocol. The last adaptation of proteomics tools developed on eukaryotic and prokaryotic models allowed their adaptation to complex environmental samples leading to the recent proposition of the term 'metaproteomics' for the large scale characterization on the entire protein complement of environmental microbial communities. These methodologies are not presented in this chapter.

Related method sheets

ID	44_Vanderleyden
Parameter	Quant. differential proteome anal.
System	Laboratory test with cultivated bacteria
Method	2D difference-in-gel electrophoresis

ID	41_Rothballer
Parameter	In situ detection of bact. gene expr.
Plant species	cereals, tomato
System	monoxenic quartz sand system
Method	translational promoter fusion

Editor: Heino Nietfeld

Institute of Soil Science & Forest Nutrition, University of Göttingen,
Büsgenweg 2, D-37077 Göttingen

hnietfe@gwdg.de

5.1.1. Introduction

Plants are highly dynamic biological systems that exchange relevant resources (carbon, water and mineral nutrients) with their environment. According to this system-oriented point of view any singular substantial exchange of matter affects resource fluxes at all parts of the system due to system-internal attributes. Any environmental impact results in a chain of feedback reactions of the whole plant including a coordinated interaction between above- and below-ground plant components (Stitt and Schulze, 1994), i.e. it affects all other plant-related resource fluxes (principle of 'total environment'; Chapin and Reus, 2001). The rhizosphere is involved in these plant-environment interrelations.

The conditions in the rhizosphere reflect the type and rate of rhizosphere processes which are affected by both, the resource acquisitions and/or losses via the active root and the feedback reactions of the rhizosphere soil upon the impact of the root (e.g. Cheng, 1999; Noble and Randall, 1998). They are dynamically constrained and controlled by whole plant responses to environmental changes and, conversely, the rhizosphere processes feed back on the whole plant development. The information on processes in the rhizosphere as the 'explanatory scale' serves for understanding and predictions of processes at the whole plant level. But each rhizosphere is unique in its characteristics because rhizosphere processes around individual roots may proceed differently thereby producing an extremely heterogeneous pattern of

rhizosphere conditions at the whole-plant level.

Consequently, rhizosphere research is implicitly confronted with the challenge to connect information at various scales. First, the consideration of the rhizosphere 'hot spots' as a whole and therefore the 'weighted evaluation' of this lower scale information provides an explanation of the observable phenomena on the whole-plant as the larger scale (Jarvis, 1995). Modelling can highlight simultaneously occurring rhizosphere processes. Models provide a useful tool for linking processes and measurement data at various scales. The rhizosphere models are soil micro-site models which focus on the quantitative description of processes proposed to be predominantly active in the rhizosphere thereby excluding or keeping constant the impact of other superimposing processes at the whole-plant level. Therefore, whole-plant models are not rhizosphere models in the narrow sense, but they are essential for the understanding and integration of the heterogeneous patterns of rhizosphere conditions at the whole-plant level.

There are two classes of approaches that calculate water and nutrient uptake at the whole-plant level:

- Bottom-up approaches use the micro-scale information at the single-root level and do not change the rhizosphere geometry for up-scaling to the whole plant
- Top-down approaches use information of process interactions at the soil-root interface in mass balance models at the whole-plant scale

Bottom-up approaches predict rhizosphere effects at the whole-plant level

by considering pre-defined patterns of spatial-temporal heterogeneity of rhizosphere model parameters. In top-down approaches some of the spatial patterns of rhizosphere model parameter values (e.g. bulk concentrations) are implicitly given by the structure of the mass balance models, e.g. the bulk concentration which is continuously changed due to the matter dynamics in the whole rooting space.

Relevant information on modelling rhizosphere processes is included in the classic textbooks of Tinker and Nye (2000) and Barber (1995), and is also presented in the reviews of Rengel (1993), Darrah (1993) and Passioura (1988). Approaches of integration of rhizosphere processes in whole-plant models are presented in Hopmans and Bristow (2002).

This chapter briefly describes the modelling approaches of some of the major rhizosphere processes and includes

- a short description of classic and some of recently developed rhizosphere models,
- examples of bottom-up and top-down approaches of nutrient and water uptake of plants and
- comments to sensitivity analysis and validation (corroboration) of rhizosphere models

Basic References

- Barber, S.A. 1995. Soil Nutrient Bioavailability. A Mechanistic Approach. Wiley, N.Y.
- Chapin, F.S.; Reus, R.W. 2001. The roots of the matter. *Nature* 411: 749-752.
- Cheng 1999. Rhizospheric feed-backs in elevated CO₂. *Tree Physiol.* 19: 313-320.
- Darrah, P.R. 1993. The rhizosphere and plant nutrition: a quantitative approach. *Plant Soil* 155/156: 1-20.
- Hopmans, J.W.; Bristow, K.L. 2002. Current capabilities and future needs of root water and nutrient uptake modeling. *Adv. Agron.* 77: 104-183.
- Jarvis, P.G. 1995. Scaling processes and problems. *Plant Cell and Environm.* 18: 1079-1089.
- Noble, A.D.; Randall, P.J. 1998. How trees affect soils. RIRDC Publication 98/16, 129pp.

Passioura, J.B. 1988. Water transport in and to the root. *Annu. Rev. Plant Physiol. Plant Mol. Biol.* 39: 245-265.

Rengel, Z. 1993. Mechanistic simulation models of nutrient uptake: A review. *Plant Soil* 152: 161-173.

Stitt, M.; Schulze, E.D. 1994. Plant growth, storage and resource allocation: from flux control in a metabolic chain to the whole plant level. In: Schulze, E.-D. (ed.) *Flux control in biological systems*. Acad. Press, San Diego, pp. 57-118.

Tinker, P.B.; Nye, P. 2000. *Solute movement in the rhizosphere*. Oxford Uni. Press.

5.1.2. Rhizosphere-Models: Quantifying feedbacks in the rhizosphere

The rhizosphere is defined as the small volume of soil surrounding the root which is affected by the root activity. This definition is implemented in the conceptual design of most rhizosphere models. The starting point in rhizosphere models is the single root. The root and the soil volume around the root are considered as cylinders. Therefore, it is assumed that the rhizosphere has the geometry of a hollow cylinder with the root surface as *inner boundary* and as *outer boundary* the rhizosphere periphery. All existing rhizosphere-models describe the dynamics of the matter considered (which is not necessarily a plant resource, e.g. Al, As) as affected simultaneously by the plant-driven resource fluxes at the root surface (absorption or deposition) and soil-related feedback reactions upon the impact of the root. These feedbacks may be classified into

- transport processes
- soil-chemical reactions
- microbially-driven reactions

Nearly all models assume that the reactive movement of the matter considered occurs perpendicular to the root and they describe the dynamics of the matter in radial-symmetrical distance to the root surface. Fig. 1 schematically shows the interrelation between processes occurring in the rhizosphere soil.

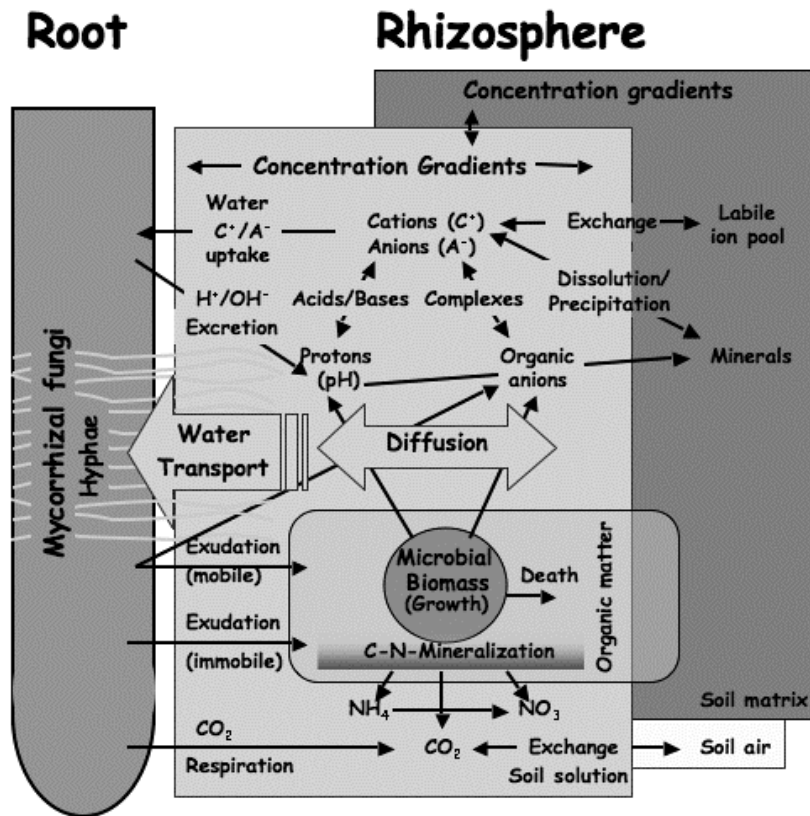

Fig.1: Schematic representation of major processes in the rhizosphere (see also colour plate on page 518).

The soil-chemical reactions mostly are described as equilibrium-reactions ('fast' reactions; Stumm and Morgan, 1995; Sposito, 1989) which follow the mass action law. Biological reactions are considered as irreversible reactions that usually are described by kinetic approaches ('slow' reactions). It is essential to note that the separation of chemical reactions into 'fast' and 'slow' reactions depends on the changes due to the transport velocity (Rubin, 1983).

The rhizosphere models may be classified into the classical one-component and in multi-species models. In multi-species models the reactive transport of a simultaneously moving set of chemical species is described. The simultaneous transport of each of the species is described under consideration of physical, chemical and biological interactions between them and the ion-specific influxes/effluxes at the root surface. These models lead to a system of coupled, often

highly non-linear partial differential equations.

5.1.2.1. Inner rhizosphere boundary: Influxes/effluxes at the root surface

Water and Ion uptake rates

The inflow of water into a single root is derived from the transpiration demand of the plant. As the water uptake rate of plants depends mainly on the day time water vapour deficit it is therefore a function of the day time and may be formulated following e.g. a sine function. The nutrient uptake rate by the root is usually described according to the Michaelis-Menten kinetics (e.g. **51_Steingrobe**); other uptake kinetics are the zero-sink and linear uptake kinetics (de Willigen and van Nordwijk, 1994). The maximum uptake rate may be considered as the potential uptake rate that is largely determined by the plant-internal status while the hyperbolic term including the Michaelis-Menten constant reflects its

concentration-dependent modification. The Michaelis Menten uptake parameters of nearly all nutrients have been determined for numerous various plant species and soils (Barber, 1995). In multi-species models these different uptake rates are used simultaneously (selectivity of the root mineral uptake) (**51_VanBeinum, 51_Nietfeld**). Values of the uptake parameters can be determined for various root types and root absorption zones (e.g. Häussling et al., 1988). The uptake of neutral and ionic chemicals is discussed by Trapp (2003).

Root excretions

The root is the major source of protons or hydroxyl-ions due to a cation-anion uptake imbalance. But in the existing one-component models the H^+/OH^- efflux has to be parameterized a priori (e.g. in Nye, 1981) in form of a given constant flux rate. In multi-species models these excretions have been formulated implicitly as the result of the cation-anion uptake-imbalance. As the actual uptake rates of the nutrients involved may change the excretion of H^+/OH^- ions may change as well (**51_Nietfeld**). For the excretions of organic matter mostly empirically derived flux rates are determined; the excretion of soluble and insoluble organic matter is usually assumed to follow a constant rate (Darrah, 1991). Also the excretion rate of organic anions is formulated by a constant flux rate (Kirk, 1999) or may be formulated by an empirical function (Jones, 1998). But roots do not excrete organic substances equally via the total active root system; the excretion may be restricted to specialized roots or/and its rate may be initialized by the low availability of certain nutrients (e.g. phosphorus) or the occurrence of toxic elements (e.g. aluminum). The excretion rates of CO_2 (root respiration rate) and O_2 (in rice plants) have been assumed to be controlled by the permeability of the root wall (Tinker and Nye, 2000; Kirk and Kronzucker, 2005; **51_van Bodegom**).

Root apoplast

The assumption of almost all existing rhizosphere models is that the root is

merely treated as an absorbing surface thereby ignoring the water and ion dynamics within the root apoplast. But there is evidence that ions can penetrate into the root cortex before becoming depleted which is most evident for nutrients that are not taken up mainly by the epidermal cells (Darrah, 1993). The inclusion of the root apoplast in the rhizosphere models allows for the entire cortex to participate in uptake as ions are transported into the cortical apoplast. A mechanistic description of water flow and nutrient transport through roots considers the parallel transport through the symplastic and apoplastic pathways (Steudle, 2000; see also Aura, 1996). The coupling of symplastic uptake and transport (e.g. diffusion) will result in the formation of a concentration gradient within the apoplast. In particular, the consideration of the ion dynamics in the root apoplast is important if non-nutrient ions (e.g. Al^{3+} ions) occupy the sorption sites of the cell-wall material in the root cortex thus affecting the actual uptake-rate of some nutrients by displacement (Meychik and Yermakov, 2001; Grignon and Sentinanc, 1991). Similar the diffusion transport and consumption of O_2 is described in roots (Kirk, 2003).

Root hairs and mycorrhiza

The assumption of a smooth root-cylinder as the absorbing surface is often not valid due to the morphological characteristics of the root. Root hairs have shown to be important in uptake of some nutrients (Tinker and Nye, 2000). In the mass balance equations they are considered as sink term that is spatially limited according to the length of the root hairs. Formally similar is the model of Schnepf and Roose (2006) in which the uptake of phosphate is calculated under consideration of mycorrhizal fungi. In their model, the classic rhizosphere model is extended by a temporarily expanding sink term around the root that represents the growing hyphal length density.

5.1.2.2. Transport processes in the rhizosphere

Water transport

The description of the water flux in the rhizosphere is based on Darcy's law that describes water flux as driven by the water potential gradient. The related models try to take into account drying soil around the root and examine the soil-root resistance in detail. Model calculations may result in gradients of the volumetric soil content if root water uptake is high and the soil-characteristic unsaturated water conductivity is low (see also discussion in Tinker and Nye, 2000; chapter 2). But the assumption of a uniform flow to the root or uniform water potential at the root surface was shown to be not necessarily valid. Hence, Aura (1996) has modeled water fluxes around a single root in radial and longitudinal directions.

Diffusion transport

In all rhizosphere models the diffusion transport is considered as one of the major transport processes due to the occurrence of concentration gradients towards and from the root surface (depletion and accumulation, respectively). The diffusion fluxes are ion-specific as the ions have different self-diffusion coefficients that differ by up to one order of magnitude (Li and Gregory, 1974). In accordance with physical theory in multi-species models, which describe the simultaneous diffusion transport of several ions, diffusion transport of ions should be based on the Nernst-Planck equation (Newman, 1967). Due to the diffusion potential ionic interactions can occur which may clearly modify the self-diffusion fluxes of all ions involved (Oelkers, 1997; **51_Nietfeld**). In other multi-species models (Bouldin, 1989; Silberbush et al., 1993) the need to consider this process has been avoided by assuming identical diffusion coefficients for all ions involved. The transport of volatile chemical species in the gas phase is usually not considered because it is assumed that their concentration gradients are quickly equalized due to their high gas diffusion velocities. Hence, concentrations (partial pressure) of volatile species in the gas phase are given as pre-defined

constant values. For the transport of gaseous compounds in the soil solution the simultaneous equilibrium with the gas phase has to be considered (Nye, 1981; **51_Silk; 51_van Bodegom**).

Diffusion-convection transport

The plant-induced water flux in the rhizosphere soil are important for the matter transport towards the root as the flux of water carries the solutes dissolved in the soil solution. Therefore, existing rhizosphere models describe the ion transport in terms of diffusion flux and water movement (convective transport) towards the root (**51_Roose a; 51_Steingrobe; 51_Nietfeld**). Most existing rhizosphere-models assume a steady-state water flux indicating no changes of the soil water content in the rhizosphere. By linking the models of rhizosphere water and nutrient transport the effects of drying and rewetting around the root on supply (e.g. reduction of effective diffusion transport due to increase of soil tortuosity) and concentration of nutrients can be described. The non-linear relationship between hydraulic conductivity and the soil water content has consequences for the uptake of ions predominantly transported by mass flow via a reduced convective transport (**51_Roose a**).

5.1.2.3. Physical-chemical reactions

The transport of ions in the rhizosphere is modified by soil chemical reactions such as complex formation/dissociation in the soil solution (dissociation of acids, formation/dissociation of ion-pairs, etc.), transfer of volatile species between the gas and solution phase, ion exchange between species in solution and labile binding forms (e.g. cation exchange, anion exchange) and dissolution/precipitation of soil minerals. Usually, they are treated as 'fast' reactions', hence an equilibrium between transport and chemical reactions has to be calculated continuously.

Solution-gas phase equilibria

The dissolution of volatile species in liquid is controlled by Henry's law, i.e. the mass of a gas dissolved in a given volume of solution is proportional to the pressure of gas with which it is in equilibrium. The solubility is expressed by the distribution coefficient between liquid and gas phase (Stumm and Morgan, 1995) that may induce subsequent solution reactions. Thus, the total CO₂ is distributed among water and gas phase as a function of pH according to the chemical equilibrium for dissolution of CO₂, hydration of CO₂ to H₂CO₃ and the acid-base reaction of H₂CO₃ to HCO₃⁻ and CO₃²⁻. Considering these reactions is important for the calculation of the rhizosphere pH (**51_Silk**).

Cation exchange

The exchange between solution concentration and labile ion concentration on the soil solid phase follows up an isotherm that is mostly assumed to be linear in the concentration range of interest. This approach has been modified by using a Langmuir or Freundlich isotherm (**51_Steingrobe**) that describes a non-linear sorption. Cushman (1982, 1984) already modified the classic rhizosphere models by using a spatially and temporarily changing buffer power. In multi-species models the sorption/desorption behavior of cations is modeled according to the stoichiometric cation exchange. This approach describes for the cations involved a competition for the exchanger sites of the rhizosphere soil via the cation selectivity approach (**51_Nietfeld; 51_Nowack; 51_van Beinum**; Silberbush et al., 1993; Bouldin, 1989). The proportion of exchanger sites occupied by a given cation is determined not only by its own solution concentration but also by the concentrations of all other cations involved. Therefore, the competitive cation exchange reactions result in a non-linear sorption isotherm. Using the cation selectivity approach opposed concentration gradients in soil solution and soil exchanger can be calculated. Chung et al. (1994) have identified different selectivity coefficients

for rhizosphere and bulk soil. Also Cushman, (1982) divided the rhizosphere into an inner and outer rhizosphere (two connected porous media). It is assumed that the inner rhizosphere soil is characterized by root-related modifications (e.g. deposition of mucilages, mucigel, etc.) and hence other parameter values for describing the ion dynamics (e.g. for buffer power, bulk density, etc.) are used.

Anion exchange

In the existing classic rhizosphere models the sorption behavior of anions (e.g. phosphate, organic anions) is described by a constant buffering power (Kirk, 1999; **51_Claassen; 51_Steingrobe**). But more detailed approaches explicitly describe the fundamental effects of anion adsorption on charged (hydroxo)oxides surfaces in soils, e.g. via surface complexation. Surface complexation models provide molecular descriptions of adsorption phenomena using an equilibrium approach; the surface charge results from adsorption of various adsorptives including protons and electrolyte ions. The models define surface species, chemical reactions and their equilibrium constants, mass and charge balances and consider the charge of both, the adsorbate and the adsorbent (Goldberg, 1998; Goldberg, 1992; **51_VanBeinum**). These model approaches (e.g. the 1-pK model) have been used in several studies on the modeling of the adsorption of anions on goethite (phosphate and various organic anions; Filius et al., 1997) and this approach has been used to describe the competitive reactions between phosphate and root-released organic anions (Geelhoed et al., 1999).

Mineral dissolution/precipitation

Although enhanced mineral weathering due to plant impacts is discussed (Kelly et al., 1998) only few rhizosphere models have been developed that include these processes. They predominantly describe the solubilization of weakly soluble phosphorus minerals (**51_Kirk**). The model of Kirk (1999) integrates the

complex reactions between organic anions and phosphate by a 'lumped' parameter that also includes other processes. The dissolution/formation of minerals usually is described via their solubility product (Sposito, 1989), but the changes of the mineral composition in the rhizosphere may be considered as 'slow' reactions and may be better described via kinetic approaches for application in rhizosphere models (Ritchie, 1995). But the parameters of the kinetic reactions are incompletely validated by measurements (Oelkers, 1997). Hence, these reactions could be modeled as a semi-empirically reaction which describes the kinetically weighted deviation from the solubility product (Calba et al., 1999).

Solution complexes

The transport of ions in the soil solution is modeled considering the simultaneously occurring exchange with the soil gas or the soil solid phase; a transport in the soil solid phase or the in the gas phase usually are not considered. Modeling the solution transport of ions which are coupled via complex formation/dissociation has taken into account the transport of the ion complex in the soil solution as ion complexes usually have their own transport characteristics (e.g. self diffusion coefficients of organic-mineral complexes).

Acid-base reactions

The pH is a defining variable in the rhizosphere as rhizosphere pH may considerably differ from bulk soil. The underlying concept of modeling the rhizosphere pH changes is that the pH is calculated according to proton transfer reactions between mobile conjugate acid-base pairs present in the rhizosphere. The movement of an acid in one direction simultaneously implies the movement of the conjugate base in the opposite direction in the soil solution. Concurrently an acid-base equilibrium exists between the soil solution and the soil solid phase that buffers the acidity of the solution and influences the movement of acids and bases. In the existing models $\text{H}_3\text{O}^+ - \text{H}_2\text{O}$ and $\text{H}_2\text{CO}_3 - \text{HCO}_3^-$ are considered as the two major acid-base pairs present in the rhizosphere soil (**51_Silk**; Nye, 1981). In

addition to these pairs, other mobile acids and bases relevant in the rhizosphere chemistry are e.g. $\text{H}_2\text{PO}_4^- - \text{HPO}_4^{2-}$, $\text{Al}^{3+} - \text{Al-hydroxo-complexes } \text{Al}(\text{OH})_n^{3-n}$, and organic acids – organic acid anions.

Ion-complexes

The calculation of the rhizosphere pH may induce changes in the chemical binding-form of mineral ions via pH-dependent complex formation. In this regard acid-base pairs other than $\text{H}_2\text{CO}_3 - \text{HCO}_3^-$ can be considered, e.g. Al-hydroxo-complexes and also Al-sulfate complexes (**51_Nietfeld**). Furthermore, the behavior of root-exuded organic acids in the rhizosphere and the formation of Al-organic complexes can be modeled. Other models consider the complex formation between phosphorus and a root-excreted organic anion (**51_Claassen**). It describes the interaction between the mobile phosphorus species, organic anions and an organic P-complex; the interaction between these species is presented by equilibrium constants and all species involved are transported by diffusion and convection. In these previous models a degradation of organic anions due to microbial decomposition is not considered.

5.1.2.4. Microbially driven reactions

The biological reactions describe the activity of the rhizosphere microbial biomass and includes mineralization of root-exudates (coupled with aerobic respiration), transformation reactions of organic and inorganic nitrogen-compounds under aerobic soil conditions and growth and death of microbial biomass. A review of rhizosphere carbon flow modeling is given by Toal et al. (2000). Under anoxic bulk soil conditions the rhizosphere is characterized by a dynamic interface between aerobic and anaerobic conditions; its spatial extent is determined by the release of O_2 via the root and the O_2 consumption in the rhizosphere (e.g. oxidation of Fe^{2+}). A short introduction into the special characteristics of the relevant rhizosphere processes in anaerobic soils

is given in Tinker and Nye (2000; pp. 171 ff.).

Aerobic C-mineralization

The models describe the distribution of root-derived organic matter in the rhizosphere soil. The variety of root exudates is integrated into one single pool of organic matter or it is distinguished between mobile and immobile organic matter (Darrah, 1991). The growth and decay of microbial biomass (and its subsequent mineralization) in the rhizosphere is modeled. The movement of mobile organic matter is driven by diffusion; i.e. mass flow has been neglected. The model results show the concentration of organic matter around the root as affected by the interaction between the root exudation rate, the transport rate of mobile organic matter and the decomposition rate of the heterotrophic microbial biomass (**51_Kuzyakov**). Modeling microbial CO₂ production allows the separation and quantification of the respirations of root and microbial biomass (rhizorespiration; Hanson et al., 2000).

Nitrogen-transformations

In the model of Kirk and Kronzucker (2005) the denitrification in the rhizosphere is described as affected by the transport and uptake of NH₄ and NO₃. Nitrification in the rhizosphere is described by an NH₄-NO₃-transformation reaction that couples the transport of NH₄ and NO₃ according to the classic transport model thereby considering that NH₄ is sorbed by the soil solid phase (Kirk and Kronzucker, 2005). Denitrification is described as affected by concentrations of NO₃ and root-excreted O₂ in the soil solution.

Methane transformation

The model of van Bodegom (**51_VanBodegom**) describes the interactive processes leading to methane oxidation in rice rhizosphere. Diffusion transport of the mobile species (O₂, CH₄, CH₃COO⁻ (acetate), H₂, CO₂, HCO₃⁻, H₂CO₃, Fe²⁺ and H⁺) is combined with interrelated source/sink kinetics (Monod

kinetics) that reflects the competition of microbial transformation reactions. The major driving force is the diffusion of root-released oxygen and its consumption via oxidation and heterotrophic (acetate) and methanotrophic respiration. Substrates for these reactions (ferrous iron, acetate and methane) are produced by organic matter mineralization. The model is an illustrative example for both, the need of a sophisticated description of nearly all relevant rhizosphere processes (multi-species approach) and the methodical capability of recent model approaches to realize these needs.

5.1.2.5. Fluxes at the outer rhizosphere boundary

The outer boundary of the rhizosphere is considered not to be changed and retain the initial bulk values (infinite extent of rhizosphere). On the other hand, competition between adjacent roots for nutrients is considered as the flux of nutrients at the outer boundary is set to zero (finite rhizo-cylinder). The extent of the finite rhizo-cylinder is derived from the root length density. But the size of the finite rhizosphere varies during the growth of the root system in a defined soil volume. Hence, the outer boundary has to be recalculated with changing root densities (Hoffland et al., 1990).

5.1.2.6. Model simulation results

Radial concentration changes in the rhizosphere at various points in time or temporal changes at the root surface are the results of rhizosphere model calculations mostly reported in the literature. For nutrient uptake models the actual cumulative uptake under consideration of the rhizospheric processes is calculated as it deviates from the potential uptake rate.

Transient state models

The existing models calculate the transient state of the spatial concentration gradients of nutrients around the root and thereby the actual uptake rate by the root. With the process of time the differences

between subsequent concentration gradients will become smaller and for large time periods a dynamic equilibrium between root uptake and transport will be established.

Steady state models

Steady state models calculate a time-invariant concentration gradient around the root. They may be considered as a special case of the transient state models, mostly of the classic nutrient uptake models, and the resulting concentration profiles indicate how much of a nutrient can be potentially taken up from the rhizosphere soil. The steady-state model of Yanai (1994) calculates uptake rates allowing at the same time changes of various parameters, such as water content, root growth rate and radial distance to the adjacent roots.

Solution methods

For some of these models analytical solution expressions have been formulated (**51_Roose_a**) but for most other models numerical methods are required. The most applied solution method of partial differential equations is the finite-difference technique that transforms the differential equations into a difference scheme on the basis of a given grid of points in space and time (**51_Schnepf**). Alternatively, the finite-element approach offers a method – especially for irregular domains – to solve partial differential equations.

5.1.2.7. References

Aura, E. 1996. Modeling non-uniform soil water uptake by a single plant root. *Plant Soil* 186: 237-245.

Barber, SA. 1995. *Soil Nutrient Bioavailability. A Mechanistic Approach*. Wiley, N.Y.

Bouldin, D.R. 1989. A multiple ion uptake model. *J. Soil Sci.* 40: 309-319.

Calba, H.; Cazevielle, P.; Jaillard, B. 1999. Modeling of the dynamics of Al and protons in the rhizosphere of maize cultivated in acid substrate. *Plant Soil* 209: 57-69.

Chung, J.B.; Zasoski, R.J.; Buran, R.G. 1994. Aluminum-potassium and aluminum-calcium

exchange equilibria in bulk and rhizosphere soil. *SSSAJ* 58: 1376-1382.

Cushman, J.H. 1982. Nutrient transport inside and outside the root rhizosphere: Theory. *SSSAJ* 46: 704-709.

Cushman, J.H. 1984. Nutrient transport inside and outside the root rhizosphere: Generalized model. *J. Soil Sci.* 45: 165-171.

Darrah, P.R. 1991. Models in the rhizosphere. I. Microbial population dynamics around a root releasing soluble and insoluble carbon. *Plant Soil* 133: 187-199.

Darrah, P.R. 1993. The rhizosphere and plant nutrition: a quantitative approach. *Plant Soil* 155/156: 1-20.

Filius, J.D.; Hiemstra, T.; van Riemsdijk, W.H. 1997. Adsorption of small weak organic acids on goethite: Modeling of mechanisms. *J. Colloid Interface Sci.* 195: 368-380.

Geelhoed, J.S.; van Riemsdijk, W.H.; Findenegg, G.R. 1999. Simulation of the effect of citrate excuaction from roots on the plant availability of phosphate adsorbed on goethite. *Europ. J. Soil Sci.* 50: 379-390.

Goldberg, S. 1992. Use of complexation models in soil chemical systems. *Adv. Agron.* 47: 233-329.

Goldberg, S. 1998. Ion adsorption at the soil particle-solution interface: modelling and mechanisms. In: Huang, P.M.; Senesi, N.; Buffle, J. (Eds.) *Structure and Surface Reactions of Soil Particles*. Wiley&Sons, Chichester, pp. 377-412.

Grignon, C.; Sentenac, H. 1991. pH and ionic conditions in the apoplast. *Annu. Rev. Plant Physiol. Plant Mol. Biol.* 42: 103-128.

Hanson, P.J.; Edwards, N.T.; Garten, C.T.; Andrews, J.A. 2000. Separation root and soil microbial contributions to soil respiration: A review of methods and observations. *Biogeochemistry* 48: 115-146.

Häussling, M.; Jorns, C.A.; Lehmbecker, G.; Hecht-Buchholz, C.; Marschner, H. 1988. Ion and water uptake in relation to root development in Norway spruce (*Picea Abies* (L.) Karst.). *J. Plant Physiol.* 133: 486-491.

Hoffland, E.; Bloemhoff, H.S.; Laffelaar, P.A.; Findenegg, G.R.; Nelemans, J.A. 1990. Simulation of nutrient-uptake by a growing root-system considering increasing root density and interroot competition. *Plant Soil* 124: 149-157.

Jones, D. 1998. Organic acids in the rhizosphere – a critical review. *Plant Soil* 205: 25-44.

Kelly, E.F.; Chadwick, O.A.; Hilinksi, T.E. 1998. The effect of plants on mineral weathering. *Biogeochemistry* 42: 21-53.

Kirk, G. 1999. A model of phosphate solubilisation by organic anion excretion from plant roots. *European J. Soil Sci.* 50: 369ff.

Kirk, G. 2003. Rice root properties for internal aeration and efficient nutrient acquisition in submerged soil. *New Phytol.* 159: 185-194.

Kirk, G.J.D.; Kronzucker, H.J. 2005. The potential for nitrification and nitrate uptake in the rhizosphere of wetland plants: A modeling study. *Ann. Bot.* 96: 639-646.

Li, Y.L.; Gregory, S. 1974. Diffusion of ions in sea water and deep-sea sediment. *Geochim. Cosmochim. Acta* 38: 703-714.

Meychik, N.R.; Yermakov, I.P. 2001. Ion exchange properties of plant root cell walls. *Plant Soil* 234: 181-193.

Newman, J. 1967. Transport processes in electrolyte systems. In: Tobias, C.W. (ed.). *Advances in Electrochemistry* 5, Wiley, London, pp. 87-136.

Nye, P. 1981. Change of pH across the rhizosphere induced by roots. *Plant Soil* 61: 7-26.

Oelkers, E.H. 1997. Physical and chemical properties of rocks and fluids for chemical mass transport calculations. In: Lichtner et al. (eds.) *Reactive Transport in Porous Media*, Rev. in Mineral. 34, Mineral. Soc. Am., Washington, DC.

Ritchie, G.S.P. 1995. Soluble aluminium in acidic soils: Principles and practicalities. *Plant Soil* 171 17-27.

Rubin, J. 1983. Transport of reacting solutes in porous media: relation between mathematical nature of problem formulation and chemical nature of reaction. *Water Res. Res.* 9: 1332-1356.

Schnepf, A.; Roose, T. 2006. Modelling the contribution of arbuscular mycorrhizal fungi to plant phosphate uptake. *New Phytol.* 171: 669-682.

Silberbush, M.; Sorek, S.; Yakirevich, A. 1993. K uptake by root systems in soil under salinity: I. A mathematical model. *Transp. Porous Media* 11: 101-116.

Sposito, G. 1989. *The Chemistry of Soils*. Oxford Univ. Press

Steudle, E. 2000. Water uptake by plant roots: an integrated view. *Plant Soil* 226: 45-56.

Stumm, W.; Morgan, J.J. 1995. *Aquatic Chemistry: Chemical Equilibria and Rates in Natural Waters*. Wiley-Interscience Publ., 1024 pp.

Tinker, P.B.; Nye, P. 2000. *Solute movement in the rhizosphere*. Oxford Uni. Press.

Toal, M.E.; Yeomans, C.; Kollham, K.; Meharg, A.A. 2000. A review of rhizosphere carbon flow modeling. *Plant Soil* 222: 263-281.

Trapp, S. 2003. Plant uptake and transport models for neutral and ionic chemicals. *Environ. Sci. Pollut. Res.* 1: 1-7.

de Willigen, P.; van Noordwijk, M. 1994. Mass flow and diffusion of nutrients to a root with constant or zero-sink uptake. II. Zero-sink uptake. *Soil Sci.* 157: 171-175

Yanai, R.D. 1994. A steady-state model of nutrient uptake accounting for newly grown roots. *SSSAJ* 58: 1562-1571.

5.1.2.8. Related method sheets

ID	51_Claassen
Parameter	Effect of complexing root exudates on transport and uptake of soil nutrients
Soil type	Any
Plant species	Any
Model type	Mechanistic model

ID	51_Kirk
Parameter	Buffer powers and interaction coefficients for solutes that influence each others solubilities
Soil type	Any
Plant species	Any
Model type	Chemical equilibrium – transport model on the individual root level

ID	51_Kuzyakov
Parameter	Separation of root respiration and rhizomicrobial respiration in non-sterile soil
Soil type	Not useful for alkaline soils
Plant species	Crops, grassland. Not useful for trees.
	Microcosm, controlled conditions
Model type	Modeling of ¹⁴CO₂ efflux dynamics for separation of root and rhizomicrobial respiration

ID	51_Nietfeld
Parameter	Concentration gradients in rhizosphere soil solution and soil exchanger of major ions (including protons)
Soil type	Any
Plant species	Any
Model type	Multispecies rhizosphere model on the single root level

ID	51_Nowack
Parameter	Modelling rhizosphere processes
Soil type	Any
Plant species	Any
Model type	Coupled speciation-transport models

ID	51_Roose_a
Parameter	Plant nutrient uptake, single root scale
Soil type	Any
Plant species	Any
Model type	Mathematical Modeling; Analytical approximations

ID	51_Schnepf
Parameter	Concentration gradients of solutes in the rhizosphere, solute uptake by roots
Soil type	Any
Plant species	Any
Model type	Use of pde-solvers (FlexPDE); Single root scale

ID	51_Silk
Parameter	Chemical fields in the rhizosphere
Soil type	Any
Plant species	Any
Model type	Root efflux coupled with transport

ID	51_Steingrobe
Parameter	Modelling nutrient transport in soil and plant uptake
Soil type	Any
Plant species	crop species
Model type	NST 3.0; transport model

ID	51_VanBeinum
Parameter	Concentration gradients of solutes in the rhizosphere, solute uptake by roots
Soil type	Any
Plant species	Any
Model type	ORCHESTRA, a coupled chemical equilibrium – transport model; single root scale

ID	51_VanBodegom
Parameter	Modelling methane oxidation in the rhizosphere
Soil type	Any, anoxic conditions
Plant species	adapted to anoxic conditions
Model type	Numerical modelling

5.1.3. Bottom-up and top-down approaches

The resource exchange of the plant with its environment and the resource partitioning within the plant (e.g. photosynthesis, mineral nutrient uptake, storage and allocation of resources, root growth) are characterized by the physiologically driven requirements of the plant for growth and maintenance and the plant's continuous adaptation to changing environmental conditions. This feedback system is described – in some aspects - by the whole-plant models but mainly with focus on the soil resources influxes/effluxes via the active root system. Formally, the whole-plant nutrient uptake (cumulative uptake) can be described by the product of the active (absorbing)

surface of the rooting system and the actual nutrient influx per unit of surface calculated under rhizosphere conditions. But both of these factors are highly environmentally responsive entities and may change spatially and temporarily, e.g. due to

- changes in the nutrient demand of the plant as affected by its physiological status, i.e. changes of the potential nutrient uptake rates per unit root surface (uptake plasticity)
- growth (allocation of resources to root system) and life-span of roots (possibly affected by unfavorable soil conditions)
- functional and morphological differences in the active rooting system (heterogeneity of absorbing rooting system, root architecture; Pierret et al., 2005)
- plastic distribution of roots in the soil as determined by nutrient patchiness and soil constraints (modification of rooting architecture; Hodge, 2004)
- the spatial-temporal patterns of reactive solution transport in the whole rooting space (heterogeneity of bulk soil conditions)

These processes may produce a heterogeneous pattern of rhizosphere conditions by changing the values of the boundary and initial conditions in rhizosphere model calculations and the resulting differences in the rhizosphere conditions may result in changes of cumulative uptake rates of soil resources.

The *bottom-up approach* in its classic, most simple version of calculating the cumulative plant uptake of a nutrient by a root system is the integration over time of the influxes into a single linearly and exponentially growing root thereby considering the continuous change of the root age. In this approach the growth of the whole root system is modelled by the length-growth of one single root and the total cumulative uptake is calculated by the summation of the uptake rates of each root age class. This approach has been largely realized in existing applications of

rhizosphere models (Barber, 1995; p. 118).

In a *top-down* approach rhizosphere effects are included or are calculated in the whole-plant models (macroscopic models). These models describe both, the water and nutrient dynamics in the rooting space and the spatial-temporal growth dynamics of the root system. They may be divided into models that mainly focus on the description of the transport dynamics of resources in the rooting space (heterogeneity of resources availability) and models that focus on the plant-internal allocation of resources (heterogeneity of plant demand, growth and heterogeneity of absorbing root system, etc.). The first category of models is presented in Tinker and Nye, (2000; chapter 10). The more plant-focused models describe the growth effects of mineral nutrients taken up via the absorbing root system under consideration of its architecture and often they are combined with the acquisition and allocation of carbohydrates. By modeling resource allocation within the plant, e.g. including a variable shoot-root ratio, these models can specify the demand of the plant and its change more concisely. This category of models is presented in Tinker and Nye, (2000; chapter 9). The chapter also includes factors that influence the appearance of the genotypically driven root system by various soil conditions (heterogeneity of soil resources and soil constraints).

The classic applications of both of these model approaches have strong structural limitations: upscaling of rhizosphere models includes more than an integration of single-root effects and any heterogeneity of the absorbing root system (various root diameters, morphological differences between root types, differences in the potential uptake rates of root classes, different life-spans of root categories) and changes of the bulk soil concentrations are not considered. In the classic macroscopic approaches, rhizosphere processes usually are not included, e.g. in its basic version a sink term in the mass balance equations tend to parameterize the root influxes in a simple, empirically defined way only

depending on the rooting density in each soil depth layer.

Recently developed approaches describe these processes in a more sophisticated way. Both of these model classes include the calculation of rhizosphere processes. In the top-down approaches the calculation of rhizosphere effects are included in the sink/source terms of the mass balance equations of the whole-plant models while the upscaling of rhizosphere conditions (bottom up approach) is given as part of the model structure. Furthermore, both classes of models include a detailed description of the active rooting system with respect to its morphological characteristics and heterogeneous growth patterns.

5.1.3.1. Upscaling of rhizosphere models

The previous upscaling procedures of rhizosphere models mostly consider the treatment of the heterogeneity of the absorbing root system. Growth and activity of the root system is described (i) via an explicit simulation of the architecture of the root system in various dimensions which offer the opportunity to incorporate rhizosphere volumes around each root or (ii) by application of the continuum approach that ignores architectural features and where only the amount of roots per unit soil volume is specified. In other upscaling procedures of rhizosphere models the heterogeneity of the nutrient distribution within the rooting zone is taken into account (Jackson and Caldwell, 1996).

Cumulative nutrient uptake using rooting architecture

The uptake of nutrients is highly sensitive to root diameter; hence one deficiency of the treatment of root growth in the classic upscaling procedure is the assumption of a constant root diameter. The architecture of a root system of a plant supplies various orders of roots characterized by decreasing root diameter values at increasing branching level. An extension of the existing calculation of the

cumulative nutrient uptake is the generation of a population of roots of different diameters and ages thereby calculating the cumulative uptake for each class (**51_Roose_b**). The results show that the classic calculation method of radius averaging underestimates the cumulative uptake.

Cumulative nutrient uptake using continuum approach

The cumulative root uptake can be calculated on the basis of a growth development of the rooting system based on the continuum approach (**51_De Willigen**). These models have no fundamental physiological background but the main advantage of these approaches is that they can explicitly consider root plasticity. This is realized by making the 'root growth diffusion coefficient' a function of soil conditions.

5.1.3.2. Downscaling in whole-plant models

There are several independently developed model approaches that have included more sophisticatedly rhizosphere effects in the source/sink-term of whole-plant models (in the mass balance equations). These models describe water and nutrient transport usually in one or several dimensions including a detailed consideration of the rooting architecture. The local root influxes/effluxes based on the local availability of water and nutrients are calculated. In some models the rooting architecture, its growth and proliferation on water and nutrient availability is included. But a reduced root lifespan due to unfavorable rhizosphere soil conditions usually are not included in such models. Appropriate approaches could predict reductions of cumulative uptake rates which do not meet the demand of the plant. The turnover of rooting biomass has been modeled by Darrah and Staunton (2002). The included method sheets show examples of models that incorporate the calculation of rhizosphere processes and include the integration of these effects to the whole-plant level.

Water transport and root water uptake

For modelling the water absorption by the root system the vertical dynamics of water within the whole rooting space is considered by using the Richards equation. The use of an empirical root water extraction function is avoided by coupling with a single root approach (microscopic model of radial water flow) via considering rhizospheric cylinders around single roots in the soil layers. For each horizontal soil layer the model of radial water fluxes is solved (**51_Doussan**). A similar approach has been used by Personne et al. (2003). The water flow is calculated under the assumption of a predefined rooting architecture.

Coupled water/nutrient transport and root uptake

In modelling the plant water and nutrient uptake a coupling of the dynamics of the fluxes of water and nutrients in the soil in three spatial dimensions have been used (**51_Hopmans**). The basis of the modeling approach is to create a three-dimensional architecture of the plant-specific root system. Roots grow at user-defined time-intervals with a new segment added to the apex of each growing root. The model tracks each segment by recording its topological position within the root system. The sink-term for root nutrient uptake is proportional to the solution concentration and is divided into a passive and active uptake rate. Root elongation is affected by temperature, soil strength and nutrient concentration when these properties fall outside an optimum range, and the resultant elongation is scaled according to the amount of biomass allocation to the root system.

Nutrient transport, root uptake and root-derived organic anions

Multi-species models also on the whole-plant level offer the opportunity to simulate the interactions between root-exuded organic anions and the uptake of cations under consideration of rhizospheric interactions. In the coupled transport equations the vertical dispersion-

convection transport of metals, root-derived organic anions and organic metal complexes are described. In the equations the roots act as both, source for the organic anion and sink for the metal. The model couples multi-species rhizosphere processes such as diffusion, uptake kinetics, exudation of organic ligands and ligand-metal interactions with the convection-dispersion transport of the species involved. This interaction is realized by a planar root surface whose size is equivalent to the measured root surfaces in the particular soil segments. The changes of the availability of the ion considered in the rhizosphere as affected by the root excretion of organic ligands are calculated under consideration of the vertical transport of the species (**51_Seuntjens**).

Transport and uptake of Water and nutrients and the allocation of resources to root systems

A three-dimensional root growth has been modeled to simulate the interactions between root systems, water and nutrients in the rooting space. The model uses the plant demand for individual resources and the ability of various components of the plant to supply individual resources to drive the allocation of endogenous assimilates and subsequent root growth, architectural development and nutrient uptake rates. A rhizosphere soil volume is defined around all roots in which the rhizospheric transport processes are considered in detail (**51_Dunbabin**).

5.1.3.3. References

Barber, SA. 1995. Soil Nutrient Bioavailability. A Mechanistic Approach. Wiley, N.Y.

Darrah, P.R.; Staunton, S. 2000. A mathematical model of root uptake of cations incorporating root turnover, distribution within the plant and recycling of absorbed species. *Europ. J. Soil Sci.* 51: 643-653.

Hodge, A. 2004. The plastic root: root responses to heterogeneous supplies of nutrients. *New Phyt.* 162: 9-24.

Jackson, R.B.; Caldwell, M.M. 1996. Integrating resource heterogeneity and plant plasticity: modeling nitrate and phosphate uptake in a patchy soil environment. *J. Ecology* 84: 891-903.

Personne, E.; Perrier, A.; Tuzet, A. 2003. Simulating water uptake in the root zone with a microscopic-scale model of root extraction. *Agronomie* 23: 153-168.

Pierret, A.; Moran C.J.; Doussan, C. 2005. Conventional detection methodology is limiting our ability to understand the roles and functions of roots. *New Phyt.* 166: 967-980.

Tinker, P.B.; Nye, P. 2000. Solute movement in the rhizosphere. Oxford Uni. Press.

5.1.3.4. Related method sheets

ID	51_DeWilligen
Parameter	Description of rooting patterns as generated by a diffusion process
Soil type	Arable soils, artificial root media (e.g. rockwool)
Plant species	Field crops (leeks, wheat, maize, cedar), Ornamental crops (Thuja) Glasshouse crops (tomato)
System	Field soil, greenhouse
Method	Root length measurement with pinboard and numerical root distribution model

ID	51_Doussan
Parameter	Soil water content/gradients from the rhizosphere to root system scales; Root water uptake and flow within the root system
Soil type	Any
Plant species	Any; but species tested so far: maize, narrow leaf Lupin, peach tree
System	Single root to whole root system scales
Model type	Water uptake and transfer in the soil-root system coupled with root system architectural modelling

ID	51_Dunbabin
Parameter	Water and solute transport to, and uptake from rhizosphere soil by plant roots
Soil type	Any
Plant species	Annual species with fibrous root systems
Model type	ROOTMAP, three dimensional root architectural model

ID	51_Hopmans
Parameter	Plant water and nutrient uptake in soil-root systems
Soil type	Any
Plant species	Any
Model type	Numerical modeling of root architecture coupled with unsaturated soil water flow and nutrient transport; whole plant level

ID	51_Roose_b
Parameter	Plant nutrient uptake
Soil type	Any
Plant species	Any
Model type	Mathematical modelling; analytical approximations; multiscale homogenization of root branching structures and soil processes

ID	51_Seuntjens
Parameter	Root-zone uptake and leaching of trace elements in the presence of organic ligands
Soil type	Generic model soil consisting of quartz sand with 2% goethite
Plant species	Generic model plant
System	Soil column
Model type	Speciation and transport modeling

5.1.4. Sensitivity analysis and validation of rhizosphere models

Sensitivity analysis is a study of how the uncertainty of the model output can be assigned to different sources of uncertainty in the model input. It is aimed to identify the most sensible parameter in any model to the performance of the model output, i.e. to determine which input factors propagate most variance in the output and therefore are needed to be measured most exactly. Sensitivity analysis methods can be classified in local and global methods that are presented in detail, e.g. Saltelli et al. (2000).

Local sensitivity methods evaluate the effect on model outputs by individually varying only one of the model inputs across its entire range of plausible values while holding all other inputs at their nominal or base-case values. This is also known as one-at-a-time (OAT) analysis. The results of a local sensitivity analysis can be provided in 'spider diagrams' in which the ratios of the changes in the output to that in the parameters are shown. They provide a simple measure of sensitivity and ratios appreciably greater or less than unity suggest sensitivity and insensitivity, respectively. A local sensitivity analysis of the classic nutrient uptake model has been conducted for several nutrients (e.g. Barber, 1995; pp. 127 ff.) in which the ratio of the change actual nutrient uptake to that in the parameter provides a degree of sensitivity

and has been conducted to date in numerous other investigations (Yakirevich et al., 1994; see also ref. in **51_VanBodegom**).

In contrast, *global sensitivity analysis* methods consider that the relative importance of parameters can depend strongly on the values of the other parameters. An uncertainty analysis is carried out in which the effect of a factor is evaluated while all other factors are also varying. A global sensitivity analysis usually takes into account simultaneous interactions among multiple inputs and may therefore provide more robust insights than methods without these features. There are several global sensitivity methods, e.g. analysis of variance and the Monte-Carlo method. A sensitivity analysis based on the analysis of variance has been carried out for a steady state rhizosphere model (Williams and Yanai, 1996). A Monte Carlo uncertainty analysis typically involves five stages: (i) the selection of model inputs and outputs on which the analysis will be performed; (ii) the attribution of variation ranges and probability distributions of each parameter selected (e.g. range of maximum root uptake rates) and the specification of their correlation; (iii) the generation of a random sample from the distributions assigned to parameters; (iv) the running of the rhizosphere model for each of sample elements, and (v) the examination of model predictions in statistical terms (e.g. actual nutrient uptake rate, etc.). The effect of a highly heterogeneous soil environment on nutrient uptake was simulated using measured-based frequency allocations of nutrient bulk concentrations thus considering the patchiness of soil resources to produce a heterogeneous pattern of actual root uptake rates (Ryel and Caldwell, 1998). This method has also been applied in an assessment of pesticide application (Carbon et al., 2001).

Validation is, in general, a demonstration that a model within its domain of applicability possesses a satisfactory range of accuracy consistent with the intended application of the model (Rykiel, 1996; Schlesinger et al., 1979). This demonstration indicates that the

model is acceptable for use, not that it implies any absolute truth, nor even that it is the best model available. From an operational view point, validation is a demonstration in terms of the degree of correlation between simulated data created by model calculations and independently obtained data from observation and measurement of the real system. Validation demonstrates that a model meets some specified performance standard under specified conditions. It is often overlooked that the specified conditions include all implicit and explicit assumptions about the real system the model represents as well as the environmental context. It should be noticed that there do not exist unique criteria that have to be met by a model validation.

An ideal concept of validation of rhizosphere model calculation results would be able to compare the rhizosphere measurement results with model simulation results under known initial and boundary conditions; i.e. it would relate measurements of the cumulative root influxes/effluxes of resources of a single root to simultaneously conducted measurements of the changes of these resources (concentrations, water potential, etc.) in the rhizosphere. This is in accordance to the definition of the rhizosphere and the conceptual design of the rhizosphere models. But currently, such a validation approach can not be accomplished. Although recently measurement techniques have been developed which offer measurements in soil micro-sites, a validation of rhizosphere models in their given design is still a challenge because appropriate measurement methods should be able to produce data in a spatial resolution which is clearly below the mm-range. As a consequence, a validation of rhizosphere models can be realized only by a coordinated constellation of single measurements any of which measures only a selection of essential processes.

Measurements on single root level in 'artificial' non-soil root environment

Investigations in hydroponic systems (non-rhizosphere systems) have been used to determine influxes/effluxes at the root surface even separated for various root absorption zones (Häussling et al., 1988). They may be appropriate to quantify the apoplastic processes on actual nutrient uptake especially under the influence of e.g. potentially toxic elements. Furthermore, these effects can be studied under the chemical conditions similar to the root surface concentrations derived from rhizosphere model calculations. Measurements of rhizospheric changes around roots grown in artificial non-soil environments can show the spatial-temporal dynamics of the changes if the ion transport characteristics of the medium are parameterized, e.g. movement of protons (Jaillard et al., 1996).

'External' validation of single rhizospheric processes

This approach can be used to validate single processes believed to be essential in the rhizosphere dynamics. This has been widely realized in analyzing the diffusion transport in soils (Jungk and Claassen, 1997) and possibly can be applied for the determination of parameter values of other driving forces (sorption behavior of ions, growth dynamics of microbial biomass, etc.). Furthermore, these experiments can be used to experimentally simulate the impact of the root (simultaneous influxes/effluxes of resources) on its surrounding soil environment.

Operational rhizosphere

These experimental systems are characterized by separating the soil from the roots by membranes impenetrable to roots but penetrable to nutrients and water. The growth of plant roots is often reduced to a single root-mat. The adjacent soil is considered as the (one) rhizosphere soil ('Big rhizosphere' approach) and the interface root-mat/soil is considered as the inner rhizosphere boundary. This 'enlargement' of the rhizosphere offers the

opportunity to measure the rhizospheric changes as affected by root (plant) impact in a measurable spatial-temporal resolution. Hence, this experimental system meets the requirements postulated for a validation of rhizosphere models. On one hand, any heterogeneous patterns of rhizosphere conditions are completely eliminated but on the other hand, this experimental system can be used to quantify rhizosphere effects at various bulk conditions thereby experimentally simulating the effects of changing bulk conditions in the rhizosphere of 'free-rooting' plants. For modeling the plant-induced changes the rhizosphere models have to be adapted to the experimental conditions (e.g. cartesian coordinates instead of radial coordinates). This experimental system has been widely used for studying rhizosphere conditions and for the validation of rhizosphere models (Vetterlein and Jahn, 2004; Claassen, 1994, Zhang and George, 2002; Wenzel et al., 2001; Calba et al., 2004).

References

- Barber, SA. 1995. Soil Nutrient Bioavailability. A Mechanistic Approach. Wiley, N.Y.
- Calba, H.; Firdaus; Cazevielle, P.; Thee, C.; Poss, R.; Jaillard, B. 2004. The dynamics of protons, aluminum, and calcium in the rhizosphere of maize cultivated in tropical acid soils: experimental study and modelling. *Plant Soil* 260: 33-46.
- Carbon, J. P.; Havens, P.L.; Warren-Hicks, L. 2001. Validation of pesticide root zone model – employing uncertainty analysis. *Environm. Toxicology and Chemistry* 21(8): 1578-1590.
- Claassen, N. 1994. Nährstoffaufnahme höherer Pflanzen aus dem Boden. Ergebnis von Verfügbarkeit und Aneignungsvermögen. Severin Verlag, Göttingen, 372 pp.
- Häussling, M.; Jorns, C.A.; Lehmbecker, G.; Hecht-Buchholz, C.; Marschner, H. 1988. Ion and water uptake in relation to root development in Norway spruce (*Picea Abies* (L.) Karst.). *J. Plant Physiol.* 133: 486-491.
- Jaillard, B.; Ruiz, L.; Arvieu, J.C. 1996. The pH mapping in transparent gel using colour indicator video-densitometry. *Plant Soil* 183: 85-95.
- Jungk, A.; Claassen, N. 1997. Ion diffusion in the soil-root system. *Adv. Agron.* 61: 53-102.
- Ryel, R.J.; Caldwell, M.M. 1998. Nutrient acquisition from soils with patchy nutrient distributions as assessed with simulation models. *Ecology* 79: 2735.

Rykiel, E.J. 1996. Testing ecological models: the meaning of validation. *Ecolog. Mod.* 90: 229-244.

Saltelli, A.; Chan, K.; Scott, E.M. 2000 (eds.) *Sensitivity Analysis*. Wiley, N.Y.

Schlesinger et al. 1979. Terminology for model credibility. *Simulation* 34: 101-105.

Vetterlein, D.; Jahn, R. 2004. Combination of micro suction cups and time-domain reflectometry to measure osmotic potential gradients between bulk soil and rhizosphere at high resolution in time and space. *Europ. J. Soil Sci.* 55: 497-504.

Wenzel, W.W.; Wieshammer, G.; Fritz, W.J.; Puschenreiter, M. 2001. Novel

rhizobox design to assess rhizosphere characteristics at high spatial resolution. *Plant Soil* 273: 37-45.

Williams, M.; Yanai, R.D. 1996. Multi-dimensional sensitivity analysis and ecological implications of a nutrient uptake model. *Plant Soil* 180: 311-324.

Yakirevich, A.; Sorek, S.; Silberbush, M. 1994. K⁺ uptake by root systems grown in soil under salinity: II. Sensitivity analysis. *Transp. Porous Media* 14: 123-141.

Zhang, J.; George, E. 2002. Changes in the extractability of cations (Ca, Mg, K) in the rhizosphere soil of Norway spruce (*Picea abies*) roots. *Plant Soil* 243: 209-217.

5.1.5. Final comments

- Multi-species models should be advanced. This includes especially the calculation of rhizosphere pH that is a major factor for the availability of many nutrients. Also the release of organic acids and the subsequent rhizosphere soil reactions can be modeled more sophisticated via a multi-species model approach.
- There is a need to reexamine the formulation of the inner boundary. The fixation of the soil/root interface as a simple uniform inner boundary layer of the rhizo hollow-cylinder does not reflect the irregular characteristics of the interface under natural conditions (Hinsinger et al., 2005). This also includes the consideration of root hairs (Gilroy and Jones, 2000) and especially the consideration of mycorrhizal fungi, but e.g. ectomycorrhizal roots have a poorly defined boundary to the surrounding soil due to the irregular distribution of the hyphae.

- The previous formulation of the root boundary explicitly disregards the role of the root apoplast. The consideration of the root apoplast as a reacting porous medium (Sattelmacher, 2001) should also be used to improve the fixation of the inner boundary in previous rhizosphere models. This could be realized by considering the rhizosphere as a medium consisting of two composed porous media (root apoplast and soil) with various characteristics. Also, the resources exchange between mycorrhiza and the root is not included in rhizosphere model approaches.
- Modeling the matter dynamics around single roots should be improved under consideration of the growth dynamics (elongation rate) of a single root (see **51_Silk**). There exist dynamic changes of influxes/effluxes result from changes in the root absorption zones; e.g. the root apex and the subsequent root basal zone behave differently thereby producing different ion-specific concentration gradients in their rhizospheres. The gradients created by the root apex of longitudinal growing of single roots have to be considered as the initial conditions of the rhizosphere of the basal root zones.
- For a validation of the modeling results on the single-root level previous rhizosphere-models are too restrictive in their given design, e.g. the radial-symmetry. The rhizosphere models should be formulated in two spatial dimensions (radial and longitudinal

dimension). For a validation of rhizosphere models measurements of the water and nutrient root-influxes on the level of single root-segments are required (see Coners, 2001, Bassirirad, 2000).

- For an incorporation of rhizosphere processes in field scale models simplified model approaches should be developed that represent aggregated descriptions of the major rhizosphere processes. Appropriate methods have been developed (Rastetter et al., 1992).

References

- Bassirirad, H. 2000. Kinetics of nutrient uptake by roots: responses to global changes. *New Phyt.* 147: 155-170.
- Coners, H. 2001. Wasseraufnahme und artspezifische hydraulische Eigenschaften der Feinwurzeln von Buche, Eiche und Fichte: *In-situ* Messungen an Altbäumen. Ph.D. thesis, Univ. Göttingen.
- Gilroy, S.; Jones, D.L. 2000. Through form to function: root hair development and nutrient uptake. *Trends Plant Science* 5(2): 56-60.
- Hinsinger, P.; Gobran, G.; Gregory, P.J.; Wenzel, W.W. 2005. Rhizosphere geometry and heterogeneity arising from root-mediated physical and chemical processes. *New Phyt.* 168: 293-303.
- Rastetter, E.B.; King, A.W.; Cosby, B.J.; Hornberger, G.M.; O'Neill, R.V.; Hobbie, J.E. 1992. Aggregating fine-scale ecological knowledge to model coarser-scale attributes of ecosystems. *Ecol. Appl.* 2(1): 55-70.
- Sattelmacher, B. 2001. The apoplast and its significance for plant mineral nutrition. *New Phytol.* 149: 167-192.

Schnepf, A.¹⁾; Gaisbauer, W.³⁾; Riedler, C.¹⁾; Draxl, B.¹⁾; Himmelbauer, M.²⁾; Loiskandl, W.²⁾; Wenzel, W.W.¹⁾

- 1) Department of Forest and Soil Sciences, Institute of Soil Science, University of Natural Resources and Applied Life Sciences, Peter Jordan Strasse 82, A-1190 Vienna, Austria.
- 2) Department of Water, Atmosphere, and Environment, Institute of Hydraulics and Rural Water Management, University of Natural Resources and Applied Life Sciences, Muthgasse 18, A-1190 Vienna, Austria.
- 3) Flüschezzone Atteneder & Gaisbauer OEG, Tegetthoffstr. 19, 4020 Linz, Austria.

andrea.schnepf@boku.ac.at; <http://rhizo.boku.ac.at/indexNew.html>

Rhizosphere models are useful tools for studying rhizosphere processes occurring in plant nutrient or contaminant acquisition or carbon flow and microbial dynamics in the rhizosphere. Access to information on model equations and input parameter values will facilitate the use of rhizosphere models. We propose the database ModellInfo that will enable to share continuously actualized information with the research community.

This database provides information on published rhizosphere models, their underlying equations, assumptions and input parameter values. It contains published information on rhizosphere models at the local scale up to the year 2000 and is available at <http://rhizo.boku.ac.at/indexNew.html>.

However, the internet version is still under construction with regard to input of new information as well as the option of viewing the underlying model equations. We present this database to the members of COST 631 with the goal that it shall be further improved and updated.

ModellInfo is a relational database including the entities Model name, Model Author(s), Application area of a model, Model scale, Model Parameters, Type of Model Parameter, Parameter Units, Model assumptions, Description of a model, References and Keywords (Fig. 1). Upon login, the list of Models included in the database is displayed (Fig. 2). Alternatively, the entries of the Tables **Keyword**, **Scale**, **Application Area**,

Parameter, **Reference**, **Parameter Type** and **Unit** can be accessed by clicking on the respective link (e.g. Fig. 3). A search option is provided, the individual terms may be linked by the AND or OR operator (Fig. 4). Each model can be accessed by clicking on the respective link, upon which information about the model is provided including authors, year of publication, references where this model has been cited, a short description, model assumption and model parameters is displayed (Fig. 5). The parameter values used in the relevant model can be obtained by clicking on the parameter (Fig. 6).

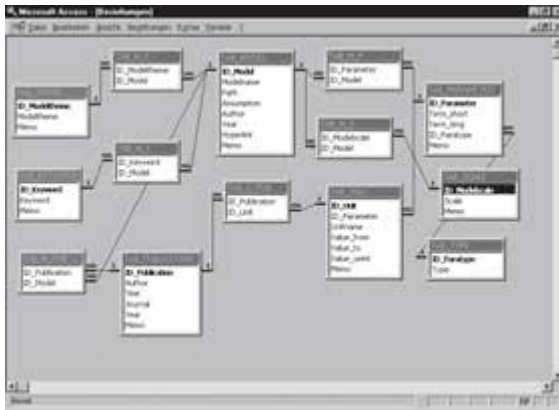

Fig. 1. Entity-Relationship Diagram

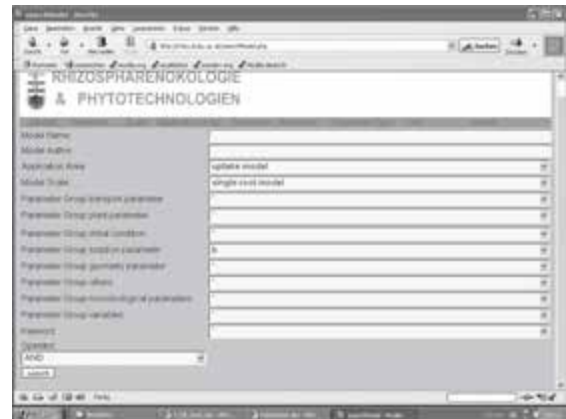

Fig. 4. Searching for rhizosphere models in the database

nr	Modellname	Autoren	Jahr
1	Cushman et al. model, 1988 - Application	Cushman B., Cushman S.	1988
2	1973 model - Application	Cushman B., Stange G.	1973
3	App model, 1984 - Application	Johns J., Stange L., Foster W.	1984
4	App model, 1984 - Application	Johns J., Stange L., Foster W.	1984
5	Paganini et al. model, 2000	Paganini L. C., Paganini C., Minetti S., Bernardi L. G., Tassi D. A.	2000
6	Van der Wal et al. model, 2007	Van der Wal A. C., Van Duin A. C. M., Pongers R.	2007

Fig. 2. First window of database after login



Fig. 5. Information about a specific model

nr	Scale	Model
1	Root system	
2	Scale of single root	
3	Single root model	
4	Single root model	

Fig. 3. List of Model Scales considered



Fig. 6. Example of information on parameter values: The buffer power used in an application of the Cushman model ranged from 93-1720.

ID	11_Bucher
Author	Bucher, Marcel Institute of Plant Sciences, Swiss Federal Institute of Technology Zürich Eschikon 33, CH-8315 Lindau, Switzerland marcel.bucher@ipw.biol.ethz.ch; +41 52 354 92 18
Parameter	Root morphology and activities
Soil type	Soil free system
Plant species	Numerous, e.g. potato, tomato, maize, rapeseed, poplar, etc.
System	aeroponic
Method	Aeroponic culture
Method description	<p>Aeroponics is a method of growing plants by delivering a nutrient mist to the roots. Three delivery systems are generally used:</p> <ul style="list-style-type: none"> - Hydro-atomizing spray jet (misting nozzle) - Disc atomizing system - Ultrasonic nebulizer <p>The nutrient mist is delivered into a tank containing growing roots. Fine nutrient solution droplets will form at the tip of root hairs via condensation and a nutrient film will cover the root tip. The aeroponic system usually allows optimal delivery of nutrients and aeration yielding rapid root growth with well developed root hairs. Root hairs extend far from the root surface and can be stripped off from roots for further experimental analysis.</p>
Do's, don'ts, potential limitations, untested possibilities	<p>We started our system with a disc atomizing system and then switched to spray jets. The disc's motor produces too much heat which leads to crystallization of nutrients on the motor and corrosive damage. Additionally, constant cooling is absolutely required. Roots can partially be excised, used for experiments and the plant produces new root material at almost no limits.</p> <p>We have used aeroponics to investigate root hair-specific gene expression and root hair-specific exudation.</p>
References	<p><i>Here, a transgenic approach was used to modify root hair-based secretion of a phytase protein. Root hair-driven secretion was investigated in plants which were cultivated on an aeroponics system to allow optimal development of the root hairs:</i></p> <p>Zimmermann, P.; Zardi, G.; Lehmann, M.; Zeder, C.; Amrhein, N.; Frossard, E.; Bucher, M. 2003. Engineering the root-soil interface via targeted expression of a synthetic phytase gene in trichoblasts. <i>Plant Biotechnol. J.</i> 1: 353-360.</p> <p><i>This work includes a detailed molecular characterization of a root hair-specific gene encoding an extensin-like protein:</i></p> <p>Bucher, M.; Brunner, S.; Zimmermann, P.; Zardi, G.; Amrhein, N.; Willmitzer, L.; Riesmeier, J.W. 2002. The expression of an extensin-like protein correlates with cellular tip growth in tomato. <i>Plant Physiol.</i> 128: 911-923.</p> <p><i>This work describes a molecular approach to clone root hair-specific genes:</i></p> <p>Bucher, M.; Schroeder, B.; Willmitzer, L.; Riesmeier, J.W. 1997. Two genes encoding extensin-like proteins are predominantly expressed in tomato root hair cells. <i>Plant Mol. Biol.</i> 35: 497-508.</p>

Additional
information

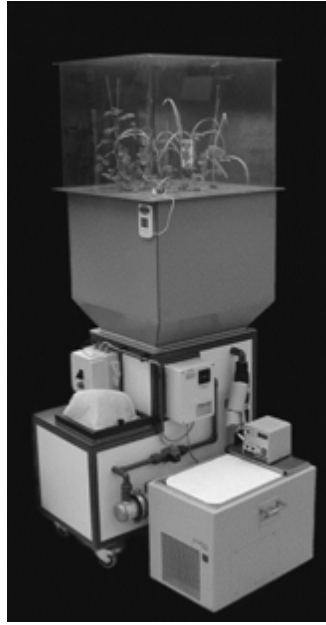

ID	11_Corgie
Author	Corgié, Stéphane; Joner, Erik; Leyval, Corinne* LIMOS (Laboratoire des Interactions Microorganismes-Minéraux-Matière Organique dans les Sols), UMR 7137 CNRS-UHP Nancy I, Faculté des Sciences, BP239, 54506 Vandoeuvre-les-Nancy Cedex, France corinne.leyval@limos.uhp-nancy.fr; ++33 3 83 68 42 82 *corresponding author
Parameter	PAH degradation and microbial community structure as a function of distance to roots
Soil type	PAH spiked sand
Plant species	Ryegrass (<i>Lolium perenne</i>)
System	Compartment device
Method	In vivo compartment devices
Method description	It consisted of PVC tubes forming a vertical root compartment (RC: 3.5 cm diam, 250 cm ³) and a horizontal rhizosphere compartment (RHC: 3.5 cm diam, 30 cm ³) separated from the RC by a 37 µm nylon mesh restricting root entry (Fig. 1). The RC was filled with a heat-sterilized (180°C, 2h) substrate composed of 60% Terragreen (Oil Dry, type IIIR, Lobbe), 30% sand (0.125-2 mm) and 10% vermiculite. Water and mineral nutrients were provided by a cotton wick connecting the root compartment to a 250 ml reservoir of nutrient solution. A one week old seedling of ryegrass (<i>Lolium perenne</i> L. cv. Barclay), pre-grown in vermiculite, was planted in each pot. Plants were grown for another 4 weeks prior to removing the cap filling the lateral aperture and inserting a sand-filled lateral compartment. The sand, previously spiked with phenanthrene (see detailed method in Corgié et al., 2003), was then filled in lateral compartments, inoculated with a microbial suspension (10 ⁵ cells g ⁻¹ sand) and watered with nutrient solution until 100% of its water holding capacity.
Do's, don'ts, potential limitations, untested possibilities	This compartment device can be used with soil instead of sand. Potential limitations are that fluxes between RC and RHC differ between planted and non planted devices, and this may affect the transfer of nutrients and the fate of pollutants.
References	<i>Description of the modified compartment device:</i> Corgié, S; Joner, E.J.; Leyval, C. 2003. Rhizospheric degradation of phenanthrene is a function of proximity to roots. Plant and Soil 257: 143-150. <i>These compartmented pots were modified from:</i> Joner, J.; Jakobsen, I. 1994. Contribution by two arbuscular mycorrhizal fungi to P uptake by cucumber (<i>Cucumis sativus</i> L) from P-32-labelled organic matter during mineralization in soil. Plant and Soil 163: 203-209.

Additional information

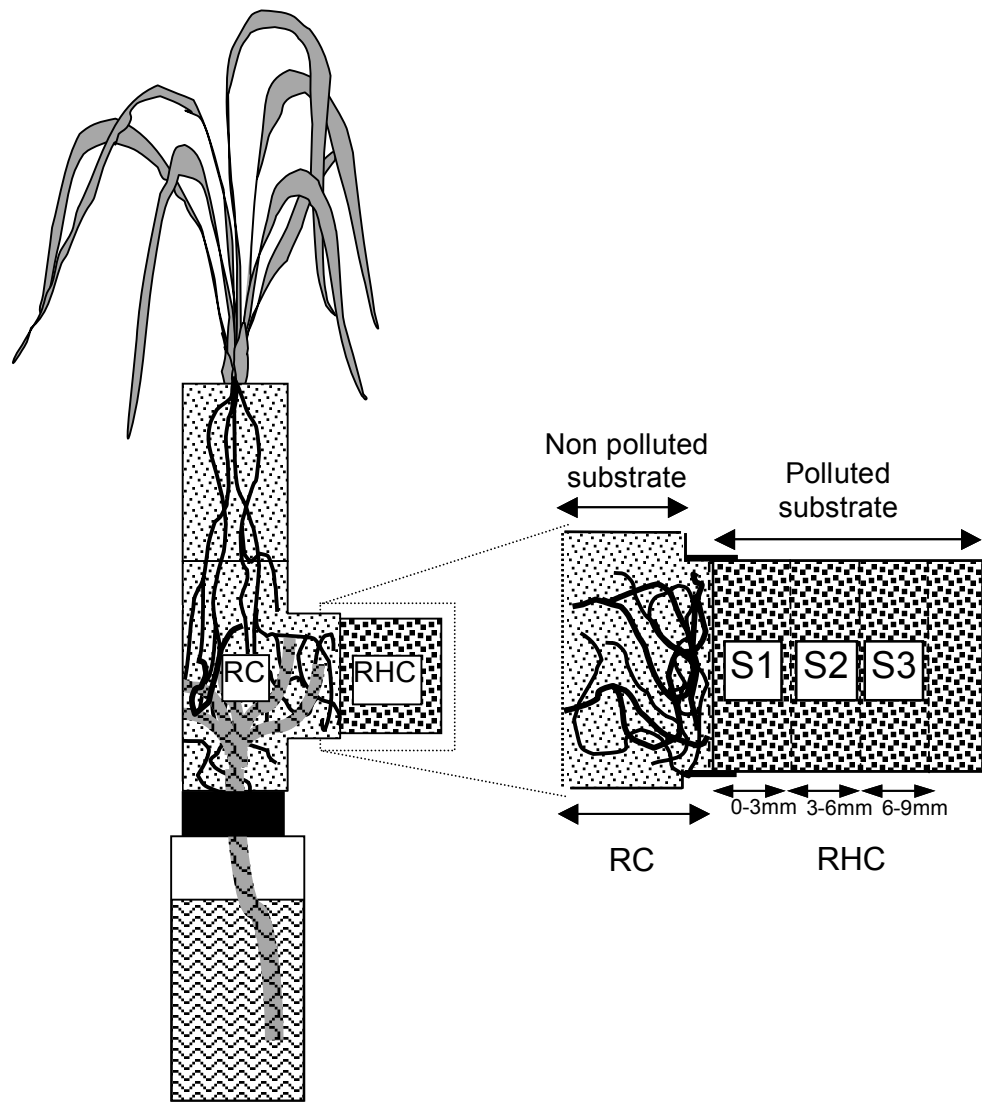
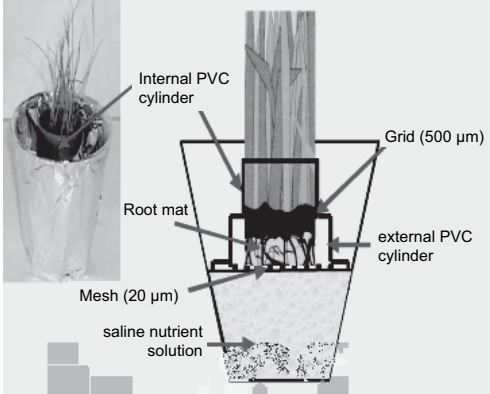
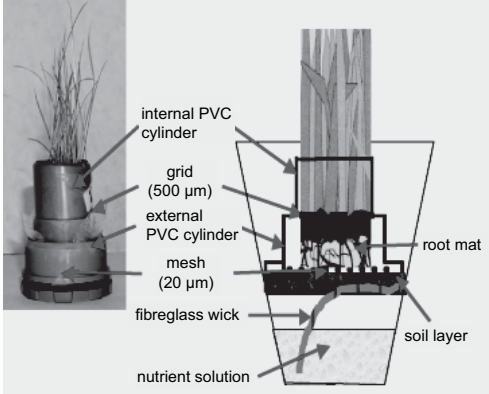

Fig. 1. Compartment device (from Corgié et al., 2003, with kind permission of Springer Science and Business Media)

ID	11_Eich_Greatorex
Author	Eich-Greatorex, Susanne Norwegian University of Life Sciences, Department of Plant and Environmental Sciences, PO Box 5003, N-1432 Aas, Norway susanne.eich@umb.no; ++47 64 96 55 72
Parameter	Gradients of chemical elements in soils
Soil type	Acid-washed sand
Plant species	Spruce (<i>Picea abies</i> [L.] Karst), Timothy (<i>Phleum pratense</i>)
System	Root observation chamber
Method	Root observation chamber with ion-exchange resins as element sources
Method description	A mixture of weak anion and cation exchange resins was filled into approximately 15 cm long, thin bags of nylon cloth, and loaded up with either a combination of nutrients or AlCl ₃ . A root observation chamber consisting of two Plexiglas plates held apart by a plastic tube, was filled with acid-washed sand. Two resin bags, one with nutrients and one with AlCl ₃ , were placed on either side of a plant seedling in the chamber. Irrigation occurred from ceramic cups at the edges. Gradients developing due to mass flow and diffusion were determined by sampling soil at different distances to the resin bags and at varying time intervals, and analysing for main nutrient cations and Al ³⁺ .
Do's, don'ts, potential limitations, untested possibilities	Chemical gradients remained stable over several weeks. It is therefore possible to study root growth reactions to different chemical gradients also of relatively slowly-growing plants (see method sheet 12_Eich_Greatorex). Ion-exchange resins may change their exchange characteristics depending on the type and amount of ions present in the soil solution and will therefore perform differently with different soils. In order to ensure that most of the Al would be present as toxic Al ³⁺ , a relatively low pH was necessary. Among others, glass fibre wicks were tested for irrigation, but increased the pH considerably.
References	James, B.R.; Bartlett, R.J.; Amadon, J.F. 1985. A root observation and sampling chamber (rhizotron) for pot studies. <i>Plant Soil</i> 85:291-293. <i>Information on different types of ion-exchange resins and their uses:</i> Skogley, E.O.; Dobermann, A. 1996. Synthetic ion-exchange resins: Soil and environmental studies. <i>J. Environ. Qual.</i> 25:13-24. Eich-Greatorex, S. 2003. Root distribution as influenced by the chemical conditions in the root-soil environment. Doctor scientiarum theses 2003:13. Agricultural University of Norway.

ID	11_EI_Azab
Author	EI-Azab, Kadria; Jauzein, Michel LIMOS ,UMR 7137 CNRS-UHP Faculté des Sciences et Techniques, Université Henri Poincaré Nancy 1, BP 239, 54506 Vandoeuvre -lès- Nancy cedex, France azab19@yahoo.com; michel.jauzein@limos.uhp-nancy.fr; ++33 3 83 68 42 83
Parameter	Bioavailability and phytotoxicity of metallic elements (Zn and Pb)
Soil type	Soil samples (applied to a Luvisol A horizon sample)
Plant species	adapted for Ryegrass (<i>Lolium perenne L.</i>)
System	Laboratory microcosm
Method	Soil contacting bioassay
Method description	<p>The experimental system (EI Azab and Jauzein, 2004; EI Azab, 2005) is built with two PVC cylinders derived from Nicoll ® PVC sewage water transport material (see the figure in additional information) : an internal PVC cylinder (inner diameter 35 mm) is pasted at the bottom side with a polyamide grid (500 µm), and inserted into an external PVC cylinder (inner diameter 44 mm), which is closed at the bottom side by a fine polyamide mesh (20 µm). Seeds placed inside the first internal cylinder develop roots in the space between the grid and the mesh (4.5 mm thickness) if contact with water is maintained. In addition, a special PVC stopper can be placed at the bottom of the system allowing the contact of the mesh with a cylinder of soil sample (7 mm thickness) and the connection with water through fiber glass wicks.</p> <p>The method is derived from Chaignon and Hinsinger (2003) and consists in two phases. The first is an hydroponic preculture. Seeds are placed in the internal cylinder and the system, without the stopper, is placed in a 80 ml nutritive solution container for two weeks in a growth chamber. The level of the solution is maintained in contact with seeds adding nutritive solution every day and the solution is changed after the first week. The second is a soil contacting culture. The stopper, filled with a contaminated soil sample (metallic elements like Zn or Pb), is placed at the bottom of the system for contacting with the mesh, close to the root mat. The system is than placed in a 60 ml nutritive solution container for two weeks in the same growth chamber. The solution is just changed after one week. Then shoots, roots and soil sample can be easily collected and separated for analysis of metallic element contents.</p>
Do's, don'ts, potential limitations, untested possibilities	The major advantage of this technique is that the thickness of the soil layer used, hence the distance from the roots to the soil compartment can be as little as a few millimetres. It can thereby be considered as rhizospheric soil and provide an easy access to fairly large amounts of rhizosphere soil in order to evaluate changes in rhizosphere metal speciation that are induced by roots, and easy separate the plants into shoots and roots biomass. This method has been used to study the bioavailability and phytotoxicity of Zn and Pb for Raygrass in various salinity conditions but seems to be available for other studies on the bioavailability and phytotoxicity of other soil contaminants for Raygrass or other plants.

<p>References</p>	<p>Effects of salinity on toxic element transfers in soils associated to agricultural wastewater reuse: mobility and bioavailability of zinc and lead for ryegrass in soils irrigated with saline water: El-Azab, K.; Jauzein, M. 2004. Eurosoil 2004 conference, paper presented at Symposium 14 "Desertification and Salinisation", September 04-12 2004 in Freiburg, Germany.</p> <p>Mobility, bioavailability and phytotoxicity of Pb and Zn in saline conditions: case of raygrass in a clay-loam and application to evaluating the risk of reusing the drainage water for irrigation in an arid zone: El-Azab, K. 2005. Thèse de Doctorat en Science des Sols, Université Henri Poincaré, Nancy, France</p> <p>A biotest for evaluating metal bioavailability to plant : application to copper-contaminated soils: Chaignon, V; Hinsinger, P. 2003. A biotest for evaluating copper bioavailability to plants in a contaminated soil. Journal of Environmental Quality 32: 824-833.</p>
<p>Additional information (see also colour plates on page 518)</p>	<div style="display: flex; justify-content: space-around;"> <div style="text-align: center;"> <p>Fig. 1. Preculture Stage</p>  </div> <div style="text-align: center;"> <p>Fig. 2. Soil-Contacting Stage</p>  </div> </div>

ID	11_Fitz
Author	Fitz, W.J.; Puschenreiter, M; Wenzel, W.W. Department of Forest and Soil Sciences, BOKU - University of Natural Resources and Applied Life Sciences, Vienna Gregor Mendel Straße 33, A-1180 Vienna, Austria walter.fitz@boku.ac.at; ++43 1 47654 31 20
Parameter	Rhizosphere gradients at high spatial resolution
Soil type	Any soil or solid substrates
Plant species	Any plant species, non-mycorrhizal
System	Lab microcosm
Method	Rhizobox system
Method description	Available tools to study rhizosphere characteristics at a sub-mm spatial resolution suffer from a number of shortfalls, including geometrically and physiologically ill-defined root layers containing soil or other growth medium. Here, the design allows roots to penetrate from the upper soil-root compartment through the slit into the root-only compartment. Root growth and distribution can be monitored through the acrylic window. Upon termination of the experiment, the rhizosphere compartment is removed and separation of sub-mm soil layers using either refrigerated microtome techniques or home-made slicing devices allowing sectioning of fresh rhizosphere. Thereafter, rhizosphere soil layers can be analysed by e.g. chemical extraction.
Do's, don'ts, potential limitations, untested possibilities	<ul style="list-style-type: none"> • Remove the rhizosphere soil compartment very carefully. As the root hairs can penetrate the membrane use a sharp knife to cut through root hairs between the membrane and the rhizosphere soil. Otherwise a soil layer would stick on the membrane. • The use of refrigerated microtomes can cause serious artifacts.
References	Wenzel, W.W.; Wieshammer, G.; Fitz, W.J.; Puschenreiter, M. 2001. Novel rhizobox design to assess rhizosphere characteristics at high spatial resolution. <i>Plant Soil</i> 237: 37-45. Fitz, W.J.; Wenzel, W.W.; Wieshammer, G.; Isteni, B. 2003. Microtome sectioning causes artifacts in rhizobox experiments. <i>Plant Soil</i> 256: 455-462.
Links	www.rhizo.at

Additional
information

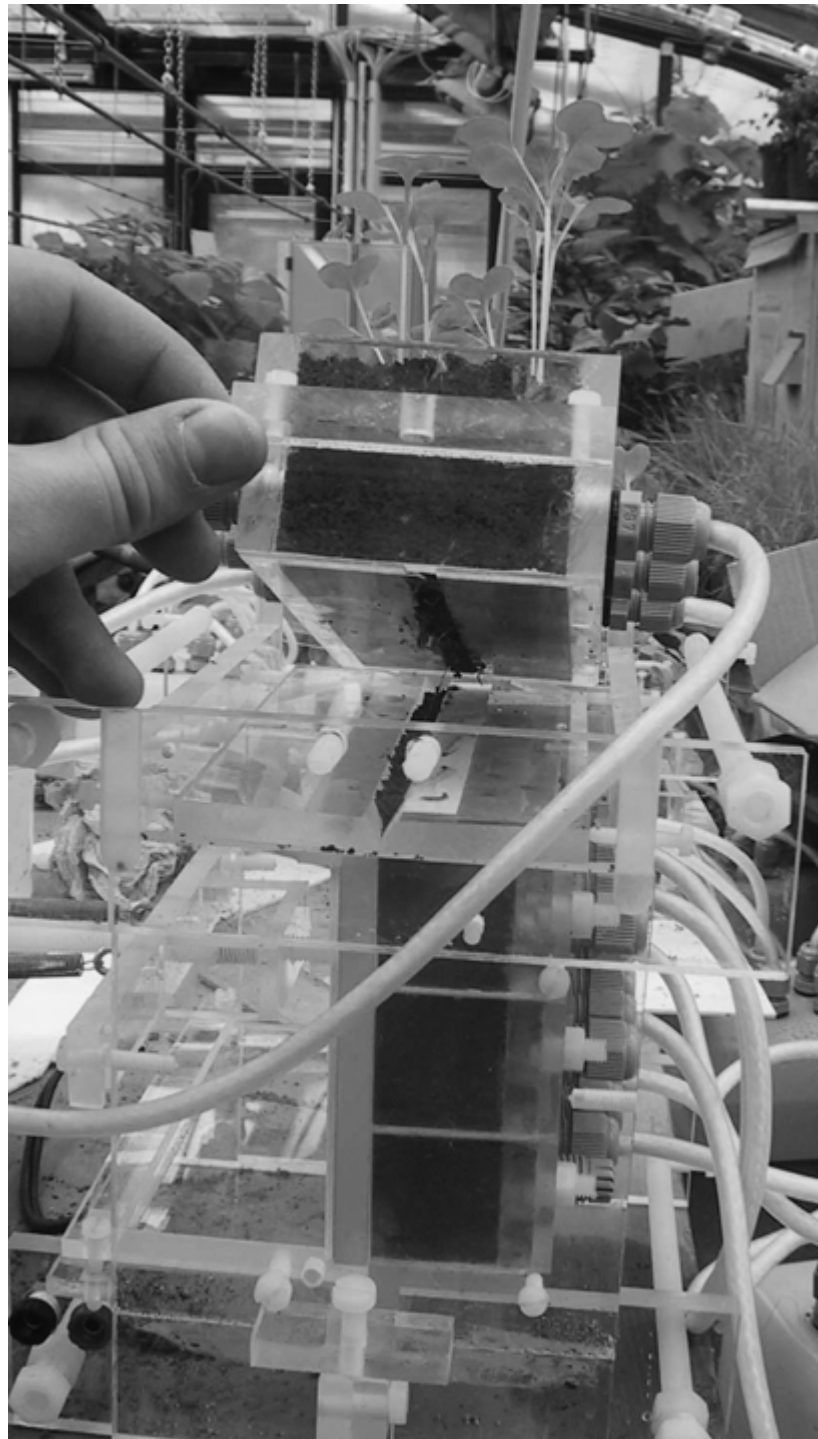
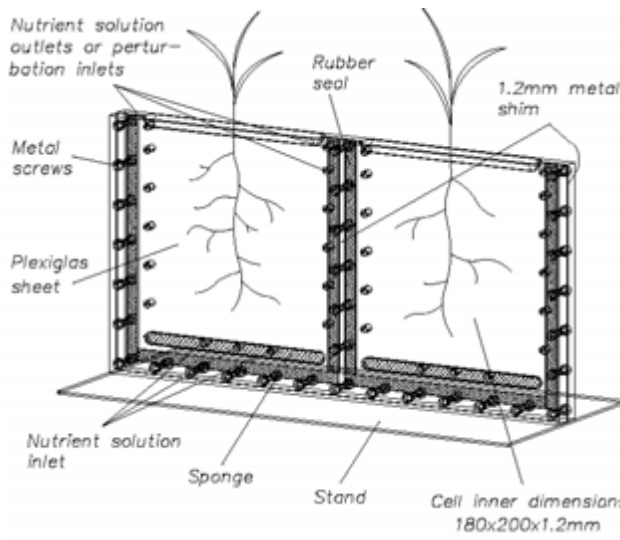
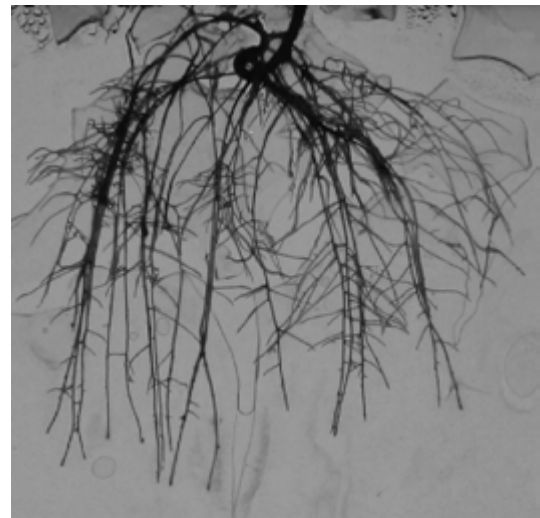

Figure 1 . Photograph of a rhizobox planted with canola (*Brassica napus* L.).The picture demonstrates how the upper compartment is put on the rhizobox after pre-growth. Continuous irrigation is achieved by glass fibre wicks.

ID	11_Futsaether
Author	Futsaether, Cecilia; Oxaal, Unni; Vollsnes, Ane V. Department of Mathematical Sciences and Technology, Norwegian University of Life Sciences, P.O. Box 5003, N-1432 Aas, Norway cecilia.futsaether@umb.no; unni.oxaal@umb.no; ane.vollsnes@umb.no; ++47 64965436
Parameter	Root length, growth rate and branching patterns at high spatial and temporal resolution
Soil type	Artificial media – glass beads, agar/gel.
Plant species	Lentil, clover, annual bluegrass, Norway spruce
System	Laboratory system
Method	2D rhizobox system
Method description	<p>The 2D rhizobox enables detailed observations of the dynamics of seedling root growth and development. The entire root system is visible throughout an experiment enabling images of high spatial resolution to be captured at any time. The need to remove and wash the root prior to observation is therefore eliminated. Thus, root development of an individual root system can be monitored at the macroscopic or microscopic level at intervals ranging from minutes to days.</p> <p>Roots are grown in a quasi two-dimensional environment comprising of a transparent medium sandwiched between two transparent Plexiglas sheets. The spacing between the Plexiglas sheets is usually chosen to be in the range 1 to 5 mm. A germinated seed is placed in a V-shaped groove at the top of the chamber. A light source (e.g. a white electroluminescent sheet (size A4)) is placed in back and a digital camera or microscope is placed in front of the rhizobox. Images of the silhouette of the root system growing in the rhizobox can then be captured. The light source is only turned on for the time required to capture an image (< 5s). The entire apparatus is encased in an opaque box such that the root is not exposed to light.</p> <p>Using a transparent medium instead of an opaque soil increases the visibility of the roots and improves image quality. The two-dimensionality of the rhizobox ensures that the root system grows approximately in a plane. Thus, a complicated three-dimensional problem is reduced to a two-dimensional problem that is simpler to observe, to analyse quantitatively and to model mathematically. Image analysis is also facilitated enabling root length, growth rate, branching angles, root diameter, root density distribution, number of root tips and number of lateral roots to be extracted from the images using standard imaging software.</p> <p><i>Growth medium – glass beads</i></p> <p>Use of a glass bead matrix instead of soil enables a particular root environment (i.e. particle size distribution, porosity) to be constructed. The spacing between the Plexiglas sheets is chosen to be slightly larger than the diameter of the glass beads. If the bead size distribution is homogeneous, the glass bead matrix will be approximately one bead layer thick. If a nonhomogeneous bead size distribution is used, the beads will be staggered and the width of the matrix will be more than one bead layer. Aerated nutrient solution is circulated through the rhizobox by pumping the solution into inlets at the bottom and removing the solution through outlets at the top of the box.</p>

	<p><i>Growth medium – agar</i> Warm agar (approximately 80-90°C) containing necessary nutrients is poured into the rhizobox to form a homogeneous growth medium. The agar is allowed to solidify (cool to room temp.) before a germinated seed is placed in the V-shaped groove. Add nutrient solution to the groove (e.g. using a syringe) as needed to prevent drying of the agar.</p>
<p>Do's, don'ts, potential limitations, untested possibilities</p>	<ul style="list-style-type: none"> • The method is suitable for short term (< 2 months), idealized studies of seedlings. • Insufficient watering of the agar during an experiment can lead to cracking of the agar. The top of the rhizobox should also be covered with parafilm to minimize evaporation and contamination from airborne microorganisms. • Insufficient washing (with alcohol, hypochlorite) of the rhizobox prior to an experiment can result in the formation of bacterial and fungal colonies in the agar.
<p>References</p>	<p>Futsaether, C.M.; Oxaal, U. 2002. A growth chamber for idealized studies of seedling root growth dynamics and structure. <i>Plant and Soil</i> 246: 221-230. and references therein</p>
<p>Additional information</p>	<p>Figure 1. The 2D rhizobox (from Futsaether and Oxaal, 2002, with kind permission of Springer Science and Business Media)</p>  <p>Figure 2. Image of 1 month old clover growing in agar</p> 

ID	11_Gahoonia
Author	Gahoonia, Tara Singh The Royal Veterinary and Agriculture University, Plant and Soil Sciences, Thorvalsensvej 40, 1871 Frederiksberg C, Denmark; tsg@kvl.dk; ++45 35283497
Parameter	Rhizosphere soil sampling
Soil type	Best for sandy loams
Plant species	Crop plants, best for plants with fine root systems
System	Microcosms with soil
Method	Microcosms (thin slicing or special procedure for root hair studies)
Method description	<p><i>Pregrowth:</i> In these methods, plants are pre-grown in vermiculite filled PVC tubes (length 10 cm, diameter 4.4 cm) closed at the bottom by nylon cloth impervious to roots. Two ceramic fibre wicks are placed along the inner sides of each tube to supply nutrient solution of defined composition. After about 10 days, the plants in tubes are transplanted into soil columns in PVC tubes (length 4 cm, diameter 5.6 cm). The soil columns are separated by a nylon screen of 53 µm (or 43 µm) into a 3 cm test soil below and 1-cm soil layer above the screen. The soil columns are maintained at defined soil moisture by placing them over small cup-shaped sand-baths each fitted with e.g. a 20 cm wick dipping into a reservoir of distilled water. The main supply of water and nutrients is met via the two ceramic fibre wicks. After transplantation, new root mats develop over the nylon screen. The geotropic nature of root growth implies that mostly the apical root parts are at the screen and root hairs penetrate into the soil column below the screen.</p> <p><i>Thin Slicing:</i> After desired experimental period (ca. 14 days), the soil columns are separated from the root mat and quickly frozen in liquid N₂ and sliced into 0.2 mm layers using freezing micro-tome. These soil samples can be analysed by usual analytical procedures.</p> <p><i>Sampling for root hair studies:</i> To study root hairs, six 1- mm holes are provided in the nylon screen. Some roots then penetrate and grow into the soil column below the screen. To get roots with intact root hairs, the soil columns are separated from the root mat and dispersed in water. Then the roots are carefully removed and treated with ultrasound (47K Hz) for about 5-10 minutes. This removes soil particles from the roots without damaging the root hairs. On these roots, root hair length, number and diameter are determined using image analysis.</p>
Do's, don'ts, potential limitations, untested possibilities	<ul style="list-style-type: none"> • We used these methods extensively to study variation in rhizosphere processes and root hairs of cereals and legume cultivars in relation to acquisition of soil phosphorus. • Method may not work well in extremely sandy and extremely clayey soils. It may not be useful for plant species with woody roots
References	<p>Gahoonia, T.S.; Nielsen, N.E. 1991. A method to study rhizosphere processes in thin soil layers of different proximity to roots. <i>Plant and Soil</i> 135: 143-146.</p> <p>Gahoonia, T.S.; Nielsen, N.E. 1997. Variation in root hairs of barley cultivars doubled soil phosphorus uptake. <i>Euphytica</i> 98: 177-182.</p>

ID	11_Goettlein
Author	Göttlein, A. Fachgebiet Waldernährung u. Wasserhaushalt Wissenschaftszentrum Weißenstephan, Am Hochanger 13 D-85354 Freising, Germany Goettlein@forst.tu-muenchen.de; ++49 8161 71 4749
Parameter	Root development and high resolution extraction of soil solution
Soil type	Acid forest soils
Plant species	Oak, beech, spruce
System	Field and laboratory
Method	Rhizotrones and root windows
Method description	<p><i>Rhizotrones in the laboratory</i> rhizotron with transparent front screen and back side with a grid of holes for the installation of micro suction cups, set up at an angle of about 30° to stimulate root growth at the transparent front plate; watering is done by porous polymer tubing or small ceramic cups set to a water potential of about -60hPa (Fig.1)</p> <p><i>Rhizotrones in the field</i> in a soil pit outcoming roots are „trapped“ in a rhizotron; root development can be observed at the transparent cover; watering is done by porous polymer tubing or small ceramic cups set to a water potential of about -60hPa; for the installation of micro suction cups, holes are drilled into the transparent cover at the desired positions (Fig.2)</p> <p><i>Root windows in the field</i> a stainless steel plate is driven into the soil at an angle of about 30°; then a soil pit is excavated, the steel plate removed and replaced by a transparent plexiglas plate, which is fixed to the soil by long nails and wedges; for the installation of micro suction cups, holes are drilled into the transparent cover at the desired positions (Fig.3)</p>
Do's, don'ts, potential limitations, untested possibilities	After filling the rhizotrones with dried soil, the system must be rewetted and equilibrated; a filtered batch water extract of the soil used to fill the rhizotrones proved to be a good basis for „designing“ a close to nature watering solution
References	<p><i>Description and application of the rhizotrones in the laboratory</i> Göttlein, A.; Heim, A.; Matzner, E. 1999. Mobilization of aluminium in the rhizosphere soil solution of growing tree roots in an acidic soil. Plant Soil 211: 41-49.</p> <p><i>Description and application of the rhizotrones and root windows in the field</i> Dieffenbach, A.; Matzner, E. 2000. In situ soil solution chemistry in the rhizosphere of mature Norway spruce (<i>Picea abies</i> [L.] Karst) trees. Plant Soil 222: 149-161.</p>

Fig.1

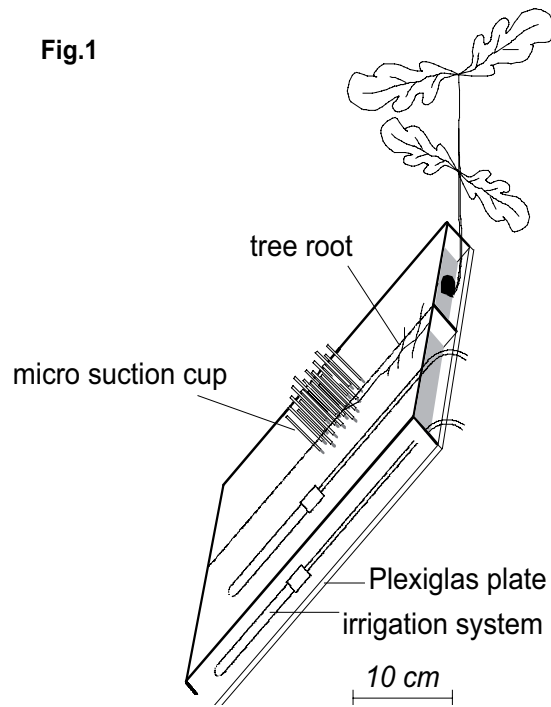

Fig.2

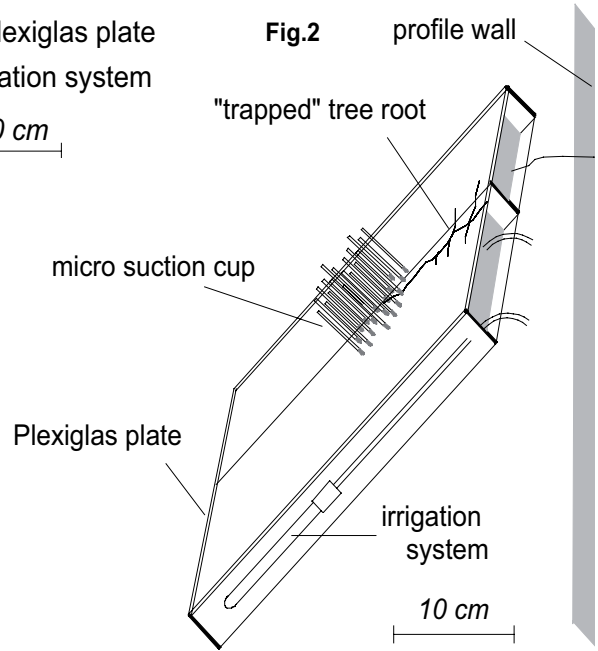
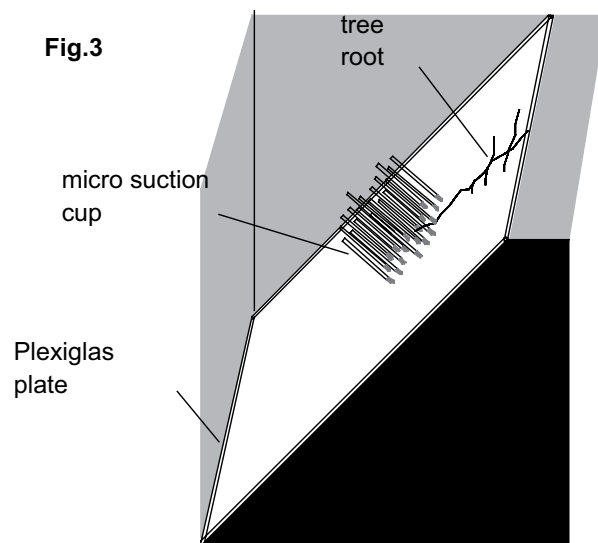

Fig.3



ID	11_Hacin
Author	Hacin, Janez University of Ljubljana, Biology centre, Večna pot 111, 1000 Ljubljana, Slovenia; Janez.Hacin@uni-lj.si
Parameter	Monitoring root growth and infection by rhizobia
Soil type	None
Plant species	Soybean, beans, other large seeded legumes
System	Laboratory, split-root growth system
Method	Split-root growth system using plastic growth pouches
Method description	<p><i>Growth assembly:</i> Two plastic growth pouches (mega international of minneapolis) are stapled together (Figure 1). Planting troughs are separated from the wick and the wick shortened by 1.5 cm by folding. A vertical cut (1,5 cm long) is made on the top edge through both bags (Fig.1-D) and a single trough (Fig.1-B) is passed through the cut so that one half of the through is in each bag. A strip (half of the second trough-Fig.1-A) is inserted into each bag to connect the trough (Fig.1-B) and the wick (Fig.1-C) and to direct lateral roots into the pouches. At planting, 25 ml of plant nutrient solution is added per pouch.</p> <p><i>Seedling preparation:</i> Seeds are surface-sterilized, rinsed several times with sterile H₂O, imbibed for several hours and sown hillum down in moist sterile vermiculite. Uniform seedlings (radicle length 1,5-2,5 cm) can be selected approximately 48 h after sowing, the tips of the radicles are cut off and the seedlings are planted into the centre of the trough (Fig.1-B).</p> <p><i>Growth assemblies</i> are arranged in a rack (custom made-Figure 2) and covered temporarily with transparent PE film to provide sufficient humidity for lateral root growth. When the roots reach the wick (4-5 days after planting-(Fig.1-C) the strip connectors (Fig.1-A) are removed and the roots can be selected and trimmed for uniformity.</p>
Do's, don'ts, potential limitations, untested possibilities	<p><i>Sterility:</i> Growth pouches purchased are sterile. Therefore, preparation of growth assemblies before planting is done in a laminar flow chamber. Hands and tools are sterilized by ethanol and flaming.</p> <p>Since roots are clearly visible the growth system is particularly suitable to monitor early infection events by rhizobia - e.g. nodule primordia, which can be observed in undisturbed pouches under a dissecting microscope. It has also been used in competition studies to monitor the speed of infection/nodulation by homologous strains of rhizobia. It may also be useful to study early stages of infection by other bacteria and fungi. The system is, however, limited to shorter growth periods (few weeks).</p>
References	Hacin, J.; Bohlool, B.B.; Singleton, P.W. 1997. Partitioning of ¹⁴ C-labelled photosynthate to developing nodules and roots of soybean (<i>Glycine max</i>). New Phytol. 137: 257-265.

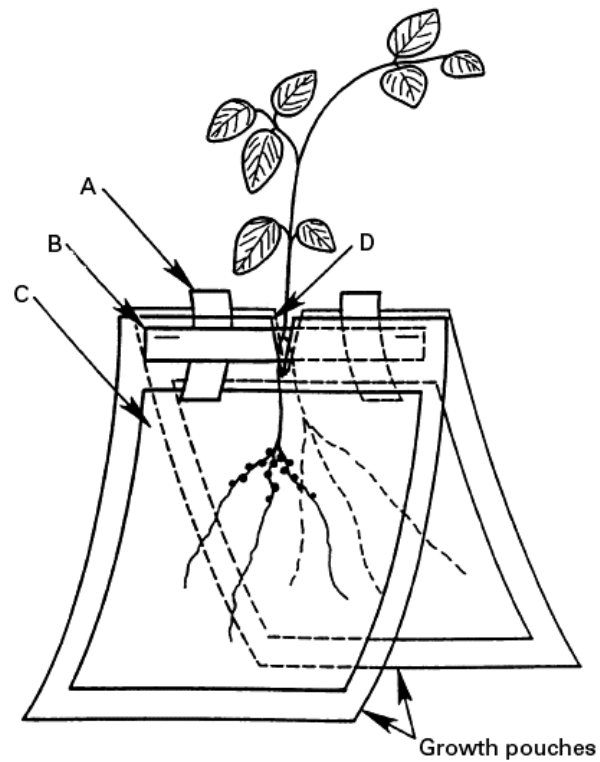

Figure 1. Diagram of the split-root growth system consisting of two growth pouches stapled together: A, strip connecting B, the planting trough with C, the main wick. D, vertical cut through both pouches to allow the planting through to pass from one pouch into the other (from Hacin et al., 1997; reproduced with permission of the *New Phytologist* Trust).



Figure 2. Split-root growth assemblies arranged in home made racks - from wood and Al wire (see also colour plate on p. 519)

ID	11_Heim_a
Author	Heim, Alexander ¹⁾ ; Luster, Jörg ²⁾ ¹⁾ University of Zürich, Department of Geography, Physical Geography, Winterthurerstr. 190, CH-8057 Zürich, Switzerland +41 44 63 55 183; alexheim@geo.unizh.ch ²⁾ Swiss Federal Institute for Forest, Snow, and Landscape Research WSL, CH-8903 Birmensdorf, Switzerland ++41 44 739 22 95; joerg.luster@wsl.ch
Parameter	Not specified
Plant species	Norway spruce (<i>Picea abies</i>)
System	Hydroponic systems, growth chamber
Method	Hydroponic treatment at constant pH
Method description	<i>Three year old trees</i> are treated individually in Erlenmeyer flasks that accommodate the root system. <i>Three month old seedlings</i> are supported by a specially designed „comb“ fixed inside a rectangular glass container. The system allows simultaneous treatment of 100 seedlings at a time. <i>pH-stat conditions</i> Treatment solutions are renewed every second or third day. In between, pH is monitored with a pH electrode, and the pH is automatically adjusted by addition of acid if necessary.
Do's, don'ts, potential limitations, untested possibilities	<i>Length of treatments:</i> The two systems have been used only for short-term treatments up to one week, not for plant growth. Be aware of a treatment shock after installing the system: Exudation is much higher immediately after the start of the experiments than a few days later. <i>Aeration:</i> The solutions are continuously bubbled with sterile filtered air, however, the effect of aeration has not been tested yet. <i>Sterility:</i> For older plants that have been raised in soil, sterile conditions are not feasible. Seedlings can be raised (e.g. in perlite) and transferred to the comb support under sterile conditions. At any rate, sterile filtration of the treatment solutions prior to the experiment is recommended. <i>Tree species</i> other than Norway spruce have not been tested yet.
References	<i>System for 3-year old trees:</i> Heim, A.; Luster, J.; Brunner, I.; Frey, B.; Frossard, E. 1999. Effects of aluminium treatment on Norway spruce roots: Aluminium binding forms, element distribution, and release of organic substances. Plant Soil 216: 103-116. <i>System for 3-month old seedlings:</i> Heim, A.; Brunner, I.; Frey, B.; Frossard, E.; Luster, J. 2001. Root exudation, organic acids, and element distribution in roots of Norway spruce seedlings treated with aluminium in hydroponics. J. Plant Nutr. Soil Sci. 164: 519-526.

ID	11_Heim_b
Author	Heim, Alexander ¹⁾ ; Luster, Jörg ²⁾ ¹⁾ University of Zürich, Department of Geography, Physical Geography, Winterthurerstr. 190, CH-8057 Zürich, Switzerland ++41 44 63 55 183; alexheim@geo.unizh.ch ²⁾ Swiss Federal Institute for Forest, Snow, and Landscape Research WSL, CH-8903 Birmensdorf, Switzerland; ++41 44 739 22 95; joerg.luster@wsl.ch
Parameter	Not specified
Plant species	Norway spruce (<i>Picea abies</i>)
System	Solid substrate, growth chamber
Method	Treatment in perlite
Method description	<i>Cleaning of the substrate:</i> Perlite is thoroughly washed with sulfuric acid and distilled water before use, and then dried. <i>Treatments:</i> Cleaned and dried perlite is filled into 800 ml polypropylene beakers. One or 2 beakers are placed in a “sunbag” (Sigma), made of light-transparent material and equipped with an air-filter to allow air circulation without contamination. About 80 surface sterilised seeds are sown into one beaker. A single addition of treatment solution - the nutrient composition of which mimics conditions in acid forest soils - at the beginning can provide enough nutrients for 5 months growth, after which a biomass of 500-900 mg dry wt per beaker can be obtained.
Do's, don'ts, potential limitations, untested possibilities	<i>Sterility:</i> Upon autoclaving, perlite releases high amounts of Na. Alternatively, the entire system without treatment solution may be heated for several days at 105 °C, but a sterility check should be performed. Treatment solutions should be sterilised by 0.2 um filtration rather than by autoclaving, especially if Al is added. <i>pH changes:</i> Buffer reactions between treatment solution and perlite increase the pH of the pore solution. A pH <5 cannot be held in perlite. <i>Pore water:</i> At the end of a treatment, perlite can be crushed with a mortar and pestle, which releases the pore water. After centrifugation of the suspension, exudates can be measured in the pore water. Their concentrations are in the low micromolar range. <i>Production of plant material:</i> The system can also be used to produce plant material for other experiments. Plants can be removed relatively easily from the growth substrate if no mycorrhizal inocula are added.
References	<i>Growth of Norway spruce seedlings in perlite with/without mycorrhizal inoculation and with/without Al addition; organic acids in perlite pore water:</i> Heim, A.; Brunner, I.; Frossard, E.; Luster, J. 2003. Soil Sci. Soc. Am. J. 67: 895-898. <i>Use of perlite as pregrowth substrate for hydroponic experiments:</i> Heim, A.; Brunner, I.; Frey, B.; Frossard, E.; Luster, J. 2001. J. Plant Nutr. Soil Sci. 164: 519-526.
Links	<i>Sunbags:</i> www.sigmaaldrich.com/suite7/Area_of_Interest/Life_Science/Plant_Biotechnology/Tissue_Culture_Protocols/Sunbag_Vessels.html <i>Information on perlite:</i> www.perlite.org

ID	11_Hinsinger_a
Author	Hinsinger, Philippe INRA-ENSA.M - UMR Rhizosphère & Symbiose Place Viala, F-34060 Montpellier cedex 1 (France) philippe.hinsinger@ensam.inra.fr ; ++33 4 99 61 22 49
Parameter	Any soil or soil solution parameter (except physical properties) + simplified access to soil-free roots for chemical analysis
Soil type	Any soil or solid substrates
Plant species	Any possible species, except those with strong tap or woody roots
System	Lab microcosm
Method	Mini-rhizobox system with soil or solid substrate
Method description	The growth technique is based on a two step procedure : (i) 'preculture period' – plants are grown from seeds on the surface of a polyamide net in hydroponics until a dense, planar mat of roots is obtained on the surface of the net, (ii) 'test culture period' – plants are then transferred on top of a soil or any other solid substrate to be tested (e.g. pure minerals). Two options are possible: (i) the soil is used as a thin layer (1-3 mm) so that the whole of it can be considered as rhizosphere material within a few hours or days of growth (only this option is described in details here) or (ii) the soil is filling a cylinder which, upon completion of the growth experiment, can be easily cut with a razor blade parallel to the root mat, in order to measure rhizosphere gradients. Soil solution samplers or electrodes can possibly be inserted to monitor some soil parameters. The soil is sitting on a filter paper wick connected to a nutrient solution reservoir, to supply water and nutrients.
Do's, don'ts, potential limitations, untested possibilities	As any other root mat technique, it provides a simplified geometry of the rhizosphere and does not allow access to spatial variability of functioning along root axes. Another limitation is that the soil being directly connected to a nutrient solution (or water) reservoir, its water content is above field capacity and close to saturation. A major advantage of the technique is that the growth device is simple, cheap and small and that rhizosphere soil can be easily collected after a few hours or days of contact with pre-grown plants. Indeed the whole thin layer of soil which amount about only 2 to 5 grams can be considered as rhizosphere as the distance from root surface is ranging from 1 to 3 mm (adjusted to a given thickness according to the experimental requirements). This is also interesting when using radioisotopes as the amount of contaminated soil can be minimized. Compared with soil-grown plants in conventional pot experiments, this method provides easy acces to roots that are nearly free of adhering soil particles, as needed when studying soil-root transfer of trace elements. The soil can be replaced by mixtures of minerals e.g. quartz or alumina sand mixed with Ca-phosphates or K-silicates or Fe-oxides as already tested (e.g. Hinsinger and Gilkes, 1997).
References	Chaignon, V; Hinsinger, P. 2003. A biotest for evaluating copper bioavailability to plants in a contaminated soil. J. Environ. Qual. 32: 824-833. Guivarch, A.; Hinsinger, P.; Staunton, S. 1999. Root uptake and distribution of radiocaesium from contaminated soils and the enhancement of Cs adsorption in the rhizosphere. Plant and Soil 211: 131-138. Hinsinger, P.; Gilkes, R.J. 1997. Dissolution of phosphate rock in the rhizosphere of five plant species grown in an acid, P-fixing mineral substrate.

Geoderma 75: 231-249.

<http://www.montpellier.inra.fr/RetS/ressources.htm> (see culture in rhizotron)

The materials are either PVC pipes (used for plumbing) or perspex cylinders. Different diameters can be used, according to the size of plants and amount of soil to be used. Fig. 1 shows the upper part which is made of two pipes: the inner pipe has got a grid glued at the bottom through which roots but not seeds can get through; the outer pipe with the polyamide net (mesh size can vary according to smaller diameter of rootlets) at the bottom (attached with rubber band (not shown)). Fig. 2 shows the bottom part of the growth device, which thickness can vary to accommodate either a thin layer of soil (1-3 mm) or a cylinder of soil of greater height (> 10 mm) if aiming at studying rhizosphere gradients.

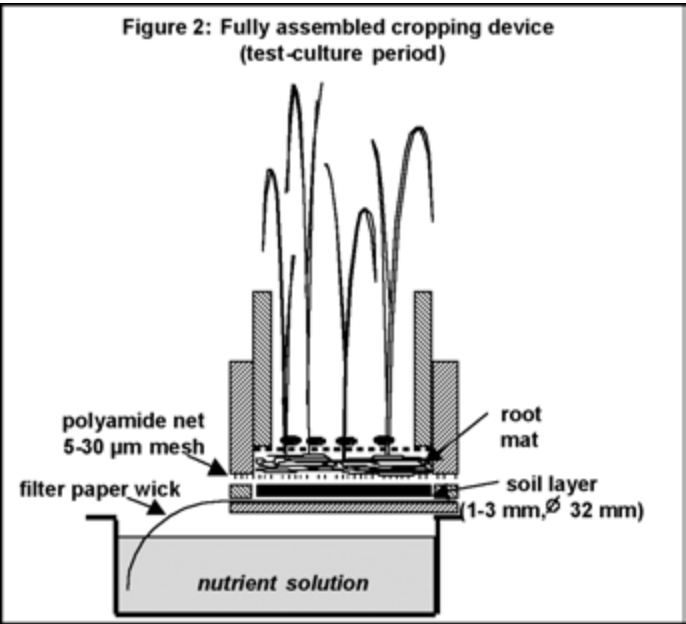
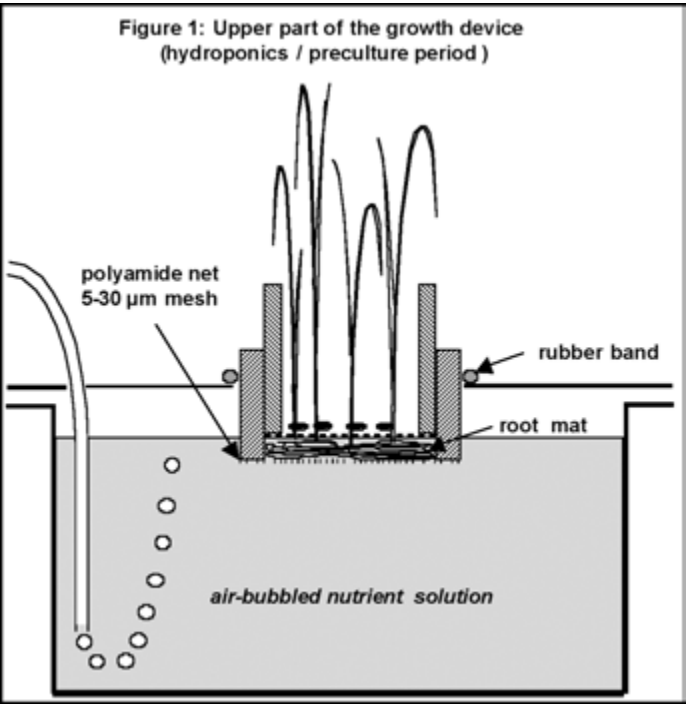

ID	11_Hinsinger_b
Author	Hinsinger, Philippe INRA-ENSA.M - UMR Rhizosphère & Symbiose Place Viala, F-34060 Montpellier cedex 1 (France) philippe.hinsinger@ensam.inra.fr ; +33 4 99 61 22 49
Parameter	Any soil or soil solution parameter (except physical properties) + simplified access to soil-free roots for chemical analysis
Soil type	Any soil or solid substrates suspended in a gel
Plant species	Any possible species, except those with strong tap or woody roots
System	Lab microcosm
Method	Mini-rhizobox system / gel
Method description	The growth technique is based on a two step procedure : (i) 'preculture period' – plants are grown from seeds on the surface of a polyamide net in hydroponics until a dense, planar mat of roots is obtained on the surface of the net, (ii) 'test culture period' – plants are then transferred on top of a gel containing a suspension of soil or any other solid substrate to be tested (e.g. pure minerals). Two options are possible: (i) the gel is made of a thin layer (1-3 mm) so that the whole of it can be considered as rhizosphere material within a few hours or days of growth or (ii) the gel is made of a cylinder which, upon completion of the growth experiment, can be easily cut with a razor blade parallel to the root mat, in order to measure rhizosphere gradients. In both cases, liquid phase of the gel samples can be easily obtained by freezing-thawing (to measure pH, concentrations, etc...). The net which separates the root mat from the gel also functions as a wick to supply water and nutrients from a connected reservoir, so that the gel does not dry out and shrink.
Do's, don'ts, potential limitations, untested possibilities	As any other root mat technique, it provides a simplified geometry of the rhizosphere and does not allow access to spatial variability of functioning along root axes. Another limitation is the potential risk that the gel dries out if the water demand of the plant is higher than the ability of the polyamide net to supply water. The use of a gel is interesting for diluting the soil or solid substrate in order to evidence changes which would not be otherwise detected. This is also interesting when using radioisotopes as the amount of contaminated substrate can be minimized. In addition, the gel prevents any adhesion of solid particles onto roots, which is a strong limitation for analysing roots of soil-grown plants, especially when studying soil-root transfer of trace elements. The gel can be replaced by e.g. quartz or alumina sand to dilute the solid substrate, if preferred. Another option is to work with undiluted soil (see Mini-rhizobox / soil method). A major advantage of the technique is that the growth device is simple, cheap and small and that rhizosphere material can be easily collected after a few hours or days of contact with pre-grown plants.
References	Hinsinger, P.; Jaillard, B.; Dufey, J.E. 1992. Rapid weathering of a trioctahedral mica by the roots of ryegrass. <i>Soil Sci. Soc. Am. J.</i> 56: 977-982. Kruyts, N.; Thiry, Y.; Delvaux, B. 2000. Respective horizon contributions to cesium-137 soil to plant transfer : a rhizospheric experimental approach. <i>J. Environ. Qual.</i> 29: 1180-1185. Niebes, J.F.; Hinsinger, P.; Jaillard, B.; Dufey, J.E. 1993. Release of nonexchangeable potassium from different size fractions of two highly K-fertilized soils in the rhizosphere of rape (<i>Brassica napus</i> cv Drakkar). <i>Plant Soil</i> 155/156: 403-406.

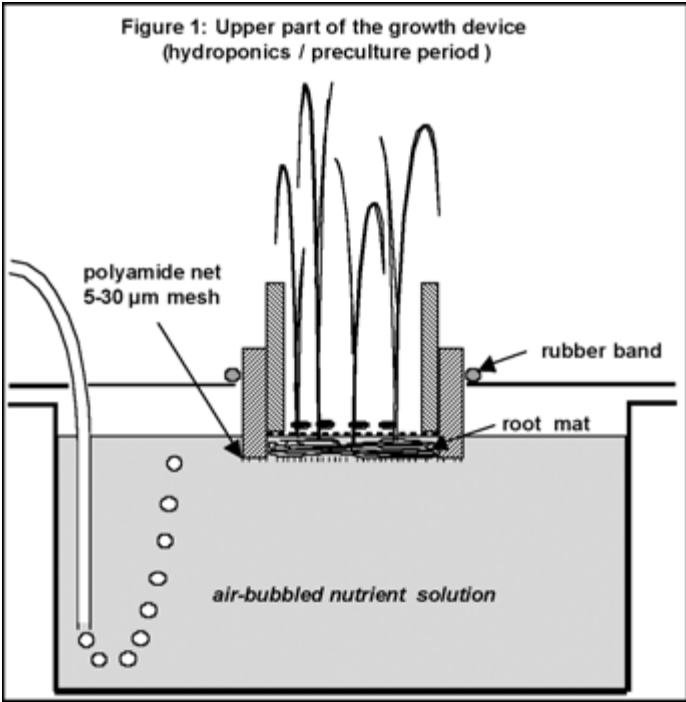
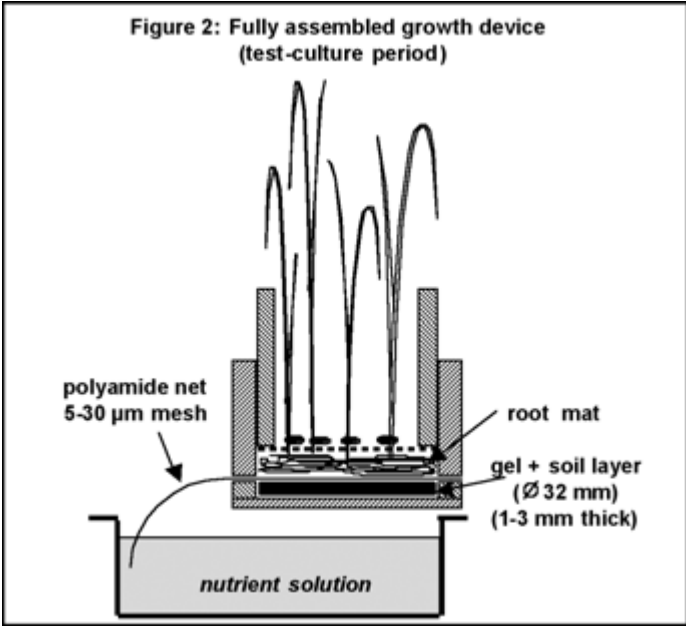
Links	http://www.montpellier.inra.fr/RetS/ressources.htm (see culture in rhizotron)
Additional information	<p>The materials are either PVC pipes (used for plumbing) or perspex cylinders. Different diameters can be used, according to the size of plants and amount of gel to be used. Fig. 1 shows the upper part which is made of two pipes: the inner pipe has got a grid glued at the bottom through which roots but not seeds can get through; the outer pipe with the polyamide net (mesh size can vary according to smaller diameter of rootlets) at the bottom (attached with rubber band (not shown)). Fig. 2 shows the bottom part of the growth device, which thickness can vary to accommodate either a thin layer of gel (1-3 mm) or a cylinder of gel of greater height (> 10 mm) if aiming at studying rhizosphere gradients.</p> <div style="text-align: center;">  <p>Figure 1: Upper part of the growth device (hydroponics / preculture period)</p> </div> <div style="text-align: center;">  <p>Figure 2: Fully assembled growth device (test-culture period)</p> </div>

ID	11_Le_Bayon
Author	Le Bayon, Renée-Claire ¹⁾ ; Jansa, Jan ²⁾ ; Frossard, Emmanuel ²⁾ ¹⁾ University of Neuchâtel, Botanical Institute, Plant and Soil Ecology Emile Argand Street, 11, CH-2007 Neuchâtel, Switzerland claire.lebayon@unine.ch; ++ 41 32 718 23 65 ²⁾ Institut für Pflanzenwissenschaften, Versuchsstation Eschikon, Eschikon 33, CH-8315 Lindau, Switzerland jan.jansa@ipw.agrl.ethz.ch ; ++ 41 52 354 92 16; emmanuel.frossard@ipw.agrl.ethz.ch; ++ 41 52 354 91 40
Parameter	Soil nutrient dynamics at different distances from plant roots; plant and fauna interactions.
Soil type	All types
Plant species	All types
System	Microcosm
Method	Microcosm
Method description	<p>Design of a microcosm may be highly variable according to the experiment conducted. The most simplified model is a single PVC or Plexiglas tube. Its diameter and length can be varied.</p> <p><i>Experimental design</i></p> <p>To allow spatial studies on soil in relation to the distance from plant root system, a microcosm based on the Starpot system (Jansa et al., 2003, see the scheme below) could be used. It is based on compartmentation principle used since a long time in mycorrhiza research (Schüepp et al., 1987; Jakobsen et al., 1992; Joner and Jakobsen, 1994). It consists of a central tube (15 cm dia and 35 cm height) and four small perpendicular ones ("side arms", 4 cm dia and 20 cm long; Fig. 1). Wall thickness of the central tube must be at least 5 mm to provide sufficient mechanical support for the side arms. The microcosm (central tube and side arms) is filled with 2 mm-sieved and remoistened soil at a final bulk density around 1.3 g cm⁻³. Soil is then moistened to its water holding capacity. Microcosms are then placed in a growth chamber to control both temperature and humidity. Seeds are sown into the central tube. Nutrient solution and water are supplied according to plant needs and research objectives.</p> <p><i>Flexibility and improvement of the design</i></p> <p>In plant and rhizosphere research, the root passage to the side arms could be avoided by inserting a 25µm-nylon mesh between the side arm and the central tube. This system allows separation of bulk soil and the rhizosphere soil (Le Bayon et al., unpublished). To collect percolation water, a funnel could be attached to the bottom of the microcosms. Soil fauna may also be introduced in microcosms, e.g. earthworms to study their burrowing network (Jégou et al., 2000) and/or their interactions with soil microbes and plant roots (Fraser et al., 2003). Complex designs hermetically closed are usually used to measure respiratory exchanges of worms and/or microorganisms (Binet and Tréhen, 1992). In this case, a trap of NaOH catches the CO₂.</p>
Do's, don'ts, potential	<ul style="list-style-type: none"> • Microcosms lead to an experimental design closer to natural conditions than small pots or rhizoboxes usually used in rhizosphere research.

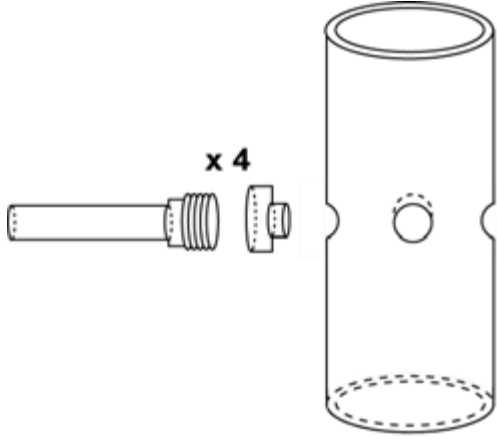
<p>limitations, untested possibilities</p>	<p>However, it remains enclosed and offers sometimes too little space for plants or soil fauna. The next step is probably larger designs as mesocosms both in the laboratory and in the field.</p> <ul style="list-style-type: none"> • Another problem is the watering of the side arms. We used in our case a baked clay system (Oil Dry Chem-Sorb WR24/18, Brenntag, Vitrolles, France; also provided by Maag Technics, Dübendorf, ZH) to help infiltration of water from the central tube. Zones with excluded roots longer than a few centimeters may not be realistic in comparison with field conditions where inter-root distances are usually a few mm only.
<p>References</p>	<p>Binet, F.; Tréhen, P. 1992. Experimental microcosm study of the role of <i>lumbricus-terrestris</i> (oligochaeta, lumbricidae) on nitrogen dynamics in cultivated soils. <i>Soil Biol. Biochem</i> 24: 1501-1506.</p> <p>Fraser, P.M.; Beare, M.H.; Butler, R.C.; Harrison-Kirk, T.; Piercy, J.E. 2003. Interactions between earthworms (<i>Aporrectodea caliginosa</i>), plants and crop residues for restoring properties of a degraded arable soil. <i>Pedobiologia</i> 47: 870-876</p> <p>Jakobsen, I.; Abbott, L.K.; Robson, A.D. 1992. External hyphae of vesicular-arbuscular mycorrhizal fungi associated with <i>trifolium-subterraneum</i> L. 1. Spread of hyphae and phosphorus inflow into roots. <i>New Phytologist</i> 120: 371-380.</p> <p>Jansa, J.; Mozafar, A.; Frossard, E. 2003. Long-distance transport of P and Zn through the hyphae of an arbuscular mycorrhizal fungus in symbiosis with maize. <i>Agronomie</i> 23: 481-488.</p> <p>Jégou, D.; Cluzeau, D.; Hallaire, V. 2000. Burrowing activity of the earthworms <i>Lumbricus Terrestris</i> and <i>Aporrectodea giardi</i> and consequences on C transfers in soil. <i>Eur. J. Soil Biol.</i> 36: 27-34</p> <p>Joner, E.J.; Jakobsen, I. 1994. Contribution by 2 arbuscular mycorrhizal fungi to P-uptake by cucumber (<i>Cucumis-sativus</i> L.) from P-32 labeled organic matter during mineralization in soil. <i>Plant and Soil</i> 163, 203-209.</p> <p>Schüepp, H.; Dehn, B.; Sticher, H. 1987. VA Mycorrhiza and heavy-metal stress. <i>Angewandte Botanik</i> 61, 85-96.</p>
<p>Additional information</p>	 <p>Figure 1. Scheme of the microcosm.</p>

ID	11_Neumann
Author	Neumann, Günter Institute of Plant Nutrition (330) Hohenheim University, 70593 Stuttgart e-mail: gd.neumann@t-online.de, phone: +49 711 459 4273
Parameter	Plant culture systems
Soil type	All soils
Plant species	All species
System	Pot experiments, soil, solid substrates
Method	Construction and setup of rhizoboxes
Method description	<p><i>Construction:</i> PVC plates are an ideal inert material with flexible use for construction of rhizoboxes of any dimension (Fig. 1a-e), starting with small-sized boxes (1.0 x 10.0 x 25.0 cm; approx. 0.3 kg soil), designed for small plants and seedlings during early growth (Fig. 1e), up to long-term culture systems with 80-100 kg soil e.g. for trees. Holes on the backside of the box (Fig. 1f-I), covered with a moist viscose-fleece (Fig. 1f-II) are used for irrigation and homogenous distribution of water over the whole soil profile. A transparent plastic foil (Fig. 1f-III) covers the soil before closing the rhizobox with a transparent Perspex lid (Fig. 1f-III) and prevents sticking of roots and soil to the lid when the box is opened again. Screws (Fig. 1a-c), adhesive tapes (Fig. 1d), clamps (Fig. 1f), or rubber rings can be employed to ensure tight closure of the box. During plant culture, the boxes should be fixed in an angle of 35-45° with the Perspex lid to the bottom side (Fig. 1g), to induce positive geotropic root growth preferentially along the root observation window. For light exclusion, the transparent lid is covered with a black plastic foil. A special type of compartmentalized rhizoboxes is used for studies with root compartments and removable rhizosphere-soil compartments, separated by a nylon gaze or membranes with different mesh size, which enable selective penetration of root exudates, soil solution or mycorrhizal hyphae but exclude direct root contact to the rhizosphere soil compartments (Fig. 2).</p> <p><i>Setup:</i> Use soil sieved to a mesh size of 2 mm, mix thoroughly with fertilizer solutions and adjust to a soil moisture level of 8% (w/w). Cover the holes on the backside of the rhizobox with the moist viscose fleece and fill the box to the desired bulk density by compaction of the soil with the Perspex lid. Transfer pre-germinated seedlings by softly pressing the roots into the flat soil surface of the observation window, cover with the transparent plastic foil and finally close the box with the Perspex lid. Adjust final soil moisture by watering through the holes on the back side and record start weight.</p>
Do's, don'ts, potential limitations, untested possibilities	<p><i>Applications:</i> Measurements of root growth (Fig. 3a,b), collection of root exudates (Fig. 3c) root-induced chemical changes (Fig. 3c and f-k). For further description of applications and references see method sheets 31_Neumann_b, e to j</p>

Additional information (see also colour plates on p. 520)

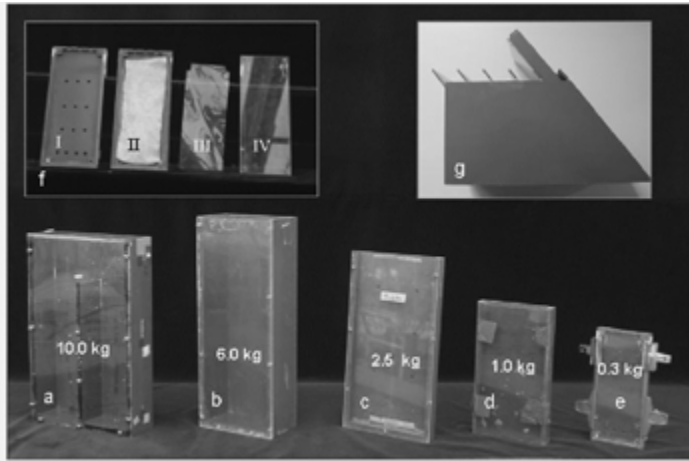

Fig. 1: Different sizes (a-e) and parts (f) of PVC-rhizoboxes consisting of a corpus with irrigation holes (f-I); a viscose fleece for moisture distribution (f-II); transparent plastic foil for soil-covering (f-III) and a Perspex front lid (f-IV) mounted with screws (a-c), adhesive tape (d) or clamps (e). Rhizobox holder for fixing five rhizoboxes during the culture period (g).

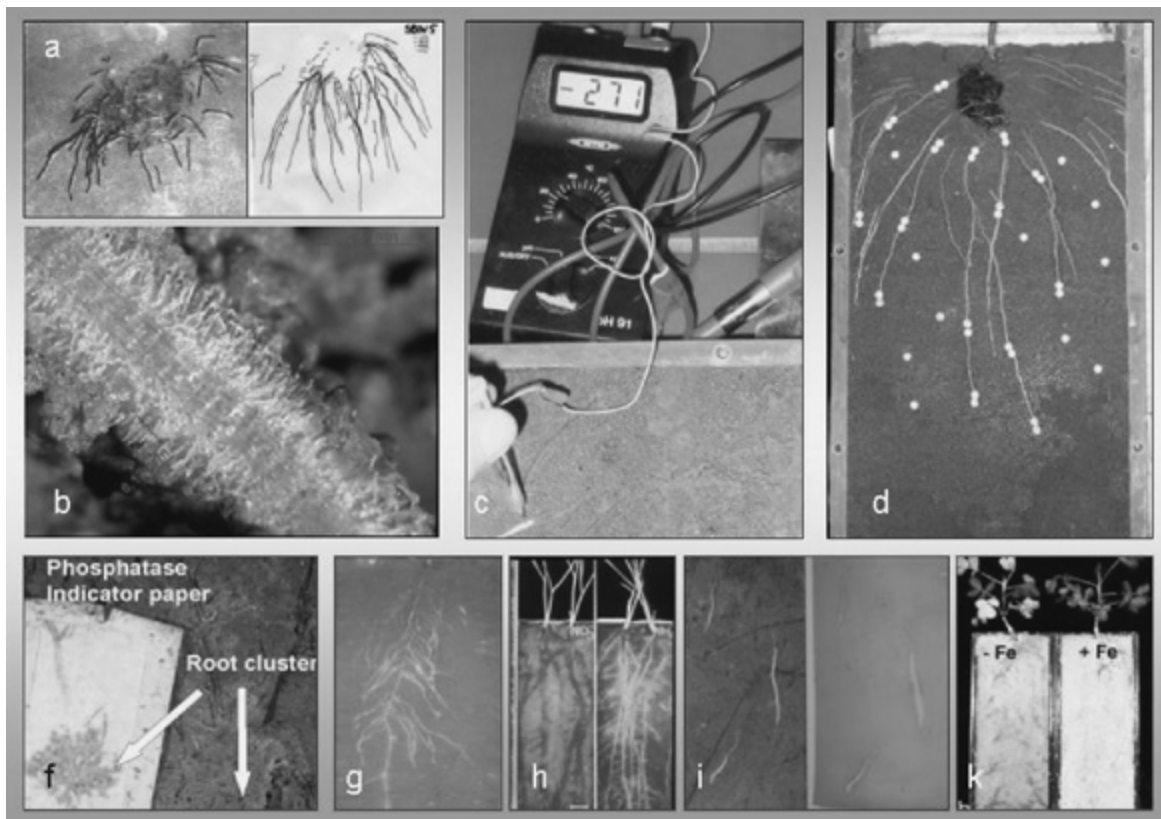
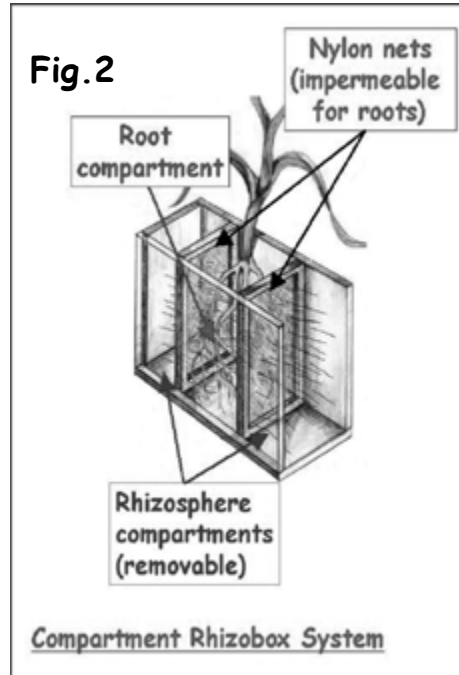

Fig. 3: Rhizobox applications: Monitoring of root growth (a); length measurements of root hairs (b); determination of rhizosphere pH with antimony micro-electrodes (c); collection of rhizosphere soil solution with filter paper (d); detection of root-induced chemical changes: acid phosphatase activity (f); Mn-reduction with Mn-oxide indicator paper; pH-changes with bromocresol-purple agar (h); aluminium complexation with aluminon-agar; iron-III reduction with BPDS-agar (for details see chapter 3.1.: Root exudates and organic composition of plant roots).

ID	11_Sandnes_a
Author	Sandnes, Arne Norwegian Forestry Association (NORSKOG), Lilleakerveien 31, Postboks 123, Lilleaker, 0216 Oslo, Norway arne.sandnes@norskog.no
Parameter	Low molecular weight organic acids, pH, conductivity, mineral elements
Soil type	Acid forest soils
Plant species	Norway spruce (<i>Picea abies</i>) and silver birch (<i>Betula pendula</i>)
System	Root windows at field sites and field soil in rhizoboxes used indoors
Method	Root windows, rhizoboxes and micro suction cups
Method description	See Dieffenbach et al. (1997). A 0.5 m ² area in front of each root window was irrigated using 50 mm deionised water about 15 hours before sampling by micro suction cups. The rhizoboxes were continuously irrigated with deionised water by porous ceramic cups adjusted to a water potential of -40 hPa.
Do's, don'ts, potential limitations, untested possibilities	<p><i>Root windows:</i> Secure good contact between the transparent glass plate and the soil by warm-bending the plate prior to installation (reduces the condensation and gives better visibility of root growth etc.).</p> <p><i>Rhizoboxes:</i></p> <ul style="list-style-type: none"> • Compaction of dried and sieved soil to simulate the field soil density may restrict the root growth. • Irrigation by deionised water induced nutrient deficiencies in one-year-old plants of spruce and birch growing in rhizoboxes over a period of 6 months. <p><i>Micro suction cups:</i></p> <ul style="list-style-type: none"> • They are fragile and the ceramic may influence the amount and composition of mineral elements and organic acids by e.g. sorption. • They should be classified according to their suction potential. Reasonably similar cups should be used in the same grid. • The retrieval of solution depends strongly on soil texture, soil contact and the water content. At the field sites, reliable sampling occurred first after artificial irrigation was implemented.
References	<p>Dieffenbach, A.; Göttlein, A.; Matzner, E. 1997. In-situ soil solution chemistry in an acid forest soil as influenced by growing roots of Norway spruce (<i>Picea abies</i> [L.] Karst.). Plant and Soil 192: 57-61.</p> <p>Sandnes, A. 2003. Rhizosphere chemistry and root exudates of Norway spruce and silver birch. Doctor scientiarum thesis 2003:43. Agricultural University of Norway.</p>
Links	Organic acid analysis, see method sheet 31_Eldhuset
Additional information	<p><i>Detailed soil information:</i></p> <ul style="list-style-type: none"> • Norway spruce: fluvial sediments of sandy loam, 50% sand, 44% silt, pH_{H2O} 4.4, BS 81% (former agricultural field) • Silver birch: fluvial sediments of silty loam, 17% sand, 77% silt, pH_{H2O} 5.1, BS 92% (former agricultural field)

ID	11_Sandnes_b
Author	Sandnes, Arne Norwegian Forestry Association (NORSKOG), Lilleakerveien 31, Postboks 123, Lilleaker, 0216 Oslo, Norway arne.sandnes@norskog.no
Parameter	Low molecular weight organic acids, pH, conductivity
Soil type	Artificial: Soda glass beads
Plant species	Norway spruce (<i>Picea abies</i>) and silver birch (<i>Betula pendula</i>)
System	Sterile plant cultivation in microcosms
Method	Microcosms using soda glass beads as solid growth substrate
Method description	See Hodge et al (1996). Glass beads were acid washed by H ₂ SO ₄ , and seeds surface sterilized by H ₂ O ₂ (spruce) and NaOCl (birch).
Do's, don'ts, potential limitations, untested possibilities	<p><i>Microcosms:</i></p> <ul style="list-style-type: none"> • Cover the bottom chamber by e.g. Al-foil to minimize light interaction on root growth. • All handling (planting, sampling, change of nutrient solution etc.) must be done in sterile air cabinets. <p><i>Soda glass beads:</i></p> <ul style="list-style-type: none"> • Released Si, Na, Ca and B. • Increased the pH (~2 units) and conductivity in the percolate. • May retain organic acids and thus underestimate root exudation. <p><i>Surface sterilization of seeds and germination:</i></p> <ul style="list-style-type: none"> • Infection risk after surface sterilization varies between seed lots. • Bacterial infection may be reduced using Carbamicillin in the malt agar. • Seed caps should be removed before the the germinated. seedlings are placed onto the glass beads due to the infection risk.
References	<p>Hodge, A; Grayston, S.J.; Ord, B.G. 1996. A novel method for characterization and quantification of plant root exudates. <i>Plant and Soil</i> 184: 97-104.</p> <p>Sandnes, A. 2003. Rhizosphere chemistry and root exudates of Norway spruce and silver birch. Doctor scientiarum thesis 2003:43. Agricultural University of Norway.</p> <p>Sandnes, A.; Eldhuset T.D. 2003. Soda glass beads as growth medium in plant cultivation experiments. <i>J. Plant Nutr. Soil Sci.</i> 166: 660-661.</p>
Links	Organic acid analysis, see method sheet 31_Eldhuset

ID	11_Vierheilig
Author	Vierheilig, Horst Institut für Pflanzenschutz (BOKU); Departement für Angewandte Pflanzenwissenschaften und Pflanzenbiotechnologie, Peter-Jordan-Str. 82; A-1190 Wien/Austria; nonhorst@boku.ac.at; ++43 1 47654-3391
Parameter	Inoculation of root systems with arbuscular mycorrhizal fungi or pathogenic fungi
Soil type	Any soil or artificial substrates like sand or expanded clays
Plant species	Any plant
System	Split-root system
Method	Split-root system for inoculation with different organisms at the same or different times
Method description	<p>Roots of e.g. monocotyledones are easy to separate and to plant in different compartments. When plants do have tap roots it is a bit more difficult. Several days after seed germination, you cut the tap root (you leave about 1 cm) and plant the plant in pots in a growth substrate (I prefer to use a substrate with few organic particles. Organic particles are hard to wash off the roots). After several weeks of plant growth, plants are taken out of the pots and the growth substrate is washed off the root.</p> <p>The split-root compartment system consists of three compartments: an inoculum compartment (plants growing in the compartment in presence of an AMF inoculum in a silicate sand, expanded clay, soil substrate) and two split-root compartments.</p> <p>The two split-root compartments are glued together, but separated by a PVC plate. The root system of the test plants is divided into two equal parts and planted in the two split-root compartments. As the PVC plate separating the two split-root compartments is impermeable for roots and hyphae, one part of the root system can be inoculated, whereas the other part is still non-inoculated. The glued split-root compartments are joined on one side with an inoculum compartment from which they are separated by a nylon screen (60 µm mesh size) which can be penetrated by fungal hyphae but not by roots. Joining the inoculum compartment to the split-root plant compartments thus results in a fast root colonization of one side of the split-root system (for details see Vierheilig et al. 2000).</p> <p>To obtain root colonization on the second side of the split-root system, an inoculum compartment is joined to the second side.</p>
Do's, don'ts, potential limitations, untested possibilities	<ul style="list-style-type: none"> Plants can be pre-colonized by an AMF on one side of a split-root system and later on or simultaneously be inoculated with an AMF or a pathogen on the second side of the split-root system. We noticed that inoculation with a pathogen can easily be obtained when you incline the whole system in a about 45° angle. Thus roots grow on the surface of one compartment and the pathogen inoculum can be applied directly to the roots.
References	<p>Catford, J.G. ; Staehelin, C. ; Lerat, S.; Piche, Y. ; Vierheilig, H. 2003. Suppression of arbuscular mycorrhizal colonization and nodulation in split-root systems of alfalfa after pre-inoculation and treatment with Nod factors J. Exp. Bot. 54: 1481-1487.</p> <p>Vierheilig, H. Lerat, S.; Piche, Y. 2003. Systemic inhibition of arbuscular mycorrhiza development by root exudates of cucumber plants colonized by Glomus mosseae. Mycorrhiza 13: 167-170.</p> <p><i>A very detailed description of the split-root system you find in:</i> Vierheilig, H. et al. 2000. Soil Biol. Biochem. 32: 589-595.</p>

ID	11_Volante
Author	Volante, Andrea ¹ ; Lingua, Guido ¹ ; Cresta, Andrea ² ; Ariati, Luigi ³ ; Berta, Graziella ¹ ¹ Dipartimento di Scienze dell'Ambiente e della Vita, Università degli Studi del Piemonte Orientale "Amedeo Avogadro", Via G. Bellini 25/g, 15100 Alessandria, Italy volante@med.unipmn.it; ++39 0131 5137210 guido.lingua@unipmn.it; ++39 0131 360233 graziella.bera@unipmn.it; ++39 0131 360232 ² IDROCONS Srl, Strada Savonesa 9, 15050 Rivalta Scrivia, Tortona, Italy info@idrocons.com; ++39 0131 872935 ³ Dipartimento di Medicina Interna e Terapia Medica, Laboratorio di Idrologia Chimica e Analisi Ambientali, Università degli Studi di Pavia, Piazza Botta 11, 27100 Pavia, Italy; luigi.ariati@unipv.it; ++390382986349
Parameter	Concentration of volatile pollutants in contaminated substrates
Soil type	Quartz sand + powdered vermiculite (50% v/v)
Plant species	Leek (<i>Allium porrum</i>)
System	Mesocosm
Method	Mesocosm for plant growth and head space gas-chromatography
Method description	<p><i>Preparation of the plants</i></p> <p>Leek plantlets are initially grown in 50 ml pots, in the above mentioned substrate. Colonization by arbuscular mycorrhizal fungi is achieved inoculating with fungal spores in liquid suspension, distributed at the base of each plantlet. After 50 days in a growth chamber [(24°C, 16 h light/day), supplemented 3 times/week with Long-Ashton nutrient solution (Hewitt, 1966), modified with a 32 µM P concentration (Trotta et al., 1996), plants are transferred into the mesocosm. Non mycorrhizal plants are prepared as negative control.</p> <p><i>Mesocosm growth</i></p> <p>The plants are transferred, with the entire mass of substrate, into 750 ml pots filled with the vermiculite-based substrate, supplemented with 1% (w/w) active carbon containing the polluting hydrocarbons. As further negative controls, pots containing substrate and no plants nor fungi are prepared. The pots are transferred into the mesocosm system, i. e. a glass self sealing cabinet, as shown in the picture below. One mesocosm is used for each of the pollutants, plus a reference one without any contaminant. Pots are placed on separate trays, according to the fungal treatment, to avoid cross-contaminations. At the end of the growth period the entire volume of inner air is collected by means of a vacuum pump, and run through a carbon cartridge directly connected to the pump, in order to adsorb the evaporated pollutants. For substrate analyses, samples of the mixture in the pots are collected and sealed in glass tubes; the quantification of the hydrocarbons is performed by head-space gas-chromatography.</p>

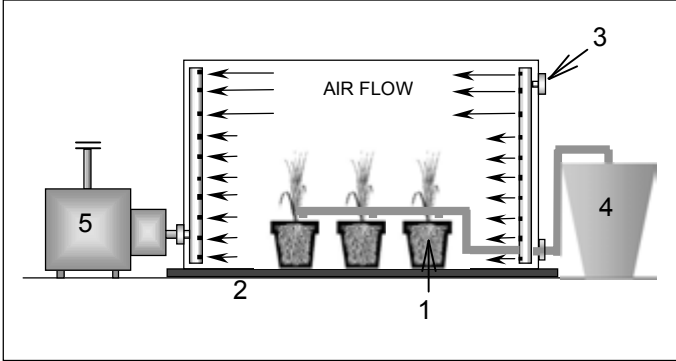
<p>Do's, don'ts, potential limitations, untested possibilities</p>	<ul style="list-style-type: none"> • This method is suitable to trace the fate of volatile compounds, either supplemented or produced by the plants, which could evaporate and be dispersed in an open environment; moreover, it can be used for the growth of plants under particular and controlled conditions (i.e. specific composition of the air, presence of pollutants in the air, etc.). • All the necessary operations during the growth period (e. g. watering of plants, renewing of the internal air if required) can be performed by means of the internal tube system, therefore the experimental conditions are preserved. • Thanks to the collection of the inner air by means of a tube system, a complete balance of the pollutants can be performed, also including the fractions which have been released from the substrate. • In case of high levels of humidity, a significant percentage of the volatile compounds could be solubilized in the water drops forming along the cabinet walls. Therefore, if pollutants are water-soluble, also the water inside the cabinets should be sampled and analyzed. • Being entirely built in glass, the system can be freely supplemented with additional light systems if required. • At least a rough calculation of the CO₂ and O₂ balances should be done and the number of plants in the mesocosm should be carefully considered.
<p>References</p>	<p><i>Contains the original protocol for the preparation of the Long-Ashton nutrient solution:</i> Hewitt, E.J. 1966. Commonwealth Agricultural Bureaux Technical Communication 22: 190–191.</p> <p><i>Contains the protocol for the modified Long-Ashton nutrient solution:</i> Trotta, A; Varese, G.C.; Gnani, E.; Fusconi, A.; Sampò, S; Berta, G. 1996. Plant and Soil 185: 199-209.</p>
<p>Additional information</p>	<p>Schematic description of the system:</p>  <ol style="list-style-type: none"> 1) Plants grown in polluted soil 2) Self-sealing layer 3) System for air collection and renewing 4) Watering system 5) Vacuum pump for air



ID	12_Eich_Greatorex
Author	Eich-Greatorex, Susanne Norwegian University of Life Sciences, Department of Plant and Environmental Sciences, PO Box 5003, N-1432 Aas, Norway susanne.eich@umb.no; ++47 64 96 55 72
Parameter	Root growth direction and length in relation to chemical gradients
Soil type	Acid-washed sand (acid forest soil)
Plant species	Spruce (<i>Picea abies</i>), Timothy (<i>Phleum pratense</i>)
System	Root observation chamber
Method	Visual evaluation and WinRhizo analysis of root scans
Method description	Plant seedlings of either Norway spruce or timothy were grown in root observation chambers consisting of two Plexiglas plates held apart by a plastic tube. Ion-exchange resin bags were inserted on either side of one plant seedling in order to introduce chemical gradients of different types (see Chapter 1.1). At the end of the experiments, one of the Plexiglas plates was replaced by a nail board with nails at a distance of 1 cm from each other, and the root system was washed out on the nail board. This allowed a visual evaluation of root growth towards resin bags loaded with either nutrients or AlCl ₃ . The root system was then separated according to its distance to the resin bags, and root length was determined using an optical scanner and the Win RHIZO software.
Do's, don'ts, potential limitations, untested possibilities	Sand as a growth medium was easy to wash away with a gentle stream of water even after several weeks of root growth. Tests with different sieve sizes to collect the sand and possible root fragments showed that root loss was negligible. Finer-textured soils and plants with faster growing root systems may be more difficult to use.
References	James, B.R.; Bartlett, R.J.; Amadon, J.F. 1985. A root observation and sampling chamber (rhizotron) for pot studies. <i>Plant Soil</i> 85: 291-293. Eich-Greatorex, S. 2003. Root distribution as influenced by the chemical conditions in the root-soil environment. Doctor scientiarum theses 2003:13. Agricultural University of Norway.

ID	12_Futsaether
Author	Futsaether, Cecilia; Oxaal, Unni; Vollsnes, Ane V. Department of Mathematical Sciences and Technology, Norwegian University of Life Sciences, P.O. Box 5003, N-1432 Aas, Norway cecilia.futsaether@umb.no; unni.oxaal@umb.no; ane.vollsnes@umb.no; ++47 64965400
Parameter	Anatomical and morphological studies of living tissue, root development and architecture, water flow velocities in living tissue, root-soil interface and bulk soil.
Soil type	Artificial media or soil mixtures free of ferromagnetic materials
Plant species	Most plant species
System	Laboratory studies
Method	Magnetic resonance imaging (MRI)
Method description	<p>In MRI a sample is placed in the bore of a superconducting magnet and a series of radio frequency pulses and magnetic field gradients are used to determine the concentration and relaxation properties of protons mainly those associated with water. The images generated from this information reflect the spatial distribution and physical status (water mobility etc) of water in the sample.</p> <p>MRI is a nondestructive and noninvasive technique enabling changes in water distribution in living tissue, the root-soil interface and bulk soils to be observed. Thus, root development as well as water uptake by roots of plants growing in containers can be monitored as a function of time. It is also possible to generate three-dimensional reconstructions of entire intact root systems or water depletion zones surrounding the roots within the potting container. Magnetic resonance microimaging provides high spatial resolution typically 10 μm to a few hundred μm allowing anatomical and morphological studies of plant tissue.</p> <p>Flow sensitive MRI can be used to measure water flow under <i>in vivo</i> condition. This technique has been used to study fluid transport in porous media and water flow in plant tissue such as the phloem and xylem. It is also possible to form images of plant tissue from protons bound to different metabolites such as sucrose, amino acids or aromatic oils instead of water. These images provide a map of the metabolite distribution within the tissue.</p>
Do's, don'ts, potential limitations, untested possibilities	<ul style="list-style-type: none"> • MRI can suffer from resolution and contrast problems. It can also be time-consuming. • Increasing the spatial resolution increases the image acquisition time which can often range from minutes to hours. Increasing the signal to noise ratio by increasing the number of scans used in the signal averaging also increases the acquisition time. • The spatial resolution of magnetic resonance microimaging does not match that of conventional light microscopy. The image contrast is also completely different from light microscopy as it reflects the water/metabolite distribution. • Satisfactory images of roots hidden in soil filled containers depend on good contrast between the roots and the soil. Soil composition can have a large effect on image quality. Minute amounts of ferromagnetic material can distort the magnetic fields such that roots cannot be distinguished

	<p>from the surrounding medium. Controllable soil mixtures or artificial media should be used to prevent such problems.</p> <ul style="list-style-type: none"> • High water content in the soil can give rise to large signals which overshadow the smaller roots signals, making it difficult to identify the roots. • MRI requires highly specialized equipment and skilled technicians.
References	<p>Antonsen, F.; Johnsson, A.; Futsaether, C.; Krane, J. 1999. Nuclear magnetic resonance imaging in studies of gravitropism in soil mixtures. <i>New Phytol.</i> 142: 59-66.</p> <p>Brown, J.M.; Kramer, P.J.; Cofer, G.P.; Johnson, G.A. 1990. Use of nuclear magnetic resonance microscopy for noninvasive observations of root-soil water relations. <i>Theor. Appl. Climatol.</i> 42: 229-236.</p> <p>Chudek, J.A.; Hunter, G. 1997. Magnetic resonance imaging of plants. <i>Progress in Nuclear Magnetic Resonance Spectroscopy</i> 31: 43-62.</p> <p>Kockenberger, W. 2001. Functional imaging of plants by magnetic resonance imaging. <i>TRENDS in plant science</i> 6: 286-292.</p> <p>Southon, T.E.; Jones, R.A. 1992. NMR imaging of roots: methods for reducing the soil signal and for obtaining a 3-dimensional description of the roots. <i>Physiol. Plant.</i> 86: 322-328.</p>

ID	12_Gahoonia
Author	Gahoonia, Tara Singh The Royal Veterinary and Agriculture University, Plant and Soil Sciences, Thorvalsensvej 40, 1871 Frederiksberg C, Denmark tsg@kvl.dk; ++45 35283497
Parameter	Root hairs
Soil type	Any, but works better in sandy soils
Plant species	Any
System	Pots, field soil
Method	Sampling and cleaning of soil-grown roots for root hair studies
Method description	<p>Soil cores containing roots are sampled using a sharp knife, immersed in water overnight and cleaned using Ultrasound. Root hairs on the cleaned roots can be measured using Image analysis.</p> <ol style="list-style-type: none"> 1. Take soil cores with intact roots using a sharp knife or augur from the field. If plants are grown in small pots, especially for root or root hair measurements, you may immerse the whole pot in water tub or deep tray as a measure of the minimum disturbance. Otherwise, for taking the soil cores from the field or pot, the knife must be sharp so that it cuts root immediately and in place without dragging of roots. 2. Immerse the soil core in plenty of water overnight, preferably in the dark cold room (ca. 5°C). It would help if you place two bricks in a deep tray, then place a sieve (ca. 2 mm) over the bricks and then place the soil core over the sieve. Now fill the tray with water. This way loose soil will keep falling through the sieve. Keep the soil core immersed in water. 3. Root will usually float next day or will stay on the sieve. You can hand-shake the sieve to get rid of soil. Then pick up the roots using forceps or kitchen sieve. After this you can cut root pieces of interest for root hair measurements and even store them for 2-3 days at 4°C. In many cases the soil (more in clay soils) may be hanging on and in between root hairs. In that case, apply sonic treatment as followed. 4. Place the root pieces of interest in an ultra sound bath (e.g. Brandon, 5200, 120 W and 47 k Hz,). Start the ultra sound bath for 5-10 minutes, but in some cases longer, especially for roots grown in clay soils. Try switching off the bath and start it again during the treatment. It helps to get rid of soil particles from the roots. Now you would have clear root with eventual root hairs on them. Pick the roots with forceps from the bath and place them in Petri dishes. Do not forget to identify Petri dishes with appropriate labels before hand. After this root samples should be ready for root hair measurements using the using Image analysis system e.g. Quantimat 500+ (Leica). Remember processing without long storage gives better pictures and measurements.
Do's, don'ts,	Use sharp knife which cuts roots in place without dragging them through the soil profile. Disturb the roots minimum possible.
References	Gahoonia, T.S.; Nielsen, N. E. 1997. Variation in root hairs of barley cultivars doubled soil phosphorus uptake. <i>Euphytica</i> 98: 177-182.

ID	12_Hargreaves
Author	Hargreaves, Caroline ¹⁾ ; McNeill, Ann ²⁾ ; Gregory, Peter ³⁾ ¹⁾ University of Reading, Department of Soil Science, Whiteknights, PO Box 233, Reading RG6 6DW; c.e.hargreaves@reading.ac.uk ²⁾ University of Adelaide, Soil and Land Systems, Australia 5005 ann.mcneill@adelaide.edu.au ³⁾ Scottish Crops Research Institute, Dundee DD2 5HA; peter.gregory@scri.ac.uk
Parameter	Root growth and physical soil changes due to root growth, <i>in-situ</i>
Soil type	Any suited to system X-ray energy
Plant species	Any with root-diameter suited to system X-ray resolution (Medical X-ray CT- <i>Lupinus angustifolius</i> , <i>Pisum sativum</i>)
System	Pots in controlled conditions
Method	Non-invasive 3-D X-ray analysis of plant-soil interactions
Method description	<p><i>Plant treatment</i> seed surface sterilised, 3% bleach, germinated on trays in dark at 25°C</p> <p><i>Sample preparation:</i> penetrometer probe 30° tip, recessed shaft used to identify and reliably recreate resistance at specific bulk densities, Urrbrae loam - 15% gravimetric water content; Pots 8.1 cm diameter by 15cm, gauze at base of pots to prevent soil/plant loss. Control 13 cm soil at 1.3 Mgm⁻³ <1 MPa, top 1.5 mm drill bit used to make hole for radicle 1.5 cm deep, 1 cm loose soil on top 13-14 cm. Treatment 1: 0-7cm 1.45 Mgm⁻³ 2 MPa, 8-13 cm <1 MPa, drill bit and top 1cm as control, treatment 2: 0-7cm 1.55 Mgm⁻³ 4 MPa, 8-13cm <1 MPa, drill bit and top 1cm as control.</p> <p><i>Analysis</i> At intervals during plant development cores were scanned with Aquilion (Toshiba, Japan) medical X-ray computed tomography (CT) scanner 1mm³ resolution. 3D images rendered with Amira (Template Graphics Software, USA) image analysis software and analysed for root length, surface area and volume. Destructive sampling involving root washing and 2D flat-bed scanning, to measure the total length and volume of all roots, was also carried out on the cores used for 3D analysis (Kolesik et al., 2004).</p> <p><i>3D image analysis</i> was carried out using Amira visualisation software, standard software (e.g. IDL, Volume J) could be used with adequate hardware. WinRHIZO used to analyse 2D root data.</p>
Do's, don'ts, potential limitations, untested possibilities	<ul style="list-style-type: none"> • Dense soils in low energy beams micro CT cause artefacts preventing accurate readings, high energy beams visualise soils more accurately but can damage plants and lose plant attenuation information. • Current 'off the shelf' high resolution X-ray micro-CT scanners have higher energy beams and often longer scanning/visualisation times than ideal for work with living plants. Med CT visualises roots >1mm³ • Soils with highly attenuating ions such as Iron/Calcium, are not read reliably by low energy beams. If a system is built to identify root (low attenuation) growth, it may not be able to accurately measure small

	physical differences to soil (highly attenuating) characteristics.																																				
References	<p>Kolesik, P.; Fouard, C.; Prohaska, S.; McNeill, A. 2004. Automated method for non-destructive 3D visualisation of plant root architecture using X-ray tomography. 4th International Workshop on Functional-Structural Plant models, CIRAD Montpellier, France, 7-11 June 2004, p. 27.</p> <p>Jenneson, P.M.; Gilboy, W.B.; Morton, E.J.; Gregory, P.J. 2003. An X-ray micro-tomography system optimised for the low-dose study of living organisms. Applied Radiation and Isotopes 58: 177-181</p> <p>Gregory, P.J.; Hutchison, D.J.; Read, D.B.; Jenneson, P.M.; Gilboy, W.B. Morton, E.J. 2003. Non-invasive imaging of roots with high-resolution X-ray micro-tomography. Plant and Soil 255: 351-359.</p>																																				
Links	<p>Ann McNeill: http://www.ees.adelaide.edu.au/people/soil/amcnei01.html</p> <p>Peter Gregory: http://www.shes.rdg.ac.uk/staff/AcStaffDetails.asp?PID=PJG</p> <p>Paul Jennesson: http://www.ph.surrey.ac.uk/profiles/academics?s_id=67</p>																																				
Additional information (see also colour plates on p. 521)	<div style="display: flex; justify-content: space-around;"> <div style="text-align: center;"> <p>a</p>  </div> <div style="text-align: center;"> <p>b</p>  </div> </div> <div style="margin-top: 20px;"> <table border="1" style="margin-top: 10px;"> <caption>Data points estimated from Figure 2</caption> <thead> <tr> <th>Soil Type</th> <th>Bulk Density (g/cm³)</th> <th>LAC</th> </tr> </thead> <tbody> <tr> <td>Peat</td> <td>0.2</td> <td>-0.7</td> </tr> <tr> <td>Peat</td> <td>0.3</td> <td>-0.6</td> </tr> <tr> <td>Kaolin</td> <td>0.3</td> <td>-0.1</td> </tr> <tr> <td>Burwell</td> <td>0.6</td> <td>1.8</td> </tr> <tr> <td>Kaolin</td> <td>0.8</td> <td>1.2</td> </tr> <tr> <td>Sonning</td> <td>1.1</td> <td>2.2</td> </tr> <tr> <td>Potter's Clay</td> <td>1.1</td> <td>2.4</td> </tr> <tr> <td>Sonning</td> <td>1.2</td> <td>2.3</td> </tr> <tr> <td>Potter's Clay</td> <td>1.3</td> <td>2.3</td> </tr> <tr> <td>Burwell</td> <td>1.1</td> <td>2.6</td> </tr> <tr> <td>Sand</td> <td>1.5</td> <td>2.4</td> </tr> </tbody> </table> </div> <p>Fig. 1a. 14-day Lupin root in 1 and 4MPa soil Adelaide Medical CT.</p> <p>Fig. 1b. Two 3-day-old wheat seedlings, Reading micro CT.</p> <p>Fig. 2. Dry bulk density and Linear Attenuation Coefficient (LAC) of soils sieved <250µm loose and compacted, as scanned at Reading, low energy micro CT. Note: negative values of peat and inaccurate reading of highly attenuating Burwell and Potters clay.</p>	Soil Type	Bulk Density (g/cm ³)	LAC	Peat	0.2	-0.7	Peat	0.3	-0.6	Kaolin	0.3	-0.1	Burwell	0.6	1.8	Kaolin	0.8	1.2	Sonning	1.1	2.2	Potter's Clay	1.1	2.4	Sonning	1.2	2.3	Potter's Clay	1.3	2.3	Burwell	1.1	2.6	Sand	1.5	2.4
Soil Type	Bulk Density (g/cm ³)	LAC																																			
Peat	0.2	-0.7																																			
Peat	0.3	-0.6																																			
Kaolin	0.3	-0.1																																			
Burwell	0.6	1.8																																			
Kaolin	0.8	1.2																																			
Sonning	1.1	2.2																																			
Potter's Clay	1.1	2.4																																			
Sonning	1.2	2.3																																			
Potter's Clay	1.3	2.3																																			
Burwell	1.1	2.6																																			
Sand	1.5	2.4																																			

ID	12_Helmisaari
Author	Helmisaari, Heljä-Sisko; Makkonen, Kirsi Finnish Forest Research Institute, Vantaa Research Centre, P.O.Box 18, FI-01301 Vantaa, Finland; helja-sisko.helmisaari@metla.fi; ++358 10 2112533
Parameter	Root biomass and necromass
Soil type	Upland forest soil
Plant species	Scots pine (<i>Pinus sylvestris</i>), Norway Spruce (<i>Picea abies</i>), Birch (<i>Betula sp.</i>), understorey species groups (shrubs, grasses, herbs)
System	Field and laboratory studies
Method	Root ingrowth core method
Method description	<p>Root-free mesh bags = root ingrowth cores (mesh size of the bag 4-6 mm) are inserted into the soil as follows: the hole in the soil is made by a soil corer, then a plastic tube is put into a nylon net bag (the diameter of the tube will be about the same as the diameter of the soil core, 3.6 to 5 cm) and the tube with the net bag will be put into the soil hole. The net bag is then slowly filled with homogeneous, sieved, practically root-free mineral soil (upper 30 cm) from the same site, and the plastic tube is lifted up little by little at the same time packing the soil gently to about the original bulk density. The net bags are then left in the soil. Starting after one year (in boreal conditions) the root ingrowth cores can be taken up using a special sharp spade or in some cases a large corer, depending on the site. During the first one-two years the intervals of sampling can be long (in boreal conditions), but from the third growing season sampling should be in short intervals, e.g. monthly. At sampling, the soil around the ingrowth core must be cut away using special scissors so that the roots in the ingrowth core remain untouched. Ingrowth cores are wrapped in a plastic sheet, and stored frozen until sorting. In the laboratory, melting but still partly frozen ingrowth cores are divided into e.g. 10 cm subsamples. Subsamples are carefully wet-sieved free of soil on a mesh screen, and further classified using microscopes into tree species or understorey vegetation species groups and according to diameter (usually <1 mm, 1-2 mm, 2-5 mm, but also <0.5 mm, 0.5-1 mm etc.) and physiological status (live or dead). Living roots of different species are distinguished on the basis of their mycorrhizas, colour and morphology. Dead roots can be distinguished from living roots on the basis of their colour and consistency. Roots under sorting are all the time in water on Petri dishes to avoid drying, and stored overnight at 5 °C. Subsamples of sorted finest living roots (e.g. random 10% of each sample) can undergo special measurements, e.g. mycorrhizal tip counting (per root weight or length) and morphological characteristics.</p> <p>Finally, samples are placed in tiny paper bags, dried (48 h, 70°C) and dry mass weighed. Usually a part of the samples is ashed since soil often remains, especially within ectomycorrhiza clusters, and the dry weight should be corrected for ash content.</p>
Do's, don'ts, potential limitations	The root ingrowth core method is suitable for comparing the potential of annual (fine) root production between different site types or experimental treatments. The method is quite inconvenient in very stony soil.
References	<p>Helmisaari, H.-S.; Makkonen, K.; Olsson, M.; Viksna, A.; Mälkönen, E. 1999. Fine root growth, mortality and heavy metal conc. in limed and fertilized <i>Pinus sylvestris</i> (L.) stands in the vicinity of a Cu-Ni smelter in SW Finland. <i>Plant Soil</i> 209: 193-200.</p> <p>Makkonen, K.; Helmisaari, H.-S. 1999. Assessing fine-root biomass and production in a Scots pine stand – comparison of soil core and root ingrowth core methods. <i>Plant Soil</i> 210: 43-50</p> <p>Vogt, K.A.; Persson, H. 1991. Measuring growth and development of roots. In: Lassoie, J.P.; Thomas, M.H. (eds.) <i>Techniques and approaches in forest tree ecophysiology</i>. CRC Press. Boca Raton, FL. Pp. 477-501</p>

ID	12_Himmelbauer
Author	Himmelbauer, Margarita L. Department of Water, Atmosphere, and Environment, University of Natural Resources and Applied Life Sciences Vienna (BOKU), Muthgasse 18, 1190 Vienna, Austria; ml.himmelbauer@boku.ac.at; ++43 1 36006 5450
Parameter	Root growth, density and morphology, root spatial distribution
Soil type	Chernozem, serpentine soils, artificial substrates
Plant species	Cereals (barley, wheat, maize), <i>Thlaspi goesingense</i> , <i>Salix sp.</i>
System	Field and laboratory studies
Method	Field: profile-wall method, soil-core method; Laboratory: pot experiments, root cleaning procedure, rhizobox; Image analysis: root scans and digital photos
Method description	<p>Root growth and spatial distribution in the field is studied on horizontal and vertical maps using sampling grids (<i>profile-wall method</i>). Root morphological measurements (mass, length, surface area, specific root length, average diameter and classes, and related ratios also used for evaluating of uptake by modeling) are carried out on samples (<i>soil-core method</i>) taken with cylindrical augers (10 and 70 cm length, 7 cm diameter). Samples storage- in freezer. In the lab roots are carefully washed using a hydro pneumatic elutriator over sieves of 0.2 - 1mm mesh size, cut and stained if required, and scanned.</p> <p>Scanning in a water layer (ordinary for fine roots). Images are then analyzed with ROOTEDGE and/or WinRHIZO image analyses systems. Digital photos of a root monolayer (matt) developed in rhizoboxes are taken and software analyzed (RhizoTron).</p> <p>After scanning, roots are evaluated for fresh mass (using filter paper or short low speed centrifugation) and dry mass (24 - 48h at 70°C).</p>
Do's, don'ts, potential limitations, untested possibilities	<p>The <i>soil profile wall method</i> is appropriate for studying the whole root system, for describing spatial distribution patterns of roots (mostly coarse) in relation also to the local soil conditions (see figure below). It does not give a detailed information at a single root level, e.g. root diameter or surface area, etc.; laborious and destructive method; difficulties in very sandy or clayey soils.</p> <p>The <i>soil-core method</i> is suited for frequent sampling and gives more comprehensive information about single root morphology. It is also a destructive method, obtained results show some sampling position dependency, inappropriate for stony or very wet soils. Following procedures in the laboratory are time and labor consuming.</p> <p><i>Image analysis systems</i> provide a prompt evaluation of root morphological characteristics. A certain testing should be done at the beginning of the processing related to the root sample treatment (staining or not, acceptable scanning density, scanning threshold value, etc.). Requirements for good computer and scanner capabilities.</p> <p>Results for root length are less sensitive to the root sample processing as for diameter and area. ROOTEDGE plus scanner with an additional light adapter from the top satisfied for length measurements as it is free of charge and requires less computer memory than WinRHIZO. For diameter measurements the flexible threshold of WinRHIZO, automatically adjusted to the current image contrast, is a certain advantage against the fixed one for ROOTEDGE. In addition, WinRHIZO offers more comprehensive analyses.</p>

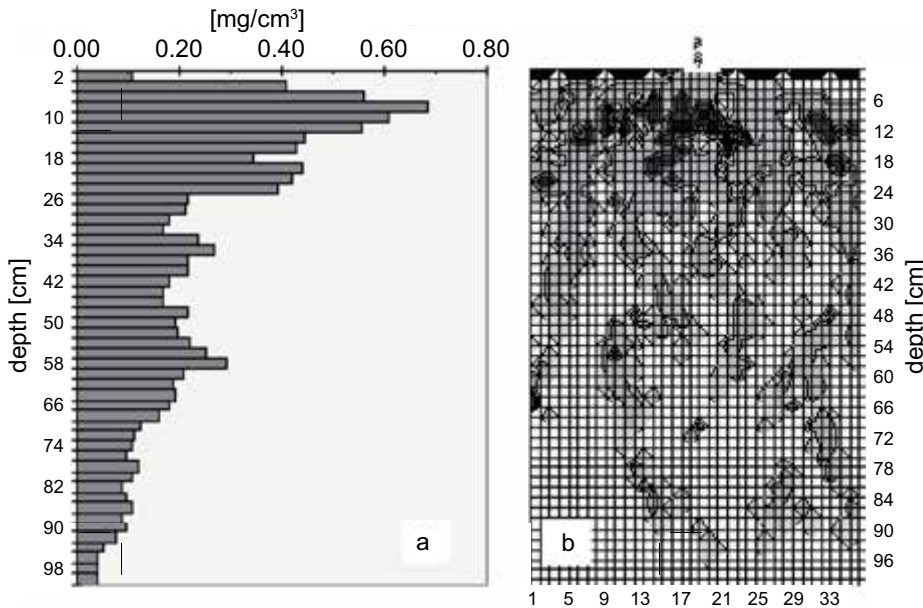
References	<p>Atkinson, D. 2000. Root characteristics: Why and what to measure. In: Smit, A.; Bengough, A.; Engels, C.; van Noordwijk, M.; Pellerin, S.; van de Geijn, S. (eds.) Root methods. A handbook. Springer, pp. 1-32.</p> <p>Box, J.E. 1996. Modern methods for root investigations. In: Waisel, Y. <i>et al.</i> (Eds.). Plant Roots: The hidden half. Marcel Dekker, New York, pp. 193-237</p> <p>Kaspar, T.C.; Ewing, R.P. 1997. ROOTEDGE: Software for measuring root length from desktop scanner images. Agron. J. 89: 932-940.</p> <p>Smucker, A.J.; Mc Burney, S.; Srivastava, A. 1982. Quantitative separation of roots from compacted soil profiles by the hydropneumatic elutriation system. Agron. J. 74: 500–503.</p> <p>Himmelbauer, M.L.; Loiskandl, W.; Kastanek, F. 2004. Estimating length, average diameter and surface area of roots using two different Image analyses systems. Plant and Soil 260: 111-120.</p> <p>Himmelbauer, M.L.; Loiskandl, W.; Kastanek, F. 2004. Comparison of WinRHIZO and ROOTEDGE Image analyses systems. Advantages and shortcomings. In: ASA-CSSA-SSSA Int. Ann. Meeting with CSSS, Oct 31 - Nov 4, 2004, Seattle, USA, (CDROM) ASA-CSSA-SSSA Headquarters</p> <p>Himmelbauer, M.L.; Puschenreiter, M.; Schnepf, A.; Loiskandl, W.; Wenzel, W.W. 2005. Root morphology of THLASPI GOESINGENSE Hálácsy grown on a serpentine soil. J. of Plant Nutrition and Soil Science 168:138-144</p> <p>Himmelbauer, M.L. 2001. Study of root growth in the field. Soil Science, Agro chemistry and Ecology, Vol. 4-6: 179-181</p>
Links	<p>http://www.nstl.gov/software/rootedge.html</p> <p>http://www.regentinstruments.com/</p>
Additional information (see also colour plate on p. 521)	 <p>Figure 1 consists of two panels, (a) and (b), illustrating root profile distribution. Panel (a) is a horizontal bar chart showing dry mass density in mg/cm^3 on the x-axis (ranging from 0.00 to 0.80) against depth in cm on the y-axis (ranging from 2 to 98 cm). The bars show a peak density of approximately 0.65 mg/cm^3 at a depth of 10 cm, with density decreasing as depth increases. Panel (b) is a grid-based index of root distribution, showing the number and size of visible roots per square on a grid. The x-axis represents the grid index (1 to 33) and the y-axis represents depth in cm (6 to 96 cm). The grid shows a dense network of roots, particularly in the upper 30 cm of the soil profile.</p> <p>Fig. 1. Root profile distribution expressed as a) dry mass density and b) index related to the number and size of the visible roots per square (<i>Zea mays</i> L., Sarnevo, Bulgaria, 1993).</p>

ID	12_Hodge
Author	Hodge, Angela Department of Biology, Area 2, PO Box 373, University of York, YORK, YO10 5YW. U.K. ah29@york.ac.uk; +44 1904 328562
Parameter	Root proliferation (and demography) in N-rich organic patches & influence of AM fungi on root proliferation
Soil type	Loamy soil
Plant species	Various grass species, <i>Plantago</i>
System	field soil, microcosms and temporally/spatially heterogeneous substrates (patches)
Method	Microcosms: various designs from essentially 2-D plates to larger containers with minirhizotron tubes
Method description	1. Larger microcosms fitted with minirhizotron tubes and gas sampling tubes (Fig. 2) 2. essentially 2-D systems consisting of two glass plates with thin strips of perspex (Fig. 1).
Do's, don'ts, potential limitations, untested possibilities	Both techniques work well but there is only a limited amount of time you can grow plants in between glass sheets. Watering over the entire surface of the glass plate must be done daily to bring up to gravimetric weight and care must be taken when packing of growth substrate so it stays in situ when placed upright. Does allow precise placement of organic substrates in the system.
References	Hodge, A. 2003. Plant nitrogen capture from organic matter as affected by spatial dispersion, interspecific competition and mycorrhizal colonization. <i>New Phytologist</i> 157: 303-314. Hodge, A. 2001. Arbuscular mycorrhizal fungi influence decomposition of, but not plant nutrient capture from, glycine patches in soil. <i>New Phytologist</i> 151: 725-734. Hodge, A.; Stewart, J.; Robinson, D.; Griffiths, B.S.; Fitter, A.H. 2000. Competition between roots and soil micro-organisms for nutrients from nitrogen-rich patches of varying complexity. <i>Journal of Ecology</i> 88: 150-164. Hodge, A.; Stewart, J.; Robinson, D.; Griffiths, B.S.; Fitter, A.H. 2000. Plant N capture and microfaunal dynamics from decomposing grass and earthworm residues in soil. <i>Soil Biology and Biochemistry</i> 32: 1763-1772. Hodge, A.; Stewart, J.; Robinson, D.; Griffiths, B.S.; Fitter, A.H. 1999. Why plants bother: root proliferation results in increased nitrogen capture from an organic patch when two grasses compete. <i>Plant, Cell and Environment</i> 22: 811-820.

Additional information

Fig. 1. 2-D microcosm for determining root length in organic patches

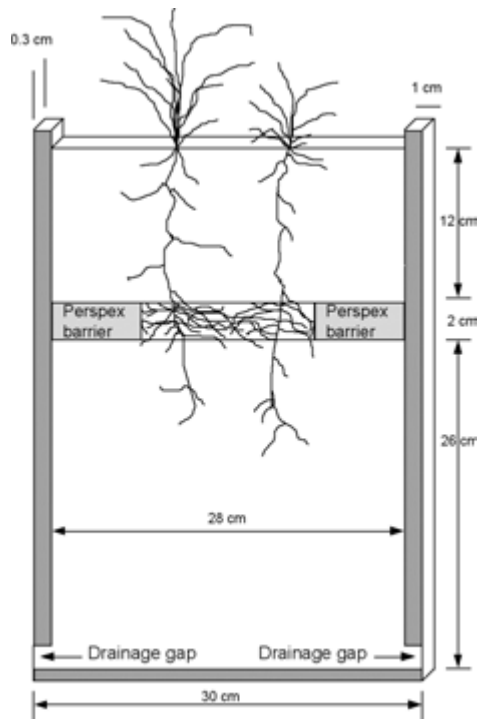
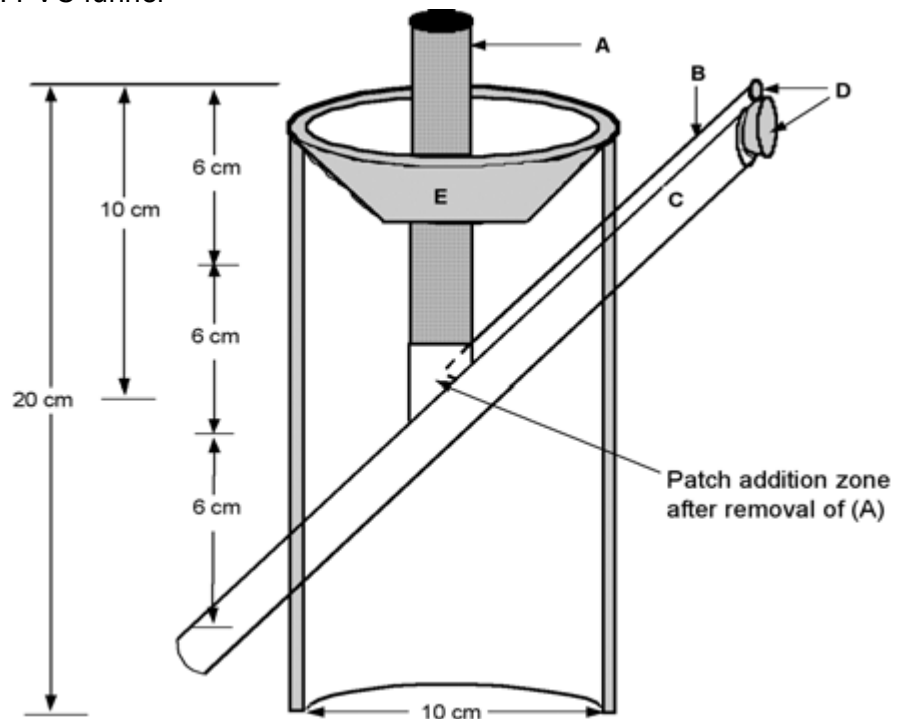

Fig. 2. Larger microcosm unit for root demography studies.

- A: PVC pipe
- B: Gas sampling tube
- C: Minirhizotrone tube
- D: Plugs
- E: PVC funnel



ID	12_Iglesias
Author	Iglesias, M. Isabel; Lamosa, S. Universidad de Santiago de Compostela, Escuela Politécnica Superior, Departamento de Producción Vegetal, Campus Universitario s/n, E- 27002- Lugo beligiaz@lugo.usc.es, +34 982 252231
Parameter	Root length, number of root tips, root diameter
Soil type	Loamless mixes (peat, sand, bark and compost)
Plant species	<i>Quercus robur</i> , <i>Thuja plicata</i> , <i>Cotoneaster horizontalis</i> , <i>Evonymus japonicus</i>
System	Greenhouse trials in modules
Method	Root image analysis by Delta-T SCAN
Method description	The root samples are washed and separated from substrate by hand. The unstained root system is cut in shorter pieces and spread out in glass tray for recording with flatbed scanner from below. The black & white thresholding is used to recognition of plant roots
Do's, don'ts, potential limitations, untested possibilities	<ul style="list-style-type: none"> • A good preparation of the root samples is essential. It can be very time-consuming if root samples are large and branched • It's necessary to set the threshold for each class of root (species). To set the threshold we use an object with known width and length that is scanned with the root sample. • When the root sample is cut in segments (Fig. 1), the number of tips is overestimated. The real number of tips must be estimated from number of first roots, number of segments of roots and tip count. • Important to achieve precision: not overlap individual roots in the scan tray, arrange the root segments randomly to achieve a uniform distribution of orientations of root segments • The staining isn't necessary for coloured roots (tints and shades of brown) where a good contrast with the background can be obtained.
References	<p><i>Description and comparison of different methods of root image analysis, advantage and difficulties of them, references:</i></p> <p>Richner, W.; Liedgens, M.; Bürgi, H.; Soldati, A.; Stamp, P. 2000. Root image analysis and interpretation. In: Smit, A.L.; Liedgens, M.; Bürgi, H.; Soldati, A.; Stamp, P. (eds.) Root methods a Handbook. Springer-Verlag, Berlin, pp. 305-341.</p> <p>Bouma, T.J.; Nielsen, K.L.; Koutstaal, B. 2000. Sample preparation and scanning protocol for computerised analysis of root length and diameter. Plant and Soil 218: 185- 196.</p> <p><i>Description of Delta- T Scan procedure. Example of results with interpretation:</i></p> <p>Kirchhof, G.; Pendar, K. 1993. Delta-T SCAN user manual. Delta –T Devices Ltd., Burwell, Cambridge, UK.</p>
Links	http://www.delta.t.co.uk

Additional information

Fig. 1. The scanned image in black & white of an unstained root sample of *Thuja plicata* 'Atrovirens' cutting.



For more details contact the authors.

1.2. Root Growth and Morphology

Editors: Heljä-Sisko Helmisaari, Ivano Brunner

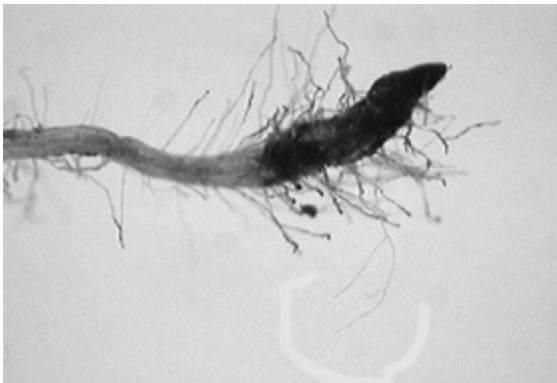
ID	12_Loes
Author	Løes, Anne-Kristin Norwegian Centre for Ecological Farming, N-6630 Tingvoll anne.k.loes@norsok.no; ++47 71 53 20 26
Parameter	Root hair length
Soil type	Agricultural soil
Plant species	Wheat, barley
System	Field
Method	Microscopy and image analysis
Method description	Gently washed cereal roots were immersed in water and examined by microscopy. Root hair length measured by appropriate software on representative parts of the root, 40 measurements per replicate.
Do's, don'ts, potential limitations, untested possibilities	The variation in root hair length in field grown cereals is considerable. Some root hairs were remarkably long, and were rapidly moving the water or alcohol solution (15%, for storage) for a much longer time than the other root hairs when the petri dish was touched. Such „root hairs“ may in fact be fungal hyphae, and care should be taken to avoid misinterpretation.
References	<i>General description of measuring root hair lengths can be found in:</i> Gahoonia, T.S.; Care, D.; Nielsen, N.E. 1997. Root hairs and phosphorus acquisition of wheat and barley cultivars. Plant and Soil 191: 181-188. Gahoonia, T.S.; Nielsen, N.E. 1999 Phosphorus (P) acquisition of cereal cultivars in the field at three levels of P fertilization. Plant and Soil 211: 269-281.
Links	www.norsok.no
Additional information (see also colour plate on p. 522)	<p>The root hair development and – length is very dependent of the growth media. See poster presented on the COST meeting in Vienna, 2002 at www.norsok.no: Løes & Gahoonia: Ranking of wheat genotypes for root hair growth in different growing media.</p> <p>The figure below demonstrates that fungal hyphae may be visible at the magnification that is used for measuring root hair length. The root was stained to study possible infections by mycorrhizal fungi. The thread-like structure below the root tip is branched, whereas root hairs are normally not branched. Hence, this structure is most probably a hyphae.</p> <div style="display: flex; align-items: flex-start;">  <div style="margin-left: 10px;"> <p>It is possible that it is a <i>Rhizoctonia spec.</i>, because this fungus has relatively thick hyphae with a characteristic branching. Some normal root hairs can be seen to the left on the picture, whereas the root hairs close to the tip seem to be damaged (due to fungal infection?) and therefore more heavily stained.</p> </div> </div> <p>Picture: Anne-Kristin Løes.</p>

1.2. Root Growth and Morphology

Editors: Heljä-Sisko Helmisaari, Ivano Brunner

ID	12_Lohmus																																
Author	Lõhmus, K.; Ostonen, I. University of Tartu, Institute of Geography, Vanemuise 46, 51014 Tartu, Estonia; krista.lohmus@ut.ee; ++372 7 375 231																																
Parameter	Fine root biomass, production and turnover rate																																
Soil type	Forest soil																																
Plant species	Trees																																
System	Field and laboratory studies																																
Method	Combined method of ingrowth and soil cores																																
Method description	Fine root turnover rate is calculated as the annual fine root production (from third year ingrowth cores) divided by fine root biomass (estimated from soil cores).																																
Do's, don'ts, potential limitations, untested possibilities	<ul style="list-style-type: none"> • This method could be used for forests in boreal and temperate zones, but it is untested for other species than Norway spruce. • This method is less laborious compared to sequential soil coring. Soil cores for estimating biomass could be sampled once during growing season (time suggested). For third year ingrowth cores at least four samplings are needed to estimate turnover rate. 																																
References	<p>Ostonen, I. 2003. Fine root structure, dynamics and proportion in net primary production of Norway spruce forest ecosystem in relation to site conditions. <i>Dissertationes Biologicae Universitatis Tartuensis</i> 84. Tartu University Press.</p> <p>Ostonen, I.; Lõhmus, K; Pajuste, K. 2005. Fine root biomass, production and its proportion of NPP in a fertile middle-aged Norway spruce forest: comparison of soil core and ingrowth core methods. <i>Forest Ecology and Management</i> 212: 264-277.</p> <p>Makkonen, K.; Helmisaari, H.S. 1999. Assessing Scots pine fine-root biomass comparison of soil core and root ingrowth core methods. <i>Plant Soil</i> 210:43-50.</p> <p>Vogt, K.A.; Persson, H. 1991. Measuring growth and development of roots. In: Lassoie, J.P.; Hinckley, T.M. (eds.) <i>Techniques and Approaches in forest tree ecophysiology</i>. CRC Press, Boca Raton FL: pp. 599ff.</p>																																
Additional information	<p>Fig. 1. The dynamics of fine root biomass (<2 mm) estimated by sequential coring, and fine root annual net primary production (NPP) calculated by the combined method (turn-over rate of 3rd year ingrowth core (yr^{-1}) x fine root biomass measured by sequential cores (t ha^{-1}) = annual NPP ($\text{t ha}^{-1} \text{yr}^{-1}$)). The line denotes fine root annual NPP measured by sequential coring. Letters indicate significant differences between the mean fine root biomasses of different months, bars indicate standard errors (from Ostonen et al., 2005; with permission from Elsevier)</p> <table border="1"> <caption>Data from Figure 1: Fine root biomass and annual NPP (t ha⁻¹)</caption> <thead> <tr> <th>Month</th> <th>Fine root (<2 mm) bio-mass, t ha⁻¹</th> <th>calculated annual NPP, t ha⁻¹ yr⁻¹</th> <th>measured annual NPP, t ha⁻¹ yr⁻¹</th> </tr> </thead> <tbody> <tr> <td>96jun</td> <td>~1.3 (b)</td> <td>~1.8</td> <td>~2.5</td> </tr> <tr> <td>jul</td> <td>~1.6 (b)</td> <td>~2.2</td> <td>~2.5</td> </tr> <tr> <td>aug</td> <td>~1.7 (b)</td> <td>~2.3</td> <td>~2.5</td> </tr> <tr> <td>sept</td> <td>~1.6 (b)</td> <td>~2.3</td> <td>~2.5</td> </tr> <tr> <td>oct</td> <td>~2.0 (b)</td> <td>~2.8</td> <td>~2.5</td> </tr> <tr> <td>nov</td> <td>~0.6 (a)</td> <td>~0.9</td> <td>~2.5</td> </tr> <tr> <td>97jun</td> <td>~1.1 (ab)</td> <td>~1.5</td> <td>~2.5</td> </tr> </tbody> </table>	Month	Fine root (<2 mm) bio-mass, t ha⁻¹	calculated annual NPP, t ha⁻¹ yr⁻¹	measured annual NPP, t ha⁻¹ yr⁻¹	96jun	~1.3 (b)	~1.8	~2.5	jul	~1.6 (b)	~2.2	~2.5	aug	~1.7 (b)	~2.3	~2.5	sept	~1.6 (b)	~2.3	~2.5	oct	~2.0 (b)	~2.8	~2.5	nov	~0.6 (a)	~0.9	~2.5	97jun	~1.1 (ab)	~1.5	~2.5
Month	Fine root (<2 mm) bio-mass, t ha⁻¹	calculated annual NPP, t ha⁻¹ yr⁻¹	measured annual NPP, t ha⁻¹ yr⁻¹																														
96jun	~1.3 (b)	~1.8	~2.5																														
jul	~1.6 (b)	~2.2	~2.5																														
aug	~1.7 (b)	~2.3	~2.5																														
sept	~1.6 (b)	~2.3	~2.5																														
oct	~2.0 (b)	~2.8	~2.5																														
nov	~0.6 (a)	~0.9	~2.5																														
97jun	~1.1 (ab)	~1.5	~2.5																														

ID	12_Mainiero
Author	Mainiero, Raphael University of Ulm, Department Systematic Botany and Ecology (Biology V), Albert Einstein Allee 11, 89081 Ulm, Germany raphael.mainiero@biologie.uni-ulm.de; ++49 731 5022695
Parameter	Fine root dynamics
Soil type	stagnic cambisol
Plant species	<i>Fagus sylvatica</i> L. (European beech)
System	field soil
Method	Minirhizotrone
Method description	Transparent tubes are installed in close contact to the soil and fine roots, growing along the tube surface are observed at regular intervals using different kind of optical systems (e.g. video-camera, digital miniature camera). This method allows to precisely retrieve and track individual fine roots and their development from appearance to death. Image analysis is made on screen mostly with regard to timing and intensity of root formation and/or mortality. Using such observation technique enables to document concurrent root production and die off and thus prevents underestimation of turnover processes (Kurz and Kimmins 1987, Majdi 1996). As this method is non-destructive, it is predominantly appropriate to study root system dynamics (see Mackie-Dawson and Atkinson 1991, Hendrick and Pregitzer 1996 for general descriptions)
Do's, don'ts, potential limitations, untested possibilities	<p><i>Tube material and installation</i></p> <p>Different kind of materials have been used for minirhizotron tubes. Beside practical aspects such as scratch and frost resistance, different materials were shown to influence root survivorship in some plants (Withington et al. 2003). Care should be taken to install the tubes in close contact to the soil and to avoid the creation of voids leading to atypical root growth or branching and condensed water on the tube's surface. The soil interface, however should not get compressed leading to increased mechanical resistance. Therefore, an auger with slightly smaller diameter than the tube's one should be used. We recommend to use a mechanical support when driving in the auger. Successful installation is exacerbated in stony soils. For this purpose inflatable minirhizotrones were developed (Smit et al. 2000, López et al. 1996). In water saturated, dense soils, high water levels can lift the tubes upward so that they should be weighted to prevent any movement.</p> <p>Smit et al. (2000) reviewed the problem of insertion angle. Even though most scientist preferred to install the tubes angled in the soil, mostly 30° or 45°, vertically installed minirhizotrones better matched results obtained by soil coring. Moreover, vertically installed tubes enable imaging in all directions and facilitate the usage of adapters (see below). Minirhizotrones should carefully be protected against light penetration and heat absorption. A coverage of black adhesive foil and white or reflecting aluminum foil is a useful and cheap solution.</p> <p><i>Imaging and root length measurement</i></p> <p>Particularly in forest soils a great heterogeneity of root distribution should be expected that forces to take a high number of replicates. The usage of a rigid borescope with integrated cold light source and an attached digital miniature camera proved to be very useful to get a high number of images in short</p>

	<p>time and with the necessary precession. Retrieving of identical positions is enabled by using an adapter with markings that are superimposed to markings on the tube. Vertical positions are adjusted by markings on the borescope. When using this method it is necessary to choose materials that do not undergo strong diameter changes due to temperature changes and the minirhizotrones borders must be plane.</p> <p>Depending on the optical system used and the tubes curvutare the images obtained can be strongly distorted. If so, images have to be straightened out before measuring root length directly on screen. Programs that are able to straighten out such complex distortion (e.g. ArcInfo) are rather complex and expensive. A simple but precise method is to overlay a distorted grid on the images and to count intersections of roots with it. Such grid can be easily obtained by shooting an image of a scale paper. There is a linear relationship between cascet counts and root length. An analog method (line intersection method) was already described by Tennant (1976) and Upchurch (1987). Minirhizotrone image evaluation is a very time consuming procedure. Therefore it is necessary to optimize time intervals of sampling. The time distances should not be too high in order to prevent underestimation of root production due to roots that appeared and dissapeared during the time intervals (e.g. Tingey et al. 2003). In <i>Fagus sylvatica</i>, both root appearance and mortality are lineary correlated with soil temperature (Mainiero et al. 2004). Thus time intervals between sampling dates should be small in summer (not more than 2 weeks) and can be extended in winter months (ca. 4 weeks).</p>
References	<p><i>Estimating underground production and comparison with other methods</i> Kurz, W.A.; Kimmins, J.P. 1987. Analysis of some sources of error in methods used to determine fine root production in forest ecosystems – a simulation approach. Can. J. For. Res.17: 909-912</p> <p>Majdi, H. 1996. Root sampling methods – Applications and limitations of the minirhizotron technique. Plant Soil 185: 255-258.</p> <p><i>General descriptions</i> Macki-Dawson; Atkinson. 1991. Special Publications of the British Ecological Society. Root growth: 25-47.</p> <p><i>Tube material and installation</i> Withington, J.M.; Elkin, A.D.; Bulaj, B.; Olesinski, J.; Tracy, K.N.; Bouma, T.J.; Oleksyn, J.; Anderson, L.J.; Modrzynski, J.; Reich, P.B.; Eissenstat, d.M. 2003. The impact of material used for minirhizotron tubes for root research. New Phytol. 160: 533-544.</p> <p>Smit et al. 2000. In: Smit et al. (eds.): Root Methods, Springer-Verlag, Berlin: 236-256.</p> <p>López, B.; Sabate, S.; Gracia, C. 1996. An inflatable minirhizotron system for stony soils. Plant Soil 179: 255-260.</p> <p><i>Imaging and root length measurement</i> Tennant, D. 1975. Test of a modified line intersect method of estimating root length. J. Ecol.: 995-1001.</p> <p>Upchurch. 1987. Special Publication American Society of Agronomy, Madison, WI; ASA. 50: 51-65.</p> <p>Tingey, D.T.; Phillips, D.L.; Johnson, M.G. 2003. Optimizing minirhizotron sample frequency for an evergreen and deciduous tree species. New Phytol. 157: 155-161.</p> <p>Mainiero et al., 2004. Freiburger Forstliche Forschung Berichte 57: 51.</p>

ID	12_Makkonen
Author	Makkonen, Kirsi; Helmisaari, Heljä-Sisko Finnish Forest Research Institute, Vantaa Research Centre, P.O.Box 18, FI-01301 Vantaa, Finland kirsi.makkonen@metla.fi; ++358 10 211 2663
Parameter	Root biomass and necromass
Soil type	Upland forest soil
Plant species	Scots pine (<i>Pinus sylvestris</i>), Norway Spruce (<i>Picea abies</i>), Birch (<i>Betula</i> sp.), understorey species groups (shrubs, grasses, herbs)
System	field and laboratory studies
Method	Soil core method
Method description	Soil core (using core diameters 3.6 to 5 cm) samples are taken from the organic layer and underlying mineral soil (organic layer and down to 40 cm mineral soil, even deeper with a special corer) and divided into different soil layers by depth. Samples are transported from the field to the laboratory and stored frozen until analysis. In the laboratory, roots are carefully manually washed free of soil on sieves, and further classified using microscopes into tree species or understorey vegetation species groups and according to diameter (usually <1 mm, 1-2 mm, 2-5 mm, but also <0.5 mm, 0.5-1 mm etc.) and physiological status (live or dead). Living roots of different species are distinguished on the basis of their mycorrhizas, colour and morphology. Dead roots can be distinguished from living roots on the basis of their colour and consistency. Samples are then dried (48 h, 70°C) and dry mass weighed.
Do's, don'ts, potential limitations, untested possibilities	Soil coring suits best for stoneless or less stony sites.
References	Makkonen, K.; Helmisaari, H.-S. 1999. Assessing fine-root biomass and production in a Scots pine stand – comparison of soil core and root ingrowth core methods. <i>Plant Soil</i> 210:43-50. Vogt, K.A.; Persson, H. 1991. Measuring growth and development of roots. In Lassoie J.P. and Thomas, M.H. (eds.) <i>Techniques and approaches in forest tree ecophysiology</i> . CrC Press. Boca Raton, FL. Pp 477-501.

ID	12_Menon
Author	Menon, Manoj ¹⁾ ; Oswald, Sascha ¹⁾ ; Lehmann, Eberhard ²⁾ ¹⁾ Institute of Terrestrial Ecology, Swiss Federal Institute of Technology, Zurich, Switzerland; menoneth@gmail.com; ++41 44 633 6078 ²⁾ Paul Scherrer Institute, Villigen, Switzerland ++41 56 310 29 63; eberhard.lehmann@psi.ch
Parameter	<i>In situ</i> root growth, dynamic water uptake, infiltration
Soil type	Quartz sand, soils
Plant species	Suited for small/herbaceous plants
System	Flat aluminium containers (2D) or cylinders (3D)
Method	Neutron Radiography
Method description	<i>Preparation of media:</i> Flat aluminium containers or cylinders filled with quartz sand or soil plants are grown in situ. <i>Imaging:</i> Plants are radiographed/tomographed in neutron beam. Plants are illuminated during the imaging. The resolution range is 0.13-0.27 mm in the digital images, depending on the camera position. An exposure time of 10-20s per image was given to minimise the damage to the living tissues. Water infiltration and dynamic water uptake can be studied using automatic and fast imaging procedure (e.g., every minute). <i>Image analysis:</i> Images can be processed using any standard software (IDL, Matlab, ImagePro, ImageJ (free software) etc. Movies can be produced for better visualisation of dynamic phenomena.
Do's, don'ts, potential limitations, untested possibilities	<i>Do's</i> Plan the experiment according to the available dates of the facility. In order to get good quality pictures, irrigation should be done 1-2 days before the imaging. Maintain the position of Al-containers in each imaging days and use markers (Gd). <i>Don'ts:</i> Avoid over exposure to neutrons (exposure time calculations are made with the help of experts of the facility) <i>Limitations:</i> Availability of the facility, limited size of the containers <i>Possibilities:</i> Effect of biotic and abiotic factors on root growth can be studied.
Links	http://neutra.web.psi.ch/

Additional
information

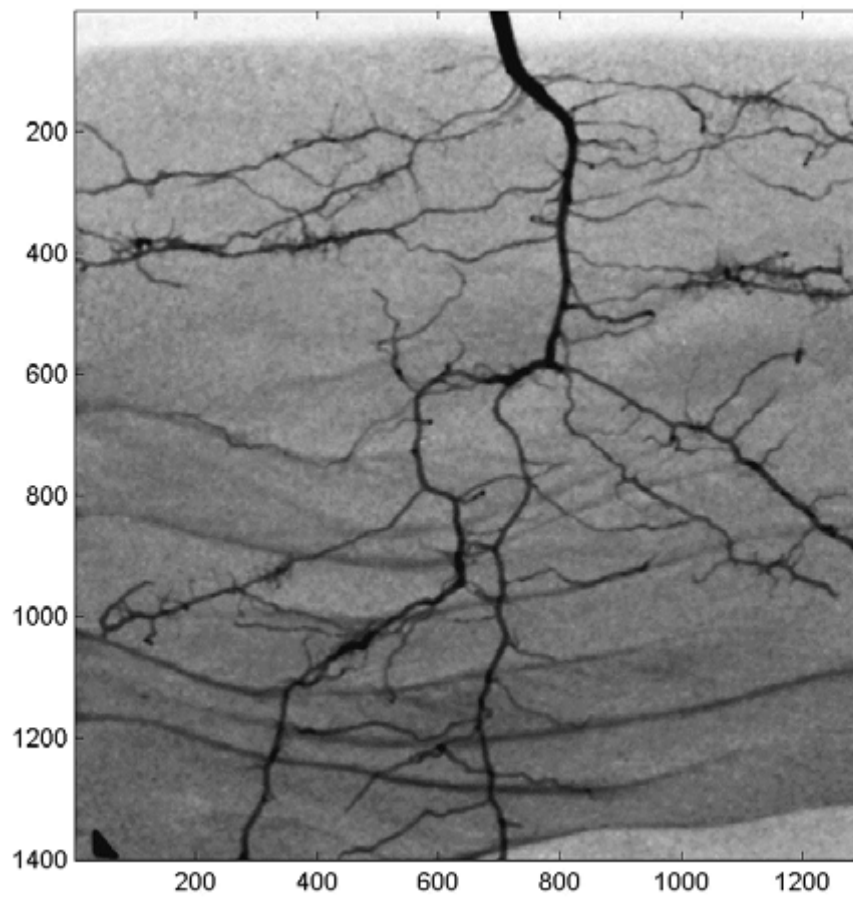
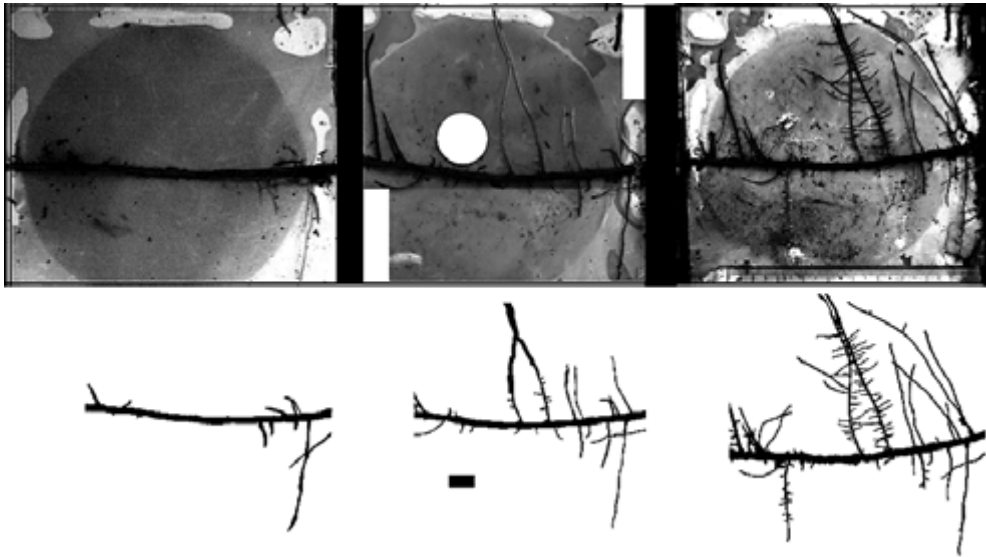

Fig. 1. Neutron radiograph of 4 week old lupin root system (media: quartz sand). Layers in the porous medium are due to filling of sand in the container, which trapped moisture and how roots respond to such local heterogeneity. Gadolinium marker can be seen in the left corner

1.2. Root Growth and Morphology

Editors: Heljä-Sisko Helmisaari, Ivano Brunner

ID	12_Nikolova
Author	Nikolova, P.; Blaschke, H.; Matyssek, R. Technische Universität München, Center of Life and Food Sciences, Department of Ecology, Ecophysiology of Plants, Am Hochanger 13, 85354 Freising, GERMANY blaschke@bot.forst.tu-muenchen.de; +49-08161-71-4582 nikolova@bot.forst.tu-muenchen.de, nikolova@uni-landau.de
Parameter	Fine root growth dynamics: root production, root mortality. Morphological parameters: fine-root length, diameter, surface area, fine-root phenology and ontogeny.
Soil type	Forest soil, organic litter layer
Plant species	Conifers and hardwoods
System	Slim case rhizotron
Method	Digital <i>in situ</i> recording of fine-root architecture and growth dynamics
Method description	<p>This new inexpensive and uncomplicated rhizotron approach was developed to analyse <i>in situ</i> (i.e. in the fermentation layer of forest soils) seasonal dynamics of fine-root growth and root morphological parameters. It is based on periodical digital recording and image analysis of intact fine rootlets (diameter < 2mm) of woody species.</p> <p>The approach makes use of transparent super slim cases (TSSC) commercially available for covering CD's or DVD's. Plastic TSSC were modified for clamping individual laterals of fine-roots growing horizontal to the soil surface. A circular opening (diameter 11.5 cm) was cut out on both sides of the TSSC. Openings were covered on the inner side with a polyester (PET) net (mesh size 40 µm or 80 µm) which prevented contamination of rootlet surface with organic soil particles, and in same time permitted gas diffusion and access to as well as drainage of soil water.</p> <p>The rhizotrons were placed horizontally in the fermentation layer, and the growing apical portions of fine-roots mounted per one TSSC through a notch in the slim case wall. The notch has to be larger than the root diameter to allow for radial growth. While the lower shell of the TSSC stays untouched, the upper shell can be opened at intervals during the growing season for studying <i>in situ</i> root growth patterns and ectomycorrhiza formation (see Blaschke et al., this volume). When closing again, the upper lid of the TSSC needs to be covered with a layer of litter or moss from the site to prevent desiccation of roots.</p> <p>Observation and recording equipment requires a digital camera system (KAPPA DX-30) with zoom, including the KAPPA® Image Base Control Software (KAPPA opto-electronics GmbH, Gleichen, Germany).</p> <p>Fine-root architecture (total root length, number of tips, mean diameter, branching, root surface area) was analysed after converting images into grey levels with WinRHIZO® Pro, version 2003 (Regent instruments, Canada; see the figure below).</p> <p>Studies on root phenology and ontogeny can be followed, in this way, with the same intact fine-root system, avoiding destructive sampling throughout several months to years.</p>

Do's, don'ts, potential limitations, untested possibilities	<ul style="list-style-type: none"> • Time intervals of recording 4 to 6 weeks (depending on root activities) to minimise disturbance of ectomycorrhizal development. • Life span, fine-root turnover (decomposition), fine-root regeneration can be calculated in addition. Observation of fine-root branching (topology) and space exploitation strategy is possible as well (see 41_Blaschke). 																
References	<p>Regent Instrument Manual WinRHIZO. 2003. Basic, Reg & Pro, For washed root measurements; Regent Instruments Inc., Quebec, Canada.</p> <p>Pregitzer, K.S.; De Forest, J.L.; Burton, A.J.; Allen, M.F.; Ruess, R.W.; Hendrick, R.L. 2002. Fine root architecture of nine north american trees. <i>Ecological Monographs</i> 72: 293-309</p> <p>Pregitzer, K.S. 2002. Fine roots of trees - a new perspective. <i>New Phytologist</i> 154: 267-273.</p>																
Links	<p>http://www.forst.uni-muenchen.de/EXT/LST/BOTAN/INSTITUT/nikolova02.html</p> <p>http://www.regentinstruments.com/</p>																
Additional information	<div style="display: flex; justify-content: space-around; text-align: center;"> June August October </div>  <p style="text-align: center;">Bar represents 10 mm length and 5 mm width.</p> <p>Fig. 1. Example of the seasonal dynamics of fine-root growth of spruce (timing of root elongation intensity), and the ontogenetic development of root structures during vegetation period of 2002. Total root length, root surface area and average root diameter were analysed with WinRHIZO® (see table below).</p> <table border="1" data-bbox="387 1615 1370 1783"> <thead> <tr> <th>Parameter</th> <th>June</th> <th>August</th> <th>October</th> </tr> </thead> <tbody> <tr> <td>Root length (mm)</td> <td>237</td> <td>426</td> <td>1122</td> </tr> <tr> <td>Surface area (mm²)</td> <td>1272</td> <td>1497</td> <td>3626</td> </tr> <tr> <td>Average diameter (mm)</td> <td>1.78</td> <td>1.17</td> <td>1.08</td> </tr> </tbody> </table>	Parameter	June	August	October	Root length (mm)	237	426	1122	Surface area (mm ²)	1272	1497	3626	Average diameter (mm)	1.78	1.17	1.08
Parameter	June	August	October														
Root length (mm)	237	426	1122														
Surface area (mm ²)	1272	1497	3626														
Average diameter (mm)	1.78	1.17	1.08														

ID	12_Ostonen
Author	Ostonen, I.; Lõhmus, K. University of Tartu, Institute of Geography, Vanemuise 46, 51014 Tartu, Estonia; ivika.ostonen@ut.ee; ++372 7 375 231
Parameter	Specific root area (SRA), root tissue density (RTD), specific root length (SRL) and specific endoderm area (SEA); dimensions and proportions of mantle, cortex and stele of ectomycorrhizas
Soil type	Forest soil
Plant species	ectomycorrhizal tree species
System	field and laboratory studies
Method	Phytoprocentric approach of morphological and anatomical fine root parameters
Method description	The clean short root tips with primary structure of trees should be prepared for detecting fine root parameters. For anatomical study thin transverse or axial sections of short roots are cut using the freezing microtome cryostat, all sections are coloured (e. g. methylene-blue) and dimensions of different tissues are measured under a light microscope. The proportions of different tissues on cross section area of root are calculated. For morphological study the clean root samples are scanned (e. g. WinRHIZO could be used) to determine mean surface area, length, diameter and volume of roots and weighted; the root tips are counted. The derived functional characteristics: RTD, SRA, SRL and SEA can be calculated from direct measurements of fine roots (see References).
Do's, don'ts, potential limitations, untested possibilities	Derived functional characteristics reflect site quality for a tree species. SRA, RTD, SRL could be used for roots of all plant species, SEA could be used for roots with primary structure. Untested for other species than Norway spruce, Scots pine and grey alder.
References	Lõhmus, K.; Oja, T.; Lasn, R. 1989. Specific root area : A soil characteristic. <i>Plant Soil</i> 119: 245–249. Ostonen, I.; Lõhmus, K.; Lasn, R. 1999. The role of soil conditions in fine root ecomorphology in Norway spruce (<i>Picea abies</i> (L.) Karst.). <i>Plant Soil</i> 208: 283-292. Ostonen, I., Lõhmus, K. 2003. Proportion of fungal mantle, cortex and stele of ectomycorrhizas in <i>Picea abies</i> (L.) Karst. in different soils and site conditions. <i>Plant Soil</i> 257: 435-442. Eissenstat, D.M.; Achor, D.S. 1999. Anatomical characteristics of roots of citrus rootstocks that vary in specific root length. <i>New Phytol.</i> 141: 309-321. Pregitzer, K.S.; DeForest, J.L.; Burton, A.J.; Allen, M.F.; Ruess, R.W.; Hendrick, R.L. 2002. Fine root architecture of nine North American trees. <i>Ecological Monographs</i> 72: 293-309.
Links	http://www.regent.qc.ca

ID	12_Sainz_a
Author	Sainz, María J. Departamento de Producción Vegetal, Universidad de Santiago de Compostela, Campus Universitario s/n, E-27002 Lugo, Spain mjsainz@lugo.usc.es; + +34 982 252231
Parameter	Root biomass
Soil type	any
Plant species	any
System	Pots, auger and ingrowth field root samples
Method	Measurement of root weight
Method description	Root biomass is sometimes estimated from fresh roots but usually from oven-dried roots. In both cases, roots are gently washed free of soil under running water over a sieve. Root fresh weight can be determined after carefully removing water adhering to the roots. Root dry weight is measured after drying roots at 70° during 48 h.
Do's, don'ts, potential limitations, untested possibilities	<ul style="list-style-type: none"> • Roots should be processed immediately, otherwise they may be stored in polyethylene bags at 4 °C. • It is important to select the sieve size according to the type of root material in order to minimise fine root loss during washing. • If soil particles remain adhered to roots (as happens when taken from soils with a high clay content), some form of sodium metaphosphate can be used to disperse the soil particles. • Do not use a strong flow of water for washing, since roots can be easily damaged.
References	Oliveira, M.R.G.; Van Noordwijk, M.; Gaze, S.R.; Brouwer, G.; Bona, S.; Mosca, G.; Hairiah, K. 2000. Auger sampling, ingrowth cores and pinboard methods. In: Smit, A.L. et al. (eds.) Root Methods: A Handbook. Springer-Verlag, Berlin, pp. 175-210.

ID	12_Sainz_b
Author	Sainz, María J. Departamento de Producción Vegetal, Universidad de Santiago de Compostela, Campus Universitario s/n, E-27002 Lugo, Spain mjsainz@lugo.usc.es; ++34 982 252231
Parameter	Root architecture
Soil type	Any
Plant species	Any
System	Pots, field soil cores
Method	Image analysis
Method description	Record the volume of pots or core samples. Carefully separate roots from soil by washing, trying to avoid fine root loss. The clean root system is cut in smaller pieces, suspended in a thin layer of water, and evenly spread on a transparent glass tray, which is placed on a flatbed scanner to obtain grayscale images. The scanned root images are analyzed to determine length, average diameter or thickness, surface area and volume of roots using specific image analysis software (Delta-T SCAN and WinRHIZO are most frequently used).
Do's, don'ts, potential limitations, untested possibilities	<ul style="list-style-type: none"> • Image analysis is faster, less laborious and more accurate than manual methods. • Most losses during washing are fine roots, which may result in a major loss of root length. • Roots should be spread out on the tray as randomly as possible, trying that individual roots do not overlap. Spreading can be very time-consuming for large and highly branched roots. • Thresholding of root images must be carefully selected for each type of root material. • To enhance the contrast of white unstained roots, a dark background should be chosen. Staining of roots can increase contrast of the sample. • In field soil cores, sample size is determined by the auger.
References	<p>Kirchhof, G; Pendar, K. 1993. Delta-T Scan User Manual. Delta-T Devices Ltd., Cambridge, England.</p> <p>Richner, W.; Liedgens, M.; Bürgi, H.; Soldati, A.; Stamp, P. 2000. Root image analysis and interpretation. In: Smit, A.L. et al. (eds.) Root Methods: A Handbook. Springer-Verlag, Berlin, pp. 305-341.</p> <p>Bouma, T.J.; Nielsen, K.L.; Koutstaal, B. 2000. Sample preparation and scanning protocol for computerised analysis of root length and diameter. Plant and Soil 218: 185-196.</p> <p>Zobel, R. 2003. Sensitivity analysis of computer-based diameter measurement from digital images. Crop Science 43: 583-591.</p>
Links	http://www.delta.t.co.uk http://www.regent.qc.ca

ID	12_Segal
Author	Segal, Eran ¹⁾ ; Shani, Uri ¹⁾ ; Kushnir, Tammi ²⁾ ¹⁾ Department of Soil & Water Sciences, Hebrew University of Jerusalem, Rehovot 76100, Israel; segale@agri.huji.ac.il; 972-8-9489168 ²⁾ Diagnostic Imaging Dept., MRI Institute, The Chaim Sheba Medical Center, Tel Hashomer, Israel.
Parameter	Soil volumetric water content and Root morphology
Soil type	Sandy soils
Plant species	Model plants: barley, melon, cucumber
System	Pots
Method	Magnetic Resonance Imaging (MRI) - Proton density of hydrogen nuclei
Method description	Noninvasive imaging of single root and the surrounding soil water. Seedlings were grown in small pots (50-100 cm ³) in sandy soils. Imaging was performed at different times along the transpiration cycle and several irrigation regimes. At each sampling, water profiles were established along and perpendicular to the root. Soil water content was quantitated by using soil calibration samples of known water content, attached to the Area Of Interest.
Do's, don'ts, potential limitations, untested possibilities	<i>Do's:</i> <ul style="list-style-type: none"> • Long TRs (above 2000ms) to avoid T1 relaxation time dependence (due to changes in water content) of the signal intensity and thus incorrect evaluation of spatial and temporal water content profiles. • Protocols were optimized to minimize susceptibility artifacts induced by small air volumes at dry soil. Short TE (about 12ms), wide bandwidth (15-125 KHz) and 4-8 returns were used for highest S/N ratio. <i>Don'ts:</i> <ul style="list-style-type: none"> • Use soil or solution containing Iron (changes the resonance frequency, and induces susceptibility artifacts). • Image roots at water content close to saturation. <i>Limitations:</i> <ul style="list-style-type: none"> • Analysis of water content in fine texture soils is problematic because of small pores, resulting in low S/N ratio. • Small sample is needed – increased resolution. • Lowest measurable volumetric water content was about 5%.
References	Kushnir, T.; Segal, E.; Yitschak, Y.; Shani, U. 2003. MRI Study of Root Hair Dynamics and Micro Scale Water Uptake Patterns. Proc. ISMRM 11th Ann. Sci. Mtg, Toronto, Canada, July 2003, p. 882 MacFall, J. S.; Johnson, G. H. 1994. Use of magnetic resonance imaging in study of plants and soil. In : Anderson, S.H. ; Hopmans, J.W. (Eds.) Tomography of Soil-Water- Root Processes, SSSA special publication no. 36, pp. 99-112. MacFall, J. S.; Johnson, G. H.; Kramer, P. J. 1990. Observation of a water depletion region surrounding loblolly pine roots by magnetic resonance Imaging. Proc. Natl. Acad. Sci. USA. Vol. 87, pp.1203-1207.

Additional
information

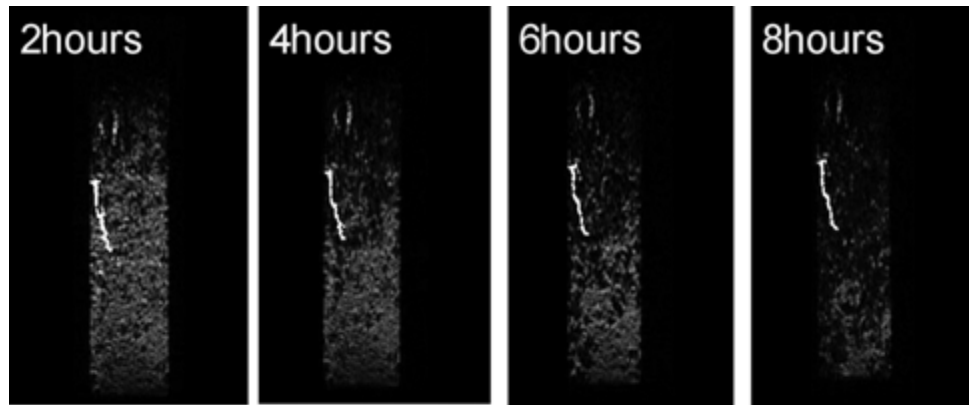

Fig. 1. MRI images of root and water content changes due to drainage & transpiration processes in sandy soil.

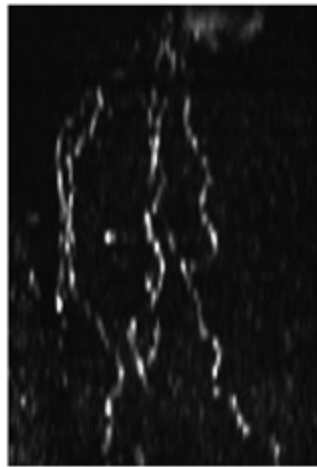

Fig. 2. 3D SPGR MRI
image of root morphology.

ID	12_Thorup_Kristensen
Author	Thorup-Kristensen, Kristian Danish Institute of Agricultural Sciences, Dept. Horticulture ktk@agrsci.dk; ++45 8999 3228
Parameter	Root density and rooting depth, root turnover, short term root growth responses
Soil type	In principle all soil types, but water logged or very stony soils are very difficult or impossible to work in
Plant species	Any
System	Field or lysimeter
Method	Minirhizotron
Method description	<p><i>Observation tubes:</i> Transparent tubes of (glass or other) are inserted into the soil. The tubes are of 4 to 8 cm diameter and inserted at an angle from vertical, typically 30° or 45° to avoid that roots just grow along the tube surface. The roots growing onto the outer surface of the rhizotron are observed by lowering a recording device, typically a mini video camera, into the tube. Only roots on the “upper side” of the sloping rhizotrons should be measured. Normally a grid is painted on the rhizotron surface to allow quantification of roots at different positions in the soil.</p> <p>The equipment for drilling the holes in the soil for minirhizotron insertion is often the most expensive part of the equipment.</p> <p><i>Root quantification:</i> Root density can then be quantified by counting the number of roots crossing the grid lines. Also simpler recordings of roots can be made to describe root system distribution or rooting depth.</p> <p><i>Root growth and turnover:</i> More detailed studies of the root system can be made. By comparing recordings made at different times, growth rates or turnover rates can be estimated by comparing the roots from different dates. Image analysis for quantifying the recorded roots have also been tried, but this is very difficult.</p>
Do's, don'ts, potential limitations, untested possibilities	<p><i>Problems in uppermost soil layers:</i> For various reasons, the minirhizotron method do not always give good data for root growth in the uppermost soil layers. This limits its use for studies of root growth of very young crops, or studies where roots in the uppermost soil layers are critical.</p> <p><i>Roots stay visible on the rhizotron:</i> Roots that have grown onto the rhizotron surface may be very slow to disappear again, even after the plants are dead. This can cause trouble when leaving the tubes in the soil for measuring on subsequent crops, we normally take up the rhizotrons and re-insert them to avoid this problem.</p> <p><i>Short term measurements of root dynamics:</i> Short term measurements of root dynamics have been tested to a limited extent, but the potential in such studies are substantial.</p> <p><i>Combinations with soil analysis:</i> Methods where minirhizotrons are developed to allow chemical analysis of the soil or soil solution outside the rhizotrons could offer important possibilities for</p>

	developing our understanding of root response to soil conditions and on root effects on soil chemistry or biology.
References	<p><i>Relationship between various minirhizotron measurements and crop N uptake:</i> Thorup-Kristensen, K. 2001. Are differences in root growth of nitrogen catch crops important for their ability to reduce soil nitrate-N content, and how can this be measured? <i>Plant and Soil</i> 230: 185-195</p> <p><i>Short term root response to environmental factors:</i> Engels, C.; Mollenkopf, M.; Marschner, H. 1994. Effect of drying and rewetting the topsoil on growth of maize and rape in different soil depths. <i>Z. Pflanzenernähr. Bodenk.</i> 157: 139-144</p> <p><i>Short term quantification of root growth and activity in different parts of the root system:</i> Thorup-Kristensen, K.; Van den Boogaard, R. 1999. Vertical and horizontal development of the root system of carrots following green manure. <i>Plant and Soil</i> 212: 145-153</p> <p><i>Relationship between minirhizotron root recordings and ¹⁵N uptake from different soil depths:</i> Kristensen, H.L.; Thorup-Kristensen, K. 2004. Uptake and ¹⁵N labeled nitrate by root systems of sweet corn, carrot and white cabbage from 0.2-2.5 meters depth. <i>Plant and Soil</i> 265: 93-100</p>

ID	13_Berge
Author	Berge, O.; Brandelet, G.; Heulin, T. CEA/Cadarache, DSV-DEVM-LEMIR Laboratoire d'Ecologie Microbienne de la Rhizosphère, UMR 6191 CNRS-CEA Univ. mediterrane, F-13108 Saint-Paul-Lez-Durance, France. oberge@cea.fr; ++33 442 257 863
Parameter	Ratio of root-adhering soil (RAS) to root tissue (RT) dry masses (RAS/RT ratio), i.e. rhizosphere soil aggregation
Soil type	Any
Plant species	Any
System	microcosm or field soil
Method	Shaking and washing of root systems
Method description	<p><i>Rationale</i> It is postulated that root adhering soil is better for plant nutrient uptake and soil stability. This method to quantify root adhering-soil is especially relevant when used to compare between at least two treatments, for example inoculated vs. non-inoculated plants with an exopolysaccharide-producing bacteria.</p> <p><i>Plant growth</i> For pot experiments, soil is sieved (< 2 or 4 mm) and its moisture adjusts to approximately 80 % of water-holding capacity before sowing. The soil water content of each pot is adjusted daily with water during plant growth.</p> <p><i>Determination of RAS and RT</i> Plant watering is stopped 24 h before harvesting to facilitate the separation of RAS from bulk soil. Roots with adhering soil are carefully separated from bulk soil by hand gentle agitation or by mechanical shaking (Agitest, Stuart scientific during 1 min). RAS is removed from RT by washing them in water. RAS and RT dry masses are measured after 48h at 60°C and RAS/RT ratio calculated.</p>
Do's, don'ts, potential limitations, untested possibilities	<ul style="list-style-type: none"> • The RAS/RT ratio depends on the experimental conditions and variables, because it depends on many factors, mainly plant type and growth stage, soil type and moisture content, photosynthesis and harvest conditions. These factors have to be well controlled and preliminary experiments must be conducted to determine the optimal conditions to measure the ratios with the lowest variability and estimate the necessary number of replicates (usually between 10 and 30 plants). • RAS as well as physical and microbial properties could be measured together with quantification by adapted methods.
References	<p><i>First description of the method:</i> Gouzou, L.; Burtin, G.; Philippy, R.; Bartoli, F.; Heulin, T. 1993. Effect of inoculation with <i>Bacillus polymyxa</i> on soil aggregation in the wheat rhizosphere : preliminary examination. <i>Geoderma</i> 56 : 479-490.</p> <p><i>Comparison of bacterial strain and its non-producing mutant:</i> Bezzate, S.; Aymerich, S.; Chambert, R.; Czarnes, S.; Berge, O.; Heulin, T. 2000. Disruption of the <i>Paenibacillus polymyxa</i> levansucrase gene impairs ability to aggregate soil in the wheat rhizosphere. <i>Environ. Microbiol.</i> 2 (3) : 333-342.</p>

Link between rhizosphere soil aggregation and plant growth promotion:
 Alami, Y.; Achouak, W.; Marol, C.; Heulin, T. 2000. Rhizosphere soil aggregation and plant growth promotion of sunflowers by an exopolysaccharide-producing *Rhizobium* sp. Strain isolated from sunflower roots. *Appl. Environ. Microbiol.* 66 (8) : 3393-3398.

Additional information

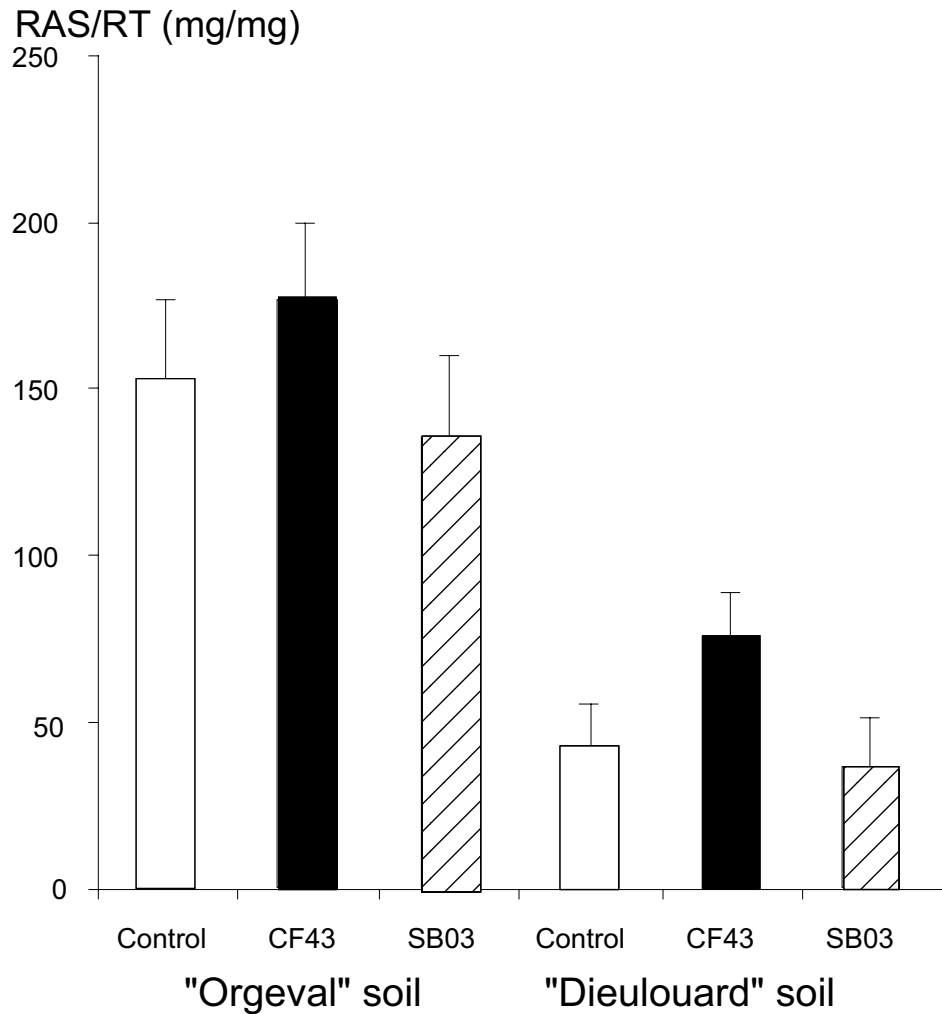
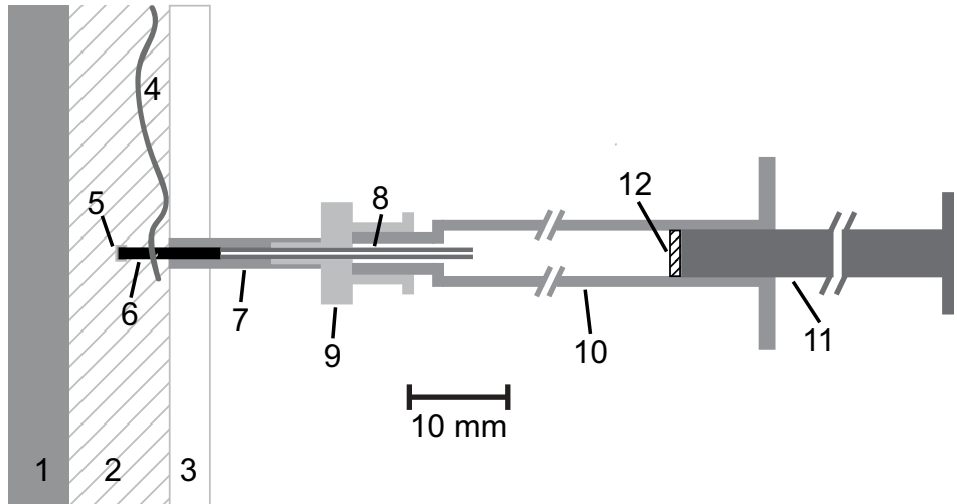

Fig. 1. *Effect of wheat inoculation with P. polymyxa strains.* CF43 is wild type levan producer (EPS +) and SB03 its mutant whose sacB gene encoding levansucrase is disrupted (EPS -). Levan is a fructosyl polymer. Pot experiment was carried out with two french cultivated soils: Orgeval soil, 6% sand, 76% silt, 15% clay, pH 6.6 and Dieulouard soil, 36% sand, 48% silt, 12% clay, pH 5.6. Before utilisation, soil samples were air-dried, sieved to 4 mm, and sterilized by gamma radiation. RAS/RT ratios are represented by bars derived from the means of n = 14 to 24 replicates depending on treatments. Error bars show confidence intervals (P = 0.05). (from Bezzate et al. 2000; with permission of Blackwell Publishing)

ID	13_Dessureault_Rompre
Author	¹⁾ Dessureault-Rompré, Jacynthe; ³⁾ Nowack, Bernd; ¹⁾ Schulin, Rainer; ²⁾ Luster, Jörg ¹⁾ Institute of Terrestrial Ecosystems, ETH Zurich, Universitätstrasse 16, 8092 Zürich, Switzerland ²⁾ Swiss Federal Institute for Forest, Snow, and Landscape Research, WSL, CH-8903 Birmensdorf, Switzerland; joerg.luster@wsl.ch; ++41 44 739 22 95 ³⁾ EMPA – Materials Science and Technology, Lerchenfeldstrasse 5, CH-9014 St. Gallen, Switzerland; nowack@empa.ch; ++41 71 274 76 92
Parameter	collection of rhizosphere soil solution for organic acid analysis
Soil type	Agricultural topsoil
Plant species	White lupine (<i>Lupinus albus</i>)
System	Rhizobox
Method	micro tension lysimeters
Method description	<p><i>Rhizobox setup:</i> Hohenheim-type rhizobox as described by Dieffenbach et al. (1997) but with larger dimensions (length 60 cm, width 15 cm). Air dried and sieved (2 mm) soil (pH 6.4 (0.01 M CaCl₂), 15.1 g/kg C_{org}, 36% sand, 49% silt, 15% clay) filled in at a bulk density of about 1.2 g/cm³. One <i>Lupinus albus</i> seedling (seeds pretreated with 10% hydrogen peroxide and germinated in black garden soil) was planted per box. The boxes were irrigated with synthetic rain water at a water potential of –40 hPa using wicks made from a polymeric tube (Rhizon irrigators, Rhizosphere research products, Netherlands) and installed at 5, 30 and 55 cm soil depth.</p> <p><i>Collection of rhizosphere soil solution:</i> In contrast to Dieffenbach et al. (1997) samples were taken through the transparent front plate of the rhizoboxes. Ceramic capillaries (pure aluminium oxide produced by PI ceramic, D-07589 Lederhose) were used as micro suction cup materials (Göttlein et al., 1996). One millilitre syringes (Norm-Ject, Henke Sass Wolf) connected to the micro suction cups with a dead volume of 4 µl were used to collect the soil solution. For construction details see Figure 1. Before the installation, the micro suction cups were sterilized with ethanol followed by conditioning with autoclaved soil water extract. In addition, 20 µL of formaldehyde solution (> 36.5% (T) in water (Fluka)) were added to each syringe before the sampling to prevent microbial modification of the collected samples. Vacuum was applied once by pulling the piston of the syringe to its end position. With the type of syringe used, the piston remained at this position for the whole sampling period without or little fixing using adhesive tape.</p> <p><i>Chemical analyses:</i> The samples were analyzed for low molecular weight organic acids and inorganic anions using ion chromatography (Dionex autosampler system, AS 50 column, eluent generator: potassium hydroxide (1 to 60 mM), flow: 1.5 ml min⁻¹) with 200 µL insert glass vials to reduce the sample volume. The pH was measured by an ion sensitive field effect transistor electrode (ISFET sensor, Sentron, The Netherlands).</p>
Do's, don'ts, potential limitations,	<ul style="list-style-type: none"> • Installation of the cups through the transparent front plate assures that the "active length" of the micro suction cup of 5 mm is near the root of interest. To optimise the precise positioning of the suction cups, holes were drilled

<p>untested possibilities</p>	<p>through the front plate at a given location well defined in terms of distance to a root just before insertion of the cups by using a hand drill.</p> <ul style="list-style-type: none"> • Sampling should be not more than once per day for 8 hours. The sampling-free time of 16 hours accounts for the need of the soil to reequilibrate (Vetterlein and Jahn, 2004). • The immediate stabilisation of the samples with formaldehyde minimises the risk for microbial degradation. 13_Thiele demonstrate permeability of ceramic suction cup materials for microorganisms while adsorption of organic acids is negligible. • With our modified rhizobox micro suction cup system we were able to detect in-situ organic acids exuded from cluster roots of <i>Lupinus albus</i> and to follow temporally an exudation process and its effect on soil solution chemistry. With this system we could also detect differences between bulk soil, rhizosphere of cluster roots and rhizosphere of other roots (e.g. nodules). • In general we think that this system can be easily adapted to other plant / soil systems. There are, however, some limitations. In sandy soils it is difficult to achieve good hydraulic contact between the soil and the samplers. The sampling strategy has to be adapted to the root system in terms of density, growth pattern and rate.
<p>References</p>	<p><i>Original system:</i> Dieffenbach, A; Göttlein, A; Matzner, E. 1997. In-situ soil solution chemistry in an acid forest soil as influenced by growing roots of Norway spruce (<i>Picea abies</i> [L.] Karst.). Plant and Soil 192: 57-61.</p> <p><i>Detailed description of this system and application to in-situ root exudation by Lupinus albus:</i> Dessureault-Rompré, J.; Nowack, B.; Schulin, R.; Luster, J. 2006. Modified micro suction cup/ rhizobox approach for the in-situ detection of organic acids in rhizosphere soil solution. Plant and Soil 286: 99-107..</p>
<p>Links</p>	<p><i>producer of ceramic capillaries:</i> www.piceramic.de</p>
<p>Additional Information</p>	 <p>Fig. 1. Scheme of the soil solution sampling: 1) back of rhizobox, 2) soil, 3) transparent front plate, 4) root, 5) hot glue, 6) ceramic capillary, 7) outer tubing, 8) insert tubing, 9) female luer connector, 10) 1 ml syringe, 11) piston in open position to produce vacuum, 12) formaldehyde (from Dessureault-Rompré et al., 2006; with kind permission of Springer Science and Business Media).</p>

ID	13_Eldhuset_a
Author	Eldhuset, Toril D. Norwegian Forest and Landscape Institute, P.O. Box 115, N-1431 Ås, Norway toril.eldhuset@skogoglandskap.no; ++47 64 94 80 00
Parameter	Rhizosphere soil solution
Soil type	Acid forest soil (glaciofluvial sandy sediments with 73-86% sand and 12-22% silt).
Plant species	Norway spruce (<i>Picea abies</i>)
System	Root window in the field; rhizobox in the lab
Method	Sampling of soil solution with micro suction cups
Method description	Rhizosphere and bulk soil solution were collected with ceramic micro suction cups in rhizoboxes planted with spruce (laboratory) and from root windows installed in the field. The methods are described in detail in the references cited below. However, the rhizoboxes were watered with nutrient solution from above twice a week (i.e. not continuously via porous ceramic cups). The field plots were watered with 10 mm deionised water with or without AlCl ₃ every 10 days just before the sampling of rhizosphere water.
Do's, don'ts, potential limitations, untested possibilities	<i>Rhizoboxes:</i> do not water from above; the soil water content will then fluctuate too much and thus influence the concentration of the organic acids measured. <i>Field:</i> It does not seem worthwhile to use micro suction cups for collecting rhizosphere water in this type of sandy soil in the field. The sandy soil had such a low water holding capacity that, despite the watering, it was possible to get only a few samples of rhizosphere water during the whole season.
References	<i>Laboratory method described in</i> Dieffenbach, A; Göttlein, A; Matzner, E. 1997. In-situ soil solution chemistry in an acid forest soil as influenced by growing roots of Norway spruce (<i>Picea abies</i> [L.] Karst.). Plant and Soil 192: 57-61. (The rhizoboxes are named rhizotrons in this paper.) <i>Description and application of rhizotrones and root windows in the field</i> Dieffenbach, A.; Matzner, E. 2000. In situ soil solution chemistry in the rhizosphere of mature Norway spruce (<i>Picea abies</i> [L.] Karst) trees. Plant Soil 222: 149-161.

ID	13_Eldhuset_b
Author	Toril D. Eldhuset Norwegian Forest and Landscape Institute, P.O. Box 115, N-1431 Ås, Norway toril.eldhuset@skogoglandskap.no; ++47 64 94 80 00
Parameter	Organic acids, NH₄⁺, K⁺, Ca²⁺, Mg²⁺ in rhizosphere and bulk soil solution
Soil type	Acid washed sand
Plant species	Timothy (<i>Phleum pratense</i>)
System	Rhizobox
Method	Sampling with micro suction cups; Analysis by HPLC and capillary electrophoresis
Method description	Two-week-old timothy plants were planted into rhizoboxes filled with sand and were irrigated via porous ceramic cups. Nutrients were supplied by ion-exchange resins in the rhizoboxes. Eight days after planting, micro suction cups were installed around the roots. Samples of soil solution were collected periodically under a suction of 500 hPa. Organic acids were analysed by HPLC and inorganic ions by capillary electrophoresis.
Do's, don'ts, potential limitations, untested possibilities	Several micro suction cups did not extract enough soil solution for analysis, probably due to the relatively coarse structure of the sand grains preventing sufficient contact with the suction cups. Fe ³⁺ and Al ³⁺ could not be detected in the samples.
References	<i>Experiment described in:</i> Eich-Greatorex, S. 2003. Root distribution as influenced by the chemical conditions in the root-soil environment. Doctor scientiarum theses 2003:13. Agricultural University of Norway. <i>Similar experiment with Picea abies described in:</i> Eldhuset, T.D. 2005. Minor effects of nitrogen availability on organic-acid exudation from roots of young <i>Picea abies</i> plants. Journal of Plant Nutrition and Soil Science 168: 341-342. <i>Principle of the method:</i> Dieffenbach A.; Göttlein, A; Matzner, E. 1997. In-situ soil solution chemistry in an acid forest soil as influenced by growing roots of Norway spruce (<i>Picea abies</i> [L.] Karst.). Plant and Soil 192: 57-61.
Links	Use of ion exchange resins to create chemical gradients are described by 11_Eich-Greatorex

ID	13_Fitz
Author	Fitz, Walter; Wenzel, Walter W. Department of Forest- and Soil Sciences, Institute of Soil Science, BOKU - University of Natural Resources and Applied Life Science Vienna, Peter Jordan Strasse 82, 1190 Vienna, Austria walter.fitz@boku.ac.at; ++43 1 47654 3127 walter.wenzel@boku.ac.at; ++43 1 47654 3125
Parameter	Any chemical or biological plant-induced gradient in the rhizosphere
Soil type	Any
Plant species	Any
System	Rhizobox
Method	Sectioning of rhizosphere soil
Method description	Sectioning of rhizosphere soil using a refrigerated microtome can significantly bias soil chemical parameters (Fitz et al., 2003). Therefore we designed an alternative home-made slicing device which allows soil sectioning of fresh (non frozen) rhizosphere soil at a spatial resolution of 250 µm and less (see Fig. 1). After termination of an experiment, the rhizosphere soil compartment including rhizosphere soil is put on the device and fixed with screws on a plate. This plate is adjustable in all 3 spatial directions as its vertical position is defined by 3 individually adjustable screws. Soil is sliced using a blade made of acrylic material. Acrylic material is used to avoid contamination with metals (Wenzel et al., 1997). The blade is fixed with a screw on a slide at an angle of 45° relative to the soil surface. The slide is led horizontally by two acrylic plates on each side of the device. Successive sectioning is achieved by adjusting the blade which is fixed with screws on a commercially available sliding calliper. Sectioning using this device is far less time-consuming than the application of refrigerated microtomes. The cutting device can be easily home-made and represents therefore a cost-efficient alternative to the application of a refrigerated microtome if high spatial resolutions are required for the description of rhizosphere gradients, e.g. for modeling purposes.
Do's, don'ts, potential limitations, untested possibilities	<i>Do's:</i> Usually nets are used to divide rhizosphere soil from roots. Depending on the rhizobox system used, root hairs penetrating net's and the adjacent rhizosphere soil have to be cut through or sheared of. Otherwise the soil layer penetrated by the rhizosphere soil may stick on the net. <i>Dont's:</i> High soil water contents as well high clay soils may cause problems.
References	<i>Problems with microtome sectioning and description of slicing device:</i> Fitz, W.J.; Wenzel, W.W.; Wieshammer, G; Istenic, B. 2003. Microtome sectioning causes artifacts in rhizobox experiments. Plant Soil 256: 455-462. <i>Advantage of acrylic materials:</i> Wenzel, W.W.; Sletten, R.S.; Brandstetter, A.; Wieshammer, G.; Stinger, G. 1997. Adsorption of trace metals by tension lysimeters: Nylon membrane vs. porous ceramic cup. J.Environ. Quality 26: 1430-1434.
Links	www.rhizo.at

Additional
information

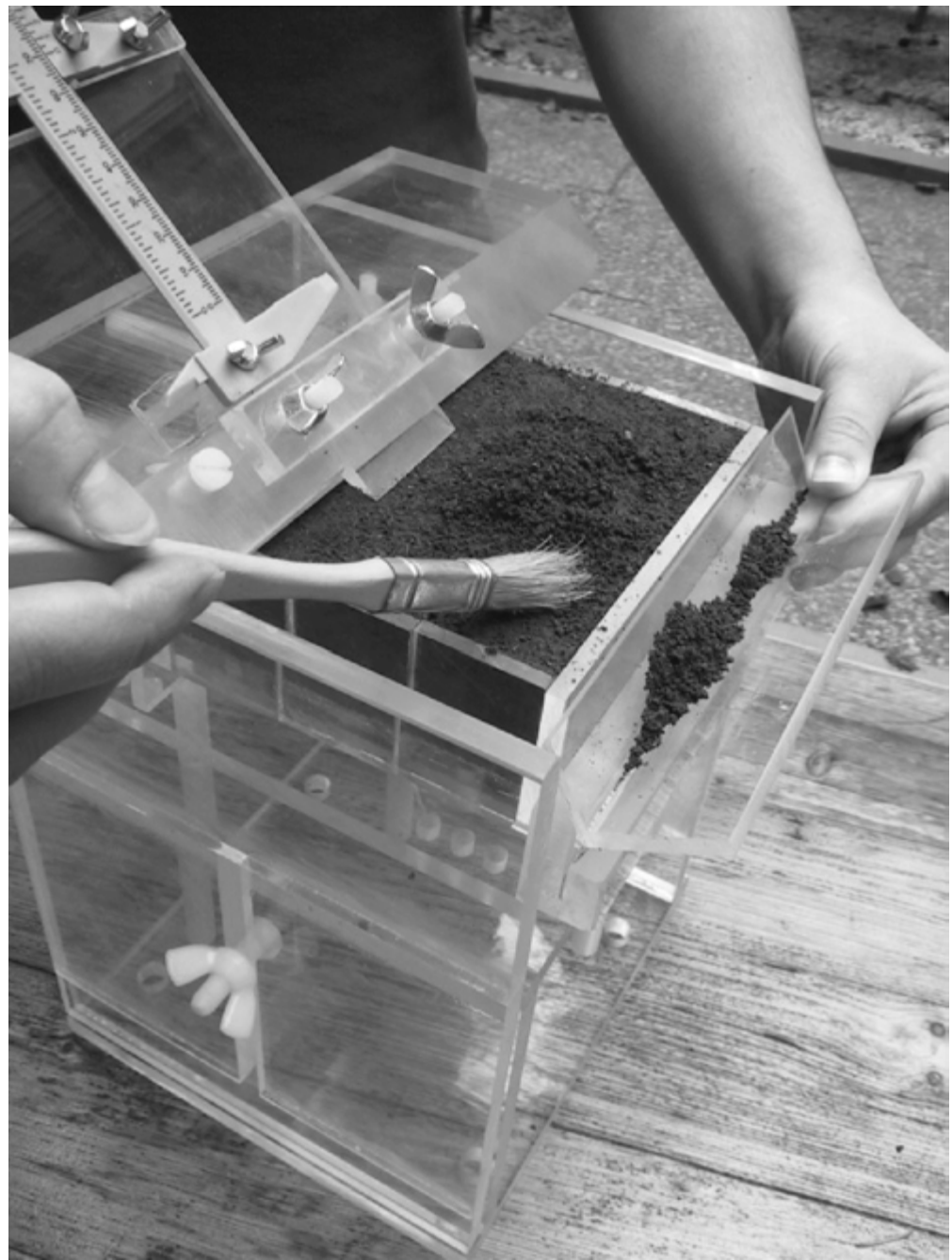

Figure 1.

ID	13_Goettlein
Author	Göttlein, A. Fachgebiet Waldernährung u. Wasserhaushalt Wissenschaftszentrum Weihenstephan, Am Hochanger 13 D-85354 Freising Goettlein@forst.tu-muenchen.de; ++49 8161/71-4749
Parameter	High resolution sampling of soil solution
Soil type	Acid forest soils
Plant species	Beech, Spruce, Oak
System	field and laboratory
Method	Micro suction cups
Method description	Micro suction cups are build from ceramic capillarys (outer diameter 1,0 to 1,2 mm; material: aluminium oxide ceramic, >97% Al ₂ O ₃ ; supplier: PI-Ceramic, D-07598 Lederhose) glued into a PEEK tubing (outer diameter 1/16"). For installation to a root window or a rhizotrone small holes have to be drilled into the transparent plate at the desired position. Special rhizotrones with a 5mm grid of holes in the back plate allow a very flexible installation of micro suction cups without affecting the transparent front plate (see method sheet 11_Goettlein). Prior to the installation of micro suction cups a stainless steel tube is inserted into the drilled hole, serving as guidance for the micro suction cup (Fig. 1). The micro suction cups are connected with a tubing (outer diameter 1/16", inner diameter 0,25 mm) to a vacuum collecting device (Fig. 2) which allows to sample the solution from thirty micro suction cups into individual sample vials. Small pieces of peristaltic pump tubing (inner diameter 1mm) can serve as cheep and secure connection of the 1/16" tubings.
Do's, don'ts, potential limitations, untested possibilities	<ul style="list-style-type: none"> • Prior to use, micro suction cups have to be tested individually for leaks. Because micro suction cups are handmade, their individual flow rate at a given suction often is rather different. Thus it is advisable to use only micro suction cups of comparable flow rate within one experiment. • The bottom of the collecting device should be filled with distilled water to produce a water-vapour saturated atmosphere within the box, thus preventing evaporation of sample droplets hanging at the outlet of the capillary. • The first sample (minimum 4 times the dead volume of micro cup + tubing) should be discarded, because this is needed to equilibrate and flush the system.
References	<p><i>Description of micro suction cups and collecting device</i> Göttlein, A; Hell, U.; Blasek, R. 1996. A system of microscale tensiometry and lysimetry. Geoderma 69: 147-156.</p> <p><i>Examples of applications</i> Wang, Z.Y.; Göttlein, A.; Bartonek, G. 2001. Effects of growing roots of Norway spruce (<i>Picea abies</i> [L.] Karst) and European beech (<i>Fagus sylvatica</i> L.) on rhizosphere soil solution chemistry. J. Plant Nutr. Soil Sci. 164: 35-41.</p> <p>Dieffenbach, A.; Matzner, E. 2000. In situ soil solution chemistry in the rhizosphere of mature Norway spruce (<i>Picea abies</i> [L.] Karst.) trees. Plant Soil 222: 149-161.</p>

Additional Information

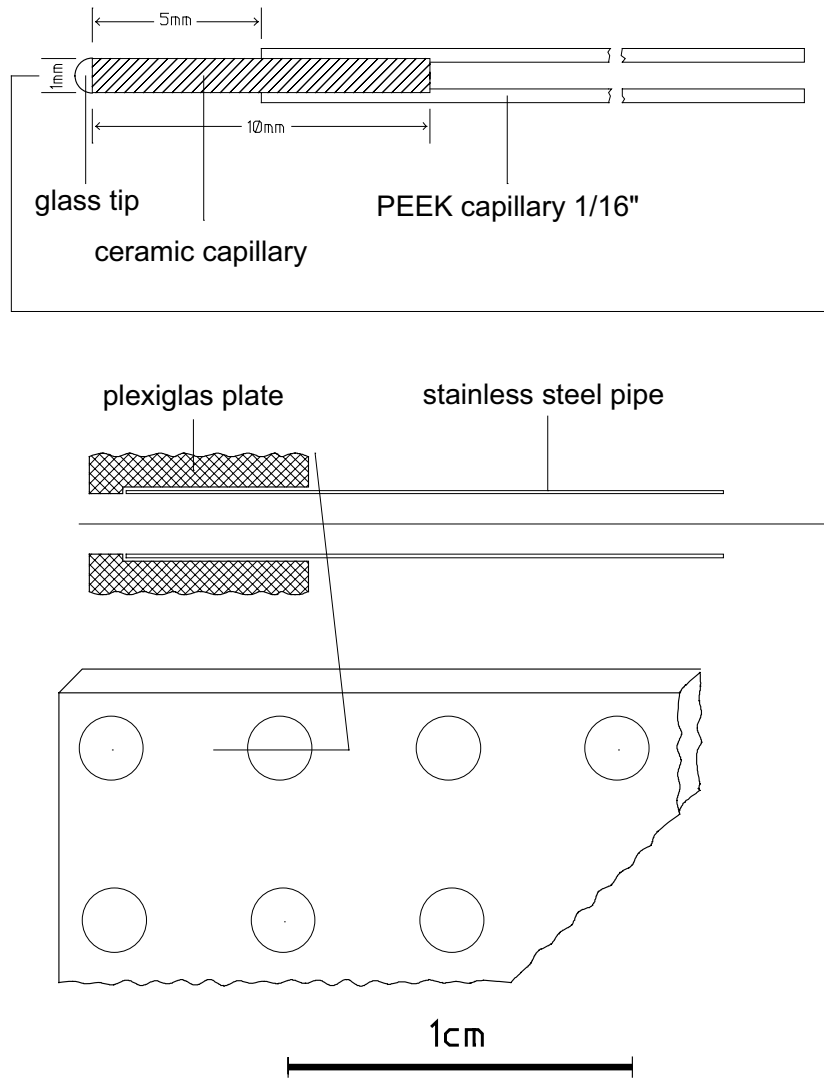

Fig. 1: Details of micro suction cups and their installation (from Göttelein et al. 1996; with permission from Elsevier)

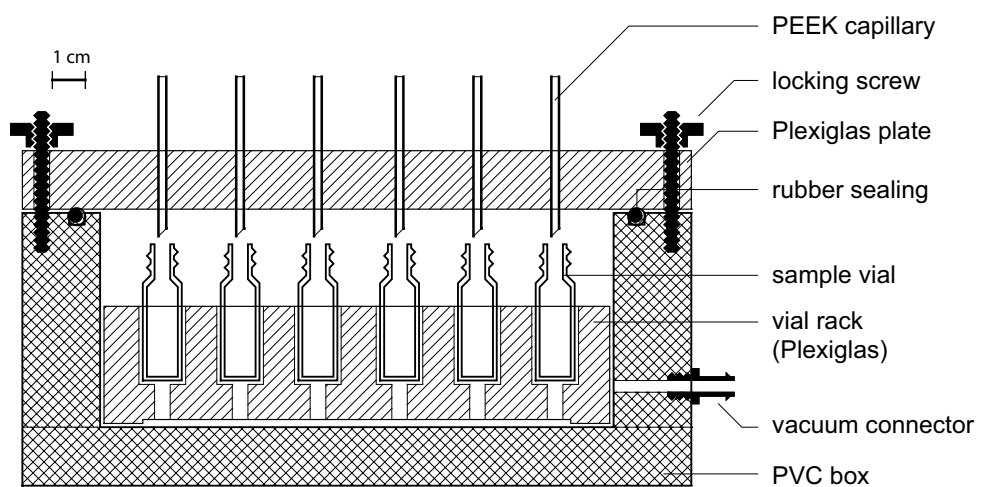

Fig. 2: Vacuum device for collecting samples (from Göttelein et al. 1996; with permission from Elsevier)

ID	13_Graf_Pannatier
Author	Graf Pannatier, Elisabeth; Blaser, Peter; Luster, Jörg Swiss Federal Institute for Forest, Snow, and Landscape Research WSL, CH-8903 Birmensdorf, Switzerland elisabeth.pannatier@wsl.ch; ++41 44 739 23 30
Parameter	Sampling of soil solution
Soil type	Acid and calcareous forest soils
System	Field and model ecosystems
Method	zero-tension lysimetry; tension lysimetry
Method description	<p><i>Sampling below the litter layer:</i> Zero-tension lysimeters consisting of a plexiglas plate, perforated to ensure contact of the litter with the underlying mineral soil, and connected to a polyethylene bottle in which the sample is collected.</p> <p><i>Sampling at different depths in the mineral soil:</i> Tension lysimeters: ceramic cups connected to glass bottles, or cups based on nylon membranes supported by polyethylene substructures and connected to polypropylene bottles. A vacuum is applied manually once at the beginning of each sampling period, or a constant vacuum is established with a membrane pump. For both methods, the vacuum is 60 kPa.</p> <p>The sampling bottles connected to the lysimeters are stored in an insulated and light-protected box. Sampling periods last 1, 2 or 4 weeks depending on the desired sampling resolution and on the sampling bottle capacity. At each sampling event, water volumes are recorded.</p>
Do's, don'ts, potential limitations, untested possibilities	<p><i>Installation and equilibration of tension lysimeters</i> All parts of the lysimeter system in contact with the soil solution sample are acid-washed (0.1 M HCl) and rinsed with deionized water prior to installation. In order to achieve a good hydraulic contact between the suction cup and the soil, a layer of fine soil material or quartz sand is filled in between cups and undisturbed soil. Initial reactions between the soil solution and reactive sites of the cup material can lead to erroneous results. The soil solution collected during the first sampling events should be discarded until the suction cups are field-equilibrated (up to half a year according to our experience). Because of the large spatial variability of the soil solution composition, we use eight replicates on most of our sites to get a representative estimate of the conditions. Soil solution samples collected at the same depth are either pooled or individually analysed to estimate the spatial variability.</p> <p><i>Suction cups:</i> Ceramic cups are well suited with respect to the analysis of major inorganic cations (including Al) and anions. For the monitoring of dissolved organic carbon (DOC), borosilicate suction cups are more suited than ceramic cups that tend to adsorb DOC. If interest is in trace elements like Cu, Zn, Cd or Pb, cups based on nylon membranes should be used because they exhibit the smallest sorption effects.</p> <p><i>Vacuum:</i> The water fraction sampled by tension lysimetry varies with the magnitude of the vacuum applied and the moisture content of the soil during sampling.</p>

	<p>Therefore, both vacuum systems (discontinuous and constant) have limitations compared to a system which regulates the vacuum in dependence of the soil water tension. However, the discontinuous system, i.e. applying a vacuum manually at the beginning of a sampling period, is cheaper and best suited for not easily accessible sites, although the soil solution samples are often not representative of the whole sampling period.</p> <p>Degassing of CO₂ during sampling can increase the pH of the collected solution, especially in forest soils with pH values > 4.5 and pCO₂ in the soil > 0.01 atm.</p>
References	<p><i>Introduction to soil solution chemistry and sampling:</i> Wolt, J. D. 1994. Soil solution chemistry. Applications to Environmental Science and Agriculture. Wiley, New-York, 345 pp.</p> <p><i>Chemical inertness of suction cup material:</i> Rais, D.; Nowack, B.; Schulin, R.; Luster, J. 2006. Sorption of trace metals by standard and micro suction cups in the absence and presence of dissolved organic carbon. J. Environ. Quality 35: 50-60.</p> <p>Wenzel, W. W.; Wieshammer, G. 1995. Suction cup materials and their potential to bias trace metal analyses of soil solutions: a review. Int. J. Environ. Anal. Chem. 59: 277-290.</p> <p>Wenzel, W. W.; Sletten, R.S.; Brandstetter, A.; Wieshammer, G.; Stinger, G. 1997. Adsorption of trace metals by tension lysimeters: Nylon membrane vs. porous ceramic cup. J. Environ. Qual. 26: 1430-1434.</p> <p>Wessel-Bothe, S.; Patzold, S.; Klein, C.; Behre, G.; Welp, G. 2000. Sorption of pesticides and DOC on glass and ceramic suction cups. J. Plant Nutr. Soil Sci. 163: 53-56.</p> <p><i>Number of replicates:</i> Manderscheid, B.; Matzner, E. 1995. Spatial heterogeneity of soil solution chemistry in a mature Norway spruce (<i>Picea abies</i> (L.) karst.) stand. Water, Air Soil Poll. 85: 1185-1190</p> <p><i>Degassing of CO₂:</i> Zabowski, D; Sletten, R.S. 1991. Carbon dioxide degassing effects on the pH of spodosol soil solutions. Soil Sci. Soc. Am. J. 55: 1456-1461</p>
Links	<p>J. Derome et al., 2002. Submanual on Soil Solution Collection and Analysis, http://www.icp-forests.org/Manual.htm</p> <p>E. Graf Pannatier, 2003. Soil solution chemistry and soil water availability in LWF plots, http://www.wsl.ch/projects/soilsol/</p>

ID	13_Lundstroem
Author	Lundström, Ulla S. Dept. of Natural and Environmental Sciences, Mid Sweden University , SE-851 70 Sundsvall, Sweden. Ulla.Lundstrom@mh.se; ++46 60148416, ++4670 2090325
Parameter	Collection of soil solution
Soil type	forest soil
Plant species	pine, spruce
System	field soil
Method	Centrifugation drainage
Method description	The method is especially useful for getting soil solution from the mor layer. Soil samples are taken by driving cylindrical plastic tubes (i.d. 5 cm, length 7 cm) horizontally into one side of a pit. The tubes are centrifuged in special devices at a speed of 14 000 rpm for 30 min as soon as possible (Giesler and Lundström, 1993). A Beckman J2-21 centrifuge equipped with a JA 14 rotor is used. The centrifugates (<1 -20 ml per sample core) are filtrated through a 0.45 µm filter (Millex.HV, Millepore).
Do's, don'ts, potential limitations, untested possibilities	By using this method fresh soil solution samples can be obtained corresponding to about 7.6 MPa. By this method the concentrations of base cations were found to be higher in the mor layer and lower at depths below 0.3 m than obtained by zero tension lysimeters (Giesler et al., 1996). By centrifugation higher concentrations of K and Cl were obtained than by using Rhizon SMS lysimeters (Geibe et al. in prep.)
References	<i>Method described in:</i> Giesler, R.; Lundström, U. 1993. Soil solution chemistry: Effects of bulking soil samples. Soil Sci. Soc. of Am J. 57: 1283-1288. <i>Comparison with zero-tension lysimetry:</i> Giesler, R.; Lundström, U.S.; Grip, H. 1996. Comparison of soil solution chemistry assessment using zero-tension lysimeters or centrifugation. Eur. J. of Soil Sci. 47: 395-405.

ID	13_Luster
Author	Luster, Jörg; Rais, David Swiss Federal Institute for Forest, Snow, and Landscape Research, WSL, CH-8903 Birmensdorf, Switzerland joerg.luster@wsl.ch; ++41 44 739 22 95
Parameter	collection of rhizosphere soil solution, trace metal analysis
System	Laboratory test of materials
Method	micro tension lysimeters
Method description	<i>Materials for the construction of micro suction cups:</i> Ceramic capillaries made from pure Al Oxide (PI Ceramic, Lederhose, Germany); a hollow fibre made from polyvinyl alcohol (PVA; Yanai et al., 1993); a tube made from polyethersulfone (PES; Rhizon MOM; Eijkelkamp Equipment, Giesbeek, Netherlands). <i>Laboratory test</i> Weakly acidic and alkaline solutions with different levels of trace metals (Cu, Zn, Cd, Pb) and dissolved organic matter were pumped through the materials; the "breakthrough" curves were interpreted with respect to the influence of the different materials on the measured soil solution concentration.
Do's, don'ts, potential limitations, untested possibilities	The following summary applies to new acid washed materials; materials that have been operated in soil for some time may behave differently. <ul style="list-style-type: none"> • At alkaline pH, ceramic capillaries were characterized by generally strong sorption of all investigated trace metals. • Sorption of Cu, Zn, and Cd by ceramic capillaries negligible at low pH. • The unknown polymerous tube sorbed Cu strongly, but were well suited to monitor Zn, Cd, and Pb at low pH, and, in the presence of DOC, also at high pH. • Major cations (Na⁺, Mg²⁺, K⁺, Ca²⁺) and anions (Cl⁻, NO₃⁻, SO₄²⁻) were not or very weakly sorbed by all cup materials. • Trace metal sorption by suction cups was generally greatly reduced in presence of DOC, especially at alkaline pH.
References	<i>Results of this laboratory test:</i> Rais, D.; Nowack, B.; Schulin, R.; Luster, J. 2006. Sorption of trace metals by standard and micro suction cups in the absence and presence of dissolved organic carbon. J. Environ. Quality 35: 50-60. <i>Description of PVA hollow fibers:</i> Yanai, J.; Araki, S.; Kyuma, K. 1993. Use of a looped hollow fiber sampler as a device for nondestructive soil solution sampling from the heterogeneous root zone. Soil Sci. Plant Nutr. 39: 737-743. <i>Description of the ceramic capillaries:</i> Göttlein, A.; Hell, U.; and Blasek, R. 1996. A system for microscale tensiometry and lysimetry. Geoderma 69: 147-156.
Links	<i>producer of ceramic capillaries:</i> www.piceramic.de <i>PES tubes:</i> www.eijkelkamp.com (rhizon soil moisture samplers)

ID	13_Nielsen
Author	Nielsen, Niels Erik; Gahoonia, Tara Singh Plant Nutrition and Soil Fertility Laboratory, Dpt. of Agricultural Sciences The Royal Veterinary and Agricultural University Thorvaldsensvej 40; DK-1871 Frederiksberg C, Denmark niels.erik.nielsen@agsci.kvl.dk; ++45 35 28 3480
Parameter	Dynamics of root induced processes and nutrient depletion in rhizosphere soil near root mat
Soil type	Sandy loam
Plant species	Rape
System	Rhizobox
Method	Thin slicing of frozen undisturbed soil by freezing microtome
Method description	<p><i>Pregrowth:</i> Plants are pre-cultured at well-defined nutritional conditions e.g. for 10 days in PVC tubes (L 10 cm, D 4.4 cm) filled with vermiculite (Gahoonia and Nielsen, 1991; 1992). The tubes are closed with nylon cloth impervious to roots in the bottoms. The nutrient solution is supplied via two fibrous wick covered with black PVC foil.</p> <p><i>Rhizobox system:</i> The experimental test soil system includes two connected tubes as follow: i) test soil e.g. sandy loam is filled into PVC tubes (L 3 cm D 5.6 cm) at a density of 1.3 g cm⁻³ (bottom part); ii) the upper part PVC tubes (L 1 cm D 5.6 cm) with a nylon screen of inner mesh size 53 µm at the bottom is also filled with test soil. The nylon screen allows root hairs but prevent penetration of roots into the bottom column part. To maintain defined soil moisture content at e.g. 20 cm water column tension, the test soil column is placed in a small cup-shaped sand bath connected via a fibrous wick to a reservoir of water. The nylon cloth in the bottom of the PVC tubes covering the primary root mat of the pre-cultured seedling is removed. These PVC tubes are then transferred to the test soil system described above. A new root mat is then developed after 1 to 2 days on the top of the nylon screen that constitutes the interface between the test soil and the root mat. During the experimental period (e.g. 10 days) the plants receive a controlled supply of nutrients and water via the fibrous wick (Gahoonia and Nielsen, 1991; 1992). The tension of the nutrient solution in the wicks are equal to or bigger than the tension of the water in the test soil column in order to avoid mass flow from the plant unit to the test soil column.</p> <p><i>Thin slicing:</i> To obtain rhizosphere soil of defined distance from the roots, the test soil column is separated from the root mat, quickly frozen in liquid nitrogen and sliced into thin layers (e.g. 0.06 mm) using a freezing microtome. The soil sample or bulked samples from several replicates may then analysed for root status of root induced inorganic, organic and biological processes including soil enzymes and microbes.</p>
Do's, don'ts, potential limitations, untested	<ul style="list-style-type: none"> The method allows us to study the effect of root-induced processes on turnover, release and uptake of organic and inorganic compounds at well-defined distances from roots. The method allows us also to study associated soil biological parameters and effects of root hairs.

possibilities	<ul style="list-style-type: none"> • The success depends mainly on the reproducibility of the controlled nutritional conditions, soil moisture content and the root mat induced water flow in the test soil column. • One has to be aware of that the root mat configuration speeds up the root induced processes that in some respect are unnatural.
References	<p><i>The experimental set up including the set up to attain controlled nutrition of the plants can be seen in:</i></p> <p>Gahoonia, T.S.; Nielsen, N.E. 1991. A method to study rhizosphere processes in thin soil layer of different proximity to roots. <i>Plant and Soil</i> 135: 143-146.</p> <p>Gahoonia, T.S.; Nielsen, N.E. 1992. Control of pH at soil root interface, <i>Plant and soil</i> 140: 49-54.</p> <p><i>Characterization of soil phosphorus fractions by sequential fractionation procedure in connection wit a study of effects of root-induced pH changes on the depletion of inorganic and organic soil phosphorus in the rhizosphere:</i></p> <p>Gahoonia, T.S.; Nielsen, N.E. 1992. The effects of root-induced pH changes on the depletion of inorganic and organic phosphorus in the rhizosphere. <i>Plant and Soil</i> 143: 185-191.</p>

ID	13_Thiele
Author	Thiele, Björn ¹⁾ ; Lindenmair, Julia ¹⁾ ; Rist, Roland ¹⁾ ; Schoelgens, Edelgard ¹⁾ ; Müller, Marlene ¹⁾ ; Roeb, Marion ¹⁾ ; Kuhn, Arnd Jürgen ¹⁾ ; Klauth, Peter ²⁾ ; Wessel-Bothe, Stefan ³⁾ ¹⁾ Research Centre Jülich, Institute III: Phytosphere, D-52425 Jülich, Germany; b.thiele@fz-juelich.de; ++49 2461 615033 ²⁾ Institute IV: Agrosphere; p.klauth@fz-juelich.de; ++49 2461 618663 ³⁾ EcoTech, Nikolausstr. 7, D-53129 Bonn, Germany ecotech@ecotech-bonn.de; ++49 228 614799
Parameter	Collection of soil solution for organic acid analysis
System	Laboratory test of micro suction cups
Method	Micro tension lysimeters
Method description	<i>Materials for the construction of micro suction cups:</i> Ceramic capillaries (made from Al oxide and borosilicate), teflon tube with a nylon membrane and a hollow fiber made from polyethersulfone (PES). All micro suction cups were disinfected with 3 % hydrogen peroxide prior use. <i>Laboratory test for MO permeability:</i> Bacteria solutions of <i>Pseudomonas fluorescens</i> were sucked through the materials; after plating the eluates on agar plates and incubation for 24 h the number of passed microorganisms (MOs) was determined by counting. <i>Laboratory test for adsorptivity of organic acids :</i> Standard solutions of different organic acids (oxalate, tartrate, acetate, citrate) were sucked through the materials; the "breakthrough" curves were interpreted with respect to the affinity of the different materials to adsorb organic acids.
Do's, don'ts, potential limitations, untested possibilities	<i>MO permeability:</i> <ul style="list-style-type: none"> • Ceramic capillaries and nylon membrane: permeable for MOs • PES hollow fiber: impermeable for MOs <i>Adsorptivity of organic acids:</i> <ul style="list-style-type: none"> • Ceramic capillaries: no adsorption • Nylon membrane and PES hollow fiber: some adsorption, stronger for the hollow fiber
References	<i>Description of the borosilicate ceramic capillaries:</i> EcoTech Umwelt-Meßsysteme GmbH, Nikolausstr. 7, 53129 Bonn, Germany <i>Description of the Al₂O₃ ceramic capillary:</i> Göttlein, A.; Hell, U.; Blasek, R. 1996. A system for microscale tensiometry and lysimetry. Geoderma 69: 147-156. <i>Description of the hollow fiber:</i> Rhizosphere Research Products, F. Meijboom, Dolderstraat 62, 6706JG Wageningen/Netherlands
Links	<i>Description of ceramic suction cups to be downloaded at www.ecoTech-Bonn.de (search for "Bodenlösung")</i>

ID	13_Turpeault
Author	Turpault, Marie-Pierre INRA-BEF, 54280 Champenoux, France turpault@nancy.inra.fr
Parameter	Sampling of rhizosphere soil for physico-chemical and mineralogical soil analyses
Soil type	acid forest soil
Plant species	Mono-species stand of any forest species
System	field soil
Method	Physical separation based on drying and shaking
Method description	A representative area (e.g.: 42 x 30 m) was selected and divided into small plots (e.g.: 6 x 6 m). Soil samples were taken systematically at the geographical intersections of the plots. Soil profiles (a minimum of 18) 30 x 70 cm were dug. Soil samples were taken systematically from different layers which corresponded to soil horizons (e.g.: 0- 5 cm; 5-15 cm and 15-30 cm). On site, all roots < 2-mm were removed carefully by hand. All soil fractions free of roots were collected to give the bulk soil fraction (B) and were air dried. The roots with the adhering soil aggregates < 1 cm were dried immediately in a steam-air dryer at 30°C. Then, the soil fraction that detached spontaneously from the roots after drying was collected to give the rhizosphere (R). The remaining dry root-soil fraction was shaken gently to separate some of the soil film covering the roots to give the rhizosphere interface (RI). All soil samples were sieved through a 200- μ m mesh to give the soil samples used for the chemical analyses.
Do's, don'ts, potential limitations, untested possibilities	<ul style="list-style-type: none"> • Sampling rhizospheric soil is a challenge because the rhizosphere is defined as the zone which is influenced by root activity. The rhizospheric soil presents spatial and temporal variations of these properties and gradients both along the roots and in a perpendicular direction. These gradients can be studied in detail by sampling specific points; for example, the mycorrhizospheric soil of one fungus species can be sampled by isolating all the mycorrhizas of this species and then collecting the adhering soil. In practice, it was the soil adhering to all of the fine roots which was sampled, by eliminating aggregates of a fixed size. The volume was not a homogeneous cylinder covering the whole length of the root, and depended on the soil properties (humidity, clay content etc.) and root activity (mucilage etc.). So, to compare different stands in the same soil, it was necessary to verify the moisture content of soil and the weight of soil fraction R, collected from the same root length. • Soils are heterogeneous environments and many authors have shown that roots can colonise specific zones. So, interpretation of the effect of roots on the rhizospheric soil is limited by the possible colonisation of preferential zones. • To avoid heterogeneity between the particle size distribution of bulk and rhizospheric soil and to eliminate all the small pieces of roots, all soil samples were sieved through a 200-μm mesh. For silty alocrisols, we checked that rhizosphere sampling, as described above, did not result in the preferential sampling of the particle size fraction below 200μm. • It is possible that there were exchanges between the root and soil after sampling. However, these must be very limited as a comparison of

	<p>exchangeable cations in two series of soils from two types of sampling (one as described above and the other by separating the roots from the rhizospheric soil in the field by shaking) did not show any significant differences ($P=0.05$).</p> <ul style="list-style-type: none"> • The soil fraction RI differs from the soil root interface (SRI) used by Gobran and Clegg (1996), as SRI represents the free space apparent within fine roots and adhering rhizospheric soil (< 0.5 mm thick). • This method can be easily adapted to microcosms.
References	<p><i>Definition of a soil root interface:</i> Gobran, G. R.; Clegg, S. 1996. A conceptual model for nutrient availability in the mineral soil-root system. Can. J. Soil Sci. 76:125-131.</p>

ID	13_Vetterlein
Author	Vetterlein, Doris Young Investigators Group BASS, Department of Soil Ecology, Centre for Environmental Research UFZ, Theodor-Lieser-Str. 4, 06120 Halle/Saale, Germany doris.vetterlein@ufz.de; ++49 345 558 5415
Parameter	Changes in soil water content and soil solution composition in the rhizosphere with time
Soil type	Artificial substrates based on quartz of different texture classes (sand, silt, clay)
Plant species	<i>Zea mays</i>
System	Compartment system (Fig.1)
Method	Combination of micro suction cups, microtensiometers and time-domain reflectometry
Method description	<p>Soil solution composition close to the root surface is a dynamic parameter which depends not only on root water and nutrient uptake but also on transport properties of the substrate. Concentrations may change as a result of net transport of ions or changes in soil water content. Hence, it is necessary for the interpretation of soil solution data, that the soil physical characteristics of the substrate, such as the water retention curve for the established bulk density, are known. This enables the evaluation of changes in soil water content during the experiment in respect to changes in soil solution concentrations (e.g. normalisation of concentration data to initial soil water content).</p> <p>Micro suction cups as described by Göttlein (method sheet 13_Göttlein) are used for the collection of soil solution in small volumes. Suction applied for sampling soil solution should be more negative than soil matric potential. Sample volume should be kept small to minimise the impact of sampling on soil solution equilibrium, especially if many suction cups are installed close to each other and/or frequent sampling is intended.</p> <p><i>Microtensiometers</i> consisting of similar ceramic as micro suction cups (\varnothing 1.3 mm) are used for the continuous measurement of soil matric potential which can be converted to soil water content via the water retention curve. For details see Vetterlein & Jahn, 2004a.</p> <p><i>Time-domain reflectometry sensors</i> (TDR) of 50 mm length and an interwire distance of 5 mm (EASY-Test Ltd, Poland) were used to measure soil solution osmotic potential which is a function of the ion activities in the solution and thus an indirect measure for the ionic strength (Vetterlein & Jahn, 2004a).</p> <p><i>All sensors</i> were installed at the same height in a compartment system in the root compartment and with increasing distance from the root compartment. Distance between the sensors depends on the specific experimental requirements. A spatial resolution of 30 mm is sufficient for microtensiometers and TDR sensors unless drought stress experiments are conducted.</p>

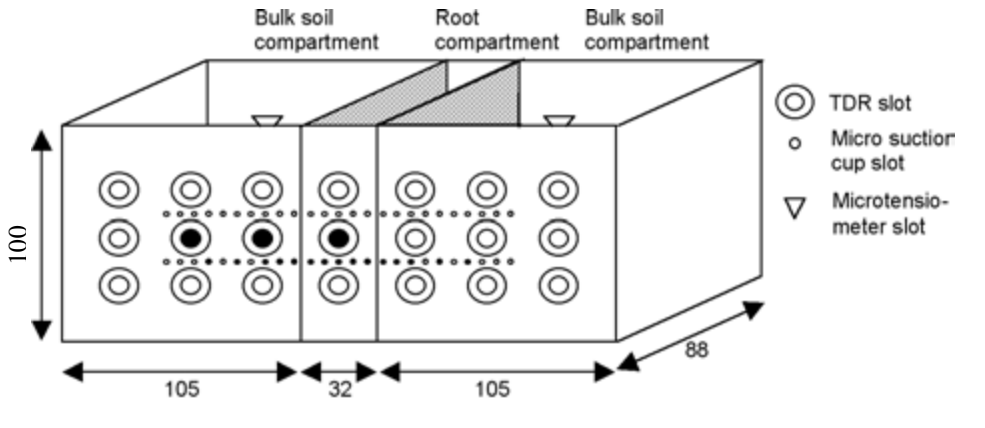
<p>Do's, don'ts, potential limitations, untested possibilities</p>	<p><i>Sensors should not</i> be installed at different heights. Soil water content at equilibrium varies with height above the reference level and this has consequences for soil solution concentrations. In homogenized substrates, as they are often used in greenhouse experiments, the initial amount of nutrients per volume of soil/substrate is the same. As soil moisture varies with soil depth at equilibrium due to gravitational potential, differences in soil solution concentration will occur independent of plant activity.</p> <p><i>Both tensiometers and TDR-sensors</i> provide very high temporal resolution (minutes). Thus they can be used as indicators for the duration of the disequilibrium induced by soil solution sampling. The possible temporal resolution of soil solution sampling can be derived from these measurements. Tensiometers and TDR sensors have a limited measurement range. Conventional tensiometers are limited to matric potential >-100 kPa and for TDR sensors the relation between σ (electric conductivity of the soil matrix) and ϵ (dielectric constant) is only linear over a range of water content from about 12 vol. % to saturation.</p> <p>The compartment system approach can be used as a reference system for the calibration of rhizosphere models. For more information see www.bass.ufz.de</p>
<p>References</p>	<p>Vetterlein, D.; Jahn, R. 2004a. Combination of micro suction cups and time-domain reflectometry to measure osmotic potential gradients between bulk soil and rhizosphere at high resolution in time and space. <i>European Journal of Soil Science</i> 55, 497-504.</p> <p>Vetterlein, D.; Jahn, R. 2004b Gradients in soil solution composition between bulk soil and rhizosphere – in <i>situ</i> measurement with changing soil water content. <i>Plant and Soil</i> 258, 307-317.</p> <p>Vetterlein, D.; Kuhn, K; Schubert, S.; Jahn, R. 2004c Consequences of sodium exclusion for the osmotic potential in the rhizosphere – Comparison of two cultivars differing in Na^+ uptake. <i>Journal of Plant Nutrition and Soil Science</i> 167, 337-344.</p>
<p>Links</p>	<p>www.ufz.de ; www.uni-halle.de; www.bass.ufz.de</p>
<p>Additional information</p>	 <p>Fig.1: Compartment system (from Vetterlein and Jahn 2004a; with permission of Blackwell Publishers)</p>

ID	21_Brunner
Author	Brunner, Ivano Swiss Federal Institute for Forest, Snow, and Landscape Research, WSL, CH-8903 Birmensdorf, Switzerland ivano.brunner@wsl.ch; ++41 44 739 22 84
Parameter	Total element concentrations in fine roots
Soil type	forest soil
Plant species	Picea abies, Pinus montana, Pinus cembra
System	Samples from forests
Method	CN-analyser, ICP-OES
Method description	<i>Sampling and sample preparation:</i> Fine roots (diameter <2 mm) are sampled from forest soils by hand or by a soil coring cylinder, packed in plastic bags, stored in cool-boxes, and transported to the laboratory. The samples are then sieved with a 1 cm mesh sieve and the roots rinsed under tap water. Fine roots that are brittle and disintegrated during handling are considered as dead and are not included. Then the Fine roots are dried for 3 d at 60°C. For element quantification the fine roots are ground with a swing mill. <i>Analyses:</i> Total N and C are quantified using 6-8 mg of ground material placed into ultraclean tin capsules in a CN analyser. Other elements are quantified using 100-250 mg of ground material, digested in a high pressure microwave (2 ml 40% HNO ₃ , 100 µl HF, 240°C, 120 bar), and concentrations measured by inductively-coupled plasma optical emission spectrometry (ICP-OES).
Do's, don'ts, potential limitations, untested possibilities	With these methods, the most common nutrient and trace elements can be measured.
References	Brunner, I.; Brodbeck, S.; Walthert, L. 2002. Fine root chemistry, starch concentration, and 'vitality' of subalpine conifer forests in relation to soil pH. <i>Forest Ecology and Management</i> 165: 75-84. Genenger, M.; Zimmermann, S.; Hallenbarter, D.; Landolt, W.; Frossard, E.; Brunner, I. 2003. Fine root growth and element concentrations of Norway spruce as affected by wood ash and liquid fertilisation. <i>Plant and Soil</i> 255: 253-264.

ID	21_Frey
Author	Frey, Beat Swiss Federal Institute for Forest, Snow, and Landscape Research, WSL, CH-8903 Birmensdorf, Switzerland beat.frey@wsl.ch; ++41 44 739 25 41
Parameter	elemental analysis of root and mycorrhiza tissue
Soil type	forest soil
Plant species	spruce, beech
System	field and laboratory material (rhizoboxes, <i>in vitro</i> cultures)
Method	energy dispersive X-ray microanalysis (EDS)
Method description	Samples are rapidly frozen by plunging them into liquid cryogen (propane or high pressure freezing) and subsequently freeze-dried, cryofractured or cryosectioned in order to image and analyze the inner part. Cryofractures can be directly analyzed in the cryo-SEM. A resolution limit of about 2 µm is indicated for frozen-hydrated samples. This resolution is insufficient to allow separate analysis of cell wall and cytoplasm. Cryosectioning of the rapidly frozen native material represents the alternative method to analyze the plant material with a higher spatial resolution. Preparation and analysis of ultra-thin cryosections is, however, very demanding and there is still very little experience with this technique in plant tissues for analytical purposes.
Do's, don'ts, potential limitations, untested possibilities	<ul style="list-style-type: none"> do not use chemically fixed material potential application in studies on nutrition, interactions between elements in rhizosphere, transport, sequestration and functions of minor and trace elements.
References	<p><i>In all 4 references, a description of the method can be found; in addition, there are examples of results with interpretation:</i></p> <p><i>Application using ultrathin cryosections:</i> Frey, B.; Zierold, K.; Brunner, I. 2000. Extracellular complexation of Cd in the Hartig net and cytosolic Zn sequestration in the fungal mantle of <i>Picea abies</i> – <i>Hebeloma crustuliniforme</i> ectomycorrhizas. <i>Plant, Cell and Environment</i> 23: 1257-1265.</p> <p>Frey, B.; Brunner, I.; Walther, P.; Scheidegger, C.; Zierold, K. 1997. Element localization in ultrathin cryosections of high-pressure frozen ectomycorrhizal spruce roots. <i>Plant, Cell and Environment</i> 20: 929-937.</p> <p><i>Application using cryofractures:</i> Brunner, I.; Frey, B. 2000. Detection and localization of aluminium and heavy metals in ectomycorrhizal Norway spruce seedlings. <i>Environmental Pollution</i> 108: 121-128.</p> <p>Heim, A.; Luster, J.; Brunner, I.; Frey, B.; Frossard, E. 1999. Effect of Al treatment on Norway spruce roots: Element distribution, Al binding forms and release of organic substances. <i>Plant and Soil</i> 216: 103-116.</p>

ID	21_Jansa
Author	Jansa, Jan ETH Zurich, Plant Sciences, Eschikon 33, CH – 8315 Lindau (ZH), Switzerland; jan.jansa@ipw.agrl.ethz.ch; ++41 52 3549216
Parameter	Total content of nonvolatile elements in plant shoots and roots
Soil type	Any
Plant species	any (provided roots can be washed out from the soil and cleaned)
System	both field and pot experiment samples
Method	Atomic spectrometry, ion chromatography, and colorimetry of plant digests (dry ashing)
Method description	<p>This method allows extracting total non-volatile element contents from plant biomass by dry ashing and acid extraction. It has to be coupled with an appropriate detection method for particular elements (P, Zn, K, Mg, Mn, Fe, Ca, Cu) such as inductively coupled plasma-optical emission spectrometry (ICP-OES) or ICP coupled with mass spectrometry (ICP-MS) or colorimetry.</p> <p><i>Sample preparation:</i> Plant samples are dried at 105°C for 24-48 hours (the samples should be brittle), then milled in a centrifuge mill with a sieve of 0.5 mm mesh size. About 300-400 mg of plant biomass is weighed to a china crucible and subjected to ashing in a muffle furnace at 550°C for 6-15 hours (the samples should be grey-white after, if they are black it means there was lack of oxygen during the ashing – prolong the heating). You may consider using lids or Al-foil to cover the crucibles to prevent ash fly – but you may need to prolong the heating time as a consequence. After heating, the furnace has to be opened and left to cool down for 2-3 hours, and only then the samples can be removed (using heat-resistant gloves!) and cooled down to room temperature on a heat-protected place. Two mL of 20% HCl are added to each crucible and heated shortly on a hot plate (250°C) just so that the solution starts moving. DO THIS IN FUME HOOD ONLY as the acid will evaporate producing very irritant smokes. Let the samples cool down, dilute with deionized water (use the best quality of water available only!) and transfer to funnels with ashless filter papers over graduated 50 mL flasks. Rinse the crucibles for two more times adding the solution to the funnel again. Make up to 50 mL with water.</p> <p><i>Elemental analysis:</i> Concentration of nonvolatile elements can be measured with ICP-OES, ICP-MS, or ion chromatography (IC). Standard solutions should contain the same amount of HCl (or another acid) as the extracts. You may consider neutralization of the extracts for IC. For colorimetric estimation of P (e.g. Ohno and Zibilske, 1991), the extracts need to be diluted 1:20 to 1:100 and do not have to be neutralized.</p>
Do's, don'ts, potential limitations, untested possibilities	<p><i>Analytical methods:</i> An appropriate analytical method has to be used for each element along with appropriate standards for the particular elements in the same solution matrix (with respect to pH, ionic strength, etc.) as the samples. Atomic emission spectrometry with plasma flame (ICP-AES) is applicable generally for all elements, but you can also consider using atomic absorption spectrometry (AAS) or colorimetric methods for individual elements such as Zn and P.</p>

	<p>Additional modifications of the solution (pH etc.) might be needed for some methods. HCl extracts are not recommendable for some models of ICP-MS due to high matrix interference. HNO₃ may be used instead.</p> <p><i>Labeled plant material:</i> ³³P or ⁶⁵Zn radioactively labelled samples can also be processed in the same manner, but milling should be avoided to prevent radiation risk to the operator. You may consider cutting the labelled plant biomass with scissors to 0.5-1cm pieces before ashing.</p> <p><i>Amount of sample:</i> For extracting more plant material you need to consider adding more HCl and subsequently to modify the standards so that the solution has the same osmotic and pH properties.</p>
References	<p><i>Detailed description of various extraction methods:</i> Allen, S.E. 1989. Chemical Analysis of Ecological Materials, Oxford, Blackwell, 2nd Ed.</p> <p>Jones, J. B. Jr.; Wolf, B.; Mills, H.A. 1990. Organic matter destruction procedures. In: Plant Analysis Handbook. Micro-Macro Publishing, Inc., Athens, GA, pp. 195-196.</p> <p><i>Colorimetric estimation of P in solution by Malachite Green method:</i> Ohno, T.; Zibilske, L.M. 1991. Determination of low concentrations of phosphorus in soil extracts using Malachite Green. Soil Science Society of America Journal 55: 892-895.</p>
Additional information	available from the author on request

ID	21_McNear
Author	McNear, D.H.; Tappero, R.; Sparks, D.L. Plant and Soil Sciences Dept., University of Delaware, Newark, DE 19717; dlsparks@udel.edu; ++1 302 831 2532
Parameter	Quantitative Elemental Compartmentalization in Plant Tissues
Plant species	Any plant tissue with elemental concentrations exceeding $\sim 100 \mu\text{g g}^{-1}$ dry weight
System	Plant samples grown in a glass house in Ni refinery enriched soils
Method	Synchrotron based X-ray fluorescence and absorption edge computed microtomography (F-CMT and AE-CMT)
Method description	<p><i>Fluorescence CMT</i> Specimen (i.e., leaf, root) is attached to a wooden shaft using epoxy resin (Fig.1C) and then mounted on a rotation-translation stage. XRF intensities are then collected as the specimen is translated through the X-ray beam, rotating by a small angle, repeating the translation-XRF collection, and continuing this process to encompass a total rotation of 180 degrees. Typical datasets are collected with 5 μm translation steps over 1.5 mm, 3° angular steps and dwell times of 1 second resulting in 2-D “sinograms” (intensity on a “position-angle” plot) for each element (up to 13 at once) with total collection times of ~ 5 hours. 2-D element images are then computationally reconstructed using FFT-based Gridrec software (Dowd et. al., 1999), which is controlled by the IDL programming language (Research Systems Inc.) yielding images of the cross-sectional internal metal distributions. See McNear et. al. (2005) for details on elemental quantification.</p> <p><i>Absorption Edge CMT</i> Fresh leaves are removed just prior to analysis and mounted directly to the translation-rotation stage by placing the proximal portion of the leaf into a bead of modeling clay. A synchrotron bending magnet source is used to provide a wide fan X-ray beam for flood field applications. The transmitted X-rays are converted to visible light with a single crystal YAG scintillator and the scintillator is imaged with a microscope objective (10X) projected onto a 1300 x 1030 pixel fast charge-coupled device (CCD) X-ray area detector resulting in a field of view of 2.15 x 1.7 mm and an optical resolution of 3.3 μm. Typical 3D datasets are collected with 0.5 degree steps over 180 degrees and dwell times of 10 seconds. One tomogram is collected with the X-ray beam energy below the absorption edge energy (e.g., 8300 eV for Ni or ~ 30 eV below the Ni K absorption edge) and a second tomogram is acquired above the absorption edge. To enhance absorption contrast, the above-edge energy is selected to coincide with the XANES white line for the element in the plant tissue. This energy is determined empirically by viewing the absorption radiograph in real time as the monochromator energy is scanned manually until the energy of maximum absorption is found. Typical image acquisition times with these settings are 45 min. to 1.5 hours. The two sinograms (above edge and below edge) are subtracted, the difference matrix reconstructed using the Gridrec-based software (Dowd et. al., 1999) and the resulting images stacked and viewed sequentially resulting in a movie depicting the metal distribution from the top (distal) to the bottom (proximal) end of the leaf.</p>

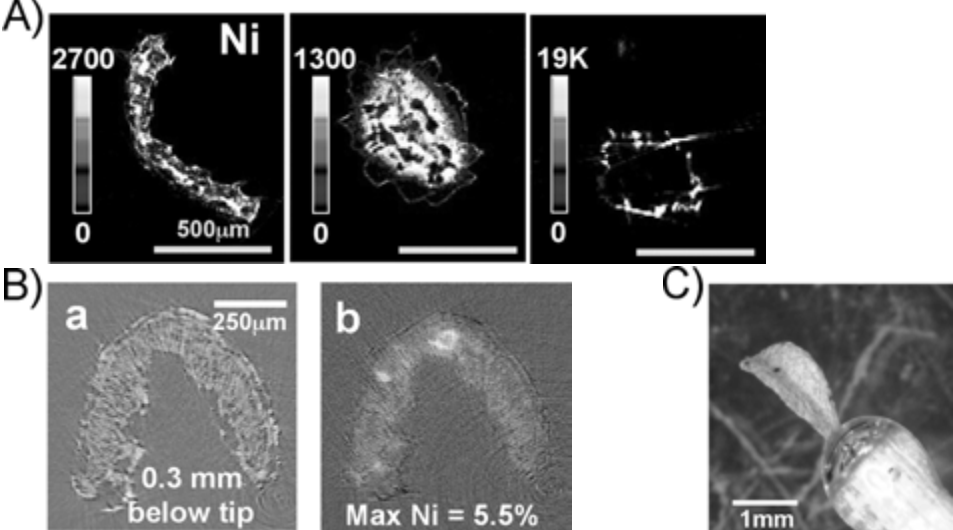
<p>Do's, don'ts, potential limitations, untested possibilities</p>	<p>Limitations</p> <ul style="list-style-type: none"> Freezing and partial drying is required for F-CMT to minimize movement (which compromises reconstruction of the tomogram) due to dehydration from the microfocused X-ray beam. Field of view is limited (F-CMT = 1 mm² ; AE-CMT = 4 mm²) which restricts the size of the object that can be examined. This can be overcome by rolling or folding the material to fit the requisite dimensions. Limited to analyzing elements with atomic numbers greater than Sulfur. Concentration must be greater than 100 mg kg⁻¹ D.W. for F-CMT and 5000 mg kg⁻¹ W.W. for AE-CMT. <p>Possibilities</p> <ul style="list-style-type: none"> still exist for exploring alternative methods for sample preparation that would prevent X-ray beam damage and allow for the analysis of hydrated tissues via F-CMT (e.g., glycerol solvation, paraffin embedding etc.). Coupling F-CMT with AE-CMT provides highly resolved elemental microdistributions as well as confirmation of the ubiquity of the distributions throughout an entire leaf or selected sections of stems and/or roots.
<p>References</p>	<p>Experimental details: McNear, D.; Peltier, E.; Everhart, J.; Chaney, R.L.; Sutton, S.; Newville, M.; Rivers, M.; Sparks, D.L. 2005. The application of fluorescence and absorption edge computed microtomography to image metal compartmentalization in <i>Alyssum murale</i>. Environ. Sci. Technol. 39:2210-2218</p> <p>Application to As sequestration: Keon-Blute, N.; Brabander, D. J.; Hemond, H. F.; Sutton, S. R.; Newville, M.; Rivers, M. 2004. Arsenic sequestration by ferric iron plaque on cattail roots. Environ. Sci. Technol. 38: 6074-6077.</p> <p>Software description: Dowd, B. A.; Campbell, G. H.; Marr, R. B.; Nagarkar, V. V.; Tipnis, S. V.; Axe, L.; Siddons, D. P. 1999. Developments in synchrotron X-ray computed microtomography at the National Synchrotron Light Source. Proceedings of SPIE, Developments in X-Ray Tomography II 3772: 224-236</p>
<p>Links</p>	<p>http://cars9.uchicago.edu/gsecars/GSEmain.html</p>
<p>Additional information (see also colour plates on p. 522)</p>	 <p>Figure 1: A) Ni concentrations (ppm dry weight) and micro-distributions in a leaf, stem and root acquired by F-CMT; B) captured frames from AE-CMT movie showing the Ni conc. (% wet weight) and distribution (brighter regions) 0.3 mm below the tip of an <i>Alyssum murale</i> "Kotodesh" leaf; C) leaf mounted in epoxy resin on the end of wooden shaft for analysis via F-CMT</p>

ID	21_Sainz
Author	Sainz, María J. Departamento de Producción Vegetal, Universidad de Santiago de Compostela, Campus Universitario s/n, E-27002 Lugo, Spain mjsainz@lugo.usc.es; ++34 982 285900
Parameter	Concentration of P, K, Ca, Mg, Na, Fe, Mn, Cu and Zn in plant material
Plant species	Any plant species
System	Material from field, greenhouse, growth chamber
Method	UV/VIS spectrophotometry (colorimetry), atomic emission / absorption spectrometry, ICP-OES of plant digests
Method description	<p><i>Digestion:</i> Plant material must be carefully cleaned and dried in a forced draft oven at 80 ° C until constant weight. The dried plant tissue is finely ground in an agate ball mill, and then dry ashed in a muffle furnace at 500 ° C for at least 4 h. Ashes are digested in HCl to obtain an acid solution of the elements we want to analyze. Digests are then ready for chemical analysis, with appropriate dilutions.</p> <p><i>Elemental analysis:</i> Concentration of elements in plant digests can be determined by several instrumental analytical procedures, with the following considerations:</p> <ul style="list-style-type: none"> • UV/VIS spectrophotometry (colorimetry) is a technique with good selectivity and sensitivity for P. • Flame emission spectrometry is an excellent method for the determination of K and Na, whereas atomic absorption spectrometry (AAS) is widely used for Ca, Mg, Fe, Cu, Mn and Zn. • Inductively coupled plasma optical emission spectrometry (ICP-OES) can simultaneously provide fast multi-element analysis (P, K, Ca, Mg, Na, Fe, Cu, Mn, Zn, Al, B, S, Si) with excellent sensitivity.
Do's, don'ts, potential limitations, untested possibilities	<ul style="list-style-type: none"> • The method of cleaning plant material must be selected depending on the elements to be analyzed; the determination of Fe, Al, Mn and Si can be negatively affected by washing. • Ashes obtained from the muffle furnace can also be digested by acids other than HCl, such as HNO₃. • Digests from dried and ground plant tissue can alternatively be obtained by wet-acid digestion, frequently using HNO₃ with or without H₂O₂ (although sulfuric and perchloric acids are also used), in a microwave oven. • When using ICP-OES, each series of samples should be accompanied by at least one digestion blank (reagents only). For all elements, one portion of a standard reference plant material digested with the same procedure should be included in the analysis. • UV/VIS spectrophotometry and atomic emission/absorption spectrometry are easy to use and have low operating costs, whereas ICP-OES is a high cost investment and has high operating costs. • Trace metals (such as Cd, Co, Cr, Pb) are best analyzed by graphite furnace-atomic absorption spectrometry (GF-AAS) or inductively coupled plasma-mass spectrometry (ICP-MS), both techniques with better detection limits than AAS and ICP-OES.
References	Jones, J.B. 2001. Laboratory Guide for Conducting Soil Tests and Plant Analysis. CRC Press, Boca-Raton.
Links	http://www.varianinc.com/media/sci/apps/icpes003.pdf

ID	21_SasPaszt
Author	Sas-Paszt, Lidia; Stepien, Teresa Research Institute of Pomology and Floriculture, Pomologiczna 18, 96-100 Skierniewice, Poland lsas@insad.pl; ++48 46 834 5235
Parameter	P, K, Mg, Ca, total N and microelements B, Cu, Fe, Mn, Zn in plant material
Soil type	Mineral soil from pomological orchards
Plant species	Strawberry, apple, pear
System	Greenhouse and field experiments with mineral soils
Method	Atomic spectrometry of plant digests (wet ashing), Kjeldahl N
Method description	<p><i>Preparation of the plant material for analysis:</i> A sample of the plant material needs to be air-dried at a temperature not exceeding 65 °C. Grind the dry sample in an impact grinder using a sieve with holes of 1.0 mm in diameter. Transfer the ground plant mass into a plastic container, close and mark according to the adopted system of recording samples.</p> <p><i>Determination of phosphorus, potassium, magnesium, calcium, boron, copper, iron, manganese and zinc content in plant material:</i> In order to determine the mineral content of plant material by chemical means it is necessary to extract the mineral elements into solution. Most of them are contained in organic matter, from which they are released during the process of mineralization (burning). The wet burning of organic matter consists in oxidizing it completely by means of liquid oxidizing agents such as concentrated acids: sulphuric, nitric and perchloric, used individually or in various combinations and at different ratios. To carry out wet mineralization of plant material it is necessary to weigh out, using an analytical balance, 0.5 g of the dried and ground plant material. Put this amount of plant material into a test-tube for mineralization. Pour onto the plant material in the test-tube a mixture containing acids at the following ratio: 75% HNO₃, 15% H₂SO₄, 10% HClO₄. Add 1.0 cm³ of chloroform (CHCl₃), stir and leave for at least 2 hours. After that time carry out mineralization of the plant material by gradual heating up to 220 °C until a clear solution is obtained. Cool the vessels, then fill up with water to obtain the specified volume. The solution prepared in this way is ready for analysis by means of ICP-AES.</p> <p><i>Determination of total nitrogen content of plant material using a modified Kjeldahl's method (by the use of Kjel-Foss apparatus):</i> The Kjeldahl's method consists in complete wet burning of organic material in concentrated sulphuric acid with a suitable catalyst (CuSO₄). Organic nitrogen compounds initially undergo hydrolysis to the basic amino acids, which in turn are mineralized to NH₃, CO₂, SO₂ and H₂O. The released ammonia immediately reacts with the excess of sulphuric acid thus producing ammonium sulfate. The next stage of this process is distillation. The solution obtained following mineralization of organic matter, containing nitrogen in the form (NH₄)₂SO₄, is treated with sodium hydroxide. The excess of NaOH reacts with (NH₄)₂SO₄, which causes ammonia to be released. The ammonia is displaced from the</p>

	<p>solution by steam delivered from a steam generator. Separation of the steam and ammonia takes place in a deflagmator, where the steam condenses while ammonia is carried away through a condenser into a receiver. In the receiver the ammonia combines with sulphuric acid.</p> <p>The amount of sulphuric acid in the first case, and of sodium hydroxide in the second case, which was used up during the titration is then used to calculate the total nitrogen content which is the sum of organic N and NH_4 (excluding NO_3 and NO_2) in the plant material being analyzed.</p>
Do's, don'ts, potential limitations, untested possibilities	To prepare extraction solutions use only analytically pure (AR) or even higher quality reagents and water with a high degree of purity.
References	<p>Szczepaniak W. 1997. Metody instrumentalne w analizie chemicznej. Wydawnictwo Naukowe PWN, Warszawa.</p> <p>Mercik, S. 2002. Chemia Rolna. Podstawy teoretyczne i praktyczne. Wydawnictwo SGGW, Warszawa 2002.</p> <p>Stepien, T.; Palosz, J. 2005. Procedury Badawcze. Centralne Laboratorium Analityczne, ISK, Skierniewice. (available on request from the author).</p>
Additional information	Protocols for extractions and measurements (in Polish and English) available on request from the author.

ID	21_Tappero
Author	Tappero, R.; McNear, D.H.; Marcus, M.A.; Gräfe, M.; Sparks, D.L. Plant and Soil Sciences Dept., University of Delaware, Newark, DE 19717, USA; dlsparks@udel.edu; ++1 302 831 8153
Parameter	(<i>In situ</i>) Elemental distributions, associations, and molecular speciation in plant material
Plant species	Techniques applicable to plant tissue with element concentration exceeding ~100 mg/g D.W.
System	Material from field and laboratory systems
Method	Synchrotron X-ray fluorescence (m-SXRF) imaging and X-ray absorption fine structure (XAFS) spectroscopy
Method description	<p><i>m-SXRF imaging:</i> Plant tissue (fresh, hydrated specimen) is mounted onto an x,y (cryo)stage (rapidly cooled to – 30 °C) positioned at 45° to a microfocused X-ray beam. The beam energy is fixed such that fluorescence signals from all elements of interest are simultaneously detected by a multi-element solid-state detector positioned at 90° to the incident beam. The specimen is rastered in the beam path to generate a coarse map (typically 1 - 3 mm² map with 20 micrometer pixel resolution). Smaller step sizes (e.g., 5 micrometer) and longer dwell times can be used to optimize image resolution (fine map). The multi-element SXRF images are useful for observing (<i>in situ</i>) elemental distributions and associations within the spatial context of the sample (Fig. 1).</p> <p><i>XAFS spectroscopy:</i> Plant specimens mounted for SXRF imaging can be utilized for m-XAFS data collection. Points-of-interest (POIs) identified on the coarse and fine maps are selected for XAFS analysis, and spectra are collected from 200 eV below to 500 - 1000 eV above the designated edge energy (i.e., element specific). Data from the near-edge region (XANES) of the XAFS spectra can be used to investigate the oxidation state of redox-sensitive elements. Data reduction (i.e., background subtraction, normalization, chi extraction) of sample XAFS spectra (bulk and microfocused) and reference spectra is typically followed by principal components analysis (PCA) and linear least squares fitting (LLSF) to determine the primary components and their contribution to the set of sample spectra (Manceau et al., 2002). Molecular-scale information gleaned with XAFS is complemented by the multi-element SXRF images, and together they provide a detailed picture of <i>in situ</i> elemental distributions, associations, and molecular speciation in natural, heterogeneous systems (Fig. 1a-c).</p>
Do's, don'ts, potential limitations, untested possibilities	<ul style="list-style-type: none"> • A cryostage (e.g., thermoelectric Peltier cooler) is crucial for XAFS analysis of fresh, hydrated plant tissue (rapidly cooled to – 30 °C to avoid beam-induced damage), but it is not necessary for m-SXRF imaging. To analyze a specimen without a cryostage, mount the sample (leaf, stem, root, rhizosheath) on Kapton tape. • XAFS data can be collected on frozen or dehydrated plant tissue. Other researchers have ground freeze-dried plant tissue under liquid nitrogen and mounted the powder between Kapton tape or mylar for bulk XAFS analysis (Salt et. al., 1995). • These methods do not resolve the elements having a lower atomic number than sulfur (e.g., oxygen, nitrogen, carbon, or organic fractions). • Detection limits are beamline specific and dependent on the composition

	<p>of the major constituents in the sample (range ~ 20 - 200 mg/kg).</p> <ul style="list-style-type: none"> • Predictions for future developments to this technology include improved spatial resolution (cellular level), detection of lighter (lower Z) elements, and lower detection limits. Run time for most beamlines is limited and access is proposal driven and competitive.
References	<p>Manceau A.; Marcus, M.A.; Tamura, N. 2002. Quantitative speciation of heavy metals in soils and sediments by synchrotron X-ray techniques. In: Fenter, P.; Sturchio, N.C. (Eds.). Applications of Synchrotron Radiation in Low-Temperature Geochemistry and Environmental Science. Reviews in Mineralogy and Geochemistry, Mineralogical Society of America, Washington, DC, Vol. 49: 341-428.</p> <p>Salt, D.E.; Prince, R.C.; Pickering, I.J.; Raskin, I. 1995. Mechanisms of cadmium mobility and accumulation in Indian Mustard. <i>Plant Physiol.</i> 109: 1427-1433.</p> <p>Salt, D.E.; Prince, R.C.; Baker, A.J.M.; Raskin, I.; Pickering, I. 1999. Zinc ligands in the metal hyperaccumulator <i>Thlaspi caerulescens</i> as determined using X-ray absorption spectroscopy. <i>Environ. Sci. and Technol.</i> 33: 713-717.</p> <p>Scheckel, K.; Lombi, E.; Rock, S.; McLaughlin, M. 2004. <i>In Vivo</i> synchrotron study of Thallium speciation and compartmentation in <i>Iberis intermedia</i>. <i>Environ. Sci. Technol.</i> 38: 5095-5100.</p>
Links	http://xraysweb.lbl.gov/uxas/Index.htm
Additional information	Complementary method for soil analysis by SXRF and XAFS (see 22_Tappero) provides more detail on results of data analysis

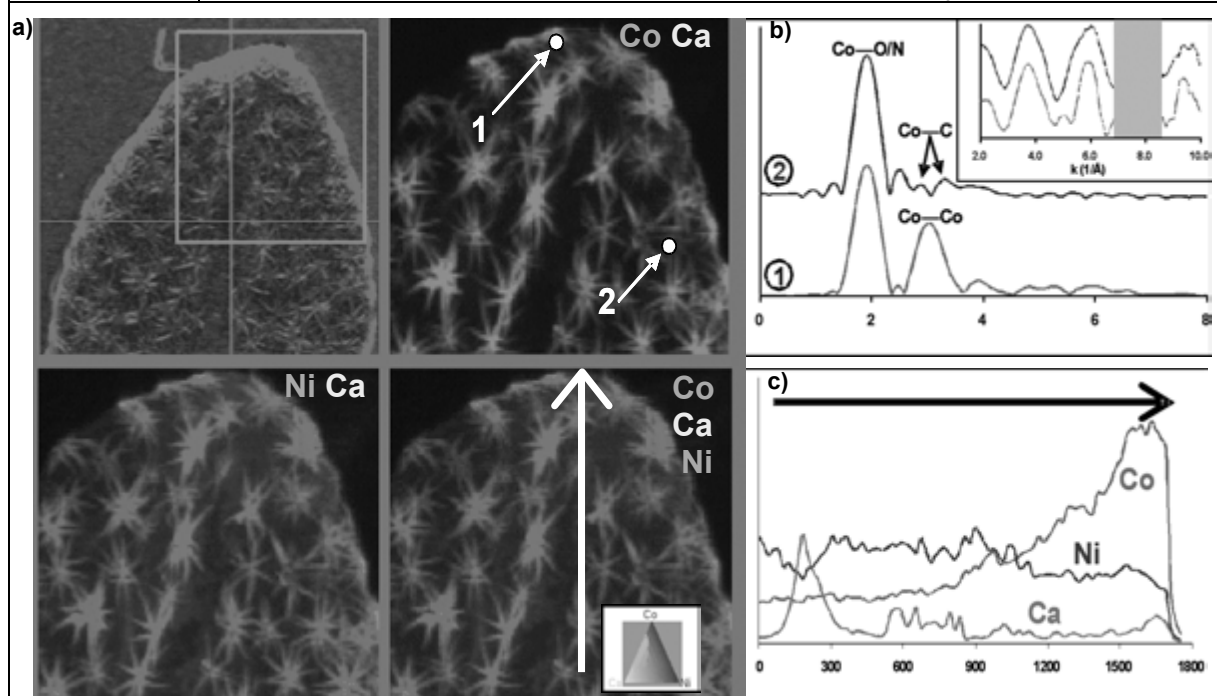

Fig. 1. μ -SXRF images (Co, Ni) of a fresh, hydrated leaf from hyperaccumulator *Alyssum murale* (a), Co-XAFS k^3 -weighted χ (inset) and corresponding Fourier transforms (b) for the leaf tip and mid-leaf region, and line spectra (Co, Ni, Ca) for the region indicated (arrow) on the tricolor SXRF image (c). (see also colour plates on p. 523)

ID	21_Turnau_a
Author	Turnau, Katarzyna Institute of Environmental Sciences, Jagiellonian University, Gronostajowa 7, 30-387 Kraków, Poland turnau@eko.uj.edu.pl; ++48 12 664-51-55
Parameter	element localization and distribution in plant material
Soil type	natural soils and industrial wastes
Plant species	broad range of plants including ferns, liverworts, angio and gymnosperms
System	field and laboratory material (rhizoboxes, <i>in vitro</i> cultures)
Method	electron energy loss spectroscopy (EELS) and imaging (ESI)
Method description	Fixed, dehydrated, resin embedded and ultra-thin sections of ca. 30 nm are analysed by transmission electron microscope accompanied by EELS and ESI.
Do's, don'ts, potential limitations, untested possibilities	<ul style="list-style-type: none"> • Sample preparation is a critical point, both before and during fixation and embedding; freeze-substitution is the most adequate method; • High potential for studies on interactions between components in the mycorrhizosphere, including parallel histochemical studies; • Shows distribution at high magnification; hard to obtain maps of elements for a larger area; presence of hard particles make ultra-thin sections necessary for analysis hard to obtain; the lack of appropriate standards is the weak point of quantitative analysis • The use of appropriate standards and parallel light microscope studies necessary to avoid misinterpretation and artifacts
References	<p><i>Application to mycorrhiza:</i> Kottke I. 1994. Localization and identification of elements in mycorrhizas. Advantages and limits of electron energy-loss spectroscopy. Acta Bot Gallica 141:507-510.</p> <p><i>Detailed description of EELS:</i> Egerton, 1996. Electron energy loss spectroscopy in the electron microscope. New York: Plenum Press.</p> <p><i>On sample preparation:</i> Orlovich, D.A.; Ashford, A.E. 1995. X-ray microanalysis of ion distribution in frozen salt/dextran droplets after freeze-substitution and embedding in anhydrous conditions. J. Microsc.-Oxford 180:117-126.</p>
Additional information	protocols for measurements available from the author on request

ID	21_Turnau_b
Author	Turnau, Katarzyna ¹⁾ ; Przybylowicz, W. ²⁾ ¹⁾ Institute of Environmental Sciences, Jagiellonian University, Gronostajowa 7, 30-387 Kraków, Poland; turnau@eko.uj.edu.pl; ++48 12 664-51-55 ²⁾ Materials Research Group, Themba LABS, Somerset West 7127, South Africa; przybylowicz@tlabs.ac.za; ++27 21 843 3543
Parameter	distribution and quantitative analysis of elements in plant material
Soil type	natural soils and industrial wastes
Plant species	broad range of plants including ferns, liverworts, angio- and gymnosperms
System	field and laboratory material (rhizoboxes, <i>in vitro</i> cultures)
Method	Particle induced X-ray emission (PIXE)
Method description	<i>Sample preparation:</i> Samples are rapidly frozen by plunging them into liquid cryogen (propane, isopentane) cooled by liquid nitrogen and subsequently freeze-dried; roots are subsequently sectioned into slices of about 300 µm thickness; the material is placed between carbon-coated Formvar films previously spread on Al target frames with a hole of ca. 10 mm diameter. <i>Spectroscopic analysis:</i> Quantitative, two dimensional PIXE (particle induced x-ray emission) maps of elemental distribution are obtained
Do's, don'ts, potential limitations, untested possibilities	<ul style="list-style-type: none"> • do not use chemically fixed material • PIXE maps have to be complemented by additional analyses of smaller areas, in which PIXE spectra are fitted using the accurate non-linear least-squares method, and with X-ray yields computed for the actual specimen thickness and composition as found from BS spectra. The method does not need preparation of standards. • Potential application in studies on nutrition, interactions between elements in rhizosphere; transport; sequestration and functions of minor and trace elements • So far no possibilities to study element distribution at the ultrastructural level
References	<i>Detailed description of PIXE:</i> Johansson, S.A.E.; Campbell, J.L.; Malmqvist, K.G. 1995. Particle Induced X-ray Emission spectrometry (PIXE). New York: John Wiley & Sons. Mesjasz-Przybylowicz, J; Przybylowicz, W.J. 2002. Micro-PIXE in plant sciences: Present status and perspectives. Nucl. Instr. Meth. in Physics Res. B 189: 470-481. <i>Application to mycorrhiza:</i> Turnau, K.; Kottke, I. 2005. Fungal activity as determined by micro-scale methods with special emphasis on interactions with heavy metals. In: Dighton, J.; White, J.F.; Oudemans, P. (eds.) The Fungal Community, CRC Press, Boca Ration, pp. 287-306.
Additional information	analysis protocols available on request

ID	21_Turnau_b
Author	Turnau, Katarzyna ¹⁾ ; Przybylowicz, W. ²⁾ ¹⁾ Institute of Environmental Sciences, Jagiellonian University, Gronostajowa 7, 30-387 Kraków, Poland; turnau@eko.uj.edu.pl; ++48 12 664-51-55 ²⁾ Materials Research Group, Themba LABS, Somerset West 7127, South Africa; przybylowicz@tlabs.ac.za; ++27 21 843 3543
Parameter	distribution and quantitative analysis of elements in plant material
Soil type	natural soils and industrial wastes
Plant species	broad range of plants including ferns, liverworts, angio- and gymnosperms
System	field and laboratory material (rhizoboxes, <i>in vitro</i> cultures)
Method	Particle induced X-ray emission (PIXE)
Method description	<i>Sample preparation:</i> Samples are rapidly frozen by plunging them into liquid cryogen (propane, isopentane) cooled by liquid nitrogen and subsequently freeze-dried; roots are subsequently sectioned into slices of about 300 µm thickness; the material is placed between carbon-coated Formvar films previously spread on Al target frames with a hole of ca. 10 mm diameter. <i>Spectroscopic analysis:</i> Quantitative, two dimensional PIXE (particle induced x-ray emission) maps of elemental distribution are obtained
Do's, don'ts, potential limitations, untested possibilities	<ul style="list-style-type: none"> • do not use chemically fixed material • PIXE maps have to be complemented by additional analyses of smaller areas, in which PIXE spectra are fitted using the accurate non-linear least-squares method, and with X-ray yields computed for the actual specimen thickness and composition as found from BS spectra. The method does not need preparation of standards. • Potential application in studies on nutrition, interactions between elements in rhizosphere; transport; sequestration and functions of minor and trace elements • So far no possibilities to study element distribution at the ultrastructural level
References	<i>Detailed description of PIXE:</i> Johansson, S.A.E.; Campbell, J.L.; Malmqvist, K.G. 1995. Particle Induced X-ray Emission spectrometry (PIXE). New York: John Wiley & Sons. Mesjasz-Przybylowicz, J; Przybylowicz, W.J. 2002. Micro-PIXE in plant sciences: Present status and perspectives. Nucl. Instr. Meth. in Physics Res. B 189: 470-481. <i>Application to mycorrhiza:</i> Turnau, K.; Kottke, I. 2005. Fungal activity as determined by micro-scale methods with special emphasis on interactions with heavy metals. In: Dighton, J.; White, J.F.; Oudemans, P. (eds.) The Fungal Community, CRC Press, Boca Ration, pp. 287-306.
Additional information	analysis protocols available on request

ID	22_Boularbah
Author	Boularbah, Ali ¹⁾ ; Schwartz, Christophe ²⁾ ; Bitton, Gabriel ³⁾ ¹⁾ Dept. Biologie, Fac. Sci. & Techn., Guéliz, BP. 549, 40 000, M-Marrakech, Morocco ; boularbah@fstg-marrakech.ac.ma ; ++212 44 43 31 63 ²⁾ ENSAIA-INPL/INRA, UMR 1120 Sols et Environnement, BP 172, F-54505 Vandœuvre-lès-Nancy Cedex, France ³⁾ Dept. Environmental Engineering Sciences, Univ. of Florida, Gainesville, FL, 32611, U.S.A
Parameter	Inhibition of the β-galactosidase activity in a mutant strain of <i>Escherichia coli</i>, by bioavailable heavy metals
Soil type	Agricultural, urban or industrial soils
Plant species	No specification
System	Soils sampled from agricultural, urban or industrial soils
Method	MetPLATE: A direct solid-phase assay for rapid assessment of heavy metal bioavailability to plants
Method description	Soil contamination with heavy metals introduces toxicants into the soil-plant system, thus threatening the food chain. In order to assess the risk of contamination of the food chain by heavy metals, it is indispensable to find approaches to the estimation of the bioavailable fraction of toxic metals in soils. A chemical approach based on selective extractions has been used mostly. Recently, microbial and enzymatic toxicity assays called MetPLATE, have been developed to assess toxicity of metals in aquatic environments. A solid-phase version of MetPLATE has been developed to assess heavy metal toxicity associated with solids (e.g., soil, sediment, biosolids; 0.5 to 1 g aliquots). A test Kit, MetPLATE™, is based, on inhibition, by bioavailable heavy metals in aqueous samples, of the enzyme β -galactosidase in a mutant strain of <i>Escherichia coli</i> . It responds rapidly, and gives a quantitative estimate of the toxicity of the medium. The sensitivity of MetPLATE to heavy metals (Cu, Zn, Cd, Pb, Hg, Ni) is generally higher than Microtox. MetPLATE is also insensitive to organic compounds at concentration higher than those found in the environment. This test can be run concurrently with other assays for general toxicity to determine the nature of chemicals causing toxicity. In the solid-phase MetPLATE, the test bacteria were exposed directly to the solids and assayed for β -galactosidase activity following a one-hr incubation period. A control and blank were added to take into account any interaction between the enzymatic product (chlorophenol red) and solid matrix as well as interferences due the presence of color and indigenous β -galactosidase.
Do's, don'ts, potential limitations, untested possibilities	Successful applications: The solid-phase MetPLATE was applied on artificially contaminated soils, soils that have been amended with urban wastewater sludges or contaminated with dry deposition from metal-plating industries, and subsequently treated with minerals to reduce the mobility of metals (Boularbah <i>et al.</i> , 1996). The response given by MetPLATE when testing soil samples was compared to the response of plants (<i>Lolium perenne</i> , <i>Lactuca sativa</i>) grown in the same soils and to selective chemical extraction using water and CaCl ₂ . MetPLATE showed a correlation with soluble and exchangeable metals (mobility) and with metals in plant tissues

	<p>(phytoavailability). These findings show that short-term microbial assays such as MetPLATE could be suitable for a rapid assessment of metal phytoavailability in agricultural, urban or industrial soils.</p> <p><i>Limitations:</i> The MetPLATE-phase solid test is too sensitive for soils which were quite acidic (pH < 5). For acidic soils, we can use the indirect method that calls for soil extraction followed by assay of the extracts for metal toxicity using MetPLATE or MetPAD (Bitton et al., 1992; 1994).</p>
References	<p><i>Application to extracts from acid soils:</i> Bitton, G.; Jung, K.; Koopman, B. 1994. Evaluation of a microplate assay specific for heavy metal toxicity. Arch. Environ. Contam. Toxicol. 27: 25-28.</p> <p>Bitton, G.; Garland, E.; Kong, I.C.; Morel, J.L.; Koopman, B. 1996. A Direct solid phase assay for heavy metal toxicity. I. Methodology. J. Soil Contam. 5: 385-394.</p> <p><i>Applications to soil solid phase:</i> Boularbah, A.; Morel, J.L.; Bitton, G.; Mench, M. 1996. A Direct solid phase assay for heavy metal toxicity. II. Assessment of heavy metal Immobilization in soils and bioavailability to plants. J. Soil Contam. 5: 395-404.</p> <p><i>Other references:</i> Pierzynski, G.M.; Schwab, A.P. 1993. Bioavailability of zinc, cadmium, and lead in metal-contaminated alluvial soil. J. Environ. Qual. 22:247-254.</p> <p>Wenzel, W.W.; Jockwer, F. 1999. Accumulation of heavy metals in plants grown on mineralized soils of Austrian Alps. Environ. Pollution 104: 145-155.</p> <p>Whitten, M.G.; Ritchie, G.S.P. 1991. Calcium chloride extractable cadmium as an estimate of cadmium uptake by subterranean clover. Aust. J. Soil Res. 29: 215-221.</p>
Links	http://www.ees.ufl.edu/homepp/bitton/
Additional information	A more detailed protocol is available upon request from the author.

ID	22_Calba
Author	Calba, Henri ; Cazevieille, Patrick ; Szwarc, Marc CIRAD TA40/01, avenue d'Agropolis, F-34398 Montpellier Cedex 5, France ; henri.calba@cirad.fr ; ++33 4 67 61 56 30
Parameter	pH, CEC, and exchangeable cations in soil
Soil type	Any soil
Method	cobalthexamine chloride extraction
Method description	<p><i>Solution of cobalthexamine chloride:</i> Dissolve 22.29 g of $\text{Co}(\text{NH}_3)_6\text{Cl}_3$ ($M_w=267.48$) in 1 litre of pure water : the solution contains 250 mmol_c of $\text{Co}(\text{NH}_3)_6^{3+}$ per litre. To have the best accuracy, the concentration C_0 of extraction solution must be such that $2 \text{ CEC} \leq C_0 \leq 8 \text{ CEC}$, where CEC is the estimated CEC of the soil sample. For calcareous soils, this range is extended to $1.5 \text{ CEC} \leq C_0 \leq 8 \text{ CEC}$. When the CEC of the soil sample is not known, a visual inspection of the color of the solution before and after exchange can be carried out by using 3 increasing concentrations of cobalthexamine (5, 10, 20 mmole_c per 100 g of soil for example).</p> <p><i>Soil extraction:</i> The extraction ratio soil : extractant is 1 : 20: 3.5 g of soil is weighed with the precision balance and introduced into a centrifugation tube. A volume of 70 ml of cobalthexamine solution of concentration C_0 is then added into the tube. The tube is agitated on agitator tumbler for 2 hours. At the end of the agitation the pH of the supernatant solution is measured in order to determine exchangeable protons. After centrifugation during 5 minutes with 5000 r.p.m., the supernatant is filtered using a filter without ash and the filtrate preserved for analysis of the cations, including Co, by inductively-coupled plasma optical emission spectrometry (ICP / OES).</p> <p><i>Calculation of the cation exchange capacity:</i> If T is the quantity of cobalthexamine added in the solution, X the quantity remaining after soil extraction, the soil exchange capacity CEC is: $\text{CEC} = \tilde{T} - X$ (in mmole_c per 100 g of soil).</p> <p><i>Calculation of the concentration of exchangeable protons:</i> The pH value in the extraction solution is called $\text{pH}_{\text{cobalthexamine}}$. For a soil : extractant ratio of 1 : 20, the concentration of exchangeable protons in the soil sample is : $\{H^+\} = 2000 \cdot 10^{\tilde{\text{pH}}_{\text{cobalthexamine}}}$ (in mmole_c per 100 g or cmole_c per kg of soil).</p>
References	<p>Orsini, L.; Remy, J.-C. 1976. Utilisation du chlorure de cobalthexamine pour la détermination simultanée de la capacité d'échange cationique et des bases échangeables des sols. Science du Sol 4: 269-275.</p> <p>AFNOR. 1999. Norme X31-130. Détermination de la capacité d'échange cationique et des cations extractibles.</p>
Links	http://www.cirad.fr/activites/labo_analyse/pdf/catsignet.pdf

ID	22_Friedel_a
Author	Friedel, Juergen Dpt. of Sustainable Agricultural Systems, Division of Organic Farming, University of Applied Life Sciences and Renewable Resources Vienna, Gregor Mendel Str. 33, A-1180 Vienna juergen.friedel@boku.ac.at; ++43 1 476 543 757;
Parameter	Soil ammonium and nitrate
Soil type	agricultural soils
Method	Photometric determination in soil extracts
Method description	Soil is extracted with 0.0125 M CaCl ₂ in a soil : solution ratio of 1 : 4 for 30 min. Other extracting agents may be used as well. <i>Ammonium</i> Ammonium in soil extracts is detected photometrically at 675 nm by a modified Berthelot reaction using salicylate and dichlorisocyanurate (Krom, 1980). <i>Nitrate</i> Nitrate in soil extracts is detected photometrically at 210 nm (Navone, 1964). Humic substances also absorbing at 210 nm have to be determined separately after reducing nitrate in the samples with copperized zinc granules over night.
Do's, don'ts, potential limitations, untested possibilities	Solutions have to settle completely before measurement in a photometer because flakes rubbed off the surface of the granules can interfere with the measurement..
References	<i>Ammonium determination method:</i> Krom, M. D. 1980. Spectrophotometric determination of ammonia. A study of a modified Berthelot reaction using salicylate and dichlorisocyanurate. The Analyst 105: 305-316. <i>Nitrate determination method:</i> Navone, R. 1964. Proposed method for nitrate in potable water. J. American Water Works Ass. 56: 781-783.

ID	22_Friedel_b
Author	Friedel, Juergen Dpt. of Sustainable Agricultural Systems, Division of Organic Farming, University of Applied Life Sciences and Renewable Resources Vienna, Gregor Mendel Str. 33, A-1180 Vienna juergen.friedel@boku.ac.at; ++43 1 47654 3757
Parameter	Soil microbial biomass C and N in the rhizosphere
Soil type	Agricultural soils
Method	Dissolved organic C and N determination in 0.5 M K₂SO₄ soil extract
Method description	<i>Extraction:</i> Soil is extracted with 0.5 M K ₂ SO ₄ in a soil:solution ratio of 1 : 15 for 30 min. (see also method sheet on chloroform fumigation extraction method in rhizobox samples: 42_Friedel_b). Microbial biomass C and N is estimated by measuring dissolved organic C (DOC) and N (DON) in the extract. <i>DOC:</i> Solutions are injected into the reactor of a TOC/TN _b Analyzer (TOC 100, Dimatec, Germany) and C is oxidized at 850°C on a catalyst. CO ₂ is detected by an IR detector. <i>DON:</i> Solutions are injected into the reactor of a TOC/TN _b Analyzer (TOC 100, Dimatec, Germany), N is oxidized at 850°C on a catalyst and then converted to NO in a TN _b module by ozone. NO is detected by chemoluminescence.
Do's, don'ts, potential limitations, untested possibilities	<ul style="list-style-type: none"> • It is recommended to dilute K₂SO₄ solutions before analysis to reduce the amount of salt injected into the Analyzer. Analyzers containing valves are unsuitable for 0.5 M K₂SO₄ solution on the long run. • When using KCl solution as an extracting agent, regularly check the chloride adsorber of the TOC/TN_b Analyzer, otherwise the IR detector may be damaged! • For N, detection efficiency varies from 80 to 100 % depending on the chemical nature of the N containing substance.
References	Friedel, J. K.; Gabel, D. 2001. Nitrogen pools and turnover in arable soils under different durations of organic farming: I: Pool sizes of total soil nitrogen, microbial biomass nitrogen, and potentially mineralizable nitrogen. J. Plant Nutr. Soil Sci. 164: 415-419.
Links	<i>Description of TOC/TN_b Analyzer:</i> http://www.dimatec.de

ID	22_Luster_a
Author	Luster, Jörg; Blaser, Peter Swiss Federal Institute for Forest, Snow and Landscape Research, WSL, Zürcherstrasse 111, CH-8903 Birmensdorf, Switzerland joerg.luster@wsl.ch; ++41 44 739 22 95
Parameter	Soil acidity; soil cation exchange capacity (CEC), base saturation, and BC/Al ratio
Soil type	Acid and calcareous soils
Method	Soil pH using water or CaCl₂ extracts; exchangeable acidity by KCl extraction; exchangeable cations by NH₄Cl extraction
Method description	<p><i>Sample preparation</i> Soil samples are dried at 60°C and sieved to obtain fine earth < 2mm.</p> <p><i>Soil pH</i> The pH is measured potentiometrically in a soil suspension with doubly deionised water or with 0.01 M CaCl₂ (1:2 for mineral soils, 1:4 for organic surface layers; equilibration time of 30 min).</p> <p><i>Exchangeable cations</i> Extraction with 1 M NH₄Cl (soil : extractant 1 : 10, 1h, 20°C). Determination of element concentrations (Na, K, Mg, Ca, Al, Mn, Fe) in the filtered extract by inductively-coupled plasma optical emission spectrometry (ICP / OES).</p> <p><i>Exchangeable acidity</i> Extraction with 1 M KCl (1:10, 1h). Titration of the extract with NaOH to pH 8.2 (total acidity). Masking of Al with F. Back titration of the liberated OH with HCl (Al acidity). The exchangeable H acidity is the difference between total and Al acidity.</p> <p><i>Calculations</i> The cation exchange capacity (CEC) of a soil is the sum of all exchangeable cations and the exchangeable H acidity expressed in moles of charge per kg of soil. The base saturation is the sum of exchangeable Na, K, Mg and Ca in percent of CEC. The BC/Al ratio is the sum of the exchangeable nutrient cations K, Mg and Ca (also called base cations) divided by exchangeable Al (in moles per kg)</p>
Do's, don'ts, potential limitations, untested possibilities	<p><i>Soil pH</i> Due to exchange reactions, the pH measured in 0.01 M CaCl₂ is up to 1 pH unit higher than the pH measured in water. For most soil samples, the difference is between 0.4 and 0.8 units.</p> <p><i>Chemical identity of exchangeable cations</i> In calcareous soils, NH₄Cl can dissolve carbonates as well, and exchangeable Ca will be overestimated. For acid soils, exchangeable cations and acidity effectively can be assigned to ions occupying the cation exchanger sites of the soil. The calculation of a CEC based on the methods described above is a rather simplified way. For more sophisticated methods and relevant theoretical considerations see the literature cited below.</p>

	<p><i>Interpretations</i> The soil pH is taken as a measure of the current acidity in a given soil horizon. The degree of soil acidification in a soil horizon can be estimated by taking into account also the base saturation. This is based on the fact that, with increasing soil acidification, Al liberated during weathering is displacing nutrient cations at the exchange sites. In soil horizons with BC/Al < 0.2, there is a risk of toxic effects on root growth and nutrient uptake by plant roots.</p> <p><i>Applications to rhizosphere soil</i> So far, we have applied these methods to bulk soil only. However, considering the amounts, the methods for exchangeable cations and acidity could be easily adapted to rhizosphere soil.</p>
References	<p><i>For a detailed discussion of the analytical methods see the chapters 16 (pH), 17 (exchangeable acidity), 19, 20, 40 (exchangeable cations) in</i> Sparks, D.L. (ed.). 1996. Methods of Soil Analysis, Part 3: Chemical Methods. Soil Sci. Soc. Am., Madison, WI.</p> <p><i>Considerations on assessing soil acidity and soil acidification (in German):</i> Walther, L.; Zimmermann, S.; Blaser, P.; Luster, J.; Lüscher, P. 2004. Waldböden der Schweiz. Band 1. Grundlagen und Region Jura. Swiss Federal Institute for Forest, Snow and Landscape Research, Birmensdorf; Hep Verlag, Bern.</p> <p><i>Applications to acid forest soils:</i> Blaser, P.; Kernebeck, P.; Tebbens, L.; van Breemen, N.; Luster, J. 1997. Cryptopodzolic Soils in Switzerland. Eur. J. Soil Sci. 48: 411-423.</p> <p>Blaser, P.; Zysset, M.; Zimmermann, S.; Luster, J. 1999. Soil Acidification in Southern Switzerland between 1987 and 1997: A Case Study Based on the Critical Load Concept. Environ. Sci. Technol. 33, 14: 2383-2389.</p> <p><i>Comparison between soil acidity and response of trees:</i> Brunner, I. ; Rigling, D. ; Egli, S. ; Blaser, P. 1999. Response of Norway spruce seedlings in relation to chemical properties of forest soils. For. Ecol. Manag. 116: 71-81</p>

ID	22_Luster_b
Author	Luster, Jörg; Graf Pannatier, Elisabeth; Zimmermann, Stefan; Blaser, Peter Swiss Federal Institute for Forest, Snow and Landscape Research, WSL, Zürcherstrasse 111; CH-8903 Birmensdorf, Switzerland joerg.luster@wsl.ch; ++41 44 739 22 95
Parameter	Reactive and Soluble Trace Elements in Soils
Soil type	Acid and calcareous soils
Method	buffered EDTA extraction; water extraction
Method description	<p><i>Sample preparation:</i> Soil samples are dried at 60°C and sieved to obtain fine earth < 2mm.</p> <p><i>Reactive metal contents:</i> Extraction with 0.02 M EDTA, buffered at pH 4.65 with 0.5 M acetate (soil : extractant ratio 1 : 10; 1 h; 20 °C). Determination of metal concentrations in the filtered extract by inductively-coupled plasma optical emission spectrometry (ICP / OES).</p> <p><i>Soluble metal contents:</i> Extraction with doubly deionised water (1 : 10, 16 h). Determination of metal concentrations in the membrane filtered (0.45 µm) extract by inductively-coupled plasma mass spectrometry (ICP / MS). As basis for the calculation of element activities, additional parameters are determined (pH, dissolved organic carbon, inorganic carbon, major inorganic cations, inorganic anions; see 23_Graf-Pannatier).</p> <p><i>Calculations:</i> For a given metal, partition coefficients of the Freundlich type are calculated as ratios between the reactive content and the (activity)ⁿ (n being the Freundlich coefficient) in the water extract. The activities are calculated from the measured concentrations using a chemical equilibrium model that accounts for metal interactions with DOM (e.g. WHAM 6). Transfer-functions are developed to model the partition coefficients in terms of soil organic matter content and soil pH (see 22_Luster_c and 22_Luster_a).</p>
Do's, don'ts, potential limitations, untested possibilities	<p><i>Methodological restraints</i> The buffered EDTA extraction is thought to assess potentially plant available metal pools. It is suitable mainly for acid soils. In calcareous soils, the available metal pools may be overestimated due to excessive carbonate dissolution. However, for heavy metals that form comparatively weak complexes with EDTA, underestimation may also be the case due to EDTA saturation with Ca. Water extracts of dried soils are an operationally simple approach to obtain soil solution for a large number of samples (in particular of archive samples). However, water extracts are only of limited representativity of real world soil solutions. In particular, a mineralisation burst upon addition of water to the dried soil leads to strongly increased concentrations of dissolved organic matter. This can affect also soluble concentrations of trace metals.</p> <p><i>Transfer functions and Critical Loads of Heavy Metals</i> "Critical loads of heavy metals" are defined as the atmospheric metal deposition rate below which harmful effects on a specified sensitive element</p>

	<p>of the environment do not occur at a given location. The target are effects of heavy metals in soil solution on sensitive organisms. A respective critical metal concentration in the soil solution defines the critical limit the critical load is referred to. Transfer functions between reactive and soluble pools, and between total and reactive pools serve to calculate critical loads from available data for sites without information on the soil solution.</p> <p><i>Applications to rhizosphere soil</i> So far, we have applied these methods to bulk soil only. However, considering the amounts of extract needed, the EDTA extraction could be easily adapted to rhizosphere soil. However, for the complete characterization of water extracts, microanalytical techniques are needed.</p>
References	<p><i>Methodology for reactive metal contents:</i> Lakanen E.; Ervio R.A. 1971. Acta Agr. Fenn. 123: 223–232.</p> <p>Zimmermann, S. 1997. Wirkung einer gepufferten Ammonium-Acetat-EDTA-Extraktion auf ausgewählte Bodenbestandteile und natürlichen Bodenproben. Thesis Swiss Federal Institute of Technology, ETH Nr. 12134 (in German)</p> <p><i>Water extracts, methodology and application to forest soils:</i> Luster, J.; Zimmermann, S.; Rais, D.; Blaser, P. 2003. Trace Element Concentrations in the Soil Solution of Swiss Forest Soils as Estimated by Water Extractions. - In: Gobran, G.R.; Lepp, N. (eds). Proc. 7th Intern. Conf. on the Biogeochem. of Trace Elements, Uppsala, Sweden, June 15-19, 2003, 416-417.</p> <p><i>Soluble heavy metal contents in forest soils as related to total metal contents and plant uptake</i> Blaser, P.; Zimmermann, S.; Luster, J.; Shotyk, W. 2000. Critical examination of trace element enrichments and depletions in soils: As, Cr, Cu, Ni, Pb, and Zn in Swiss forest soils. - Sci. Total Environ. 249: 257-280.</p> <p>Blaser P.; Brunner I. 2003. In: Gobran G.R. and Lepp N. (eds) Proc. 7th Intern. Conf. on the Biogeochem. of Trace Elements, Uppsala, Sweden, June 15-19, 2003: 418-419.</p> <p><i>Basis for critical load calculations:</i> De Vries W.; Bakker D.J. 1998. Wageningen, the Netherlands, DLO Winand Staring Centre, Report 166.</p> <p><i>Equilibrium model:</i> WHAM 6, 2001: Windermere Humic Aqueous Model, Equilibrium chemical speciation for natural waters, Version 6.0. @Natural Environment Research Council</p>

ID	22_Luster_c
Author	Luster, Jörg; Blaser, Peter; Walthert, Lorenz Swiss Federal Institute for Forest, Snow and Landscape Research, WSL, Zürcherstrasse 111, CH-8903 Birmensdorf, Switzerland joerg.luster@wsl.ch; ++41 44 739 22 95
Parameter	Soil nutrient status
Soil type	Acid and calcareous soils
Method	Exchangeable cations by NH₄Cl extraction; P fractionation; Total C and N, inorganic C
Method description	<p><i>Sample preparation:</i> Soil samples are dried at 60°C and sieved to obtain fine earth < 2mm, which is used for most analyses. For analysis of total C and N as well as of inorganic C, samples are finely ground.</p> <p><i>P fractionation:</i> Phosphate in all of the following extracts is determined colorimetrically using the molybdenum blue method:</p> <ul style="list-style-type: none"> • <i>Inorganic P:</i> Extraction with 0.5 M H₂SO₄ (soil : extractant 1 : 50, 16h) • <i>Total extractable P:</i> as for inorganic P, but after ashing the soil sample at 550 °C • <i>Organic P:</i> difference between total extractable and inorganic P. • <i>Available P, acid soils:</i> Extraction with 0.03 M NH₄F / 0.025 M HCl (1:7, 1 min) • <i>Available P, soils with pH > 6 in 0.01 M CaCl₂:</i> extraction with 0.5 M NaHCO₃, pH 8.5 (1:20, 30 min, 25 °C). <p><i>C fractionation and total N contents</i></p> <ul style="list-style-type: none"> • <i>total C and N:</i> dry combustion with automatic analyzer. • <i>Inorganic C</i> is expelled from the soil sample as CO₂ upon addition of H₂SO₄. The CO₂ is trapped on a resin carrying NaOH and determined gravimetrically. • <i>Organic C:</i> difference between total and inorganic C. <p><i>Exchangeable cations and acidity, cation exchange capacity (CEC), base saturation: see 22_Luster_a.</i></p> <p><i>Calculations</i></p> <ul style="list-style-type: none"> • C/N ratio: mass ratio between organic C and total N. • C/P ratio: mass ratio between organic C and organic P. • The pools of K, Mg, Ca, C, N and P are estimated using exchangeable K, Mg and C, organic C, total N, and total extractable P, respectively, together with density of the fine earth and rock content.

<p>Do's, don'ts, potential limitations, untested possibilities</p>	<p><i>Chemical identity of fractions</i> While all P fractions are operationally defined, the C fractions and total N contents represent pretty much what the name says. The organic matter content can be estimated from the organic C content by multiplication with 1.72 (mineral soil) or 2.0 (organic surface layers).</p> <p><i>Interpretations</i></p> <ul style="list-style-type: none"> • Both C/N and C/P ratios are linked to biological activity, and, therefore, turnover rates of soil organic matter and availability of nutrients, i.e. the smaller the ratios, the higher the biological activity. There are typical ranges of C/N and C/P ratios for a given humus form (mull, moder, mor). • The CEC is a measure for the potential capacity of soils to hold nutrient cations. It is determined mainly by content of clay and soil organic matter. Depending on the degree of soil acidification, the cation exchange sites are occupied either by nutrient cations or Al (<i>base saturation</i>, see 22_Luster_a). • The pools of exchangeable K, Mg and Ca are interpreted as easily accessible by plants and used as a basis for the classification of the availability of these nutrients in a given soil. So far, we have not used similar classifications based on available P fractions. <p><i>Applications to rhizosphere soil</i> So far, we have applied these methods to bulk soil only. However, considering the amounts, all methods could be adapted to rhizosphere soil.</p>
<p>References</p>	<p><i>For a detailed discussion of the analytical methods see the chapters 15 (inorganic C), 32 (P fractions), 34 (total C), and 37 (total N) in :</i> Sparks, D.L. (ed.). 1996. Methods of Soil Analysis, Part 3: Chemical Methods. Soil Sci. Soc. Am., Madison, WI</p> <p><i>Considerations on assessing nutrient availability and pools (in German):</i> Walther, L.; Zimmermann, S.; Blaser, P.; Luster, J.; Lüscher, P. 2004. Waldböden der Schweiz. Band 1. Grundlagen und Region Jura. Swiss Federal Institute for Forest, Snow and Landscape Research, Birmensdorf; Hep Verlag, Bern.</p> <p><i>Classification of C/N and C/P ratios as well as of K, Mg and Ca pools (in German):</i> Arbeitskreis Standortkartierung 1996. Forstliche Standortsaufnahme. Begriffe, Definitionen, Einteilungen, Kennzeichnungen, Erläuterungen. 5th edition, IHW-Verlag, München, 352 pp.</p>

ID	22_Manceau
Author	Manceau, Alain LGIT - Maison des Géosciences, Université J. Fourier - BP 53, F-38041 Grenoble Cedex 9, France; Alain.Manceau@ujf-grenoble.fr ; ++33 4 76 82 80 15
Parameter	Molecular speciation of trace metals in solid phases, and elemental associations at the micrometer scale
Soil type	Techniques applicable to all solid matrices
System	Field soil, microcosms
Method	Synchrotron-based X-ray microfluorescence (SXRF), microdiffraction (micro-XRD), and extended X-ray absorption fine structure (EXAFS) spectroscopy
Method description	<p><i>Sample preparation:</i> Ideally, measurements are performed on 30 micron-thick micropolished thin sections prepared from a chunk of rhizosphere impregnated with high purity resin (e.g., Scotchcast™ epoxy). The initial soil texture should be preserved as much as possible.</p> <p><i>SXRF</i> is applied first to map elemental content and distribution at the micrometer scale.</p> <p>Then, <i>micro-XRD</i> from selected points-of-interest (POIs) on SXRF maps is used to identify the nature of the crystalline phase(s) in the probed sample volume. When the measurement is performed on a spot containing the element of interest, the likely host phase is identified. This technique can be applied in reflection geometry if the sample is not transparent to X-rays (e.g., sample mounted on a glass or quartz slide), or in transmission geometry, if the sample can be detached from its support (e.g., self-supporting film).</p> <p><i>Micro-EXAFS</i> selectively yields the average binding environment of the trace metal in the prospective host phase(s). In case of phase mixture, this technique may also help to differentiate two prospective host candidates as long as they have a contrasted local structure or chemical composition (which is generally the case). In short, micro-EXAFS allows one to identify the individual metal species (i.e., structural forms of a same element) contained in a multi-component matrix.</p> <p>Once all the unknown species have been identified with a microbeam, their proportions in the whole substrate can be determined by <i>powder EXAFS spectroscopy</i>. The technique consists to record the EXAFS spectrum of a powdered sample representative of the soil (rhizosphere) volume with a macrobeam (e.g., several square millimeters), and to least-squares fit the bulk average spectrum with a linear combination of the previously identified component spectra.</p>
Do's, don'ts, potential limitations, untested possibilities	<ul style="list-style-type: none"> • Caution should be taken to not modify the initial form of the metal species during the sample preparation and during synchrotron measurements by photon-assisted oxidation or reduction. This problem can be circumvented by decreasing the time exposure, photon density, or temperature. • In Europe, the most critical problem to this three-pronged approach to the

	<p>speciation of metals in the rhizosphere is the current lack of X-ray beamlines on which these three powerful X-ray techniques can be applied in synergy. The situation should improve in the coming years with the ongoing development of dedicated X-ray microprobes at ANKA (Germany), the SLS (Switzerland) and Diamond (UK). However, given the growing societal demand for speciation studies in many areas, the access to the installations by the soil science community will remain critical over the coming decade, and will restrain the development of these techniques as a routine tool in Europe.</p>
References	<p><i>Overview article:</i> Manceau, A.; Marcus, M.A.; Tamura, N. 2002. Quantitative speciation of heavy metals in soils and sediments by synchrotron X-ray techniques. In: Fenter, P.; Rivers, M.; Sturchio, N.C.; Sutton, S.(eds.). Applications of Synchrotron Radiation in Low-Temperature Geochemistry and Environmental Science, Reviews in Mineralogy and Geochemistry, Mineralogical Society of America, Washington, DC., Vol. 49: 341-428.</p> <p><i>Natural speciation of metals in soils:</i> Manceau, A.; Marcus, M.A.; Tamura, N.; Proux, O.; Geoffroy, N.; Lanson, B. 2004. Natural speciation of Zn at the micrometer scale in a clayey soil using X-ray fluorescence, absorption, and diffraction. Geochimica et Cosmochimica Acta 68: 2467-2483.</p> <p><i>Speciation of metals in contaminated soils and sediments:</i> Isaure, M.P.; Manceau, A.; Geoffroy, N.; Laboudigue, A.; Tamura, N.; Marcus, M.A. 2005. Zinc mobility and speciation in soil covered by contaminated dredged sediment using micrometer-scale and bulk-averaging X-ray fluorescence, absorption and diffraction techniques. Geochimica et Cosmochimica Acta 69: 1173-1198</p> <p><i>Speciation of metals in the rhizosphere:</i> Panfili, F.; Manceau, A.; Sarret, G.; Spadini, L.; Kirpichtchikova, T.; Bert V.; Laboudigue, A.; Marcus, M.A.; Ahamdach, N.; Libert, M.F. 2005. The effect of phytostabilization on Zn speciation in a dredged contaminated sediment using scanning electron microscopy, X-ray fluorescence, EXAFS spectroscopy and principal components analysis. Geochimica et Cosmochimica Acta 69: 2265-2284.</p>
Links	<p>http://www-lgit.obs.ujf-grenoble.fr/users/manceau/</p>

ID	22_Mollier
Author	Mollier, Alain; Morel, Christian INRA TCEM, 71 avenue Edouard Bourleaux, 33883 Villenave d'Ornon, France; mollier@bordeaux.inra.fr; ++33 5 57 12 25 20
Parameter	Dynamic of the diffusive soil (ortho)phosphate
Soil type	Any materials: agricultural soils, fluvial sediments and suspended sediments, sewage sludge,...
System	Batch experiments on soil suspensions at steady state
Method	Sorption and $^{32}\text{PO}_4$ labeling and dilution kinetics
Method description	<p><i>Soil sample preparation.</i> Soil samples are air-dried, pass and ground to 2 mm sieve.</p> <p><i>Sorption step.</i> For a given soil sample, 5 increasing amounts of P (as KH_2PO_4) are added in soil suspensions (soil-to-solution ratio of 1-to-10) in triplicate and then pre-equilibrated for 40 h (21°C) with a biocide to get a steady state for the subsequent few hours of isotopic dilution.</p> <p><i>Radioactive labeling of (ortho)phosphate (P) in solution and isotopic dilution kinetic.</i> A known amount of $^{32}\text{PO}_4$ ionic species (negligible compared to the amount of $^{31}\text{PO}_4$ present in solution) is introduced in solution of soil suspensions. Both the isotopic dilution ratio and the P ions concentration in solution (C_p, mg P L⁻¹ solution) are determined after several periods (t, minutes) on filtered (<0.2µm) solution by liquid scintillation counting and colorimetric method, respectively. According to previous studies, usually 3 short periods of isotopic dilution are sufficient to determine the parameterization of the dynamic of the diffusive soil P. The gross amount (P_r, mg P kg⁻¹ soil) of P groups onto the soil solid phase that can equilibrate the solution is calculated i) assuming no discrimination between $^{31}\text{PO}_4$ and $^{32}\text{PO}_4$ species and ii) using isotopic dilution principle: the isotopic composition of P ions in solution is the same than the isotopic composition of P onto the soil solid phase that equilibrate solution.</p> <p><i>Modeling the dynamic of diffusive soil P.</i> It results in a set of 15 experimental P_r vs. C_p and t values (Figure). This data set is then used to parameterize by nonlinear regression the gross dynamic of diffusive soil P using the deterministic kinetic Freundlich equation ($P_r = v C_p^w t^p$).</p> <p>Fig. 1. Experimental (symbols) and modeled (lines) P_r values for a representative soil sample (Haplic Luvisol) of agricultural French lands. The kinetic Freundlich equation was: $P_r = 19.8 C_p^{0.47} t^{0.19}$ with $r^2 = >0.99$ for 15 experimental values. The kinetic Freundlich equation has been applied and validated for periods up to 1 year (Morel et al., 2004).</p>
Do's, don'ts, potential	<ul style="list-style-type: none"> This procedure allow us to quantify the dynamic of soil P which is governed by the molecular agitation at the solid-to-solution interface of soil. This driving force is a

limitations, untested possibilities	<p>permanent mechanism. It is a basic information used to mechanistically assess the amount of plant-available soil P as the amount of P ions in solution plus the amount of diffusive soil P over the period of cropping. The kinetic Freundlich equation allows us to mimic and quantify an elementary and obligatory action of roots on its environment during the absorption process: the amount of diffusive soil P that is mobilized by the gradient of concentration at the solid-to-liquid interface of soil induced by roots absorption. Both the intensity of this gradient and its duration can be accounted for. Also, several others parameters, often used to characterize the transfer at the solid-to-solution interface of soil such as P sorption and buffer capacities (Ehlert et al., 2003), the distribution coefficient, the rate of P transfer, sorption-desorption curves, can be derived from this modeling.</p> <ul style="list-style-type: none"> • The isotopic labeling and dilution analysis method has also successfully been used for others ionic species (Cd, Zn (see Sinaj)) and for several materials (Némery et al., 2005; Kvarnström et al., 2004). • One possible limitation of this experimental approach is the accurate determination of the concentration of the ionic phosphate species due to the detection limit of methods and bias induced by the presence of colloids and complexes in solution (Masson et al., 2001; Sinaj et al., 1998).
Additional information	<p>Among all processes that can govern the soil P availability to plants, the mechanism of diffusion of P ions at the solid-to-liquid interface of soil is of prime importance because it is a permanent and obligatory process in the P acquisition by roots. However, P diffusion is scarcely assessed in rhizosphere studies although its appropriate quantification is a preliminary step before analyzing the eventual contribution of others process, such as mineralization of organic P, H⁺ excretion..., in plant nutrition. It has been reported that the proposed modeling of the diffusive soil P dynamic gave an accurate prediction of annual changes in plant-available soil P under several decades of cultivation and fertilization (Morel et al., 2004). It also significantly improved the accuracy of the plant diagnosis (Morel et al., 2000).</p>
References	<p>Némery J.; Garnier, J.; Morel, C. 2005. Phosphorus budget in the Marne Watershed (France): urban vs. diffuse sources, dissolved vs particulate form. <i>Biogeochemistry</i>, 72: 35-66.</p> <p>Morel, C.; Schneider, A.; Plénet, D. 2004. Modeling phosphorus bioavailability in the arable layer of a sandy soil cropped and fertilized for 28 years. <i>Geophysical Research Abstracts</i> 6: 00216.</p> <p>Kvarnström, E.; Morel, C.; Krosstad, T. 2004. Plant-availability of phosphorus in filter substrates derived from small-scale wastewater treatment systems. <i>Ecological Engineering</i> 22: 1-15.</p> <p>Ehlert, P.; Morel, C.; Fotyma, M.; Destain, J.P. 2003. Potential role of phosphate buffering capacity of soils in fertilizer management strategies fitted to environmental goals. <i>J. Plant Nutr. Soil Sci.</i> 166: 409-415.</p> <p>Masson, P.; Morel, C.; Martin, E.; Oberson, A.; Friesen, D. 2001. Comparison of soluble P in soil water extracts determined by ion chromatography, colorimetric and induced coupled plasma techniques in ppb range. <i>Comm. Soil Science Plant Anal.</i> 33: 2241-2253.</p> <p>Morel, C.; Tunney, H.; Plénet, D.; Pellerin, S. 2000. Transfer of phosphate ion between soil and solution. <i>Perspectives in soil testing. J. Environ. Qual.</i> 29: 50-59.</p> <p>Morel, C.; Hinsinger, P. 1999. Root-induced modifications of the transfer of phosphate ions between soil solution and soil solid phase. <i>Plant Soil</i> 211:103-110.</p> <p>Sinaj, S.; Mähler, F.; Frossard, E.; Faïsse, C.; Oberson, A.; Morel, C. 1998. Interferences of colloidal particles in the determination of orthophosphate concentrations. <i>Comm. Soil Science Plant Anal.</i> 29: 1091-1105.</p> <p>Fardeau, J.C., 1996. Review on the use of isotopes for soil P dynamics. <i>Fert. Res.</i> 45, 91-100.</p>

ID	22_Nowack																																		
Author	Nowack, Bernd ¹⁾ ; Luster, Jörg ²⁾ ¹⁾ EMPA – Materials Science and Technology, Lerchenfeldstrasse 6, CH-9014 St. Gallen, Switzerland nowack@empa.ch; ++41 71 274 76 92 ²⁾ Swiss Federal Institute for Forest, Snow, and Landscape Research, WSL, CH-8903 Birmensdorf, Switzerland joerg.luster@wsl.ch; ++41 44 739 22 95																																		
Parameter	Solid phase speciation of heavy metals																																		
Soil type	all soil types																																		
System	homogenized soil samples																																		
Method	Sequential extraction (Zeien and Brümmer)																																		
Method description	<p><i>Sample preparation</i> Soil samples are dried at 40°C and sieved to obtain fine earth of < 2 mm. The residue of the 6th step in the sequential extraction scheme described below is dried and finely ground for X-ray fluorescence spectrometry.</p> <p><i>Sequential extraction scheme</i> The sequential extraction fractionates the solid-phase forms of metals in the soil. The method is based on the use of a series of reagents to solubilize successively the different mineral fractions into operationally defined fractions. There are many sequential extraction schemes in use. In this contribution the scheme according to Zeien and Brümmer (1989) is described. The soil is extracted sequentially with solutions of constantly decreasing pH and increasing extraction strength (2 g of soil, in duplicate). Seven fractions are obtained that are operationally defined (see table below).</p> <table border="1"> <thead> <tr> <th>Fraction</th> <th>chemical interpretation</th> <th>extraction conditions</th> <th>duration</th> </tr> </thead> <tbody> <tr> <td>F1</td> <td>mobile</td> <td>1 M NH₄NO₃</td> <td>24 hours</td> </tr> <tr> <td>F2</td> <td>easily mobilisable</td> <td>1 M NH₄-acetate (pH 6)</td> <td>24 hours</td> </tr> <tr> <td>F3</td> <td>bound to Mn-oxides</td> <td>0.1 M NH₂OH-HCl + 1 M NH₄-acetate (pH 6)</td> <td>30 min.</td> </tr> <tr> <td>F4</td> <td>bound to organic matter</td> <td>0.025 M NH₄EDTA (pH 4.6)</td> <td>90 min.</td> </tr> <tr> <td>F5</td> <td>bound to amorphous Fe-oxides</td> <td>0.2 M NH₄-oxalate (pH 3.25)</td> <td>4 hours in the dark</td> </tr> <tr> <td>F6</td> <td>bound to crystalline Fe-oxides</td> <td>0.1 M ascorbic acid + 0.2 M NH₄-oxalate (pH 3.25)</td> <td>30 min. at 96 °C</td> </tr> <tr> <td>F7</td> <td>residual fraction</td> <td>X-ray fluorescence analysis</td> <td></td> </tr> </tbody> </table> <p>We used X-ray fluorescence spectrometry for the residual amount (F7). The original method uses acid digestion for this step.</p>			Fraction	chemical interpretation	extraction conditions	duration	F1	mobile	1 M NH ₄ NO ₃	24 hours	F2	easily mobilisable	1 M NH ₄ -acetate (pH 6)	24 hours	F3	bound to Mn-oxides	0.1 M NH ₂ OH-HCl + 1 M NH ₄ -acetate (pH 6)	30 min.	F4	bound to organic matter	0.025 M NH ₄ EDTA (pH 4.6)	90 min.	F5	bound to amorphous Fe-oxides	0.2 M NH ₄ -oxalate (pH 3.25)	4 hours in the dark	F6	bound to crystalline Fe-oxides	0.1 M ascorbic acid + 0.2 M NH ₄ -oxalate (pH 3.25)	30 min. at 96 °C	F7	residual fraction	X-ray fluorescence analysis	
Fraction	chemical interpretation	extraction conditions	duration																																
F1	mobile	1 M NH ₄ NO ₃	24 hours																																
F2	easily mobilisable	1 M NH ₄ -acetate (pH 6)	24 hours																																
F3	bound to Mn-oxides	0.1 M NH ₂ OH-HCl + 1 M NH ₄ -acetate (pH 6)	30 min.																																
F4	bound to organic matter	0.025 M NH ₄ EDTA (pH 4.6)	90 min.																																
F5	bound to amorphous Fe-oxides	0.2 M NH ₄ -oxalate (pH 3.25)	4 hours in the dark																																
F6	bound to crystalline Fe-oxides	0.1 M ascorbic acid + 0.2 M NH ₄ -oxalate (pH 3.25)	30 min. at 96 °C																																
F7	residual fraction	X-ray fluorescence analysis																																	

Do's, don'ts, potential limitations, untested possibilities	<ul style="list-style-type: none"> • The method can be used for both polluted and non-polluted soils. • The results from a sequential extraction have to be evaluated with great care. Artefacts such as re-adsorption of extracted metals onto the soil material or precipitation of solid phases can result in high concentrations in the following extraction solution. • To date we have only used this method for bulk soil samples, but due to the small amount of sample needed (2 g), the method is also applicable to rhizosphere soil.
References	<p><i>The original method has been published only in German:</i></p> <p>Zeien, H. 1995. Chemische Extraktionen zur Bestimmung der Bindungsformen von Schwermetallen in Böden. Ph.D. dissertation. Friedrich-Wilhelms-Universität, Bonn.</p> <p>Zeien, H.; Brümmer, G. W. 1989. Chemische Extraktion zur Bestimmung von Schwermetallbindungsformen in Böden. Mittlg. Dtsch. Bodenkundl. Ges. 59: 505-510.</p> <p><i>A quite detailed English description with application to rhizosphere can be found in:</i></p> <p>Al-Najar, H.; Schulz, R.; Römheld, V. 2003. Plant availability of thallium in the rhizosphere of hyperaccumulator plants: a key factor for assessment of phytoextraction. Plant and Soil 249: 97-105.</p>

ID	22_Sas-Paszt
Author	Sas-Paszt, Lidia; Stepien, Teresa Research Institute of Pomology and Floriculture, Pomologiczna 18, 96-100 Skierniewice, Poland; lsas@insad.pl; ++48 46 8332021 ext. 235
Parameter	Soil pH; available contents of P, K, Mg and microelements
Soil type	Mineral soil from pomological orchards
Plant species	Strawberry, apple, pear
System	Soil from laboratory or field
Method	soil extracts: KCl (pH); lactate buffer (P, K); CaCl₂ (Mg); HCl (microelements)
Method description	<p><i>Preparation of the soil for analysis</i> A fresh, well-mixed soil sample needs to be air-dried at a temperature not exceeding 40°C. Put the air-dried soil through a sieve with 1 mm square holes. Place the sifted soil sample in a cardboard box, close and mark according to the adopted system of recording samples.</p> <p><i>Determination of pH</i> Soil reaction results from the concentration (activity) of hydrogen and hydroxide ions in the soil solution. The concentration of hydrogen ions is most commonly expressed as pH. The pH value measured in potassium chloride includes the concentration of hydrogen ions present in the soil solution as well as hydrogen ions weakly bound to the solid fraction of the soil. Using an analytical balance weigh out 10.0 g of the soil prepared earlier. Put this amount of soil into a 50 cm³ beaker. Add 25 cm³ of 1 M KCl solution. Mix the contents of the beaker with a glass rod. Carry out measurements after 24 hours.</p> <p><i>Determination of the available forms of phosphorus and potassium in mineral soil by means of the Egner-Riehm method</i> The Egner-Riehm method consists in extracting phosphorus and potassium compounds from the soil by means of a buffer solution. The extraction solution in this case is a mixture of lactic acid buffered by calcium lactate of pH 3.55. Weigh out 5.0 g of the soil prepared earlier and put it into a 300 or 500 cm³ bottle. Add 250 cm³ of the extraction solution. Mix the contents of the bottle for about 90 minutes on a rotary stirrer (40 r.p.m.), then filter into a conical flask through a dense quantitative filter (free of phosphorus and potassium), discarding the first portion of the filtrate. The filtrate obtained in this way is ready for analysis by means of inductively-coupled plasma optical emission spectrometry (ICP-OES).</p> <p><i>Determination of the available forms of magnesium in mineral soil using the Schachtschabel's method</i> The Schachtschabel's method consists of shaking the soil with 0.025 M calcium chloride. Calcium ions displace magnesium ions from sorption sites at the soil matrix and the Mg ions are thus transferred into the solution. Using an analytical balance weigh out 5.0 g of the soil prepared earlier. Put this amount of soil into a 100 cm³ conical flask and pour onto it 50 cm³ of the extraction solution (0.025 M CaCl₂). Stir the contents of the flask slightly and leave until the next day, or mix on a rotary stirrer for about 2 hours. Filter the contents</p>

	<p>into a 50 or 100 cm³ conical flask through a dense quantitative filter (free of magnesium), trying at the same time to transfer onto the filter as much soil as possible. Discard the first drops of the filtrate. The filtrate obtained in this way is ready for analysis by means of ICP-OES.</p> <p><i>Determination of the available forms of micro-elements in the soil</i> The available forms of micro-elements in the soil are determined by means of extraction with 1 M HCl. Using an analytical balance weigh out 5.0 g of the soil prepared earlier. Put this amount of soil into a 100 cm³ conical flask and pour onto it 50 cm³ of the extraction solution (1M HCl). Mix the contents of the flask on a rotary stirrer for about 60 minutes. Then filter the contents through a dense quantitative filter. Discard the first drops of the filtrate. The filtrate obtained in this way is ready for analysis by means of ICP-OES.</p>
Do's, don'ts, potential limitations, untested possibilities	To prepare extraction solutions use only reagent grade or even higher quality reagents and water with a high degree of purity.
References	<p>Szczepaniak W. 1997. Metody instrumentalne w analizie chemicznej. Wydawnictwo Naukowe PWN, Warszawa.</p> <p>Praca zbiorowa pod redakcją Stanisława Mercika, Chemia Rolna. Podstawy teoretyczne i praktyczne. Wydawnictwo SGGW, Warszawa 2002</p> <p>Procedury Badawcze Centralnego Laboratorium Analitycznego ISK, Skierniewice 2001.</p>
Additional information	Protocols for extractions and measurements (in Polish and English) available on request from the author

ID	22_Sinaj_a
Author	Sinaj, Sokrat ETH Zurich, Plant Sciences, Eschikon 33, 8315 Lindau (ZH), Switzerland sokrat.sinaj@ipw.agrl.ethz.ch; ++41 52 354 9149
Parameter	Bioavailability of P, Zn and Cd
Soil type	Temperate and tropical soils
System	Batch experiments with soil:water suspension
Method	Isotopic Exchange Kinetics (IEK; E-value)
Method description	A radiotracer (carrier-free) is injected in a pre-equilibrated soil suspension and its disappearance from the solution is observed over a relatively short time (60-100 minutes). The concentration of the stable element is measured at the end of the experiment. The amounts of element that are isotopically exchangeable for a given time are calculated assuming that: <ol style="list-style-type: none"> both the radioactive and the stable element have the same fate in the system, and at equilibrium, the Specific Activity (concentration ratio of radioactive isotope / stable isotope) of the element in soil solution is identical to that of the element at the soil matrix.
Do's, don'ts, potential limitations, untested possibilities	For P, problems may arise with soils with very low P concentration in solution and hence with a high P-fixing capacity, whereas for Zn and Cd for alkaline soils with very low available and total Zn and Cd.
References	<p><i>Description of the IEK method and its application to K, PO₄, SO₄ and Zn</i> Frossard, E.; Sinaj, S. 1997. Isot. Environ. Health Stud. 33: 61-77.</p> <p><i>Review on the use of isotopes for soil P dynamics</i> Fardeau, J.C. 1996. Fertilizer Res. 45: 91-100.</p> <p><i>Problems with tropical soils addressed and solved in</i> Bühler S.; Oberson, A.; Sinaj, S.; Friesen, D.K.; Frossard, E. 2003. Eur. J. Soil Sc. 54: 605-617.</p> <p><i>Soil isotopically exchangeable Zn</i> Sinaj, S; Mächler, F.; Frossard, E. 1999. Soil Sci. Soc. Am. J. 63: 1618-1625.</p> <p><i>Cadmium availability in soils using isotope techniques</i> Gray, C.W.; McLaren, R.G.; Günther, D.; Sinaj, S. 2004. Soil Sci. Soc. Am. J. 68: 1210-1217.</p> <p><i>Cadmium fixation in soils measured by isotope dilution</i> Smolders, E.; Brans, K.; Foldi, A.; Merckx, R. 1999. Soil Sci. Soc. Am. J. 63: 78-85</p>

ID	22_Sinaj_b
Author	Sinaj, Sokrat ETH Zurich, Plant Sciences, Eschikon 33, 8315 Lindau (ZH), Switzerland sokrat.sinaj@ipw.agrl.ethz.ch; ++41 52 354 9149
Parameter	Bioavailability of P, Zn and Cd
Soil type	Temperate and tropical soils
Plant species	Any
System	Pot / rhizobox experiments with plants grown in labeled soils
Method	Uptake of elements from radioactively labeled soils (L-values)
Method description	Plants are grown in soils previously labeled with the investigated radiotracer. Both the radioactive and the stable isotope of the element (isotopic composition) are measured in the plant material to assess the amount of isotopically exchangeable element in soil.
Do's, don'ts, potential limitations, untested possibilities	If the tested plant does not transform a significant amount of non-exchangeable element into exchangeable form, then the L and E values should be equal. For P, further dilution of the tracer taken up by the plant may be caused by the initial pool of seed P. To avoid significant contamination, P in the seeds should be an order of magnitude lower than P taken up by the plant.
References	<p><i>Uptake of P by plants</i> Larsen S. 1952. Plant Soil 4: 1-10.</p> <p><i>Zn and its uptake by plants</i> Tiller K. 1972. Austral. J. Soil Res. 10: 151-164.</p> <p><i>Comparisons of E and L values for P</i> Frossard, E.; Fardeau, J.C.; Brossard, M.; Morel, J.L. 1994. Soil Sci. Soc. Am. J. 58: 846-851.</p> <p><i>Comparisons of E and L values for Zn</i> Sinaj, S.; Dubois, A.; Frossard, E. 2004. Plant Soil, 261: 17-28.\$</p> <p><i>Comparisons of E and L values for Cd</i> Gerard, E.; Echevarria, G.; Sterckeman, T.; Morel, J.L. 2000. J. of Environ. Qual. 29: 1117-1123.</p> <p><i>Determination of Cd using isotopic dilution</i> Hutchinson, J.J.; Young, S.D.; McGrath, S.P.; West, H.M.; Black, C.R.; Baker, A.J.M. 2000. New Phytologist 146: 453-460.</p>

ID	22_Tappero
Author	Tappero, R.; Roberts, D.R.; Marcus, M.A.; Gräfe, M.; Sparks, D.L. Plant and Soil Sciences Dept., University of Delaware, Newark, DE 19717, USA; dlsparks@udel.edu, ++1 302 831 8153
Parameter	(<i>In situ</i>) Elemental distributions, associations, and molecular speciation in solid phases
Soil type	Techniques applicable to solid matrices
System	Material from field or laboratory systems
Method	Synchrotron X-ray fluorescence (μ-SXRF) imaging and X-ray absorption fine structure (XAFS) spectroscopy
Method description	<p><i>μ-SXRF imaging:</i> Soil samples (e.g., resin embedded thin sections) or solid materials are mounted onto an x,y sample stage positioned at 45° to a microfocused X-ray beam. The incident beam energy is fixed such that fluorescence signals from all elements of interest are simultaneously detected by a multi-element solid-state detector positioned at 90° to the incident beam. The sample is rastered in the beam path to generate a coarse map (typically 1 - 3 mm² map with 20 micrometer pixel resolution). Smaller step sizes (e.g., 5 micrometer) and longer dwell times can be used to optimize image resolution (fine map). The multi-element SXRF images are useful for observing (<i>in situ</i>) elemental distributions and associations in complex, heterogeneous systems at the micrometer scale (Fig. 1a).</p> <p><i>XAFS spectroscopy:</i> Soil samples mounted for SXRF imaging can be utilized for m-XAFS data collection. Points-of-interest (POIs) identified on the coarse and fine maps are selected for XAFS analysis, and spectra are collected from 200 eV below to 500 - 1000 eV above the designated edge energy (i.e., element specific). Data from the near-edge region (XANES) of the XAFS spectra can be used to investigate the oxidation state of redox-sensitive elements. Data reduction (i.e., background subtraction, normalization, chi extraction) of sample XAFS spectra (bulk and microfocused) and reference spectra is typically followed by principal components analysis (PCA) and linear least squares fitting (LLSF) to determine the primary components and their contribution to the set of sample spectra (Manceau et al., 2002). Molecular-scale information gleaned with XAFS is complemented by the multi-element SXRF images, and together they provide a detailed picture of <i>in situ</i> elemental distributions, associations, and molecular speciation in natural, heterogeneous systems (Fig 1a-d).</p>
Do's, don'ts, potential limitations, untested possibilities	<ul style="list-style-type: none"> • Soil thin sections (~30 mm) are well suited to SXRF imaging and XAFS, but care must be taken with redox-sensitive elements to avoid beam-induced reduction or oxidation (interaction with resin, adhesives, or soil organic matter), which can be minimized by decreasing temperature, photon density, or exposure time. Alternatively, soil samples can be mounted by collecting the solid onto a filter paper and then sealing the entire cake between Kapton tape. Sieved soil can be mounted directly onto Kapton by a powder-tapping technique, which involves covering the mouth of a small vial (containing the sample) with Kapton, inverting several times to coat the tape, and tapping residual material off the tape. • These methods do not resolve the elements having a lower atomic number than sulfur (e.g., oxygen, nitrogen, carbon, or organic fractions).

	<ul style="list-style-type: none"> Detection limits are beamline specific and dependent on the composition of the major constituents in the sample (range ~ 20 - 200 mg/kg). Predictions for future developments to this technology include improved spatial resolution, detection of lighter (lower Z) elements, and lower detection limits. Run time for most beamlines is limited and access is proposal driven and competitive. 																																																																																																														
References	<p>Fendorf, S.E.; Sparks, D.L.; Lamble, G.M.; Kelley, M.J. 1994. Applications of X-ray absorption fine structure spectroscopy to soils. <i>Soil Science Society of America J.</i> 58:1583-1595.</p> <p>Manceau, A.; Marcus, M.A.; Tamura, N. 2002. Quantitative speciation of heavy metals in soils and sediments by synchrotron X-ray techniques. In: Fenter, P.; Sturchio, N.C. (Eds.). <i>Applications of Synchrotron Radiation in Low-Temperature Geochemistry and Environmental Science, Reviews in Mineralogy and Geochemistry</i>, Mineralogical Society of America, Washington, DC, Vol. 49: 341-428.</p> <p>Nachtegaal, M.; M.A. Marcus; J.E. Sonke; J. Vangronsveld; D. van Der Lelie; D.L. Sparks. 2005. Effects of <i>in situ</i> remediation on the speciation and bioavailability of zinc in a smelter contaminated soil. <i>Geochim. et Cosmochim. Acta</i> 69:4649-4664.</p> <p>Roberts, D.R.; Scheinost, A.C.; Sparks, D.L. 2002. Zinc speciation in a smelter-contaminated soil profile using bulk and microspectroscopic techniques. <i>Environ. Sci. Technol.</i> 36:1742-1750.</p>																																																																																																														
Links	http://xraysweb.lbl.gov/uxas/Index.htm																																																																																																														
Additional information	Complementary method for plant analysis by SXRF and XAFS (see 21_Tappero).																																																																																																														
<p>a) m-SXRF images for Mn, Zn, and Fe. The Zn image shows three spots labeled 1, 2, and 3. A 40 μm scale bar is present.</p> <p>b) Zn-XAFS k^3-weighted χ and corresponding Fourier transforms. The left plot shows $\chi(k)$ vs k (Å⁻¹) from 2 to 10. The right plot shows Fourier transforms $R(R)$ vs R (Å) from 0 to 8. Curves are labeled: Surface Spot 1, Surface Spot 2, Subsurface Spot 1 (Zn-Al), Subsurface Spot 2 (Zn-Fe), and Subsurface Spot 3 (Zn-Fe/Mn).</p> <p>c) m-XAFS parameters for soil samples.</p> <table border="1"> <thead> <tr> <th rowspan="2">sample</th> <th colspan="4">first shell</th> <th colspan="4">second shell</th> </tr> <tr> <th>atom</th> <th>CN^{a,d}</th> <th>R (Å)^{b,e}</th> <th>σ^2 (Å²)^f</th> <th>atom</th> <th>CN^g</th> <th>R (Å)^h</th> <th>σ^2 (Å²)</th> </tr> </thead> <tbody> <tr> <td>surface - spot 1^h</td> <td>Zn-O</td> <td>4.0</td> <td>1.97</td> <td>0.0079</td> <td>Zn-Fe/Zn</td> <td>13.2</td> <td>3.52</td> <td>0.0091</td> </tr> <tr> <td>surface - spot 2</td> <td>Zn-O</td> <td>4.1</td> <td>1.98</td> <td>0.0070</td> <td>Zn-Fe/Zn</td> <td>8.1</td> <td>3.51</td> <td>0.0100</td> </tr> <tr> <td>subsurface - spot 1ⁱ</td> <td>Zn-O</td> <td>5.6</td> <td>2.04</td> <td>0.0049</td> <td>Zn-Al</td> <td>1.5</td> <td>3.01</td> <td>0.005^j</td> </tr> <tr> <td>subsurface - spot 2</td> <td>Zn-O</td> <td>5.1</td> <td>2.00</td> <td>0.005^j</td> <td>Zn-Fe</td> <td>1.9</td> <td>3.25</td> <td>0.005^j</td> </tr> <tr> <td>subsurface - spot 3</td> <td>Zn-O</td> <td>3.4</td> <td>1.98</td> <td>0.005^j</td> <td>Zn-Fe/Mn</td> <td>1.4</td> <td>3.45</td> <td>0.005^j</td> </tr> </tbody> </table> <p>^a Coordination number. ^b Interatomic distance. ^c Debye-Waller factor. ^d Fit quality limits for parameters: ±20%. ^e ± 0.02 Å. ^f ± 40%. ^g ± 0.05 (%).</p> <p>d) Linear combinations of fit results for soil samples.</p> <table border="1"> <thead> <tr> <th rowspan="2"></th> <th colspan="6">Zn (%)</th> </tr> <tr> <th>ZnFe₂O₄</th> <th>ZnS</th> <th>Zn-ferrhydrite</th> <th>Zn-birnessite</th> <th>Zn-gibbsite</th> <th>Zn-aq</th> </tr> </thead> <tbody> <tr> <td>surface, spot 1</td> <td>100</td> <td>0</td> <td>0</td> <td>0</td> <td>0</td> <td>0</td> </tr> <tr> <td>surface, spot 2</td> <td>85</td> <td>0</td> <td>15</td> <td>0</td> <td>0</td> <td>0</td> </tr> <tr> <td>subsurface, spot 1</td> <td>0</td> <td>0</td> <td>15</td> <td>0</td> <td>50</td> <td>35</td> </tr> <tr> <td>subsurface, spot 2</td> <td>0</td> <td>0</td> <td>40</td> <td>0</td> <td>15</td> <td>45</td> </tr> <tr> <td>subsurface, spot 3</td> <td>0</td> <td>0</td> <td>35</td> <td>25</td> <td>15</td> <td>25</td> </tr> </tbody> </table>		sample	first shell				second shell				atom	CN ^{a,d}	R (Å) ^{b,e}	σ^2 (Å ²) ^f	atom	CN ^g	R (Å) ^h	σ^2 (Å ²)	surface - spot 1 ^h	Zn-O	4.0	1.97	0.0079	Zn-Fe/Zn	13.2	3.52	0.0091	surface - spot 2	Zn-O	4.1	1.98	0.0070	Zn-Fe/Zn	8.1	3.51	0.0100	subsurface - spot 1 ⁱ	Zn-O	5.6	2.04	0.0049	Zn-Al	1.5	3.01	0.005 ^j	subsurface - spot 2	Zn-O	5.1	2.00	0.005 ^j	Zn-Fe	1.9	3.25	0.005 ^j	subsurface - spot 3	Zn-O	3.4	1.98	0.005 ^j	Zn-Fe/Mn	1.4	3.45	0.005 ^j		Zn (%)						ZnFe ₂ O ₄	ZnS	Zn-ferrhydrite	Zn-birnessite	Zn-gibbsite	Zn-aq	surface, spot 1	100	0	0	0	0	0	surface, spot 2	85	0	15	0	0	0	subsurface, spot 1	0	0	15	0	50	35	subsurface, spot 2	0	0	40	0	15	45	subsurface, spot 3	0	0	35	25	15	25
sample	first shell				second shell																																																																																																										
	atom	CN ^{a,d}	R (Å) ^{b,e}	σ^2 (Å ²) ^f	atom	CN ^g	R (Å) ^h	σ^2 (Å ²)																																																																																																							
surface - spot 1 ^h	Zn-O	4.0	1.97	0.0079	Zn-Fe/Zn	13.2	3.52	0.0091																																																																																																							
surface - spot 2	Zn-O	4.1	1.98	0.0070	Zn-Fe/Zn	8.1	3.51	0.0100																																																																																																							
subsurface - spot 1 ⁱ	Zn-O	5.6	2.04	0.0049	Zn-Al	1.5	3.01	0.005 ^j																																																																																																							
subsurface - spot 2	Zn-O	5.1	2.00	0.005 ^j	Zn-Fe	1.9	3.25	0.005 ^j																																																																																																							
subsurface - spot 3	Zn-O	3.4	1.98	0.005 ^j	Zn-Fe/Mn	1.4	3.45	0.005 ^j																																																																																																							
	Zn (%)																																																																																																														
	ZnFe ₂ O ₄	ZnS	Zn-ferrhydrite	Zn-birnessite	Zn-gibbsite	Zn-aq																																																																																																									
surface, spot 1	100	0	0	0	0	0																																																																																																									
surface, spot 2	85	0	15	0	0	0																																																																																																									
subsurface, spot 1	0	0	15	0	50	35																																																																																																									
subsurface, spot 2	0	0	40	0	15	45																																																																																																									
subsurface, spot 3	0	0	35	25	15	25																																																																																																									

ID	22_Turpault
Author	Turpault, Marie-Pierre UR INRA Biogéochimie des Ecosystèmes Forestiers, F-54280 Champenoux, France turpault@nancy.inra.fr ; ++33 3 83 39 40 75
Parameter	Quantitative mineralogy of rhizosphere soil
Soil type	Acid forest soils
Plant species	A mono-species stand of any forest species
System	Field soil
Method	Multistep procedure performed on particle size fractions
Method description	<p>The method is based on normative calculations from the total chemical composition of the sample and the real chemical composition of the soil minerals. After rhizosphere soil sampling (see 13_Turpault), the organic matter was removed by H₂O₂ and the particle size fractions were separated by sedimentation (Robert and Tessier, 1974). The method of quantitative mineralogy involved 7 stages:</p> <ol style="list-style-type: none"> 1. The chemical composition of the particle size fractions was obtained by inductively-coupled plasma optical emission spectrometry (ICP / OES) after saturation with a cation present in low amounts in the sample, e.g. Sr or Ba followed by fusion with LiBr and dissolution in 1 M HCl. 2. The short-range ordered minerals (SROs) were extracted with different reagents, e.g. oxalate (Schwertmann, 1964), dithionite-citrate-bicarbonate (Mehra and Jackson, 1960) or Na-citrate (Tamura, 1957). The amounts of extractable elements were subtracted from the bulk chemical composition of the sample. 3. Minerals were identified by X-ray diffraction and microscopy. Clay minerals were identified after Ca-saturation followed by ethylene-glycol solvation, and K-saturation followed by heating to 110, 330 and 550°C before and after Na-citrate treatment. 4. The effective chemical composition of each mineral was determined using thin sections of the sand fraction using a microprobe or scanning electron microscope equipped with an energy-dispersive detector (EDX), or directly from the clay or silt fraction using a transmission electron microscope with an EDX analyser, after a treatment which removed the SROs, and Sr or Ba saturation. The number of analyses (n) had to be adjusted according to the variability of the chemical analyses (n=15 as a minimum for minerals; n > 50 for mixed-layer phyllosilicates). 5. If the sample contained gibbsite or kaolinite, the percentages of these minerals were determined by differential thermal analysis. The amounts of gibbsite and kaolinite were calculated from the weight loss during thermal analysis between 220-320°C and 350-550°C, respectively (Jackson, 1956; Mackenzie, 1970). The amount of elements in gibbsite or kaolinite was subtracted from the bulk chemical composition of the sample. 6. If a chemical element was only in one mineral, the amount of this mineral could be deduced from the amount of the element. For example, the amount of apatite is frequently deduced from the percentage of P₂O₅ in the sample. In this case, the amount of Ca in apatite was subtracted from the bulk chemical composition of the sample. 7. The variables (chemical elements) chosen to characterise the mineral in the system of equations had to be principal elements contained in the mineral. Generally, the major elements chosen were: Al₂O₃, K₂O, MgO or Na₂O. Mineral quantification was based on an x-linear equation to calculate the percentage of x minerals in the sample.

	<p>For example for 4 minerals, it was necessary to solve the system of 4 equations:</p> $\text{Al}_2\text{O}_{3t} = a \text{Al}_2\text{O}_{3M1} + b \text{Al}_2\text{O}_{3M2} + c \text{Al}_2\text{O}_{3M3} + d \text{Al}_2\text{O}_{3M4}$ $\text{K}_2\text{O}_t = a \text{K}_2\text{O}_{M1} + b \text{K}_2\text{O}_{M2} + c \text{K}_2\text{O}_{M3} + d \text{K}_2\text{O}_{M4}$ $\text{MgO}_t = a \text{MgO}_{M1} + b \text{MgO}_{M2} + c \text{MgO}_{M3} + d \text{MgO}_{M4}$ $\text{Na}_2\text{O}_t = a \text{Na}_2\text{O}_{M1} + b \text{Na}_2\text{O}_{M2} + c \text{Na}_2\text{O}_{M3} + d \text{Na}_2\text{O}_{M4}$ <p>where O_t, O_{M1}, O_{M2}, O_{M3} and O_{M4} are the oxide in the total sample (after subtracting any contributions from stages 2, 5 and 6), and the oxide O in minerals 1, 2, 3 and 4, respectively. a, b, c and d were the percentages of minerals 1, 2, 3 and 4 to be determined.</p>
<p>Do's, don'ts, potential limitations, untested possibilities</p>	<p>The procedure of quantifying soil minerals is time consuming but it can be standardised by taking some precautions, and it has some limitations. There are three important limitations:</p> <ol style="list-style-type: none"> 1. if the number of minerals in the sample is higher than the number of variables; 2. if the chemical composition distribution of the interstratified minerals is too large to define its mean chemical composition; 3. if the minerals occurring in the sample are not characterised accurately by one variable. <p>The principal recommendations when using this procedure to quantify minerals in soil are :</p> <ol style="list-style-type: none"> 1. to divide the soil into different particle size fractions if the mineral type distribution depends on these fractions to limit the number of variables; 2. to choose the chemical treatment carefully to remove SROs; 3. to determine the mean chemical composition of phyllosilicates after this treatment, and 4. to choose appropriate variables.
<p>References</p>	<p>Fichter, J.; Bonnaud, P.; Turpault, M.-P.; Ranger, J. 1998. Quantitative determination of minerals in acid forest soils. <i>Z. Pflanzenernähr. Bodenk.</i> 161: 129-139.</p> <p>Fichter, J.; Turpault, M.-P.; Dambrine, E.; Ranger, J. 1998. Localization of base cations in particle size fractions of acid forest soils (Vosges mountains, N-E France). <i>Geoderma</i> 82: 295-314.</p> <p>Jackson, M.L. 1956. Soil chemical analysis advanced course. Univ. of Wisconsin. Madison, 991p.</p> <p>Mackenzie, R.C. 1970. Differential thermal analysis. Vol. I. Fundamental aspects. Acad. Press. London & New York, 775p.</p> <p>Mehra, O.P.; Jackson, M.L. 1960. Iron oxide removal from soils and clays by a dithionite-citrate system buffered with sodium bicarbonate. <i>Clays Clay Miner.</i> 7: 317-327.</p> <p>Robert, M.; Tessier, D. 1974. Méthode de préparation des argiles des sols pour des études minéralogiques. <i>Ann. agron.</i> 25: 859-882.</p> <p>Schwertmann, U. 1964. Differenzierung der Eisenoxide des Bodens durch Extraktion mit Ammoniumoxalatlösung. <i>Z. Pflanzenernähr. Bodenk.</i> 105, 194-202.</p> <p>Tamura, T. 1958. Identification of clay minerals from acid soils. <i>J. Soil Sci.</i> 9: 141-147.</p>

ID	22_Zimmermann_a
Author	Zimmermann, Stephan ¹⁾ ; Zwicky, Christoph N. ²⁾ ; Pezzotta, Daniele ¹⁾ ; Lienemann, Peter ²⁾ ; Blaser, Peter ¹⁾ ; Luster, Jörg ¹⁾ ¹⁾ Swiss Federal Institute for Forest, Snow, and Landscape Research, WSL, CH-8903 Birmensdorf, Switzerland stephan.zimmermann@wsl.ch; +41 44 739 22 66 ²⁾ Swiss Federal Laboratories for Materials Testing and Research EMPA, Inorganic Analytical Chemistry, CH-8600 Duebendorf, Switzerland; peter.lienemann@empa.ch
Parameter	Total and total extractable element contents in soil
Soil type	Acid and calcareous forest soils
Method	XRF of powder and fused discs; HNO₃ extracts
Method description	<p><i>XRF analysis:</i> Soil samples can be analysed by wavelength-dispersive X-ray fluorescence spectrometry (WD-XRF) as loose powders or fused beads. Fused beads are used to analyze major and minor components. Loose powders are used to determine trace elements and elements which tend to get lost due to high temperature when fusing a bead.</p> <p><i>Sample preparation for XRF analysis:</i> <i>Powder:</i> The dried (60°C) and sieved (< 2 mm) soil samples are ground to a fine powder (< 45 µm) in a vibrating cup mill of tungsten carbide. <i>Fused beads:</i> The loss on ignition is determined in two steps: 1h at 500°C and further 2h at 975°C. The fusion is accomplished by mixing fine powder of the soil sample with the flux (Li₂B₄O₇) and heating the mixture to a high temperature (soil + Li₂B₄O₇: 1g + 5g; 5 min.; 1200°C).</p> <p><i>HNO₃ extract:</i> Extraction of dried and sieved (< 2 mm) soil samples with 2 M HNO₃ in a boiling water bath (soil:extractant 1:10; 2 h; 94-97°C; horizontal shaking). Filtration of the hot extract and determination of metal concentrations in the filtered extract by inductively-coupled plasma optical emission spectrometry (ICP / OES).</p> <p><i>Calculation of Enrichment Factors (with XRF data):</i> Theoretical lithogenic metal contents are calculated relative to Zr as an immobile reference: $[M]_{\text{lithogenic, layer x}} = [\text{Zr}]_{\text{layer x}} / [\text{Zr}]_{\text{bed rock}} \times [M]_{\text{bed rock}}$ Enrichment factors are then calculated from measured and theoretical lithogenic metal contents: $EF = [M]_{\text{measured, layer x}} / [M]_{\text{lithogenic, layer x}}$</p>
Do's, don'ts, potential limitations, untested possibilities	<p><i>HNO₃ extraction:</i> This procedure results in an approximation of the total element content. The efficiency of the extractant depends on the mineralogy of the soil and of the particle size of the various minerals. In calcareous soils, the HNO₃-extractable contents are close to the contents determined by XRF, whereas in soils developed on crystalline bed rock with a high content of poorly weatherable minerals, the efficiency is low.</p> <p><i>WD-XRF:</i></p> <ul style="list-style-type: none"> This is a surface-specific method with the analysed area of the sample having a diameter of 25 mm. The depth from where chemical information

	<p>is obtained is element specific and matrix dependent. When analysing solids, the penetration depth is in the micrometer range. In the case of powder samples, the analytical results are therefore affected by differing particle size.</p> <ul style="list-style-type: none"> • The method does not detect elements having an atomic number lower than sodium, such as oxygen, nitrogen, carbon and boron, or organic fractions. • The detection limit is dependent on the chemical composition of the major constituents of the sample and is in the range of 10-100 mg/kg. • Matrix-dependent element sensitivity is taken into account by including theoretical sensitivity factors in the quantitative calculation procedure. Although the evaluation is performed standardless in the range between 0.01 and 100%, the so-called "semi-quantitative" analytical method may be considered quantitative, with relative errors in the major and minor elements in the range below 5% for homogeneous glass beads. • In the case of powder samples deviations in the order of 10-20% have to be expected. The systematic error is attributable to the unknown weight fractions of the unmeasured, i.e. undetected, light elements such as oxygen and carbon, which must be included in the calculation procedure. • Due to the very high precision of WD-XRF analysis, samples, which have a similar chemical composition and contain major and minor elements in approximately identical proportions, show correctly reproduced relative differences in the mass content.
References	<p><i>XRF analysis:</i> Karathanasis, A.D.; B.F. Hajek, 1996. In: Sparks, D.L. (ed.) Methods of Soil Analysis. Part 3. Chemical Methods. SSSA Book Series No. 5., pp. 161-223.</p> <p>Potts, P.J. 1992. A Handbook of Silicate Rock Analysis. Blackie & Son Ltd, Glasgow and London, 622 pp.</p> <p><i>HNO₃ extract:</i> Aitang, H.; Häni, H. 1983. J. Plant Nutr. Soil Sci. 146: 481-493.</p> <p>Andersson, A. 1975. Swedish J. agric. Res. 5: 125–135.</p> <p><i>Calculation of Enrichment Factors (from XRF data, but somewhat different XRF methodology)</i> Blaser, P.; Zimmermann, S.; Luster, J.; Shotyk, W. 2000. Critical examination of trace element enrichments and depletions in soils: As, Cr, Cu, Ni, Pb, and Zn in Swiss forest soils. Sci. Total Environ. 249: 257-280.</p> <p><i>Estimation of long-term mobility of trace elements in Swiss forest soils based on enrichment factors; anthropogenic and lithogenic "contamination" of Swiss forest soils based on HNO₃-extractable contents:</i> Luster, J.; Zimmermann, S.; Zwicky, C.N.; Lienemann, P.; Blaser, P. 2006. Heavy metals in Swiss forest soils: modification of lithogenic and anthropogenic contents by pedogenetic processes and implications for ecological risk assessment. In: Frossard, E.; Blum, W.E.H.; Warkentin, B.; Wolf, U. (eds.). Function of soils for human societies and the environment. Geological Society, London, Special Publications 266: 63-78.</p>

ID	22_Zimmermann_b
Author	Zimmermann, Stephan; Blaser, Peter; Luster, Jörg Swiss Federal Institute for Forest, Snow and Landscape Research WSL, CH-8903 Birmensdorf, Switzerland stephan.zimmermann@wsl.ch; ++41 44 739 22 66
Parameter	Pedogenic oxides
Soil type	Acid and calcareous forest soils
Method	Total Fe oxides by dithionite/citrate extraction Amorphous Fe and Al oxides by oxalate extraction Organically bound Fe and Al by pyrophosphate extraction
Method description	<p><i>Sample preparation:</i> Soil samples are dried at 60°C and sieved to obtain fine earth < 2 mm.</p> <p><i>Dithionite/citrate extract:</i> Extraction with 0.07 M Na-Dithionite / 0.3 M Na-Citrate, buffered at pH ≈ 7 with 1 M NaHCO₃ (soil : extractant 1 : 80; 24 h; 20°C). Determination of the Fe-concentration in the filtered extract by atomic absorption spectrometry (AAS).</p> <p><i>Oxalate extract:</i> Extraction buffered at pH 3 with a solution which is 0.113 M in NH₄-Oxalate and 0.086 M in Oxalic acid (soil : extractant 1 : 50; 4 h; 20°C; in darkness to prevent photoreduction). Determination of the Al- and Fe-concentrations in the filtered extract by AAS.</p> <p><i>Pyrophosphate extract:</i> Extraction with 0.1 M Na-Pyrophosphate (soil : extractant 1 : 50; 16 h; 20°C). The extractant has a pH of about 10. Determination of the Al- and Fe-concentrations in the centrifuged and filtered extract by AAS.</p>
Do's, don'ts, potential limitations, untested possibilities	<p><i>Analysis of extracts by atomic absorption spectrometry (AAS):</i> The extracts have a high salt concentration and therefore tend to clog the burner head of the spectrometer. It is recommended to aspirate deionized water for at least 20 s between the samples.</p> <p><i>Interpretation of extracted Fe and Al:</i></p> <ul style="list-style-type: none"> • These selective dissolution procedures are operationally defined. Extracted contents are not an accurate measure of a specific fraction of Al or Fe, since none of the procedures is absolutely selective for the specific phases for which they are intended. • The dithionite/citrate extraction is thought to assess total or "free", reducible iron oxides. Dithionite is a strong reductant and reduces Fe³⁺ in oxides to Fe²⁺ at pH values below 10. To prevent the decomposition of dithionite to hydrogen sulfite and a decrease in pH, citrate is used to chelate dissolved Fe²⁺ and NaHCO₃ buffers the solution near pH 7. The dissolution efficiency is affected by particle size. Large crystals of magnetite, goethite and hematite may not be completely dissolved. Furthermore, the extracts will include small contributions from water-soluble, exchangeable, organically bound and structural Fe in layer silicates. Nevertheless, the amounts of iron oxides extracted using dithionite have been shown to correlate well with the amounts of iron

	<p>oxides determined with X-ray diffraction.</p> <ul style="list-style-type: none"> • The oxalate extraction intends to dissolve "active" aluminum- and iron oxides (also called "poorly crystalline", "short-range ordered" or "amorphous"). These oxides are small in size, have a high surface area and consequently are the most reactive oxides in the soil (e.g. ferrihydrite-like minerals, imogolite and allophane-like minerals). Each of the Al- and Fe-oxides will react with oxalate to some extent, but the reactions proceed at considerably different rates which depend on particle size and surface reactivity. Therefore, the extraction is kinetically controlled and the quantity of Al and Fe extracted is strongly dependent on reaction time, temperature and shaking intensity. The preferential dissolution of poorly crystalline oxides has been confirmed by differential X-ray diffraction. Calcareous soil samples have to be pretreated to remove CaCO₃ (CaCO₃ reacts with oxalic acid => change of the pH, and precipitation of Ca-oxalate). • The Pyrophosphate extraction is an approach to obtain the organically bound amounts of Al and Fe. The interpretation of the results is to some extent ambiguous, due to some severe problems with this procedure. Pyrophosphate disperses microcrystalline oxides which often are mixed or possibly coated with organic matter. It is not clear whether these oxide/organic-matter complexes were originally present in the soil or formed during the extraction procedure. Because of this dispersion phenomenon, results are highly dependent on the centrifugation and filtration procedure. Do not overextend the interpretation of the results!
References	<p><i>Overview:</i> Loeppert, R.H.; W.P. Inskeep, 1996. Iron. In: Sparks, D.L. (ed.) Methods of Soil Analysis. Part 3. Chemical Methods. SSSA Book Series No. 5. pp. 639-664.</p> <p><i>Dithionite/citrate (original method):</i> Mehra, O.P.; Jackson, M.L. 1960. In: Swineford, A. (ed.). Clays and Clay Minerals, Proceedings of the 7th National Conference, Washington D.C. 1958; pp. 317-327.</p> <p><i>Oxalate (original method):</i> Schwertmann, U. 1964. J. Plant Nutr. Soil Sci. 105: 194-202.</p> <p><i>Pyrophosphate (K-Pyrophosphate in place of Na-Pyrophosphate):</i> Bascomb, C.L. 1968. J. Soil Sci. 19: 251-268. Loveland, P.J.; Digby, P. 1984. J. Soil Sci. 35: 243-250.</p>

ID	23_Boudot
Author	Boudot, J.-P. CNRS, LIMOS - UMR 7137, Université Henri Poincaré Nancy I, Faculté des Sciences, Boulevard des Aiguillettes, BP 239, F-54506 - Vandoeuvre-lès-Nancy Cedex, France jean-pierre.boudot@limos.uhp-nancy.fr ; ++33 3 83 68 42 88;
Parameter	Al speciation in soil solutions
Soil type	acid soils
System	Soil solutions obtained by micro-suction cups
Method	Complete speciation scheme involving fast reaction with 8-hydroxyquinoline, ion chromatography, determination of total Al concentrations, and equilibrium calculations
Method description	<p><i>Flash extraction procedure of Al by 8-hydroxyquinoline:</i></p> <p>The inorganic monomeric species of Al are all quantitatively extracted using the following procedure, with the exception of the Al-F complexes which are not at all recovered. This extracted Al pool involves the following monomeric species: Al^{3+}, $\text{Al}(\text{OH})_n^{3-n}$, $\text{Al}(\text{Cl})_n^{3-n}$, $\text{Al}(\text{SO}_4)_n^{3-2n}$, AlPO_4°, AlHPO_4^+, $\text{AlH}_2\text{PO}_4^{2+}$, $\text{AlOHSi}(\text{OH})_4^{2+}$ and $\text{Al}(\text{OH})_4\text{Si}(\text{OH})_4^-$.</p> <ul style="list-style-type: none"> • Add 500 μl ultra pure water in a 14 ml polyethylene culture tube. • Add 200 μl of a 1 % 8-hydroxyquinoline solution (i.e. 10 g dissolved in 20 ml of glacial acetic acid, then adjusted to 1 L with ultra pure water). • Add 200 μl of a 1 M Na acetate solution containing 10 g L^{-1} of 1,10-orthophenanthroline and 35 g L^{-1} of hydroxylamine chlorhydrate. • Add 0.5 to 1 ml of the sample to be analysed forcefully by a piston pipette, taking care to assure sufficient turbulences to achieve a complete mixing of the sample with the buffered 8-hydroxyquinoline. • Stop the reaction by immediately and forcefully inject 4.5 ml of 4-Methyl-2-pentanone (MIBK) with a second pre-filled piston pipette. Strong turbulence is required to achieve most of the extraction of the Al-quinolinate. The end of this injection must be terminated 5 seconds after the beginning of the injection of the sample in the buffered 8-hydroxyquinoline. • Immediately, cap the tube and achieve the extraction of Al-quinolinate by shaking it vigorously for up to 15 seconds. • Read the absorbance of the MIBK phase in the dual mode both at 390 nm and 600 nm, and retain the difference between them. • Blank and standards must be analysed similarly to the unknown water samples and strictly at the same temperature. The calibration curve, which is strongly dependent of the temperature of the standards, appears to be almost linear in the range 0–1.5 $\text{mg}\cdot\text{L}^{-1}$ but fits better to a second order polynomial curve with higher Al concentrations. • Organic molecules (low amounts) that were extracted by the MIBK induce both a shift in the baseline of the absorption spectrum and a broad absorption between 600 and 390 nm. No absorbance over the baseline was observed at 600 nm and 390 nm, however, so that this interference is easily corrected by subtracting the absorbance at 600 nm from that at 390 nm.

	<ul style="list-style-type: none"> Each species of Al extracted by the procedure described above can be conveniently individually determined by equilibrium calculations with various chemical equilibrium programs, entering the extracted Al under "total Al" and allowing the formation of the extractable species only. Total concentrations of all other elements are also to be entered in the computation in order to maintain the control of the ionic strength on speciation. <p><i>Determination of the Al-F species:</i> As F has a much stronger affinity for Al than organic ligands, the Al-F species may be determined by chemical equilibrium calculations with not more than 0 to 20 % uncertainty, depending of the pH. Uncertainties arise from the modelling of organic Al. The WHAM 6 and VISUAL MINTEQ softwares are recommended in this respect.</p> <p><i>Determination of total monomeric versus polymeric/colloidal Al:</i> Total monomeric Al, both inorganic and organic, is recovered by ion chromatography using a Dionex CS-3 cationic column coupled to a post-column detector using Tiron. This method is not suitable for the overall speciation of monomeric Al in natural waters, owing to both the occurrence of some redistribution between species during chromatography and the frequent co-elution of both organic Al and Al-F species. Unrecovered Al is regarded as being of polymeric and/or colloidal nature.</p> <p><i>Determination of the organic Al species:</i> Organic Al is equal to total Al minus the Al recovered by the 8-hydroxyquinoline, minus the Al-F complexes and minus the Al unrecovered by ion chromatography.</p>
Do's, don'ts, potential limitations, untested possibilities	<ul style="list-style-type: none"> Works well for natural waters. The repeatability of the extraction step is usually $\pm 5\%$. Interferences: As, Cd, Co, Cr, Cu, Pb, Sc, Sb, Se, Sn, Y and Zn create no detectable interference at the level of $500 \mu\text{g L}^{-1}$, nor does Mn at the level of 100mg L^{-1}. The interference originating from Fe, if any, is corrected by subtracting the absorbance at 600 nm from that at 390 nm. Silver creates significant interferences over $250 \mu\text{g L}^{-1}$ and Mo over $100 \mu\text{g L}^{-1}$. Stronger interferences arise from the occurrence of more than $50 \mu\text{g L}^{-1}$ Ni, $8 \mu\text{g L}^{-1}$ Ti or $5 \mu\text{g L}^{-1}$ V.
References	<p>Boudot, J.-P.; Merlet, D.; Rouiller, J.; Maitat, O. 1994. Validation of an operational procedure for aluminium speciation in soil solutions and surface waters. <i>The Science of the Total Environment</i> 158: 237-252.</p> <p>Boudot, J. P.; Maitat, O.; Merlet, D.; Rouiller, J. 1996. Occurrence of non-monomeric species of aluminium in undersaturated soil and surface waters: consequences for the determination of mineral saturation indices. <i>Journal of Hydrology</i> 177: 47-63.</p> <p>Maitat, O.; Boudot, J. P.; Merlet, D.; Rouiller, J. 2000. Aluminium chemistry in two contrasted acid forest soils and headwater streams impacted by acid deposition, Vosges mountains, N.E. France. <i>Water, Air and Soil Pollution</i> 117: 217-243.</p>
Links	<p>Favourite softwares for equilibrium calculations: MINEQL+, WHAM 6 and VISUAL MINTEQ, at:</p> <p>http://www.mineql.com/homepage.html http://www.ife.ac.uk/Aquatic_Processes/wham/ http://www.lwr.kth.se/english/OurSoftware/Vminteq/index.htm#download</p>

ID	23_Cattani
Author	Cattani, I.; Capri, E.; Boccelli, R.; Fragoulis, G. Istituto di Chimica Agraria ed Ambientale, sez. Vegetale, UCSC, 29100 Piacenza, Italy ilenia.cattani@unicatt.it; ++39 523 599218
Parameter	Available and soluble Cu in soils, available and soluble (total and labile) As, pH of rhizosphere soil solution
Soil type	calcareous sandy soil (Cu), clayey soil (As)
Plant species	Zea mays (Cu), Pteris cretica (As)
System	rhizoboxes (Cu), lysimeters (As)
Method	DGT, rhizon soil solution sampler
Method description	<p><i>DGT measurement</i> is performed in a collected soil sample. The soil is brought into contact with the DGT device in laboratory. DGT devices are deployed in pots in replicate and at different hourly intervals, from 1 hours to several days. The mass of soil used should be at least 100 g. Soil moisture is kept at 80% of WHC and readjusted daily. All experiments are conducted at uniform temperature (preferably in thermostat). Copper or arsenic bound by DGT resins (Chelex-100 or Fe-ox respectively) may be measured by ICP-OES, following acid microwave assisted digestion (see also 23_Zhang_b for sample preparation, DGT deployment and analysis). DGT performance (the mean recovery of Cu or As by DGT in a spiked solution) may be also evaluated, according to the method used by Zhang and Davison (1995).</p> <p><i>Rhizon soil solution samplers</i> (Rhizosphere Research Products, Wageningen, The Netherlands) are used to extract soil solution from each soil pot, in replicate. The 5 cm sampler is inserted into each soil pot during filling and it is connected by a syringe needle with a 10 ml glass vacuum tube, in order to extract the soil pore water by vacuum. The soluble Cu and As (Cu_{sol} and As_{sol}) are measured using ICP-OES, following nitric acid-hydrochloric acid microwave assisted digestion.</p> <p><i>The dynamic numerical model of DGT-induced fluxes in soils</i> (DIFS) (Harper et al., 2000), may be used to calculate the the pool sizes of labile metal in the soil system, the distribution coefficient for labile metal and the response time of the solid phase/solution equilibrium. The ratio $R = Cu_{DGT}/Cu_{sol}$ represents the ability of the soil to resupply local pore water concentrations. R may be calculated and K_d and T_c may be derived from the best model fit of plots of R versus deployment time.</p> <p><i>Use of DGT and rhizon soil solution samplers in the rhizosphere:</i> DGT technique coupled with rhizon soil sampler may enable to measure the bioavailability of Cu in the rhizosphere of a vineyard soil, containing a Cu tolerant plant grown in a rhizobox and the bioavailability of As in the rhizosphere of a polluted agricultural soil, containing an As hyperaccumulator plant grown in a lysimeter. In the rhizobox, the 2-mm section of soil close to the root compartment (rhizosphere) may be separated from the remaining soil (bulk soil) using a slicing device (Fitz et al., 2003). pH, Cu_{sol} and Cu_{DGT} are measured in samples of both the rhizosphere and bulk soil. As the weight of the collected rhizosphere is only approximately 35 g, soil solution could be extracted by centrifugation, and DGT experiment may be performed for 24 h using an</p>

	<p>acrylic plate adaptor.</p> <p>In the lysimeter, the soil close to the root may be collected and separated from the bulk soil by hand. pH, As_{sol} and As_{DGT} are measured in samples of both the rhizosphere and bulk soil, by rhizon soil solution samplers and DGT respectively. Soil solution and DGT gel are digested and analyzed as previously described.</p>
Do's, don'ts, potential limitations, untested possibilities	<ul style="list-style-type: none"> • Rhizon soil solution samplers may adsorb Cu and probably As, especially under alkaline and low DOC conditions (see also 13_Luster). • Rhizon soil solution samplers can't be deployed if the weight of the soil sample is little, like for a soil layer separated from the bulk soil • DGT and rhizon soil solution sampler deployment could show some difficulties in soil with high clay content (for instance, metal flux could be altered). • Cu and As measurement by ICP spectrometry need a volume of 10 ml at least: dilution in the case of elution or acid digestion (DGT or soil solution samples) may lower the concentration below the detection limit. • Free Cu concentration should be measured in soil solution by the specific electrode, to distinguish between available and not available Cu. • Measurement of redox potential in soil solution could allow to distinguish between arsenite and arsenate, to help the interpretation of the results concerning the mobility and the speciation in rhizosphere and bulk soil
References	<p><i>Description of or references for all methods, example of results with interpretation:</i></p> <p>Cattani, I.; Fragoulis, G.; Boccelli, R.; Capri, E. 2006. Copper bioavailability in the Zea mays rhizosphere of two Italian soils. Chemosphere 64: 1972-1979.</p> <p>Cattani, I.; Capri, E.; Boccelli, R. Bioavailability and balance of Cu as affected by maize growing in a natural and a vineyard soil, <i>in preparation</i>.</p> <p>Cattani I.; Capri, E.; Boccelli, R.; del Re, A.A.M. Arsenic in polluted fields: mobility, bioavailability to plants and phytoextraction efficiency of <i>Pteris vittata</i>, <i>in preparation</i>.</p> <p>Fitz, W.J.; Wenzel, W.W.; Zhang, H.; Nurmi, J.; Stipek, K.; Fischerova, Z.; Schweiger, P.; Kollensperger, G.; Ma Lena, Q.; Stinger, G. 2003. Rhizosphere characteristics of the arsenic hyperaccumulator <i>Pteris vittata</i> L and monitoring of phytoremoval efficiency. Environ. Sci. Technol. 37: 5008-5014.</p> <p>Harper, M.P.; Davison, W.; Tych, W. 2000. DIFS – a modelling and simulation tool for DGT induced trace metal remobilisation in sediments and soils. Environ. Modell. Softw. 15: 55-66.</p> <p>Zhang, H.; Davison, W. 1995. Performance characteristics of diffusion gradients in thin films for the in situ measurement of trace metals in aqueous solution. Anal. Chem. 67: 3391-3400.</p>
Links	<p>a more detailed protocol for use of the apparatus is available upon request from the author</p>

ID	23_Dessureault_Rompre
Author	Dessureault-Rompré, Jacynthe ¹⁾ ; Tercier-Waeber, Mary-Lou ^{2)*} ; Koudelka-Hep, Milena ³⁾ ¹⁾ Institute of Terrestrial Ecosystems, ETH Zurich, Universitätstrasse 16, 8092 Zürich, Switzerland ²⁾ CABE, Dep. of Inorganic and Analytical Chemistry, Sciences II, University of Geneva; ³⁾ IMT, University of Neuchatel, Jaquet-Droz 1, 2007 Neuchatel, Switzerland * corresponding author: Marie-Louise.Tercier@cabe.unige.ch
Parameter	Speciation analysis of Cu, Pb, Cd and Zn in soil solutions
Soil type	Agricultural topsoil
Plant species	<i>Lupinus albus</i> , <i>Thlaspi caerulescens</i> , <i>Thlaspi perfoliatum</i>
System	Rhizobox
Method	Square wave anodic stripping voltammetric technique with gel integrated microelectrode arrays
Method description	<i>Rhizobox system and soil solution sampling: see 13_Dessureault_Rompre</i> <i>Voltammetric measurements:</i> Anodic stripping voltammetric techniques using Hg microelectrodes are among the most sensitive techniques for trace element analysis (Buffle and Tercier-Waeber, 2000). Moreover, they can be readily adapted to in-situ measurements. The method presented here has been developed by Tercier-Waeber <i>et al.</i> (2002) for aquatic systems. We tested and applied it to obtain heavy metal speciation information in rhizosphere soil solutions. This method is using a gel integrated microsensor which consists in an Agarose Membrane-covered Hg-plated Ir-based microelectrode array (μ -AMMIA) (Fig.1). Mercury semidrops are stable for days and can be regenerated electrochemically through the gel. Measurements are performed in two steps: equilibration of the gel with the test solution (typically a few min.) followed by voltammetric detection inside the gel. Direct measurements with this technique are largely selective to the so-called "dynamic" species, i.e. free ions and small labile complexes with size of a few nm, which are important for bioavailability and ecotoxicity interpretation. The concentrations of other metal species, i.e. colloidal and particulate M species, can be obtained after minimum sample pre-treatments (Tercier-Waeber <i>et al.</i> , 2002). From the current and potential of the voltammetric peaks of M in raw and pre-treated samples, both the overall concentration of dynamic species, $[M_{dyn}]$, and the corresponding degree of complexation, $[M_{dyn}] / [M_{tot}]$, can be determined. From these data, the distribution of M into its various dynamic species can also be determined by combining the measured value of $[M_{dyn}]$ with existing computer codes (Buffle and Tercier-Waeber, 2000).
Do's, don'ts, potential limitations, untested possibilities	<ul style="list-style-type: none"> • High sensitivity, i.e. 20 pM, and detection limit \geq 50 pM (using a voltammetric pre-concentration $t = 15$ min). • High reliability, i.e. standard deviation of a maximum of 10% over a week of continuous measurements. • Low iR drops (corresponds to the drop of the potential related to the resistance of the solution ($R =$ resistance of the solution) when the current is passing, produced by the redox reaction to the electrode) and reduced double layer capacitance allowing direct measurements in low ionic

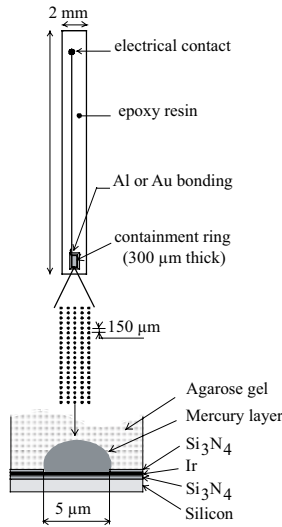
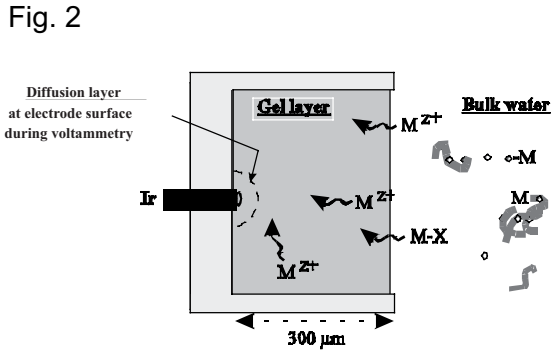
	<p>strength media (e.g. freshwaters, soil solutions).</p> <ul style="list-style-type: none"> • Effect of T on the signal readily corrected. • Multielement analysis, i.e. simultaneous analysis of Cu, Pb, Cd and Zn. • Speciation capabilities. • The agarose gel layer protects the electrode against ill-controlled hydrodynamic convection and avoids its fouling by colloids and macromolecules which are excluded from the gel. • Small analysis volume required. • Possible automatization and direct connection between the rhizobox-micro suction cup system and the voltammetric cell to achieve continuous on-line sampling of soil solutions and measurements of the dynamic heavy metal species in the rhizosphere of plants, however not tested yet.
References	<p>Buffle, J.; Tercier-Waeber, M.-L. 2000. In situ voltammetry: concepts and practice for trace analysis and speciation, In: Buffle, J.; Horvai, G. (eds.). In situ monitoring of aquatic systems; Chemical analysis and speciation. IUPAC Series in Analytical and Physical Chemistry of Environmental Systems. Wiley, Chichester, pp. 279-405.</p> <p>Tercier-Waeber, M.-L.; Buffle, J.; Koudelka-Hep, M.; Graziottin, F. 2002. Submersible voltammetric probes for in situ real-time trace element monitoring in natural aquatic systems. In: Taillefert, M.; Rozan, T.F. (eds.). Environmental Electrochemistry: Analysis of Trace Element Biogeochemistry. ACS Series No. 811, Washington DC, pp. 16-39.</p>
Links	<p>http://www.unige.ch/cabe/buffle/5.html</p>
Additional information	<p>Fig. 1</p>  <p>Fig. 2</p>  <p>Fig. 1. Schematic diagram of a μ-AMMIA.; Fig. 2. Principle of the gel-integrated microsensors; both figures adapted with permission from Tercier-Waeber et al. (2002); Copyright (2002) American Chemical Society.</p>

ID	23_Goettlein_a
Author	Göttlein, A. Fachgebiet Waldernährung u. Wasserhaushalt Wissenschaftszentrum Weißenstephan, Am Hochanger 13 D-85354 Freising Goettlein@forst.tu-muenchen.de; ++49 8161 71 4749
Parameter	pH, concentrations of major cations and anions in soil solutions
Soil type	Acid forest soils
Plant species	Oak, beech, spruce
System	Rhizotrons, root windows
Method	Capillary Electrophoresis (CE) and ISFET pH-sensor
Method description	<p><i>Anions by capillary electrophoresis</i> (Fig.1): Buffer: 3mM pyromellitic acid, adjusted to pH 8 using TEMED (N,N,N',N'-tetramethyl-ethylendiamine) Separation: -20 kV at 30 °C Detection: UV 230 nm</p> <p><i>Cations by capillary electrophoresis</i> (Fig.1): Buffer: 5 mM Metol (4-methylaminophenole-sulfate), 1 mM ascorbic acid, 2 mM 18-Crown-6 Separation: +15 kV at 20 °C Detection: UV 220 nm</p> <p><i>pH:</i> ISFET-sensor (Ion Sensitive Field Effect Transistor), supplied by Sentron (the Netherlands)</p>
Do's, don'ts, potential limitations, untested possibilities	<ul style="list-style-type: none"> • Buffers should be freshly prepared every day. The quality of Metol is very much changing from supplier to supplier and also between different lots of the same supplier. This is very critical for the determination of Al^{3+}. • Because CE sometimes produces outliers it is advisable to make double measurements for each sample to get reliable results. Over time there often is a marked drift in detection sensitivity which causes the need for a frequent recalibration of the system (Fig.2). • The accuracy of pH measurements by the ISFET sensor is enhanced when the ionic strength of the samples and the ionic strength of the calibration buffers are of comparable magnitude. When using commercially available calibration buffers they should be diluted.
References	<p><i>Description of the CE-methods, including information about quality of calibration and routine measurements:</i> Göttlein, A.; Blasek, R. 1996. Analysis of small volumes of soil solution by capillary electrophoresis. Soil Sci. 161: 705-715.</p> <p><i>More detailed information about the measurement of free Al^{3+} by CE:</i> Göttlein, A. 1998. Determination of free Al^{3+} in soil solution by capillary electrophoresis. Eur. J. Soil Sci. 49, 107-112.</p>

Additional information

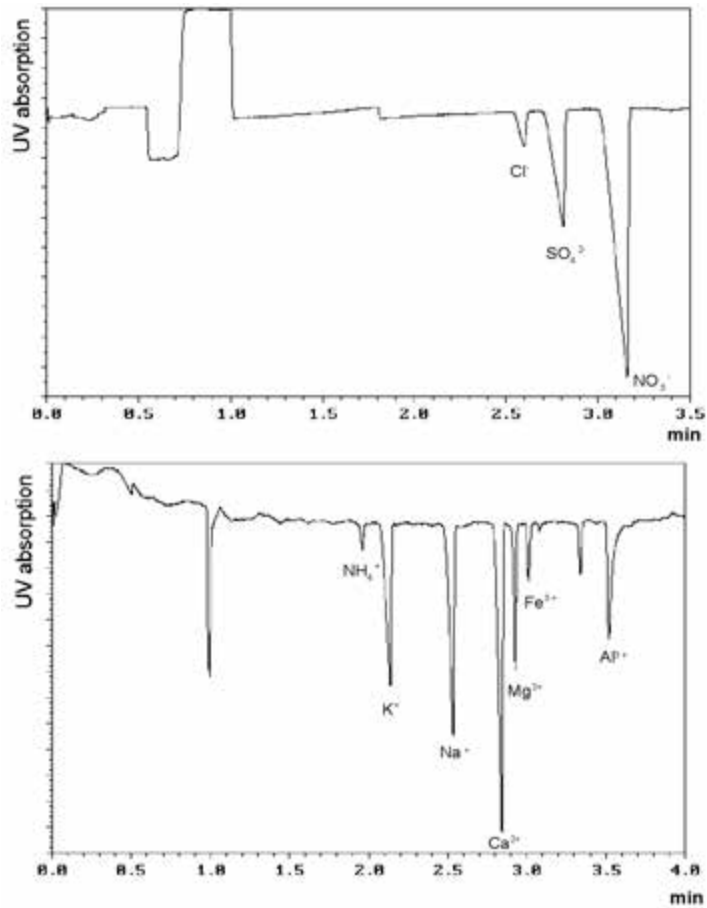

Fig.1: Anions and cations in a soil solution sample measured by CE

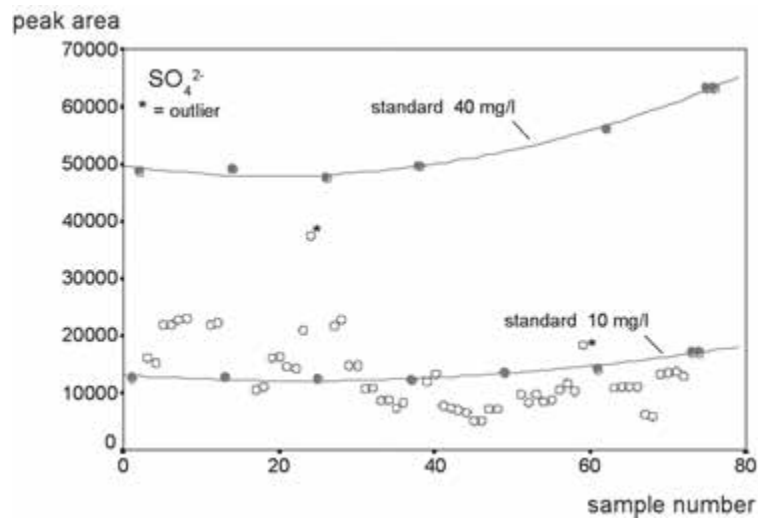
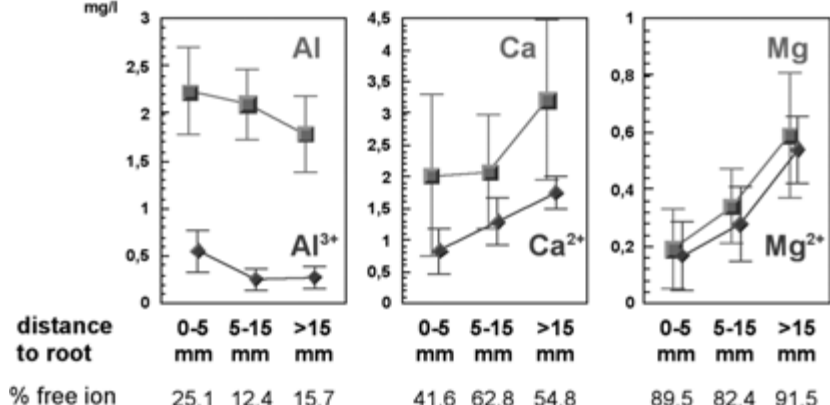

Fig.2: Drift of detector sensitivity and occurrence of outliers during an analytical run

ID	23_Goettlein_b
Author	Göttlein, A. Fachgebiet Waldernährung u. Wasserhaushalt, Wissenschaftszentrum Weißenstephan, Am Hochanger 13, D-85354 Freising Goettlein@forst.tu-muenchen.de; ++49 8161 71 4749
Parameter	Metal speciation in micro samples of soil solution
Soil type	Acid forest soils
Plant species	Oak
System	Rhizotrones, root windows
Method	Capillary Electrophoresis (CE) and ICP-OES with microinjection
Method description	<p><i>Free cations</i> are measured by capillary electrophoresis Buffer: 5 mM Metol (4-methylaminophenole-sulfate), 1 mM ascorbic acid, 2 mM 18-Crown-6 Separation: + 15 kV at 20 °C Detection: UV 220 nm</p> <p><i>Total concentrations</i> are measured by microinjection techniques at the inductively-coupled plasma optical emission spectrometer (ICP-OES), e.g. using a high pressure hydraulic nebulizer (Knauer, Berlin).</p>
Do's, don'ts	CE-buffer should be freshly prepared every day. The quality of Metol is very much changing from supplier to supplier and also between different lots of the same supplier. This is very critical for the determination of Al ³⁺ .
References	<p>Göttlein, A.; Heim, A.; Matzner, E. 1999. Mobilization of aluminium in the rhizosphere soil solution of growing tree roots in an acidic soil. <i>Plant Soil</i> 211: 41-49.</p> <p>Göttlein, A.; Matzner, E. 1997. Microscale heterogeneity of acidity related stress-parameters in the soil solution of a forested camic podzol. <i>Plant Soil</i> 192: 95-105.</p> <p>Heim, A. 1996. Der Einfluß wachsender Eichenwurzeln (<i>Quercus robur</i> L.) auf die Ionenzusammensetzung der wurzelnahen Bodenlösung. Diplomarbeit, Univ. Bayreuth.</p>
Additional information	 <p>Fig.1: Metal speciation by CE and microinjection-ICP of soil solutions sampled in different distances from an oak seedling (modified from Heim, 1996)</p>

ID	23_Graf-Pannatier
Author	Graf Pannatier, Elisabeth; Blaser, Peter; Pezzotta, Daniele; Luster, Jörg Swiss Federal Institute for Forest, Snow, and Landscape Research WSL, CH-8903 Birmensdorf, Switzerland elisabeth.pannatier@wsl.ch; ++41 44 739 23 30
Parameter	Inorganic Composition of Forest Soil Solutions (incl. sum parameters for organic C and N)
Soil type	Acid and calcareous forest soils
System	Field and Model Ecosystems
Method	Analysis of pH, electrical conductivity, inorganic anions, total element concentrations (nutrients, aluminum, trace metals), inorganic and organic carbon
Method description	<p><i>Soil solution sampling and sample preparation:</i> Soil solution is sampled by zero-tension or tension lysimetry (see 13_Graf-Pannatier). Immediately upon arrival of samples in the laboratory, the samples are filtered (0.45 µm membrane filter)</p> <p><i>Analyses of filtered samples:</i> Electrical conductivity; pH (combined glass electrode); non-purgeable organic carbon and total nitrogen (acidified samples, catalytic combustion with infrared and chemiluminescence detection; Shimadzu TOC-V); inorganic carbon (acid expulsion with infrared detection; Shimadzu TOC-V); NH₄ (flow injection analyses with colorimetric assay); inorganic anions (Cl⁻, SO₄²⁻, NO₃⁻, ion chromatography); total elemental concentrations (samples, acidified with HNO₃; inductively-coupled plasma-atomic emission spectrometry, ICP-AES: Ca, Mg, K, Na, Mn, Fe, Al, S; or ICP-mass spectrometry, ICP-MS: plus Cu, Zn, Cd, Pb).</p> <p><i>Storage</i> Aliquots before analysis and archive samples at 2°C.</p> <p><i>Quality assurance:</i> To get insight into the quality of the chemical analyses, blanks, certified reference materials and internal reference materials are routinely analysed. The ionic balance of each sample is calculated to validate the consistency of the results.</p> <p><i>Applications:</i></p> <ul style="list-style-type: none"> • Identification of seasonal short-term variations and long-term trends in element concentrations and ratios. • Assessment of the acidification status of a soil and the associated ecological risks using the BC/Al molar ratio ($BC = [Ca^{2+} + Mg^{2+} + K^+] / [Al_{tot}]$). BC/Al ratios smaller than 1 are considered to pose a potential risk to tree health. • Estimation of element fluxes through the soil based on water fluxes and element concentrations
Do's, don'ts, potential limitations, untested possibilities	<p><i>Representativity of measured values (samples collected with tension lysim.):</i></p> <ul style="list-style-type: none"> • pH: Degassing of CO₂ during sampling can increase the pH of the collected solution, especially in forest soils with pH values > 4.5 and pCO₂ in the soil > 0.01 atm. • trace metals: concentrations can be reduced by sorption to the suction cups (see 13_Graf-Pannatier)

	<p><i>Ionic Balance:</i> For soil solutions rich in DOC, a larger proportion of positive charges compared to negative charges can result. Measures to improve the ionic balance:</p> <ul style="list-style-type: none"> • calculate the charge on dissolved organic matter from DOC and pH (with equation of Oliver et al., 1983) and assume a lower charge for aluminium (< +3) • apply a chemical equilibrium model for waters accounting for complexation by humic substances (e.g. WHAM 6) • estimate alkalinity for solutions with pH > 5. <p><i>Chemical stability of soil solution after sampling (storage at 2° C):</i></p> <ul style="list-style-type: none"> • non-purgeable organic carbon: 2 weeks • conductivity, pH: 4 weeks (possibly longer) • total elemental concentrations (acidified), anions: 3 months (possibly longer) • TN, NH₄: 4 months (possibly longer) <p><i>Application to rhizosphere soil solution:</i> The considerations on storage, applications, representativity of data, ionic balance and chemical stability apply also to rhizosphere soil solutions collected with micro tension lysimeters (e.g. 13_Goettlein; chapter 1.3.). However, changes in solution composition due to interactions with the sampler may be different (13_Luster). For analyses microanalytical methods are necessary (23_Goettlein_a; 23_Nourisson)</p>
References	<p><i>Introduction to soil solution chemistry:</i> Wolt, J. D. 1994. Soil solution chemistry. Applications to Environmental Science and Agriculture. Wiley, New-York, 345 pp.</p> <p><i>Equilibrium model:</i> WHAM 6, 2001: Windermere Humic Aqueous Model, Equilibrium chemical speciation for natural waters, Version 6.0. @Natural Environment Research Council</p> <p>Oliver, B. G.; Thurman, E. M.; Malcom, R. L. 1983. Geochim. Cosmochim. Acta 47: 2031-2035</p> <p><i>Case studies on soil solution acidification:</i> Blaser, P.; Zysset, M.; Zimmermann, S.; Luster, J. 1999. Environ. Sci. Technol. 33: 2383-2389.</p> <p>Graf Pannatier, E. ; Walthert, L.; Blaser, P. 2004. J. Plant Nutr. Soil Sci., 167: 160-168</p> <p>Graf Pannatier, E.; Luster, J.; Zimmermann, S.; Blaser, P. 2005. Environ. Sci. Technol. 39: 7761-7767</p> <p><i>Time series studies:</i> Kvaalen, H. S.; Solberg, S.; Clarke, N.; Torp, T.; Aamlid, D. 2002. Environmental Pollution 117: 215-224</p> <p>Wesselink, L. G.; Meiwes, K. J.; Matzner, E.; Stein A. 1995. Environ. Sci. Technol. 29: 51-58.</p>
Links	<p>J. Derome et al. (Expert Panel on Soil), 2002. Submanual on Soil Solution Collection and Analysis, http://www.icp-forests.org/Manual.htm</p> <p>E. Graf Pannatier, 2003. Soil solution chemistry and soil water availability in LWF plots, http://www.wsl.ch/projects/soilsol/</p>

ID	23_Hinsinger_a
Author	Hinsinger, P.; Souche, G.; Jaillard, B. INRA-ENSA.M - UMR Rhizosphère & Symbiose Place Viala, F-34060 Montpellier cedex 1 (France) philippe.hinsinger@ensam.inra.fr ; ++33 4 99 61 22 49
Parameter	Proton efflux/influx from roots grown in hydroponics
Soil type	No soil – nutrient solution (might include solid suspension) only
Plant species	Any possible species
System	Growth chamber or glasshouse experiments in nutrient solution tanks
Method	pHstat – determination of proton fluxes at constant pH
Method description	This method is based on the continuous monitoring of the H ⁺ concentration with a pH electrode connected to dosing pumps that automatically deliver known volumes of solution when the actual H ⁺ concentration deviates from its initial fixed value (automatic titration). Such a pH-stat system requires one or, possibly, two dosing pumps for adding acid or base to the culture solution according to the direction of pH change. The system can be computer-controlled to maintain constant H ⁺ concentrations and monitor the acid or base additions over time. The net fluxes are then calculated from the successive additions of the solutions of acid or base.
Do's, don'ts, potential limitations, untested possibilities	The main advantage of the pH-stat system consists in the possibility to monitor over time the net fluxes of H ⁺ released by the whole root system and their kinetics as a function of any factor (such as the source of mineral N for instance) without any significant changes in pH, which could in turn modify the uptake rate of other ions. However, the method does not make it possible to evidence heterogeneities in root functioning, although these are well known to occur.
References	Glass, A.D.M.; Saccomani, M.; Crookall, G.; Siddiqi, V. 1987. A microcomputer-controlled system for the automatic measurement and maintenance of ion activities in nutrient solutions during their absorption by intact plants in hydroponic facilities. <i>Plant Cell Environ.</i> 10: 375-381. Blom-Zandstra, M.; Jupijn, V. 1987. A computer-controlled multi-titration system to study transpiration, OH ⁻ efflux and nitrate uptake by intact lettuce plants (<i>Lactuca sativa</i> L.) under different environmental conditions. <i>Plant Cell Environ.</i> 10: 545-550. Wollenweber, B. 1997 A sensitive computer-controlled pH-stat system allows the study of net H ⁺ fluxes related to nitrogen uptake of intact plants in situ. <i>Plant Cell Environ.</i> 20: 400-408. Tang, C.; Drevon, J.J.; Jaillard, B.; Souche, G.; Hinsinger, P. 2004. Proton release of two genotypes of bean (<i>Phaseolus vulgaris</i> L.) as affected by N nutrition and P deficiency. <i>Plant Soil</i> 260: 59-68.

Additional information (see also colour plate on p. 524)

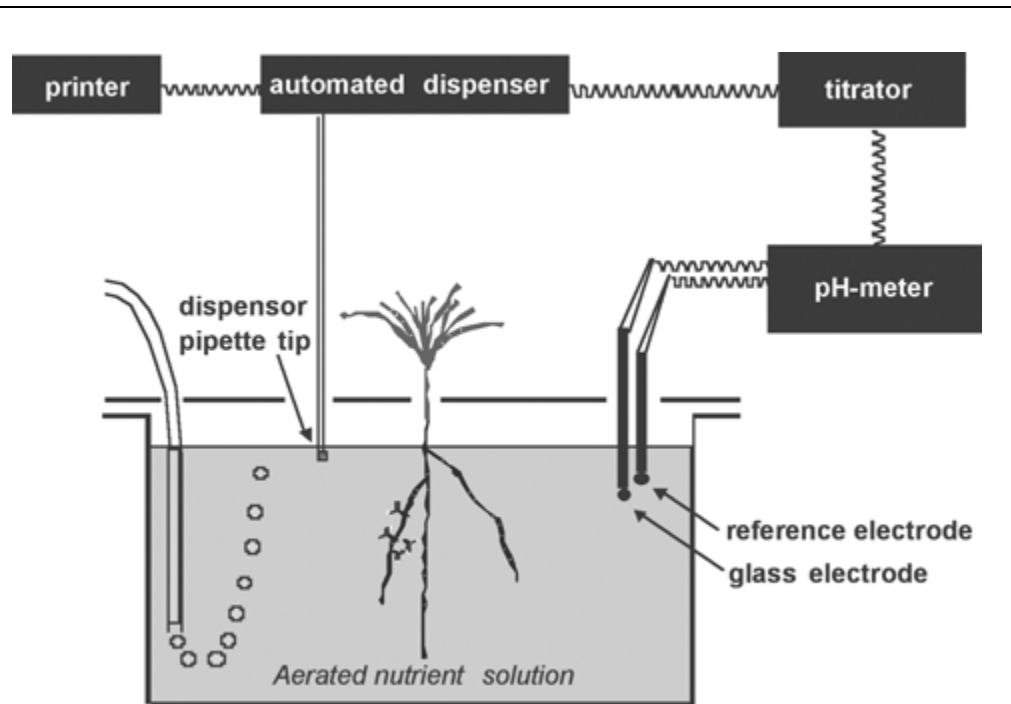
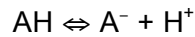

Fig. 1. Experimental set-up for continuous monitoring of proton efflux/influx from roots grown in hydroponics at a given pH values (pH-stat device).

ID	23_Hinsinger_b
Author	Hinsinger, P.; Souche, G.; Jaillard, B. INRA-ENSA.M - UMR Rhizosphère & Symbiose Place Viala, F-34060 Montpellier cedex 1 (France) philippe.hinsinger@ensam.inra.fr ; ++33 4 99 61 22 49
Parameter	Proton efflux / influx from roots grown in agarose gels
Soil type	No soil – transparent medium required (agarose gel)
Plant species	Any possible species, split root system possible for larger plants
System	lab microcosm
Method	Videodensitometry of dye-indicator/agarose gel
Method description	This is based on the use of agar gel-pH dye as a growth medium and image analysis for quantifying pH changes and associated proton fluxes along roots: three nonphytotoxic dyes can be used to cover the relevant pH range: bromocresol green, bromocresol purple and phenol red, with respective pKs of 4.7, 6.4 and 7.8. At a given wavelength specific to each of these, there is a univocal relationship between optical density and pH which enables to convert the grey image into a pH map. The technique being non invasive, repeated measurements over several tens of minutes provide access to the computation of proton fluxes at any location (simultaneous measurement).
Do's, don'ts, potential limitations, untested possibilities	<ul style="list-style-type: none"> • The main advantages are its simplicity, and its ability to get at once the response of the whole root system of a plant, compared with the use of microelectrodes. • A major limitation is the need for a transparent medium for valuable quantification. • The risk of a contribution of rhizosphere respiration to the observed pH decrease (due to a build-up of pCO₂) increases with the thickness of the agar. • The quality of the agar used will have an impact on the buffering capacity (and hence on the computation of proton fluxes), which is minimal with agarose. • The possibility to use reflected light might be applied to non transparent substrates (e.g. a gel containing a solid suspension) needs being tested, as well as simplified procedures of analysis.
References	<p>Calba, H.; Jaillard, B. 1997 Effect of aluminium on ion uptake and H⁺ release by maize. <i>New Phytol</i> 137: 607-616.</p> <p>Jaillard, B.; Ruiz, L.; Arvieu, J.C. 1996. pH mapping in transparent gel using color indicator videodensitometry. <i>Plant Soil</i> 183: 1-11.</p> <p>Plassard, C.; Meslem, M.; Souche, G.; Jaillard, B. 1999. Localization and quantification of net fluxes of H⁺ along maize roots by combined use of pH-indicator dye videodensitometry and H⁺-selective microelectrodes. <i>Plant Soil</i> 211: 29-39.</p> <p>Ruiz, L.; Arvieu, J.C. 1990. Measurement of pH gradients in the rhizosphere. <i>Symbiosis</i> 9: 71-75.</p>
Additional information	The agar-indicator method has been generally used as a qualitative method. Very few workers have tried to quantify this color-based information. It is nonetheless a classical colorimetric method which can be easily used for quantitative purposes by using a spectrodensitometer. The used pH indicators are sulphonephthaleins acting as weak acids in water. The colour change

results from a shift in the equilibrium between only two forms, phenolic and quinonic. Thus :



with: $K = [A^-] [H^+] / [AH]$

or: $K = (1-x) / x [H^+]$

where K is the dissociation constant of the indicator, and x is the molar fraction of the indicator in acidic form, i.e. $x = [AH] / ([A^-] + [AH])$. The optical density of the solution (D) is determined by the proportion of each form present at any given wavelength for a given concentration of indicator, as shown by the relation:

$$D = x D_A + (1-x) D_B$$

where D_A and D_B are, respectively, the optical densities of the acidic and alkaline solution. By combining equations (6) and (7), we can write:

$$[H^+] = K (D - D_B) / (D_A - D)$$

then: $pH = pK + \log (D - D_A) / (D_B - D)$

This relation leads therefore to using acidic and alkaline standard agar sheets as calibrating references for D_A and D_B . It is important that the thickness of the agar sheets is constant on the whole analysed area (for applying Beer-Lambert's law). To facilitate the measurement, pH of the agar sheet can be mapped directly using a scanning video camera connected to a computer for calculation and image analysis. The pH images can then be converted into images of total H^+ concentration in the medium, knowing its H^+ buffering capacity according to equation (1). The H^+ fluxes released by roots are then calculated as the differences in total H^+ concentrations at different time intervals. At each time intervals, a set of 15 to 25 images are obtained within a short period (few seconds) and summed up in order to minimize the measurement error.

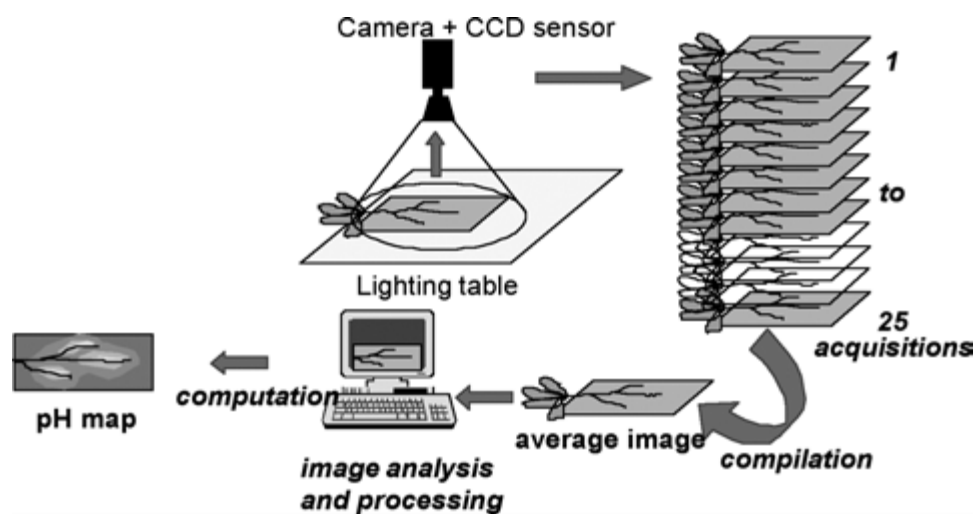

(see also colour plate on p. 524)

ID	23_Holm
Author	Holm, Peter E. Department of Natural Sciences, The Royal Veterinary and Agricultural University (KVL), Copenhagen, Thorvaldsensvej 40, DK-1871 Frederiksberg C, Denmark peho@kvl.dk; ++45 3528 2414
Parameter	Simultaneous determination of free Cd and Zn divalent ions and the operationally defined complexed fractions (labile, slowly labile, and stable complexes) in soil solutions
Soil type	all soils with pH between 5 and 7
Plant species	all
System	Soil solution, rhizosphere soil solution
Method	Two-part batch-column-batch procedure using two cation exchange resins and analytical determination by graphite furnace atomic absorption spectrometry (GF-AAS)
Method description	<p><i>Preparation:</i> The resins are transformed into Ca-forms and weighed into 50 mL bottles or 5 mL columns. The added amount of Amberlite resin varies (50-400 mg) according to the Ca and Mg concentration in solution.</p> <p><i>First part: Determination of Cd²⁺ and Zn²⁺:</i> The first batch experiment is performed identically for both the sample and reference solutions. This part is experimentally sensitive to cation concentrations and ionic strength and these parameters should be controlled during the experimental procedures (See Fig. 1 scheme in Holm et al. 1995): (i) 5-mL aliquot of solution is acidified for the determinations of the initial total metal concentrations in the solutions (M_T and M_T^* in Fig. 1, Holm et al., 1995); (ii) a 25-mL aliquot of solution is added to the bottle with resin (Amberlite) and shaken for 24 h during which pH is measured and controlled; (iii) solution and resin are separated and a minimum of 5 mL of solution sampled for total metal analysis (M_s and M_s^*).</p> <p><i>Second part: Determination of complexed fractions (labile, slowly labile, and stable complexes):</i> The column and second batch experiment: (i) in total, 20-mL of sample solution is added to the top of the resin column (2 g Chelex 100) at a rate of 2 mL min⁻¹. The effluent is sampled for analysis (M_{stst}); (ii) the final batch (100 mg Chelex resin) experiment involves 10 mL of sample equilibrated for 48 h before sampling (M_{st}).</p> <p><i>Analysis and calculations:</i> All Cd and Zn in solutions are determined by GF-AAS after acidification with HNO₃. The Cd and Zn speciation can then be calculated as described in Holm et al. (1995).</p>
Do's, don'ts, potential limitations, untested possibilities	<ul style="list-style-type: none"> • The method has only been documented for Cd and Zn in Holm et al. (1995) but can be for other cations. • For pH above 7 the fraction of hydroxyl complexes in solution must be taken into account as they will also develop in the reference experiment.

References	<p><i>Speciation of Cadmium and Zinc with Application to Soil Solutions.</i> Holm; P.E.; Christensen, T.H.; Tjell, J.C.; McGrath, S.P. 1995. Journal of Environmental Quality 24: 183-190.</p> <p><i>Changes in trace-metal species and other components of the rhizosphere during growth of radish:</i> Hamon, R.E.; Lorenz, S.E.; Holm, P.E.; Christensen, T.H.; McGrath, S.P. 1995. Plant Cell and Environment 18: 749-756.</p> <p><i>Cadmium and zinc in plants and soil solutions from contaminated soils.</i> Lorenz, S.E.; Hamon, R.E.; Holm, P.E.; Domingues, H.C.; Sequeira, E.M.; Christensen, T.H.; McGrath, S.P. 1997. Plant and Soil 189: 21-31.</p> <p><i>Adaptation of the ion exchange method for the determination of the free ionic fraction of cadmium in solution.</i> Schneider, A. 2006. Journal of Environmental Quality 35: 394-401.</p>
------------	--

ID	23_Jones_a
Author	Jones, Davey School of Agricultural and Forest Sciences, University of Wales, Bangor, Gwynedd, LL57 2UW, UK d.jones@bangor.ac.uk; ++44 1248 382579
Parameter	Dissolved inorganic and organic phosphorus in soil solution
Soil type	Any soil
Plant species	Any vegetation
System	All systems
Method	Colorimetric determination
Method description	<p><i>Inorganic phosphorous</i> For the reagent mix together the following: 1. 75 ml of the H₂SO₄ reagent (140 mL of conc. H₂SO₄ L⁻¹) 2. 25 ml of the NH₄-Mo reagent (15 g of ammonium molybdate in 500 mL water) 3. 25 mL of ascorbic acid solution (5.4 g of ascorbic acid in 100 ml of water) 4. 12.5 ml of K-Sb-Tartrate reagent (0.34 g of potassium antimony tartrate in 500 mL of water)</p> <p>To a flask add 21 mL of sample; then add 4 mL of reagent; wait for 10 min; read the absorbance at 880 nm.</p> <p><i>Organic phosphorous (DOP)</i> Here the DOP is oxidised to inorganic phosphate using a persulfate reagent. The phosphate in solution is then determined before and after oxidation in the normal colorimetric way (e.g. molybdate blue method). The difference between the two values is the DOP fraction.</p> <ol style="list-style-type: none"> Dissolve 10 g of potassium persulfate and 2.25 g of NaOH in 100 mL of distilled water in a clean acid-washed plastic bottle. Make up standards (0 to 50 µM KH₂PO₄ or glucose-1-phosphate) To a tube add the following: <ol style="list-style-type: none"> 5 mL of sample 1 mL of persulfate reagent Place in autoclave (121°C, 30 min) Let the samples cool Add 150 µL of 0.3 M HCl and mix Measure inorganic P before and after oxidation
Do's, don'ts, potential limitations, untested possibilities	<ul style="list-style-type: none"> An easy method to use. The glucose-1 phosphate should all be converted to PO₄³⁻ during the oxidation procedure (internal check of method) and the PO₄³⁻ should give 100% recovery after taking into account the dilution factor. Any organic P standard can be used.
References	Williams, B.L.; Shand, C.A.; Hill, M.; Ohara, C.; Smith, S.; Young, M.E. 1995. A procedure for the simultaneous oxidation of total soluble nitrogen and phosphorus in extracts of fresh and fumigated soils and litters. <i>Comm. Soil Sci. Plant Anal.</i> 26: 91-106.

ID	23_Jones_b
Author	Jones, Davey School of Agricultural and Forest Sciences, University of Wales, Bangor, Gwynedd, LL57 2UW, UK d.jones@bangor.ac.uk; ++44 1248 382579
Parameter	Dissolved organic nitrogen in soil solution
Soil type	Any soil
Plant species	Any vegetation
System	All systems
Method	Colorimetric determination
Method description	<p>Here the DON is oxidised to nitrate using persulfate reagent. The nitrate in solution is then determined before and after oxidation in the normal colorimetric way. The difference between the two values is the DON fraction.</p> <p><i>Oxidation Procedure</i></p> <ol style="list-style-type: none"> 1. Dissolve 2.02 g of potassium persulfate and 0.45 g of NaOH in 50 mL of distilled water in a clean acid-washed plastic bottle. 2. Make up a set of standards (0 to 10 mg N L⁻¹ of both KNO₃ and urea) 3. To a tube add the following: <ol style="list-style-type: none"> i. 1.5 mL of extract or soil solution ii. 0.5 mL of persulfate reagent 4. Stopper the tubes and place them in an autoclave (121°C, 30 min). 5. Let the tubes cool and then measure the NO₃⁻ content. <p>Nitrate can be measured using colorimetry or ion chromatography. Personally we use a Skalar Ltd autoanalyser with this method.</p>
Do's, don'ts, potential limitations, untested possibilities	<ul style="list-style-type: none"> • An easy method to use. • The urea should all be converted to NO₃⁻ during the oxidation procedure (internal check of method) and the NO₃⁻ should give 100% recovery after taking into account the dilution factor.
References	Williams, B.L.; Shand, C.A.; Hill, M.; Ohara, C.; Smith, S.; Young, M.E. 1995. A procedure for the simultaneous oxidation of total soluble nitrogen and phosphorus in extracts of fresh and fumigated soils and litters. <i>Comm. Soil Sci. Plant Anal.</i> 26: 91-106.

ID	23_Kruyts
Author	Kruyts, Nathalie ¹ ; Stephan, Chadi H. ² ; Courchesne, François ³ ; Sauvé, Sébastien ² ¹) Département des sciences du milieu et de l'aménagement du territoire, Université catholique de Louvain, 1348 Louvain-la-Neuve, Belgique. kruyts@sols.ucl.ac.be ²) Department of Chemistry, Université de Montréal, P.O. 6128 Centre-Ville, Montréal, QC, Canada, H3C 3J7. ³) Department of Geography, Université de Montréal, P.O. 6128 Centre-Ville, Montréal, QC, Canada, H3C 3J7.
Parameter	Metal (e.g. Zn) labile fractions in soil solutions
Soil type	acid forest soil
System	field soil, rhizosphere and bulk
Method	Differential pulse anodic stripping voltammetry (DPASV)
Method description	Differential pulse anodic stripping voltammetry (DPASV) is a very sensitive electrochemical method to determine the concentration of "labile" metals such as lead, copper and cadmium in contaminated soils. We recently use it to measure the "labile" zinc in rhizosphere and bulk soil solutions. Soil solutions were extracted by ultra-pure water (soil : solution ratio 1:10). The soil suspension was shaken (2 h), centrifuged (1400 g for 15 min), and filtered using cellulose filters (Osmonic micronSep mixed esters 0.45 µm) on a vacuum system. The labile Zn in the filtrates was quantified by DPASV analysis, using a TraceLab [®] 50 polarograph from Radiometer Analytical (Lyon, France) with a hanging mercury drop electrode module (MDE 150). The samples were pre-purged for 5 min with N ₂ to remove dissolved oxygen. A 1.2 V potential was used for the electrodeposition step of 60 s, with stirring followed by a 15 s homogenization period, without stirring. Metal stripping was then carried out using electrical currents ranging from 0.1 µA to 1 mA, as necessary.
Do's, don'ts, potential limitations, untested possibilities	<ul style="list-style-type: none"> • DPASV can be used for many metals • The "labile" fraction of metals in soil solution is highly pH-dependant. Thus, control of pH across the experiment is needed. • DPASV is able to measure the amount of metal that is kinetically available for electrodeposition onto the Hg drop. This fraction, called labile, is assumed to include metal dissociated from inorganic ion-pairs (such as hydroxyl, carbonate, nitrate and sulfate). According to parameters used for DPASV procedure, some metal-organic complexes could be electrochemically labile, and if so, the labile inorganic metal pool would be correspondingly overestimated.
References	Sauvé, S.; Norvell, W.A.; McBride, M.; Hendershot, W. 2000. Speciation and Complexation of Cadmium in Extracted Soil Solutions. <i>Environmental Science & Technology</i> 34 : 291-296. Courchesne, F.; Kruyts, N.; Legrand, P. 2006. Labile zinc concentration and free copper ion activity in the rhizosphere of forest soils. <i>Environ. Tox. Chem.</i> 25: 635-642.

ID	23_Loes
Author	Løes, Anne-Kristin Bioforsk Organic Food and Farming Division, N-6630 Tingvoll, Norway anne-kristin.loes@bioforsk.no; ++47 71 53 20 26
Parameter	Rhizosphere pH
Soil type	Agar with nutrient solution
Plant species	Wheat and barley
System	Petri dish
Method	Visualisation of changes in rhizosphere pH in dye-indicator/agarose gel
Method description	Petri dishes were filled with a mixture of nutrient solution, agar and pH-sensitive dye (Bromocresol purple), and cereal seedlings were put in just before the agar stiffened. Plants were kept in a greenhouse, agar covered with aluminium foil. Colour changes were recorded with a flatbed scanner.
Do's, don'ts, potential limitations, untested possibilities	<ul style="list-style-type: none"> • Wash the kettles to melt the agar carefully with acid to remove possible calcium precipitations. • Avoid using a pH meter after agar has been added, as this may cause malfunctioning of the ceramic sensor. • Useful to have a series of standard solution aliquots with dye for visual assessment of the pH. The volume and form of the container influences the intensity of the colour. • Stiff agar can be melted and used later. • Plants tolerate embedding in agar at 40 °C. Agar starts hardening at 37 °C. Plants survived for up to 5 days, but gradually the agar will get infected by mould, and crack because of desiccation. • In control dishes without plants kept in the greenhouse, the pH decreased in some dishes, and increased in other. In control dishes kept in the refrigerator (5 °C), the pH did not change. • The method is well suited to study changes in rhizosphere pH with time. It may also be used to study possible rhythms of pH changes, possibly linked to uptake / exudation of ions, according to light intensity and duration of light (dark) period. Comparing varieties may be complicated by such rhythms, or individual growth patterns in each plant. In some varieties, the replicates behaved quite differently with respect to decreasing or increasing the pH of the agar. • The method is excellent to demonstrate rhizosphere processes e.g. for students.
References	<i>How to prepare the agar solution:</i> Engels, C.; Neumann, G.; Gahoonia, T.S.; George, E.; Schenk, M. 2000. In situ measurements in the rhizosphere. In: Smit, A.L., Bengough, A.G., Engels, C., van Noordwijk, M., Pellerin, S. and van de Geijn, S.C. (eds.). Root methods, a handbook. Springer, pp. 417-419.

Additional information (see also colour plates on p. 525)

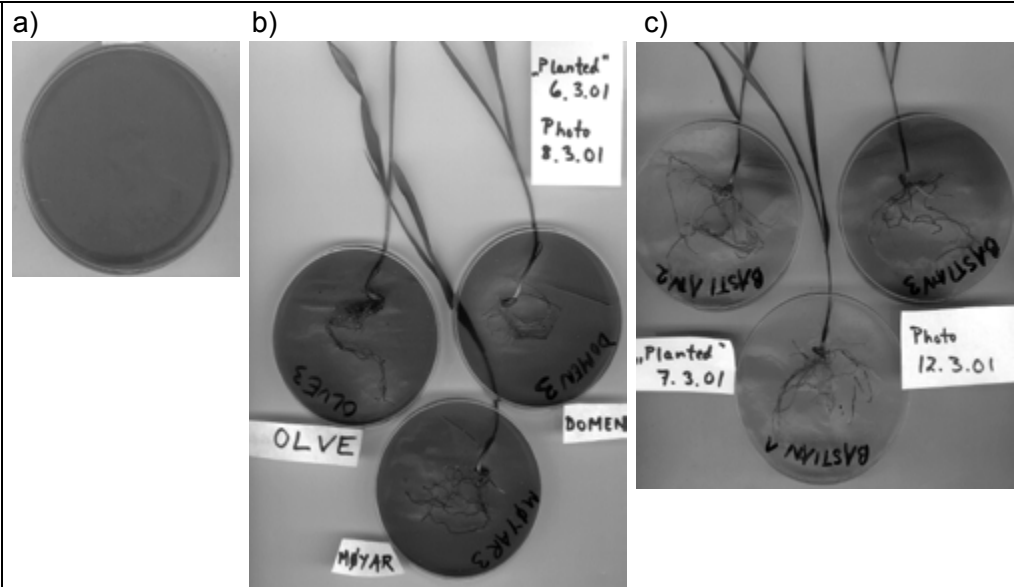

Fig. 1: At pH 7, the agar is greyish-pink (a). In total, 35 varieties of barley and 17 of wheat were compared. The N-source was nitrate, and hence a pH increase was to be expected. In general, pH increased in barley (blue agar; b), but decreased in wheat (yellow agar, c).

ID	23_Luster
Author	Luster, Jörg ¹⁾ ; Graf-Pannatier, Elisabeth ¹⁾ ; Heim, Alexander ²⁾ ; Pezzotta, Daniele ¹⁾ ¹⁾ Swiss Federal Research Institute WSL, CH-8903 Birmensdorf, Switzerland; joerg.luster@wsl.ch; ++41 44 739 22 95 ²⁾ University of Zürich, Department of Geography, Physical Geography, Winterthurerstr. 190, CH-8057 Zürich, Switzerland
Parameter	Aluminum Speciation in Forest Soil Solutions
Soil type	Acid forest soils
System	Field
Method	Total Al by ICP / OES Monomeric Al by Eriochrome cyanine R method Complexation labile Al by 8-hydroxyquinoline method Al measured by capillary electrophoresis
Method description	<i>Soil solution sampling and sample preparation: see 13_Graf-Pannatier</i> <i>Total Aluminum</i> We use inductively-coupled plasma optical emission spectrometry (ICP / OES). However, any other method to measure total element concentrations in aqueous solutions can be used. <i>Mononuclear Aluminum</i> is measured by using a flow injection analysis (FIA) method. The sample is injected into a carrier solution of 0.01 M NaCl, pH4, and allowed to react with the coloured ligand Eriochrome cyanine R for 30 s. The reaction is buffered at pH 7.5. Finally, the colour of the formed complexes is measured photometrically. <i>Complexation-labile Aluminum</i> is measured by using a FIA method. The sample is injected into a carrier solution of 0.01 M NaCl, pH4, and allowed to react with 8-hydroxyquinoline (HQ) for 2.3 s. The reaction is buffered at pH 5.0. The reaction is stopped by extracting the Al complexes with HQ into chloroform. Finally the colour of the complexes in chloroform is measured photometrically. <i>Capillary Electrophoresis (CE)</i> The free aquoion Al ³⁺ is measured with a CE method for cations using a coloured Metol buffer and negative photometric detection.
Do's, don'ts, potential limitations, untested possibilities	<i>Methodological Aspects</i> <ul style="list-style-type: none"> FIA methods: Fe needs to be masked with 1,10-phenanthroline. CE: with the Metol method, the following cations are measured as well: NH₄⁺, Na⁺, Mg²⁺, K⁺, Ca²⁺, (Mn²⁺ + Fe³⁺); Calibration curves for Al³⁺ are often not linear. In addition, sensitivity for Al³⁺ can decrease rapidly during analysis which requires frequent control measurements of standards and suitable measures to correct standard curves. At high concentrations, an additional signal for the 1:1 complex of Al with oxalate is observed. <i>Chemical significance of the measured fractions</i> Except for total Al, all fractions are operationally defined. Based on results of experiments with model ligands in synthetic soil solutions, the following

	<p>interpretations can be made:</p> <ul style="list-style-type: none"> • Capillary electrophoresis measures mainly free Al^{3+}, but some labile Al complexes with phenolic ligands can dissociate during the separation and are assessed as well. • Complexation labile Al includes free Al^{3+}, the mononuclear hydrolytic Al species and Al in labile complexes with low-molecular weight phenolic ligands. • Mononuclear Al, in addition, includes all complexes with low-molecular weight aliphatic ligands (e.g. oxalate, citrate). • The difference between total and mononuclear Al is called polynuclear Al. This fraction includes polynuclear hydroxo complexes as well as some complexes with high-molecular weight dissolved organic matter.
References	<p><i>On the interpretation of complexation labile Al:</i> Luster, J.; Yang, A.; Sposito, G. 1993. On the Interpretation of Labile Aluminum as Determined by Reaction with 8-Hydroxyquinoline. Soil Sci. Soc. Am. J. 57: 976-980.</p> <p><i>Description of the method for monomeric Al:</i> Royset, O. 1992. Flow injection analysis for the determination of aluminium in water from forest soils; paper VII. Ph.D. thesis, Norwegian Forest Research Institute.</p> <p><i>Description of the method for complexation labile Al:</i> Clarke, N.; Danielsson, L.G.; Sparen, A. 1992. The determination of quickly reacting aluminium in natural waters by kinetic discrimination in a flow system. Intern. J. Environ. Anal. Chem. 48: 77-100.</p> <p><i>Description of the capillary electrophoresis method</i> Heim, A.; Luster, J.; Brunner, I.; Frey, B.; Frossard, E. 1999. Effects of aluminium treatment on Norway spruce roots: Aluminium binding forms, element distribution, and release of organic substances. Plant Soil 216: 103-116.</p> <p>Göttlein, A. 1998. Determination of free Al^{3+} in soil solution by capillary electrophoresis. Europ. J. Soil Sci. 49, 107-112.</p> <p><i>Comparison of the different speciation methods with synthetic soil solutions, and application to soil solutions collected with tension lysimeters in the field</i> Luster, J.; Pena-Rodriguez, M.; Heim, A.; Blaser, P. 1999. Aluminum speciation in acid forest soil solutions: comparison of different methods. Proc. 5th Intern. Conf. on the Biogeochemistry of Trace Elements, Vienna: 666-667.</p>

ID	23_Nourrisson																								
Author	Nourrisson, G.; Turpault, M.-P.* INRA-BEF 54280 Champenoux, France. *corresponding author: turpault@nancy.inra.fr; ++33 3 83 39 40 75																								
Parameter	Total element (Al, Si, Ca, Fe, K, Mg, Mn, TOC) and ion (NH₄⁺, NO₃⁻, Cl⁻, F⁻, SO₄²⁻, PO₄²⁻) concentrations, pH in soil solution																								
Soil type	acid forest soil																								
Plant species	All forested species																								
System	Soil solutions obtained by micro-suction cups in field soil or in microcosm																								
Method	A chain of analyses adapted to volumes of < 2ml																								
Method description	<p>The volumes of rhizosphere soil solutions collected are often very small, so in this note we suggest an alternative chain of analysis, for use when capillary electrophoresis is not available. It consists of a selection of analytical methods and adaptations to analytical apparatus to carry out chemical analyses of samples of limited volume (< 2ml). The choices are summarised in Table 1.</p> <table border="1" data-bbox="389 920 1374 1541"> <thead> <tr> <th>Analyte</th> <th>Method</th> <th>Apparatus</th> <th>Sample volume [μL]</th> </tr> </thead> <tbody> <tr> <td>Al, Ca, Fe, K, Mg, Mn, Si</td> <td>inductively coupled plasma optical emission spectrometry (ICP/OES)</td> <td>JOBIN-YVON JY 180 ULTRACE</td> <td>350-400</td> </tr> <tr> <td>NO₃⁻, NH₄⁺</td> <td>colorimetry using an autoanalyzer</td> <td>BRAN & LUEBBE TRAACS 2000</td> <td>300 (manual) to 500 (automatic)</td> </tr> <tr> <td>Total organic carbon (TOC)</td> <td></td> <td>SHIMADZU TOC 5050</td> <td>300 to 500 (undiluted sample); 1500 (after dil.)</td> </tr> <tr> <td>Cl⁻, F⁻, SO₄²⁻, PO₄³⁻</td> <td>ion chromatography</td> <td>DIONEX DX 320</td> <td>250; 40 to 60 (optimised)</td> </tr> <tr> <td>pH</td> <td>pH electrode</td> <td>SENTRON ARGUS; Electrode CUPFET HOT LINE</td> <td>40</td> </tr> </tbody> </table>	Analyte	Method	Apparatus	Sample volume [μ L]	Al, Ca, Fe, K, Mg, Mn, Si	inductively coupled plasma optical emission spectrometry (ICP/OES)	JOBIN-YVON JY 180 ULTRACE	350-400	NO ₃ ⁻ , NH ₄ ⁺	colorimetry using an autoanalyzer	BRAN & LUEBBE TRAACS 2000	300 (manual) to 500 (automatic)	Total organic carbon (TOC)		SHIMADZU TOC 5050	300 to 500 (undiluted sample); 1500 (after dil.)	Cl ⁻ , F ⁻ , SO ₄ ²⁻ , PO ₄ ³⁻	ion chromatography	DIONEX DX 320	250; 40 to 60 (optimised)	pH	pH electrode	SENTRON ARGUS; Electrode CUPFET HOT LINE	40
Analyte	Method	Apparatus	Sample volume [μ L]																						
Al, Ca, Fe, K, Mg, Mn, Si	inductively coupled plasma optical emission spectrometry (ICP/OES)	JOBIN-YVON JY 180 ULTRACE	350-400																						
NO ₃ ⁻ , NH ₄ ⁺	colorimetry using an autoanalyzer	BRAN & LUEBBE TRAACS 2000	300 (manual) to 500 (automatic)																						
Total organic carbon (TOC)		SHIMADZU TOC 5050	300 to 500 (undiluted sample); 1500 (after dil.)																						
Cl ⁻ , F ⁻ , SO ₄ ²⁻ , PO ₄ ³⁻	ion chromatography	DIONEX DX 320	250; 40 to 60 (optimised)																						
pH	pH electrode	SENTRON ARGUS; Electrode CUPFET HOT LINE	40																						
Do's, don'ts, potential limitations, untested possibilities	<p><i>To optimise the analyses, several rules should be followed:</i></p> <ul style="list-style-type: none"> • only use the sample solution for the analyses (do not rinse the analysis tubes with the sample). • avoid any transfers of the sample solution into different analysis tubes (suck the solution directly from the sampling tube, as this often avoids using an automatic sampler). • reduce the length of the sampling tube or capillary as much as possible for each apparatus without modifying the quality of the analysis. • only dilute the sample when there is no alternative way of avoiding manipulations. 																								

	<p><i>Specific optimisations:</i></p> <ul style="list-style-type: none"> • ICP / OES analysis: Tests carried out in the laboratory showed that the volume of sample needed for the acquisition of one total analysis was between 350 and 400 μL for a flow of $0.228 \text{ ml Min}^{-1}$. • <i>Automatic microflux colorimetric analysis : Using manual sample introduction, the volume can be optimised at 30 μL.</i> • TOC analysis : If the solutions are diluted by 3 to 5 times, the used volume is 300 and 500 μL, respectively. • Ion chromatography: The volume can be optimised at 40-60 μL. • pH : Only 40 μl is necessary.
References	<p><i>Collection of basic method descriptions:</i> Sparks, D.L. (ed.). 1996. Methods of Soil Analysis; Part 3, Chemical Methods. Soil Science Society of America Book Series No. 5, Soil Science Society of America, Madison WI, 1390 pp.</p>
Links	<p>a more detailed protocol for use of the apparatus is available upon request from the author</p>

ID	23_Plassard
Author	Plassard, C. INRA-ENSA.M - UMR Rhizosphère & Symbiose Place Viala, F-34060 Montpellier cedex 1 (France) plassard@ensam.inra.fr ; ++33 4 99 61 24 73
Parameter	Ion efflux / influx from roots grown in hydroponics
Soil type	No soil – nutrient solution only
Plant species	Any species of reasonable size
System	Growth chamber or glasshouse experiments in nutrient solution tanks
Method	Ion-selective microelectrodes
Method description	This method is based on the measurement of ion activities in the flowing solution surrounding the root using microelectrodes selective for H ⁺ , K ⁺ or NO ₃ ⁻ . Microelectrodes are “home-made” (see references). After calibration, the microelectrode tip is placed at the root surface of a plant bathed in a flowing solution in a perspex chamber using micromanipulators, inside a Faraday cage. Net ion fluxes (J, in μmol h ⁻¹ g ⁻¹ FW) are calculated according to the equation $(J) = 2\pi Dk(C_2 - C_1) / [A d \ln(r_2/r_1)]$ where D is the self-diffusion coefficient for the ion (9.17 x 10 ⁻⁵ , 1.69 x 10 ⁻⁵ and 1.92 x 10 ⁻⁵ cm ² s ⁻¹ for H ⁺ , K ⁺ and NO ₃ ⁻ , C ₁ and C ₂ are the activities of the ion concerned (mM) at radial distances r ₁ and r ₂ (cm) from the root axis, A is the cross-section area of the root (cm ²), d is the density of root tissue (g.cm ⁻³) and k is a conversion factor for units.
Do's, don'ts, potential limitations, untested possibilities	<i>Main advantage:</i> Possibility to monitor simultaneously several net ion fluxes as a function of any factor and to study the actual heterogeneity of root functioning. <i>Main limitations:</i> <ul style="list-style-type: none"> • depending on the magnitude of root activity • measurements of uptake cannot be carried out at high external concentrations • the availability of ion selective cocktails. For example P-selective cocktail is not available and P fluxes are not measurable with this method.
References	Newman, I.A.; Kochian, L.V.; Grusak, M.A.; Lucas, W.J. 1987. Fluxes of H ⁺ and K ⁺ in corn roots: characterization and stoichiometries using ion-selective microelectrodes. Plant Physiology 84: 1177-1184. Plassard, C.; Meslem, M.; Souche, G.; Jaillard, B. 1999. Localization and quantification of net fluxes of H ⁺ along maize roots by combined use of pH-indicator dye videodensitometry and H ⁺ -selective microelectrodes. Plant Soil 211: 29-39. Plassard, C.; Guérin-Laguette, A.; Véry, A.-A.; Casarin, V.; Thibaud, J.-B. 2002. Local measurements of nitrate and potassium fluxes along roots of maritime pine. Effects of ectomycorrhizal symbiosis. Plant Cell Environment 25: 75-84.

Additional information (see also colour plate on p. 525)

Fig. 1. Experimental set-up for continuous monitoring of ion fluxes using ion-selective microelectrodes.
1: Intact plant in a perspex cuvette, 2: flowing solution, 3: ion-selective microelectrodes plugged in headstages and moved by a hand-controlled motor, 4: amplifier, 5: interface (McLab), 6: computer (MacIntosh), 7: combined pH-macroelectrode, 8: mobile plate moving the cuvette using computer controlled motors, 9: Faraday cage

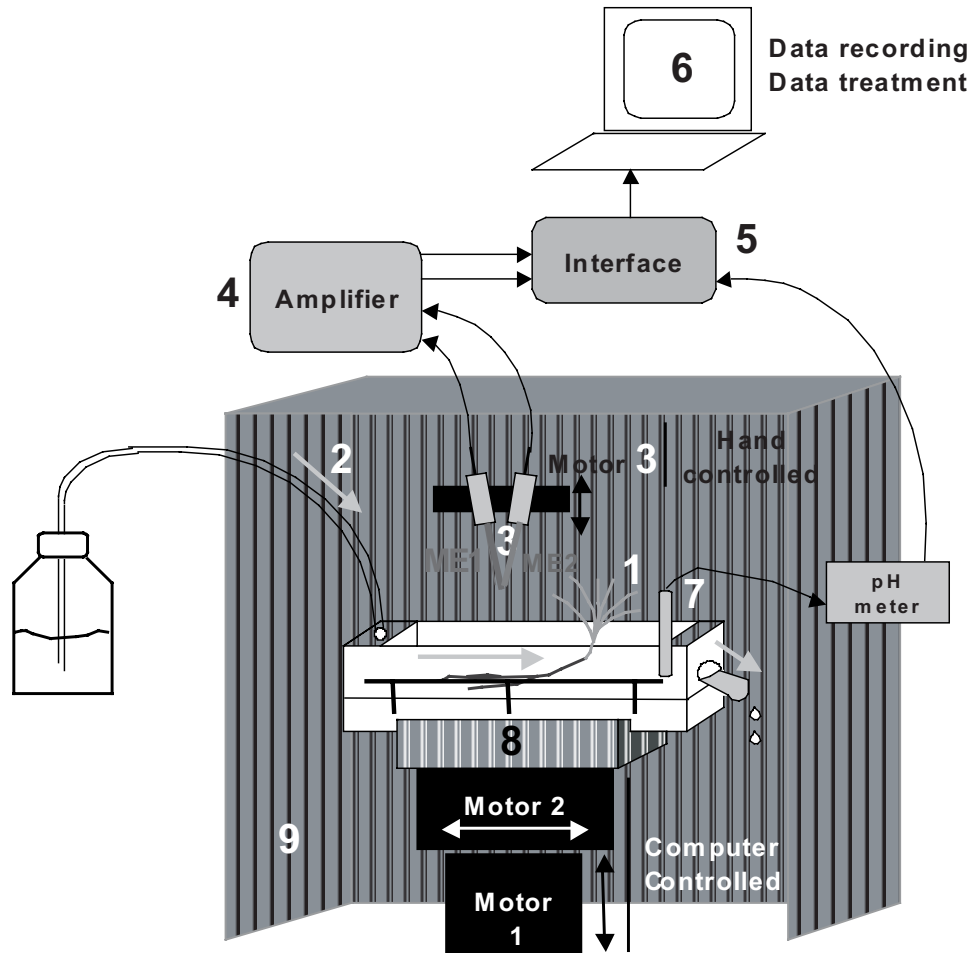

ID	23_Puschenreiter_a
Author	Puschenreiter, Markus Department of Forest and Soil Sciences, BOKU - University of Natural Resources and Applied Life Sciences, Vienna Peter Jordan Strasse 82, A-1190 Vienna, Austria markus.puschenreiter@boku.ac.at; ++43 1 47654 3126
Parameter	pH and redox potential in rhizosphere soil solution
Soil type	any
Plant species	any
System	Rhizobox
Method	Online measurement with pH and redox electrodes
Method description	Rhizoboxes (see 11_Fitz) equipped with pH and redox electrodes at defined distance from the rhizoplane (e.g. 1, 2, 3 mm) may be used for online determination of pH and redox potential in rhizosphere soil at mm-scale. A number of electrodes may be installed into each rhizobox. Preferably, both types of electrodes should be used together. Connection to computer facilities allows continuous measurements during the experiment.
Do's, don'ts, potential limitations, untested possibilities	<ul style="list-style-type: none"> • Before installing the electrodes into the rhizosphere soil compartment of the rhizobox, each electrode must be checked very carefully for its proper function. Calibration is necessary for the pH electrodes. The redox electrodes don't have to be calibrated separately, since their function is closely related to the performance of the pH electrodes. • Stable climatic conditions and soil water content are prerequisite to obtain comparable data during the whole experiment.
References	Wenzel, W.W.; Wieshammer, G.; Fitz, W.J.; Puschenreiter, M. 2001. Novel rhizobox design to assess rhizosphere characteristics at high spatial resolution. <i>Plant and Soil</i> 237: 37-45.
Links	www.rhizo.at
Additional information	<p>Fig. 1 . Rhizoboxes equipped with pH and redox electrodes connected to a computer for online measurement.</p> 

ID	23_Puschenreiter_b
Author	Puschenreiter, Markus Department of Forest and Soil Sciences, BOKU - University of Natural Resources and Applied Life Sciences, Vienna Gregor Mendel Straße 33, A-1180 Vienna, Austria markus.puschenreiter@boku.ac.at; ++43 1 47654 3121
Parameter	Trace elements and heavy metals in rhizosphere soil solution
Soil type	any
Plant species	any
System	Rhizobox
Method	Sampling with micro tension lysimeters; Analysis with ICP-MS or GF-AAS
Method description	<i>Sampling:</i> Rhizoboxes (see 11_Fitz) equipped with micro suction cups at defined distance from the rhizoplane (e.g. 1, 2, 3 mm) may be used for determination of trace elements and heavy metals in rhizosphere soil solution at mm-scale. A number of suction cups (Fig. 1.) may be installed into each rhizobox. Applying vacuum allows to collect approx. 10 – 20 µl of soil solution in small sample vials (e.g. 250 µl Eppendorf vials). The specific volume has to be determined using a balance (tara weight should be determined before!). The collection may be done in daily intervals, which allows detailed insight into time-dependent changes in rhizosphere soil solution chemistry. <i>Analysis:</i> Dilution of the sample to a volume of 100 µl is necessary before analysing by inductively-coupled plasma mass spectrometry (ICP-MS) or graphite furnace atomic absorption spectrometry (GF-AAS).
Do's, don'ts, potential limitations, untested possibilities	<ul style="list-style-type: none"> • Only carefully washed Eppendorf vials should be used to avoid any contamination of the sample. Preferably, the vials should be washed in propanol and subsequently in subboiled HNO₃ before use. Finally, the vials should be washed in subboiled (or any high grade clean) water. • Stable climatic conditions and soil water content are prerequisite to obtain comparable data during the whole experiment. • The method may be applied for any trace element or heavy metal, but also for minerals like P and N. Limitation is given by the detection limit of the analytic equipment and by the sample volume needed. ICP-MS offers the best options for determining very low concentrations.
References	Wenzel, W.W.; Wieshammer, G., Fitz, W.J.; Puschenreiter, M. 2001. Novel rhizobox design to asses rhizosphere characteristics at high spatial resolution. <i>Plant and Soil</i> 237: 37-45. Puschenreiter, M; Wenzel, W.W.; Wieshammer, G.; Fitz, W.J.; Wiczorek, S.; Kanitsar, K.; Köllensperger, G. 2005. Novel micro-suction-cup design for sampling soil solution at defined distances from roots. <i>J. Plant Nutr. Soil Sci.</i> 168: 386-391.
Links	www.rhizo.at

Additional Information

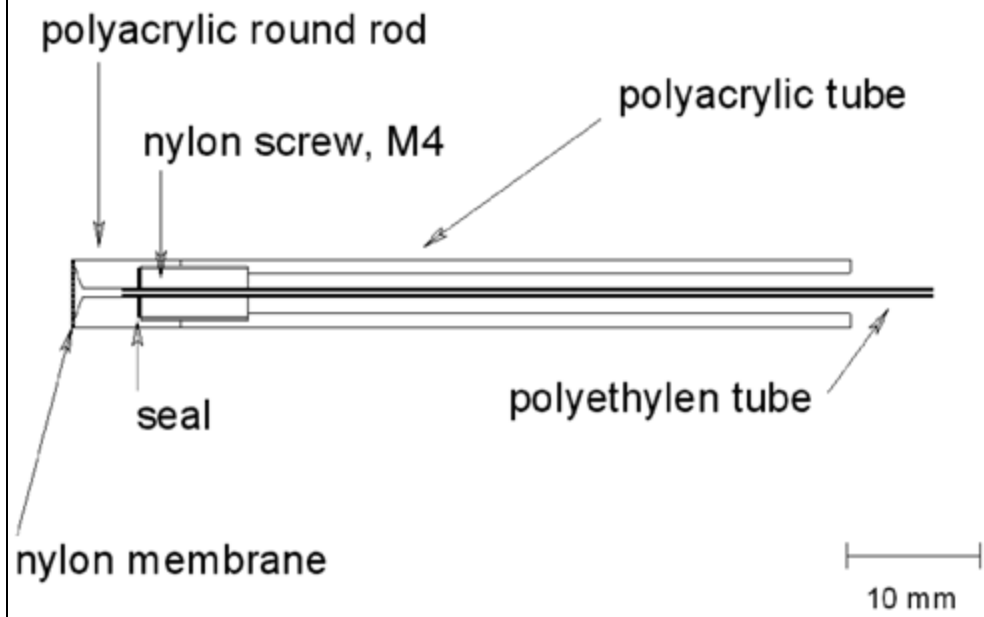
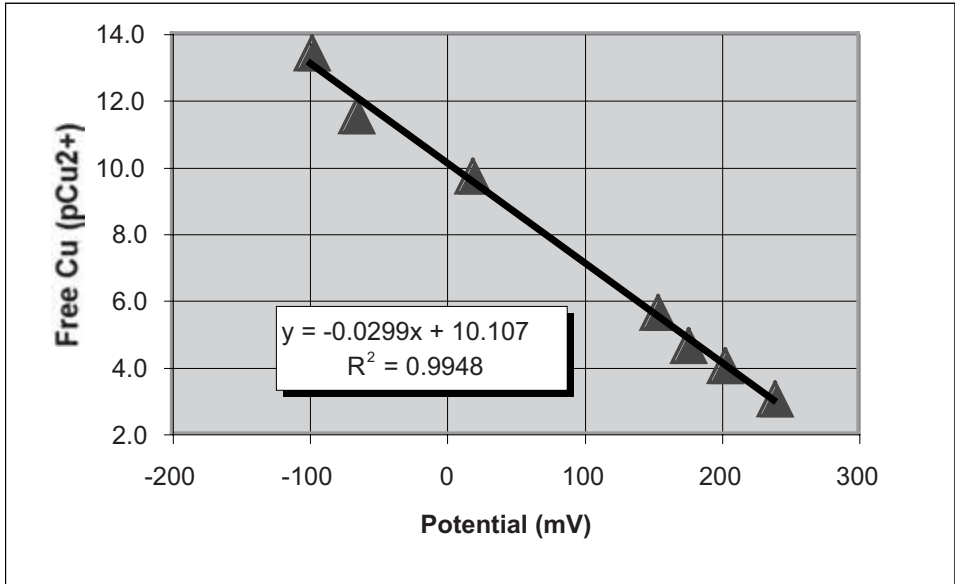
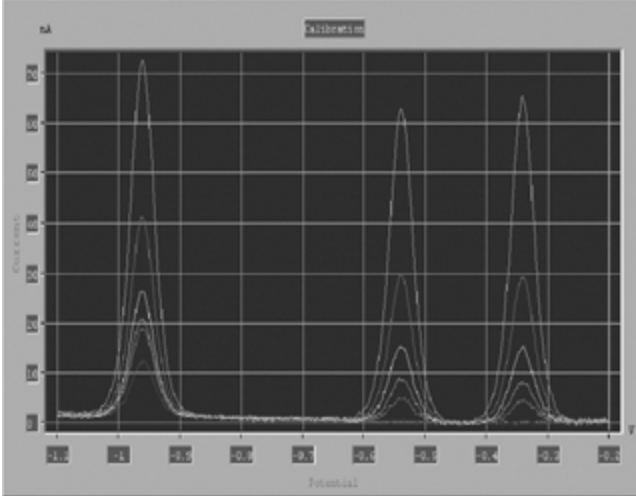

Figure 1: Construction details of the micro suction cup. The polyethylene tube is 21.8 mm long and has an inner diameter of 0.28 mm. For collection of the sample, the tube is connected to the vacuum chamber (see Puschenreiter et al. 2005).

ID	23_Sas-Paszt
Author	Sas-Paszt, Lidia; Stepien, Teresa Research Institute of Pomology and Floriculture, Pomologiczna 18, 96-100 Skierniewice, Poland; lsas@insad.pl; ++48 46 8332021 ext. 235
Parameter	Macro and micro-element concentrations in soil solution
Soil type	Mineral soil from pomological orchards
Plant species	Strawberry, apple, pear
System	Soil experiments in pots and rhizoboxes (greenhouse), and also in the field
Method	Inductively-coupled plasma optical emission spectrometry (ICP-OES)
Method description	Analysis of total element concentrations in soil solution samples with ICP-OES.
Do's, don'ts, potential limitations, untested possibilities	<p>Manufacturers of ICP-OES equipment do not envisage any limitations in the use this method. However, during practical analytical work there are sometimes problems with obtaining a good precision in the determination of individual mineral elements, especially when their concentration is very low. These problems depend on:</p> <ul style="list-style-type: none"> • sensitivity of the given instrument • interference caused by matrices (in soil solution some interference possible from dissolved organic matter). In mineral soils (defined as those containing no more than 5% of organic matter) there are few so-called accompanying ions. It is assumed that they are of little significance, hence interferences related to the influence of matrices are small. • In addition, the ICP-OES method allows so-called background corrections to be made, which enables the effect of the matrix on the analysis results to be considerably reduced. • noise caused by the interference between individual elements • other errors which can occur between the time of sampling and the completion of an analysis. The rate and amount of the sample solution being delivered is constant for a given series of tests. This is guaranteed by the peristaltic pump used for the purpose. The length of time an analysis should take is determined at the stage of method validation to ensure it is optimal for the character of the samples being analyzed. <p><i>Analysis of arsenic, selenium and tin:</i> These elements form volatile hydrides. In order to obtain a significant improvement in the precision of an analysis and limits of detection it is advisable to use a system for generating hydrides.</p> <p><i>Quality assurance:</i> To reduce errors and to control the analytical process in our laboratory we use the following:</p> <ul style="list-style-type: none"> • certified reference materials (CRM) and reference materials purchased from specialized sources • our own reference materials • Statistical methods to assess the quality of analysis results: The Laboratory itself does not carry out statistical analyses of the results obtained for the submitted samples. However, such analyses are performed (during method validation) for the results obtained for the samples of the Laboratory's own reference materials. Statistical

	<p>assessment then forms the basis for characterizing a given analysis method, e.g. its correctness, accuracy or reliability.</p> <ul style="list-style-type: none"> • our own procedures to control the quality of analyses. To this end the Laboratory makes use of the following standards: <ul style="list-style-type: none"> - PN-ISO 5725 cz.1 do 6 „Accuracy (correctness and precision) of measurement methods and results” - PN-ISO 2602 “Estimating the mean value” - PN-ISO 8258+AC1 “Shewhart’s control cards”. <p>For the purpose of monitoring the quality of the analyses carried out by the Laboratory, and to satisfy the requirements of PN-EN ISO/IEC 17025, a general procedure – “Controlling the quality of analyses” (known also as the Standard Operating Procedure) – has been implemented. According to this procedure the Laboratory carries out both internal and external checks of the quality of analyses.</p> <p>Internal checks of the quality of analyses are carried out at two levels. The first level involves:</p> <ul style="list-style-type: none"> - checking the results of analyses of the Laboratory’s own reference material for 2 samples in every analyzed series consisting of no more than 20 samples - checking the results of analyses for parallel samples - checking that the measuring equipment is working properly - monitoring the environmental conditions - The second quality control level involves: <ul style="list-style-type: none"> - checking the results of analyses for samples of known composition - checking the results of analyses for certified reference materials <p>External checks of the quality of analyses are carried out by assessing the results of analyses obtained for samples taking part in inter-laboratory comparisons.</p>
References	<p>Szczepaniak Walenty. 1997. Metody instrumentalne w analizie chemicznej, Instrumental methods of chemical analyses. Wydawnictwo Naukowe PWN, Warszawa 1997.</p> <p>Mercik Stanislaw. 2002. Praca zbiorowa pod redakcją Stanisława Mercika, Chemia Rolna. Podstawy teoretyczne i praktyczne. Basic theoretical and practical aspects of agricultural chemistry. Wydawnictwo SGGW, Warszawa 2002.</p> <p>Procedury Badawcze Centralnego Laboratorium Analitycznego ISK. Analytical Procedures of the Central Analytical Lab at the Research Institute of Pomology and Floriculture in Skierniewice, Poland. 2001. Skierniewice, 2001.</p>
Additional information	<p>Protocols for extractions and measurements (in Polish and English) available on request from the author.</p>

ID	23_Sauve_a
Author	Sauvé, Sébastien Université de Montréal, Department of Chemistry, PO 6128 succ. Centre-Ville, Montréal, QC, Canada, H3C 3J7 sebastien.sauve@umontreal.ca; ++1 514 343-6749
Parameter	Free Cu in soil solution
Soil type	Any soil
System	Extracts to mimic soil solution
Method	Ion-selective electrode potentiometry
Method description	Free Cu ²⁺ is analyzed in 1:10 soil : 0.01 M KNO ₃ extracts using a calibration with dilute Cu salts and an iminodiacetic acid buffer calibration to adjust the free Cu ²⁺ concentration
Do's, don'ts, potential limitations, untested possibilities	<ul style="list-style-type: none"> • Be patient, this is like very slow pH measurements calibrated with home-made buffers. • Applicability at low pH (<4.0) with little or no dissolved organic matter would need to be checked. • Could be used with water extracts but ionic strength ought to be normalized.
References	<p>Sauvé, S.; McBride, M.B.; Hendershot, W.H. 1995. Ion-selective electrode measurements of copper(II) activity in contaminated soils. Archives of Environmental Contamination and Toxicology 29: 373-379.</p> <p>Sauvé, S.; McBride, M.B.; Norvell, W.A.; Hendershot, W. 1997. Copper solubility and speciation of in situ contaminated soils: Effects of copper level, pH and organic matter. Water, Air and Soil Pollution 100: 133-149.</p>
Links	http://dx.doi.org/10.1023/A:1018312109677
Additional information	 <p>Fig. 1. Sample calibration curve</p>

ID	23_Sauve_b
Author	Sauvé, Sébastien Université de Montréal, Department of Chemistry, PO 6128 succ. Centre-Ville, Montréal, QC, Canada, H3C 3J7 sebastien.sauve@umontreal.ca; ++1 514 343-6749
Parameter	Free and labile Cd, Pb and Zn in soil solution
Soil type	Any soil
System	Soil solution extracts
Method	Differential pulse anodic stripping voltammetry and speciation calculations
Method description	Labile Cd, Pb and Zn are analyzed using differential pulse anodic stripping voltammetry in 1 : 10 soil : 0.01 M KNO ₃ extracts. Free metals can then be estimated using chemical equilibrium calculations to partition labile metals into the various expected inorganic ion-pairs.
Do's, don'ts, potential limitations, untested possibilities	<ul style="list-style-type: none"> • Requires some assumptions to derive free metal activities and some experience of electrochemistry and chemical equilibrium calculations. • Could be used with water extracts but ionic strength ought to be normalized.
References	<p>Sauvé, S. 2002. Speciation of metals in soils. In: Allen, H.E. (ed) Bioavailability of Metals in Terrestrial Ecosystems: Importance of Partitioning for Bioavailability to Invertebrates, Microbes and Plants. Society for Environmental Toxicology and Chemistry, Pensacola, FL, USA: pp 7-58.</p> <p>Sauvé, S.; McBride, M.B.; Hendershot, W.H. 1997. Speciation of lead in contaminated soils. Environ. Poll. 98: 149-155.</p> <p>Sauvé, S.; Norvell, W.A.; McBride, M.B.; Hendershot, W. 2000. Speciation and complexation of cadmium in extracted soil solutions. Environ. Sci. Technol. 34: 291-296.</p>
Links	http://www.setac.org/bioavailable.html http://dx.doi.org/10.1016/S0269-7491(97)00139-5 http://dx.doi.org/10.1021/es990202z
Additional information (see also colour plate on p. 526)	<p>Fig. 1.: Polarograms Used for a sample calibration curve</p> 

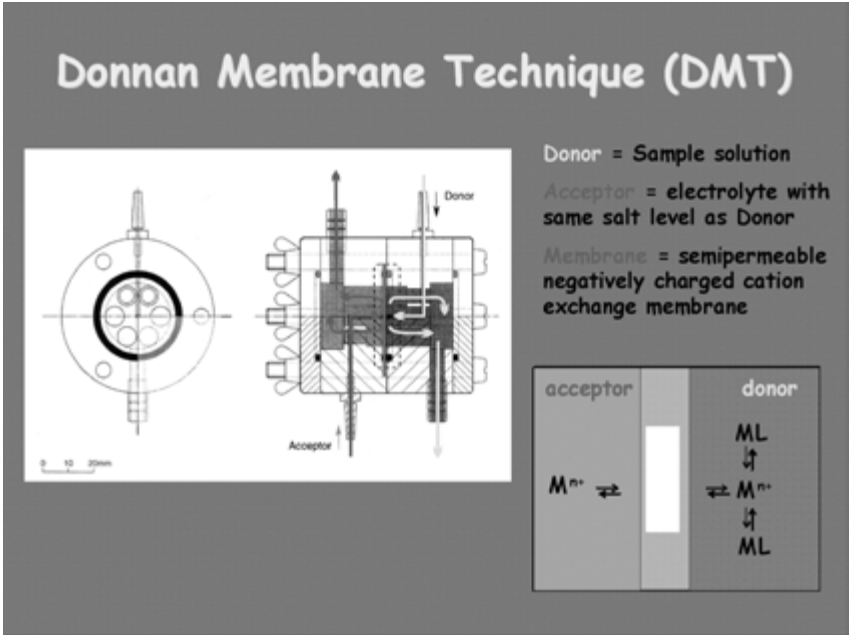
ID	23_Temminghoff
Author	Temminghoff, Erwin J.M. Wageningen University, Department of Soil Quality, P.O. Box 8005 / 6700 EC Wageningen, The Netherlands; erwin.temminghoff@wur.nl
Parameter	Total as well as 'free' metal ion concentration in aqueous (soil) solutions
Soil type	Any soil
System	surface waters, soil solutions, soil columns, sediments
Method	Donnan Membrane Technique (DMT)
Method description (see also colour plate on p. 526)	 <p>In order to determine the 'free' metal ion concentration in the aqueous solutions the so-called Donnan Membrane Technique (DMT) has been developed (Temminghoff et al., 2000). It's a continuous flow system in which the donor side and the acceptor side of the DMT cell are continuously flushed with solution across the membrane. The new cell design allows to reach pseudo equilibrium for the 'free' metal ions via Donnan Equilibrium across a negatively charged ion-exchange membrane within a reasonable time span. The donor solution contains both 'free' and complexed metal ions. Finally, total metal concentrations in the acceptor solution are measured by suitable analytical techniques like inductively-coupled plasma mass spectrometry (ICP-MS).</p>
Do's, don'ts, potential limitations, untested possibilities	<ul style="list-style-type: none"> • The DMT can measure the concentrations in solution in the presence of inorganic and organic complexing agents. • For the measurement of "free" aluminum (Al^{3+}), a recently developed DMT has been tested by measuring Al^{3+} in aluminum-fluoride solutions and gibbsite suspensions. It shows that the Donnan membrane technique can measure free Al^{3+} reliably up to 10^{-9} M (Oste et al., 2002). • Also the DMT is used to measure Cd and Zn binding by purified humic acid solutions (Weng et al., 2002a). It shows that free Cd concentrations as measured by DMT agreed well with Cd-ISE measurements. It is also shown that the Donnan membrane technique could be used at high pH.

	<ul style="list-style-type: none"> We have developed the DMT method further to make it applicable for analysing soil samples (Weng et al., 2001a; 2001b; 2002b). The major development is the linkage of a soil column with the Donnan cell. The operational aspects of the method, including equilibrium time, buffering capacity and correction for differences in ionic strength were investigated and optimized. The method was applied to determine concentrations of free Cu^{2+}, Cd^{2+}, Pb^{2+} and Zn^{2+} in the soil solution of 15 soil samples (pH 2.9-7.1, organic C < 2.9 - 137.4 g kg⁻¹, clay 0.2%-51.6%). Compared with other speciation methods, the Donnan membrane technique has the advantage of allowing the measurement of several elements simultaneously and it minimizes the disturbance of substrate. The detection limit of the Donnan membrane technique, and using ICP-MS for the measurement, is about 10⁻⁹ M. The DMT method can be applied to study the biogeochemical behaviour of metals in soils, sediments and other solid materials. A multi-surface model is used to evaluate the contribution of various sorption surfaces to the control of heavy metal activity in sandy soil samples at pH 3.7 - 6.1 with different sorbent contents. This multi-surface model considers soil as a set of independent sorption surfaces, <i>i.e.</i> organic matter (NICA-Donnan), clay silicate (Donnan) and iron hydroxides (DDL, CD-MUSIC). The activities of Cu^{2+}, Cd^{2+}, Zn^{2+}, Ni^{2+} and Pb^{2+} in equilibrium with the soil have been measured using a Donnan membrane technique. The metal activities predicted by the model agree with those measured reasonably well over a wide concentration range for all the metals of interest except for Pb (Weng et al. 2001b; 2002b). The effect of pH on the bioaccumulation of nickel by plants is opposite when using a nutrient solution or a soil as a growing medium. This paradox can be understood if the pH effect on the bioaccumulation, on the chemical speciation in the soil solution, and on the binding to the soil of Ni are all taken into account (Weng et al., 2003).
References	<p>Temminghoff, E.J.M.; Plette, A.C.C.; van Eck, R.; van Riemsdijk, W.H. 2000. Chemical speciation of heavy metals in aqueous systems by WDMT- Wageningen Donnan Membrane Technique. <i>Anal. Chim. Acta</i> 417: 149-157.</p> <p>Oste, L. A.; Temminghoff, E.J.M.; van Riemsdijk, W.H. 2002. The solid-solution partitioning of organic matter in soils as influenced by an increase in pH or Ca concentration. <i>Environ. Sci. & Technol.</i> 36 : 208-214.</p> <p>Weng, L.; Temminghoff, E.J.M.; van Riemsdijk, W.H. 2002a. Aluminum speciation in natural waters: measurement using Donnan membrane technique and modeling using NICA-Donnan. <i>Water research</i> 36: 4215 - 4226.</p> <p>Weng, L.; Temminghoff, E.J.M.; van Riemsdijk, W.H. 2001a. Determination of the free ion concentration of trace metals in soil solution using a soil column Donnan membrane technique. <i>Eur. J. of Soil Sci.</i> 52: 629-637.</p> <p>Weng, L.; Temminghoff, E.J.M.; van Riemsdijk, W.H. 2001b. Contribution of Individual Sorbents to the Control of Heavy Metal Activity in Sandy Soil <i>Environ. Sci. & Technol.</i> 35: 4436-4443.</p> <p>Weng, L.; Temminghoff, E.J.M.; Lofts, S.; Tipping, E.; van Riemsdijk, W.H. 2002b. Complexation with dissolved organic matter and solubility control of heavy metals in a sandy soil. <i>Environ. Sci. & Technol.</i> 36: 4804-4810.</p> <p>Weng, L.; Lexmond, T.M.; Wolthoorn, A.; Temminghoff, E.J.M.; van Riemsdijk, W.H. 2003. Phytotoxicity and bioavailability of nickel: chemical speciation and bioaccumulation. <i>Environmental Toxicology and Chemistry</i> 22: 2180-2187.</p>
Links	http://www.dow.wau.nl/soil_quality/nieuw/index.htm

ID	23_Zhang_a
Author	Zhang, H. Environmental Science Dept, Lancaster University, Lancaster LA1 4YQ, United Kingdom h.zhang@lancaster.ac.uk; ++44 1524 593899;
Parameter	Total Metal concentrations in soil solution
Soil type	All soil types
System	field soil and microcosm
Method	ICP-MS
Method description	Simultaneous multi-elemental analysis using inductively coupled plasma mass spectrometry (ICP-MS). Soil solution samples can be extracted using Rhizon soil moisture samplers or centrifugation followed by filtration using 0.45µm filter membranes or any other suitable sampling technique (see chapter 1.3.).
Do's, don'ts, potential limitations, untested possibilities	<p><i>Soil solution sampling and storage:</i> All sampling vessels should be acid washed and handled using clean room procedures to avoid contamination. Samples should be acidified using ultrapure acid immediately after sampling.</p> <p><i>Sample preparation:</i> Dilution (at least 10 times) may be needed to reduce the matrix interference for ICP-MS analysis, if the limit of detection is not a problem. High concentrations (ppm) of analyte should be avoided, as it will reduce the life time of the ICP-MS detector.</p> <p><i>ICP-MS operation:</i> Instrument optimization, mass calibration and stability assessment should be performed routinely. A certified reference material freshwater (e.g. SLRS-4) should be analyzed repeatedly throughout the individual runs to assess the accuracy of the analysis.</p>
References	<p>Knight, B. P.; Chaudri, A. M.; McGrath, S. P.; Giller, K. E. 1998. Determination of chemical availability of cadmium and zinc in soils using inert soil moisture samplers. Environ. Pollut. 99: 293-298.</p> <p>Nolan, A. L.; Lombi, E.; McLaughlin, M. 2003. Metal bioaccumulation and toxicity in soils - Why bother with speciation? J. Aust. J. Chem. 56: 77-91.</p>

ID	23_Zhang_b
Author	Zhang, H. Environmental Science Dept, Lancaster University, Lancaster LA1 4YQ, United Kingdom h.zhang@lancaster.ac.uk; ++44 1524 593899;
Parameter	Effective concentrations C_e (As, Zn, Cu, Cd, Pb) in soil solution
Soil type	All soil types
Plant species	<i>Lepidium heterophyllum</i> , <i>Triticum aestivum</i> L., <i>Lepidium sativum</i> , <i>Pteris vittata</i> L.
System	field soils and microcosm
Method	DGT (diffusive gradients in thin-films)
Method Description	<p><i>Sample preparation:</i> Dry and sieved (2mm) soils. Wet them to 50% field capacity (or maximum water holding capacity) for a week and then increase the water content to 80~100% MWHC. Mix the soil well to make a smooth paste or slurry. Equilibrate the soils for 24 hours.</p> <p><i>DGT deployment and Analysis:</i> Smear some soil paste gently onto the exposure window of the DGT device and then press gently onto the soil surface by hand, making sure there is a good contact between the soil and DGT device. After deployment, rinse the DGT device with MQ water and then dry it by gently blotting with a clean tissue paper. Remove the cap of the device to retrieve the resin-gel layer. Place the resin-gel in an acid washed sample tube and add 1ml (or more) of 1M HNO₃ solution. Leave it for at least a day before analysis. Take an aliquot of sample and dilute it 10 times or more and then analyse it by inductively-coupled plasma (ICP) spectrometry or atomic absorption spectrometry (AAS).</p> <p><i>Calculation of the DGT measured F, C_{DGT} and C_E</i></p> <ol style="list-style-type: none"> 1) First calculate the mass of metal accumulated in the resin gel layer (M) using eq. (1) $M = C_{\text{elu}} (V_{\text{acid}} + V_{\text{gel}}) / f_e \quad (1)$ where C_{elu} is the concentration of metals in the 1M HNO₃ elution solution (in $\mu\text{g/l}$), V_{acid} is the volume of HNO₃ added to the resin gel, V_{gel} is the volume of the resin gel, typically 0.15 ml, and f_e is the elution factor for each metal, typically 0.8. 2) The flux of metal measured by DGT (F) can be calculated using eq. (2) $F = M / (tA) \quad (2)$ 3) The concentration of metal measured by DGT (C_{DGT}) at the interface of the DGT unit and soil can be calculated using eq. (3). $C_{DGT} = M \Delta g / (DtA) \quad (3)$ where Δg is the thickness of the diffusion layer (diffusive gel plus the filter membrane), D is the diffusion coefficient of metal in the gel, t is deployment time and A is the exposure window area. 4) Convert C_{DGT} to C_E using eq. (4) $C_E = C_{DGT} / R_{\text{diff}} \quad (4)$ C_E represents the concentration of metal that is effectively available from both soil solution and solid phase labile pool. R_{diff} is the ratio of concentration at the DGT interface to the concentration in bulk soil solution for the diffusion only case. R_{diff} can be calculated using the numerical model of the DGT-soil system, DIFS. 5) Calculating R_{diff} To calculate R_{diff}, you need to use the DIFS model and assume a very large T_c (10^9) and very small K_d (10^{-9}). Other important input parameters are particle concentration (P_c) and porosity (φ). P_c = total mass of all soil particles/the porewater volume φ = volume of porewater/(volume of solid-phase + porewater volume) D_s, diffusion coefficient in soil. $D_s = D_o / (1 - \ln \varphi^2)$. D_o is the diffusion coefficient in

	<p>water.</p> <p>P_c and φ are related. $P_c = d_p(1-\varphi)/\varphi$. Where d_p is the density of the soil particulate matter (commonly assumed as 2.65 g cm^{-3}). If you P_c is known φ can be calculated and vice-versa.</p>
Do's/Don'ts; Potential; Limitations; untested possibilities	<p><i>DGT handling, deployment and retrieval:</i></p> <ul style="list-style-type: none"> • Store DGT devices under moist condition in sealed plastic bags in a refrigerator prior to use. • Do not touch the white filter at the exposure window of the device and do not let it come into contact with anything else. • DGT can be deployed for 2 hours to 4 weeks. For longer the deployment times more soil is needed to avoid depletion of metal at the container surface. A minimum of a 1cm thick soil layer is needed for deployment for a week. Beware of the possibility of exceeding the capacity of the DGT device for metals when choosing the deployment time. Record, to the nearest minute, the deployment time and the temperature of the environment during deployment. If the variation is within $\pm 2 \text{ }^\circ\text{C}$ a mean will suffice. • Retrieval of the resin-gel should be conducted with care to avoid any contamination. Make sure the resin-gel is fully immersed in the HNO_3 solution during elution. The minimum elution time is one day, but there is no upper limit. The samples can be kept for any length of time. <p><i>Limitations:</i> The capacity of the device for metals may not allow long deployment times for soils with very high metal concentrations. DGT is not suitable for deployment on dry soils.</p> <p><i>Untested possibilities:</i> Metal speciation in soil solutions using DGT with different pore sizes to distinguish between labile organic and labile inorganic species.</p>
References	<p>Zhang, H.; Davison, W.; Knight, B.; McGrath, S. 1998. In situ measurements of solution concentrations and fluxes of trace metals in soils using DGT, <i>Environ. Sci. & Technol.</i> 32: 704-710.</p> <p>Hooda, P.; Zhang, H.; Davison, W. 1999. DGT - A new in situ technique for measuring bioavailable trace metals: moisture effects on its performance in soils. <i>J. Soil Sci.</i> 50: 285-294.</p> <p>Davison, W.; Hooda, P.; Zhang, H.; Edwards, A.C. 2000 DGT measured fluxes as surrogates for uptake of metals by plants. <i>Advances in Environ. Res.</i>, Vol. 3: 550-555.</p> <p>Zhang, H.; Zhao, F.J.; Sun, B.; Davison, W.; McGrath, S.P. 2001. A new method to measure effective soil solution concentration predicts copper availability to plants. <i>Environ. Sci. & Technol.</i> 35: 2602-2607.</p> <p>Fitz, W.J.; Wenzel, W.W.; Zhang, H.; Nurmi, J.; Köllensperger, G.; Stipek, K.; Fischerova, Z.; Schweiger, P.; Ma, L.O.; Stingeder, G.J. 2003. Rhizosphere characteristics of the arsenic hyperaccumulator <i>Pteris vittata</i> L. and monitoring techniques for its use in phytoextraction. <i>Env. Sci. Technol.</i> 37: 5008-5014.</p> <p>Nolan, A.; Zhang, H.; McLaughlin, M. J. 2005. Prediction of zinc, cadmium, lead, and copper availability to wheat in contaminated soils using chemical speciation, diffusive gradients in thin films, extraction, and isotopic dilution techniques. <i>J. Env. Qual.</i> 34: 496-507.</p> <p>Zhang, H.; Lombi, E.; Smolders, E.; McGrath, S. 2004. Kinetics of Zn release in soils and prediction of Zn concentration in plants using diffusive gradients in thin films. <i>Env. Sci. Technol.</i> 38: 3608-3613.</p> <p>Nowack, B.; Köhler, S.; Schulin, R. 2004. Use of diffusive gradients in thin films (DGT) in undisturbed field soils. <i>Environ. Sci. Technol.</i> 38: 1133-1138.</p>
Links	Websites: www.lanacs.ac.uk ; www.dgtresearch.ac.uk

ID	23_Zhao
Author	Zhao, Lu ¹⁾ ; Nowack, Bernd ^{2)*} ¹⁾ Institute of Terrestrial Ecosystems, ETH Zurich, Universitätstrasse 16, 8092 Zürich, Switzerland ²⁾ EMPA – Materials Science and Technology, Lerchenfeldstrasse 5, CH-9014 St. Gallen, Switzerland *corresponding author: nowack@empa.ch; ++41 71 274 76 92
Parameter	Concentration of major inorganic anions and low-molecular-weight organic acids in soil solution
Soil type	any
System	Soil solution, rhizosphere soil solution
Method	Ion chromatography (IC)
Method description	<i>Sampling:</i> 1mL filtered sample (e.g. obtained from suction cups). Immediately add 100µL 35% formalin to avoid microbial degradation of the low-molecular-weight organic acids. Keep frozen at -20 °C. <i>Method:</i> Equipment: a DX-320 ion chromatograph system equipped with an electrical conductivity detector and an EG40 eluent gradient generator (Dionex, Sunnyvale, CA). KOH eluent gradient: 0-7 min: 1 mM KOH, 7-25 min: 1 mM to 25 mM KOH, 25-28 min: 25 mM to 60 mM KOH, 28-28.1 min: 60 mM to 1 mM KOH, 28.1-32 min: 1 mM KOH. In total, 32 mins per sample
Do's, don'ts, potential limitations, untested possibilities	<ul style="list-style-type: none"> • The calibration should be prepared freshly for each batch of measurements. A batch should contain less than 35 samples because it takes almost 24 hours to measure each batch. If the samples are kept at room temperature for more than 24 hours, the organic acids may degrade. • Check the chromatograms for each sample carefully because some peaks may not be recognized by the program. • The sample volume can be reduced to 100µL by inserting an inset vial into the sample vials. • The detection limits can be as low as 1µM for organic acids. This value depends the conditions of the instrument and the separation of the peaks.
References	<i>Method described in:</i> Kleikemper, J.; Schroth, M.H.; Sigler, W.V.; Schmucki, M.; Bernasconi, S.M.; Zeyer, J. 2002. Applied and Environmental Microbiology 68: 1516-1523.

Additional information

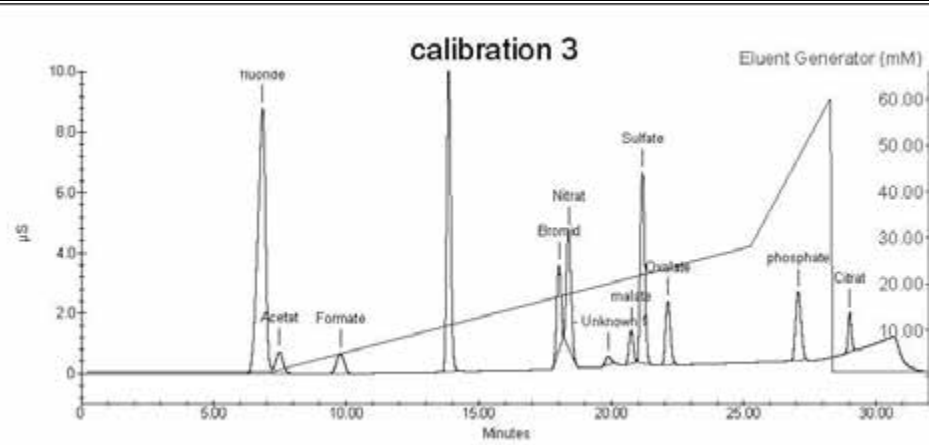

Fig.1: Chromatogram of a calibration of 11 anions and low-molecular-weight acids measured by IC

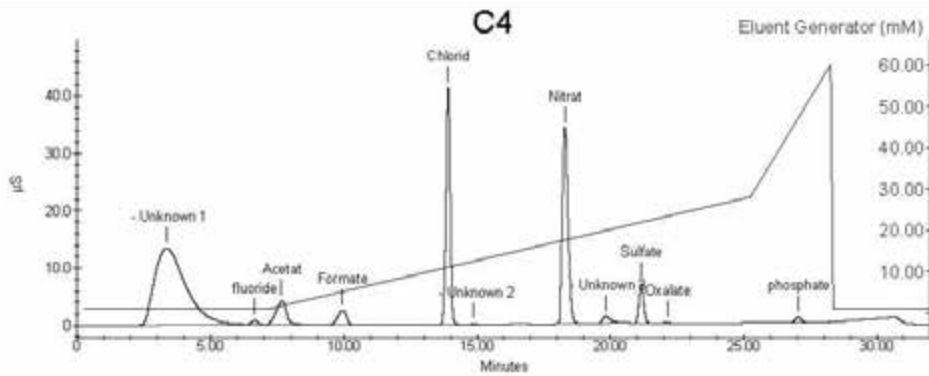

Fig.2: Anions and low-molecular-weight acids in a soil solution sample measured by IC (the first unknown peak is formalin).

ID	31_Delhaize
Author	Delhaize, Emmanuel, Ryan, Peter; CSIRO Plant Industry, GPO Box 1600, Canberra ACT 2601, Australia; Peter.Ryan@csiro.au
Parameter	Aluminium-induced malate exudation
Plant species	Wheat (and others)
System	Hydroponics
Method	Enzymatic assay
Method description	<p><i>Axenic plant culture:</i> Seeds are surface-sterilized with 2.5 % (w/v) of NaOCl with 100 µL 10% (w/v) sodium dodecyl sulphate (SDS) detergent for 20 minutes. Presence of the detergent helps wet the seed. The seed are rinsed thoroughly with several flushes of sterile water. Usually 40 seeds are soaked in 20 mL sterilising solution. Between 5 and 20 seeds are placed in sterilized 125-mL conical flasks containing 40 mL sterile 0.2 mM CaCl₂ solution (pH 4.3). The top of the flasks is covered with sterilized foil and placed on a rotary shaker (120 rpm) at low light and 23 °C for about 5 days.</p> <p><i>Malate efflux from intact seedlings:</i> Seedlings are rinsed with 40 mL of sterile control solution (0.2 mM CaCl₂, pH 4.3) and then incubated on a shaker for 1-2 d in 20-40 mL treatment solution consisting of 0.2 mM CaCl₂ with or without added AlCl₃ (10 to 200 µM, pH 4.3). The treatment solutions can be sampled periodically for malate analysis. Malate will normally be detectable after 6-12 h exposure to 100 µM AlCl₃.</p> <p><i>Malate efflux from excised root segments:</i> 10-20 root segments, 3-5 mm long, are excised from seedlings (pre-culture as described above) and placed in a 5 mL glass sample tube with 1 mL control solution (0.2mM CaCl₂, pH 4.3). After two rinses in control solution 1 mL control solution is added to the segments and the tubes are sealed with parafilm and placed horizontally on a shaker (70 rpm) for 30-60 min. This removes the organic acids released from the cut surfaces of the tissue segments. The tubes are removed from the shaker and the segments rinsed twice in control solution. Then 1 mL treatment solution (0.2 mM CaCl₂ with or without AlCl₃, pH 4.3) is added to the tubes before being resealed and placed on the shaker. Malate efflux from aluminium-tolerant wheat tissue is detectable in the solution after 0.5 to 4 h exposure to 100 µM AlCl₃. Malate is analyzed by HPLC or enzymatic methods.</p> <p><i>Enzymatic assay for malate:</i> (Modified from Gutmann and Wahlefeld, 1974)</p> <p><i>Solutions:</i></p> <ul style="list-style-type: none"> • Hydrazine buffer: Dissolve 11.4 g glycine and 25 ml hydrazine hydrate in 300 mL water and adjust if necessary to ~pH 9.0.. • Nicotinamide adenine dinucleotide (NAD): Dissolve NAD in water (30 mg/mL) and store at 4°C. Prepare fresh for each experiment. • Malate dehydrogenase (MDH): Use enzyme suspension solution just as it arrives from the supplier (usually in 3.2 M (NH₄)₂SO₄ at >1100 U/mg).

	<p>Assay: Add the following to a plastic spectrophotometer cuvette (1 cm path length): 0.75 mL hydrazine buffer; 0.68 mL sample; 50 μL NAD. Mix with pipette and zero the absorbance at 340 nm. Add 5 μL MDH and record the increase in absorbance (ΔABS) at 340 nm after the reaction has gone to completion.</p> <p>Calculations: Concentration of malate in the sample volume is given by $\Delta\text{ABS} \times 338.4 = [\text{malate}] (\mu\text{M})$ Moles of malate released is given by: $\Delta\text{ABS} \times 338.4 \times \text{sample volume (mL)} = \text{nmoles malate}$</p>
Do's, don'ts, potential limitations, untested possibilities	<ul style="list-style-type: none"> • Efflux can be compared along the root: The largest efflux occurs from the apical 0-3 mm of root but this can be compared with the efflux from the next segment 3-6 mm from the root apex or other root zones. • Carefully avoid injury of root segments during transfer and rinsing steps. • Sample can be stored at -20°C before analysis. <p>Possible Modifications:</p> <ul style="list-style-type: none"> • A simple nutrient solution can replace the CaCl_2 solution. • Malate efflux from non-sterile seedlings can also be measured as long as excessive contamination does not occur. Wheat seeds are sterilized as described above and suspended over 1.0 to 2.0 L of 0.2 mM CaCl_2 (pH 4.3) which is gently aerated with a pump. Root tissues can be excised as described above. • The control and treatment solutions can be pH buffered with 2 to 5 mM succinate. Succinate does not chelate the Al^{3+} cations. • Sensitivity can be increased by vacuum-drying the samples to concentrate the organic acids before measuring the malate or by passing the solution through an anion exchange column and eluting in a smaller volume. • Efflux of other organic acids can be measured using a specific enzyme assay or by HPLC. Species other than wheat can also be tested.
References	<p>Delhaize, E.; Ryan, P.R.; Randall, P.J. 1993. Aluminum tolerance in wheat (<i>Triticum aestivum</i> L.). II Aluminum stimulated excretion of malic acid from root apices. <i>Plant Physiology</i> 103: 695-702.</p> <p>Ryan, P.R.; Delhaize, E.; Randall, P.J. 1995. Characterisation of Al-stimulated efflux of malate from the apices of Al-tolerant wheat roots. <i>Planta</i>, 196: 103-111.</p> <p>Gutmann, I.; Wahlefeld, A.W. 1974. L-malate: determination with malate dehydrogenase and NAD. <i>In.</i>: Bergmeyer, H.U. (ed.). <i>Methods of Enzymatic Analysis</i>, Vol 3. Academic Press New York, pp. 1585-1589.</p>

ID	31_Eldhuset
Author	Eldhuset, Toril D. Norwegian Forest and Landscape Institute, P.O. Box 115, N-1431 Ås, Norway toril.eldhuset@skogoglandskap.no; ++47 64 94 80 00
Parameter	Low molecular weight organic acids in root exudates and soil solutions
Soil type	Forest soil (thick fluvial sediments with silty loam and sandy loam texture).
Plant species	Norway spruce (<i>Picea abies</i>), silver birch (<i>Betula pendula</i>)
System	Field soil, soil in rhizoboxes, soda glass beads in sterile microcosms
Method	Ion exclusion HPLC
Method description	<p><i>Sampling:</i> Samples of 50-1800 µL were retrieved from soil by micro suction cups (see 13_Eldhuset_a). Samples of 40 mL were retrieved from the microcosms (11_Sandnes_b) by a syringe.</p> <p><i>Analysis:</i> The HPLC instrument was a HP1100 with a diode array detector, a Micro-Guard® Cation-H pre-column and an Aminex® HPX-87H analytical column, operated at 45 °C. The mobile phase was 10 mM H₂SO₄ at a flow rate of 0,6 mL min⁻¹. 50 µL sample was injected (could be reduced when sample amount was small). The organic components were detected at 210 nm and their UV spectra (190-400 nm) were monitored. The operational detection limits varied from 0.05 to 15 µM for the various acids. Up to 32 organic components were detected, and of these a maximum of 10 organic acids could be identified by comparing observed retention times (up to 45 minutes) and UV spectra with those of the standard solution acids.</p>
Do's, don'ts, potential limitations, untested possibilities	<ul style="list-style-type: none"> • In the microcosms, organic acids may have been adsorbed to the glass beads resulting in reduced recovery. • In the microcosms, the nutrient solution should not contain a higher NO₃ concentration than about 600 µM, otherwise the void peak in the HPLC chromatogram will cover at least the oxalic acid peak. • During sampling from soil, which lasted several hours, organic acids may have been degraded by micro-organisms.
References	<p>Sandnes, A.; Eldhuset, T.D. 2003. J. Plant Nutr. Soil Sci. 166: 660-661. (Please note that in the Fig. 2 caption, the words "negative" and "positive" should change place.)</p> <p>Sandnes, A.; Eldhuset, T.D.; Wollebæk, G. 2005. Organic acids in root exudates and soil solution of Norway spruce and silver birch. Soil Biol. Biochem. 37: 259-269.</p>

ID	13_Englmann
Author	Englmann, Matthias; Frommberger, Moritz; Schmitt-Kopplin, Philippe* GSF - Institute for Ecological Chemistry, <i>Molecular BioGeoanalysis, BioGeomics</i> , Ingolstädter Landstraße 1, D-85764 Neuherberg, Germany; *Corresponding author: schmitt-kopplin@gsf.de; ++49 89 3187 3246
Parameter	Analysis of <i>N</i>-Acylhomoserine Lactones after Alkaline Hydrolysis
System	Bacterial culture media
Method	Anion Exchange Solid Phase Extraction followed by Capillary Zone Electrophoresis Coupled to Mass Spectrometry (CZE-ESI/MS)
Method description	<i>N</i> -Acylhomoserine Lactones (AHLs) in standard solutions and culture supernatants are hydrolyzed under alkaline conditions to produce the corresponding acids (<i>N</i> -Acylhomoserines, completeness of the hydrolysis reaction was examined in nuclear magnetic resonance spectroscopy). The latter are extracted in mixed-mode anion exchange solid phase extraction (SPE). Separation of the acids is performed by capillary zone electrophoresis coupled to mass spectrometry (CZE-ESI/MS) in an ammonium carbonate buffer system at pH 9.2. All AHLs under examination can be detected and identified from the respective mass spectra via the molecular ion ($[M+H]^+$) and a common fragmentation pattern with the most abundant ion at m/z 120. The m/z 120 fragment is used for screening unknown samples for AHLs.
Do's, don'ts, potential limitations, untested possibilities	<ul style="list-style-type: none"> • The method is quantitative, specific and sensitive. The method was found to be quantitative down to a concentration of 0.05 µg/ml (limit of quantification), while the limit of detection was determined with 0.01 µg/ml. • The presented cleanup significantly speeds up the HSL extraction procedure, strongly reduces sample consumption, is more selective compared to the commonly used liquid / liquid extraction and provides a possibility to differentiate quantitatively between the homoserines (as naturally occurring degradation products) besides the intact homoserine lactones.
References	<i>Detailed method description:</i> Frommberger, M.; Schmitt-Kopplin, P.; Kettrup, A. 2005. Analysis of <i>N</i> -Acylhomoserine Lactones after Alkaline Hydrolysis and Anion Exchange Solid Phase Extraction by Capillary Zone Electrophoresis/Mass Spectrometry. <i>Electrophoresis</i> 26:1523-1532.
Links	http://Rhizosphere.gsf.de/topics.php#topic_Nanoanalytics

Additional information

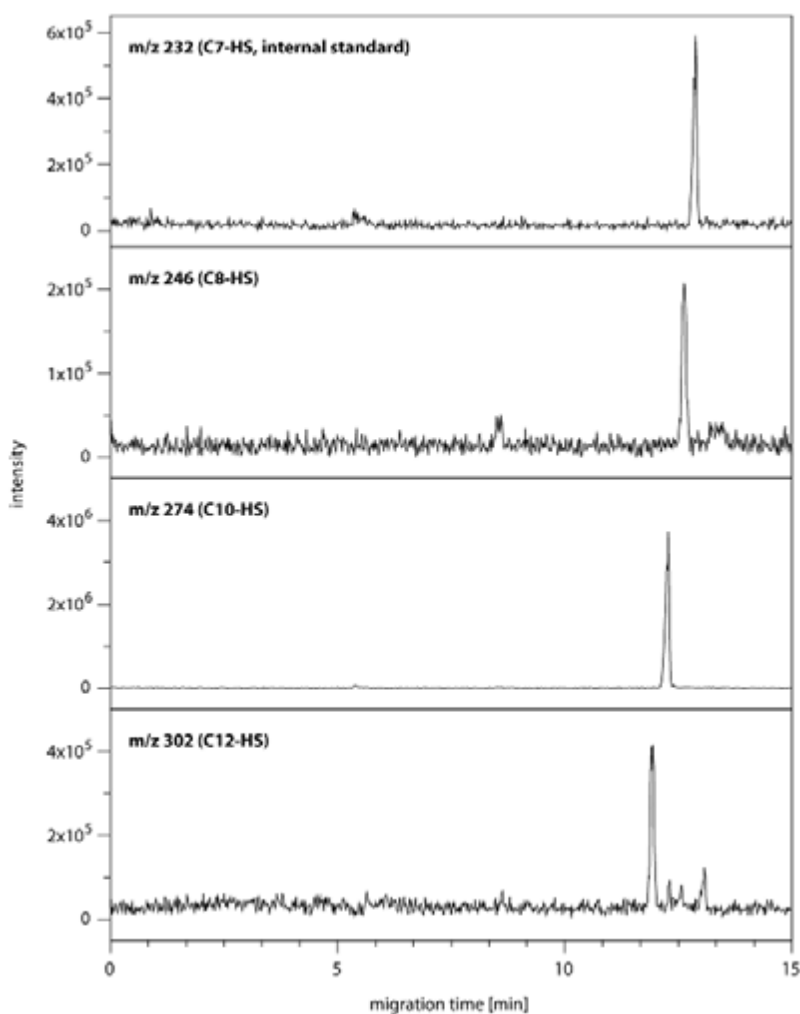
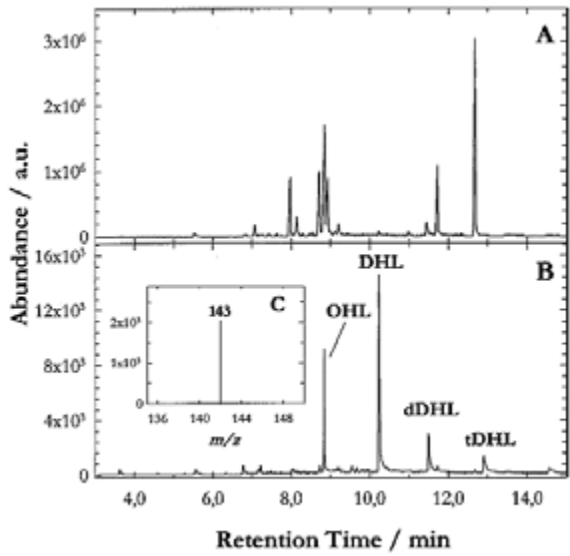
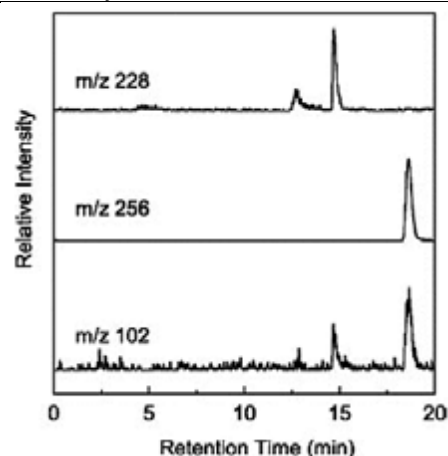

Fig. 1. Real sample measurement in CZE / MS (*B. cepacia* strain Mmi 1537) after alkaline hydrolysis and anion-exchange solid phase extraction under optimized conditions (20% source fragmentation). Selected mass traces for the internal standard, C8-, C10- and C12-HS. (from Frommberger et al., 2005; with permission of Wiley-VCH)

ID	31_Frommberger_a
Author	Frommberger, Moritz; Englmann, Matthias; Gebefügi, Tommaso; Cataldi, Istvan; Bianco, Giuliana; Schmitt-Kopplin, Philippe* GSF - Institute for Ecological Chemistry, <i>Molecular BioGeoanalysis, BioGeomics</i> , Ingolstädter Landstraße 1, D-85764 Neuherberg, Germany *Corresponding author: schmitt-kopplin@gsf.de; ++49 89 3187 3246
Parameter	Analysis of <i>N</i>-Acylhomoserine Lactones
System	Bacterial culture media
Method	Gas Chromatography Coupled to Mass Spectrometry (GC-MS)
Method description	<i>N</i> -Acylhomoserine Lactones (AHLs) in standard solutions and bacterial culture supernatants (chloroform extracts) are analyzed by gas chromatography coupled to mass spectrometry (GC/MS) without derivatization and with an optimized temperature program using a Ph-Me-siloxane column. All AHLs can be detected and identified from the respective mass spectra via the molecular ion ($[M]^+$) and a common fragmentation pattern with the most abundant ion at m/z 143 and other minor peaks at m/z 71, 57, and 43. The m/z 143 fragment is used for screening unknown samples for AHLs in single ion monitoring.
Do's, don'ts, potential limitations, untested possibilities	<ul style="list-style-type: none"> The method is straightforward for indicating the occurrence of AHLs in real samples without using chemical derivatization. Thermal instability of the target molecules and low volatility, however, require high concentrations and thus a preconcentration (extraction with dichloromethane or chloroform) is necessary.
References	<i>Detailed method description:</i> Cataldi, T.R.I.; Bianco, G.; Frommberger, M.; Schmitt-Kopplin, P. 2004. Direct analysis of selected <i>N</i> -acyl-L-homoserine lactones by gas chromatography/mass spectrometry. <i>Rapid Commun. Mass Spectrom.</i> 18: 1341-1344.
Links	http://Rhizosphere.gsf.de/topics.php#topic_Nanoanalytics
Additional information	<p>Fig. 1A. Total ion chromatogram of <i>Burkholderia cepacia</i> strain LA-10 extract.</p> <p>Fig. 1B. SIM (m/z 143) chromatogram of <i>Burkholderia cepacia</i> strain LA-10 extract</p> <p>Fig. 1C. Average SIM mass spectrum of 10.217 to 10.265 min.</p> <p>(from Cataldi et al., 2004; with permission of Wiley-VCH)</p> 

ID	31_Frommberger_b
Author	Frommberger, Moritz; Englmann, Matthias; Schmitt-Kopplin, Philippe* GSF - Institute for Ecological Chemistry, <i>Molecular BioGeoanalysis, BioGeomics</i> , Ingolstädter Landstraße 1, D-85764 Neuherberg, Germany *Corresponding author: schmitt-kopplin@gsf.de; ++49 89 3187 3246
Parameter	Analysis of <i>N</i>-Acylhomoserine Lactones
System	Bacterial culture media
Method	Partial Filling Micellar Electrokinetic Chromatography coupled to Mass Spectrometry (PF-MEKC-ESI/MS)
Method description	<i>N</i> -Acylhomoserine lactones (AHLs) in standard solutions and culture supernatant extracts are analyzed by partial filling micellar electrokinetic chromatography/ electrospray ionization mass spectrometry (PF-MEKC-ESI/MS) under optimized separation and detection conditions (type of surfactant, concentration of the buffer/ surfactant system, partial filling degree, separation and ESI voltages, ESI parameters). All AHLs under examination can be detected and identified from the respective mass spectra via the molecular ion ($[M+H]^+$) and a common fragmentation pattern with the most abundant ion at m/z 102. The m/z 102 fragment is used for screening unknown samples for AHLs. Exemplarily, two AHLs from <i>B. cepacia</i> could be unambiguously determined in a dichloromethane culture supernatant extract (Fig. 1).
Do's, don'ts, potential limitations, untested possibilities	<ul style="list-style-type: none"> AHL analysis by PF-MEKC with mass spectrometric detection is a suitable tool for rapid detection of AHLs in complex microbial extract samples. Bearing in mind the classical way of AHL detection with sensitive reporter strains, the method offers a significant shortening of the analysis time combined with an unmatched specificity. Quantification of AHLs, however, was found to be critical when using PF-MEKC-MS. The method is limited to bacterial extracts, where the concentration of AHLs reaches the operating range of the method (0.1 µg/ml and more).
References	<i>Detailed method description:</i> Frommberger, M.; Schmitt-Kopplin, P.; Menzinger, F.; Albrecht, V.; Schmid, M.; Eberl, L.; Hartmann, A.; Kettrup, A. 2003. Analysis of <i>N</i> -acyl-L-homoserine lactones produced by <i>Burkholderia cepacia</i> with partial filling micellar electrokinetic chromatography - electrospray ionization-ion trap mass spectrometry. <i>Electrophoresis</i> 24: 3067-3074.
Links	http://Rhizosphere.gsf.de/topics.php#topic_Nanoanalytics
Additional information	<p>Fig. 1. Analysis of a bacterial isolate extract (<i>B. cepacia</i>) in PF-MEKC-MS.</p> <p>Top lane, OHL ($M_r = 227$); middle, DHL ($M_r = 255$); bottom, AHL-characteristic fragment at m/z 102.</p> <p>(from Frommberger et al., 2003; with permission of Wiley-VCH)</p>



ID	31_Frommberger_c
Author	Frommberger, Moritz; Englmann, Matthias; Schmitt-Kopplin, Philippe* GSF - Institute for Ecological Chemistry, <i>Molecular BioGeoanalysis</i> , <i>BioGeomics</i> , Ingolstädter Landstraße 1, D-85764 Neuherberg, Germany *Corresponding author: schmitt-kopplin@gsf.de; ++49 89 3187 3246
Parameter	Analysis of <i>N</i>-Acylhomoserine Lactones
System	Bacterial culture media
Method	Nano-Liquid Chromatography Coupled to Mass Spectrometry (NanoLC-ESI/MS)
Method description	<i>N</i> -Acylhomoserine Lactones (AHLs) in standard solutions and bacterial culture supernatants (preconcentrated and non-preconcentrated chloroform extracts) are analyzed with a laboratory-constructed nano-liquid chromatography system coupled to mass spectrometry (NanoLC-ESI/MS). The analysis relies on the combination of analyte preconcentration and separation on a single device: a relatively large sample volume (1–5 µL) is directly loaded onto a laboratory-made, miniaturized (75 µm i. d.) reverse phase nano-liquid chromatography column, connected on-line to a microelectrospray-ionization ion trap mass spectrometer. In a first step the analyte is adsorbed (and so concentrated) at the beginning of the column, and is eluted and selectively separated in a second step by the organic mobile phase. Sample preconcentration follows the mechanisms of solid phase extraction on a nano-scale, while separation takes place according to classical liquid chromatography separation principles.
Do's, don'ts, potential limitations, untested possibilities	<ul style="list-style-type: none"> • The method allows for a selective and sensitive determination of <i>N</i>-acylhomoserine lactones in bacterial culture supernatants. The analytical setup was found to be routinely quantitative down to a concentration of 10 ng/mL (corresponding to a total analyte amount of 10 pg or ca. 50 fmol). The limit of detection was reached at 1 ng/mL (1 pg, ca. 5 fmol). • The columns can be manufactured easily, are simply connected, and used with minimal solvent amounts; this makes this method extremely robust and cost-effective. • The sensitivity of the method makes it suitable for the direct determination of AHLs in culture supernatants without preconcentration, but due to the complexity of the sample, a minimal cleanup is required.
References	<i>Detailed method description:</i> Frommberger, M.; Schmitt-Kopplin, P.; Ping, G.; Frisch, H.; Schmid, M.; Zhang, Y.; Hartmann A.; Kettrup, A. 2004. A simple and robust set-up for on-column sample preconcentration – nano-liquid chromatography – electrospray ionization mass spectrometry for the analysis of <i>N</i> -acylhomoserine lactones. <i>Anal. Bioanal. Chem.</i> 378: 1014-1020.
Links	http://Rhizosphere.gsf.de/topics.php#topic_Nanoanalytics

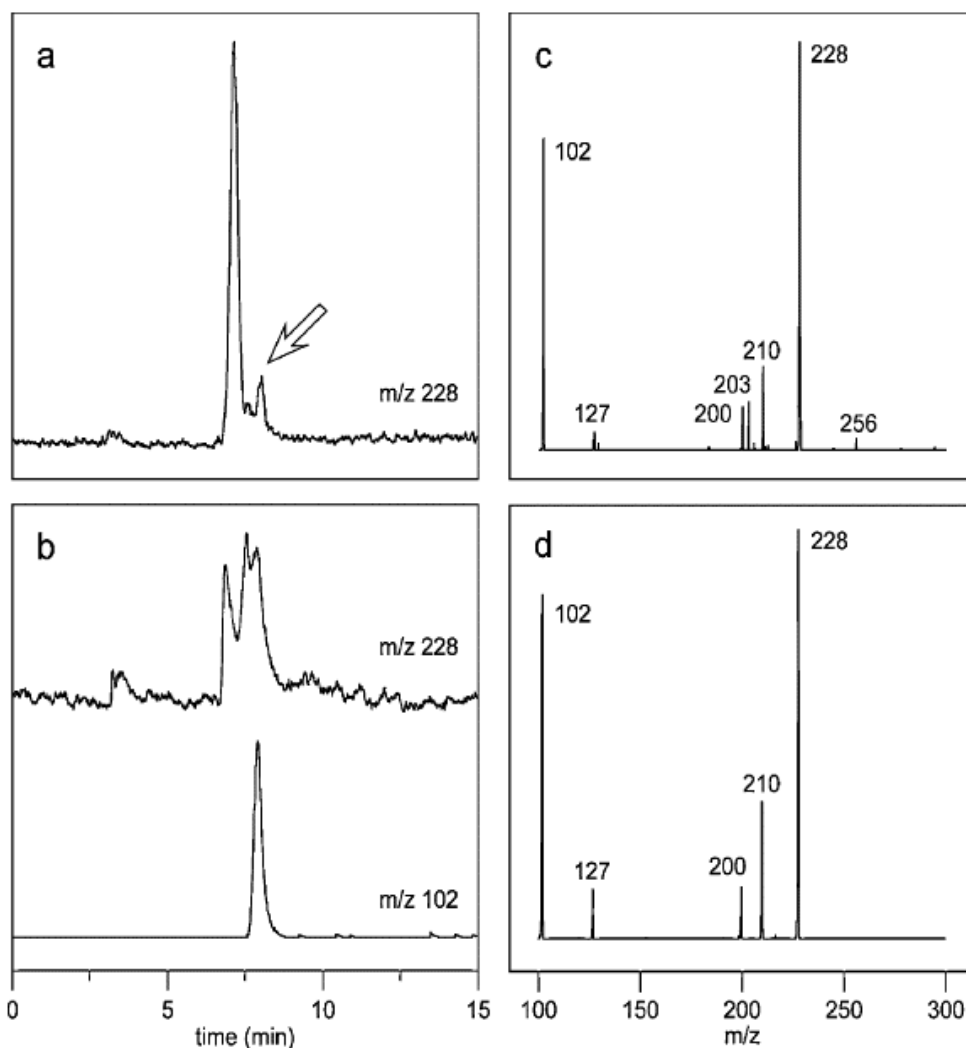

Fig. 1. detection of C8-HSL in a *Burkholderia cepacia* culture supernatant extract. a) selected mass trace of $m/z=228$ in full-scan MS; b) selected mass traces of $m/z=228$ and $m/z=102$ in full scan MS/MS (22.5% collision-induced dissociation on $m/z=228$); c) mass spectrum at the peak maximum of $m/z=102$ in subfigure b); d) mass spectrum at the peak maximum of $m/z=102$ in a reference standard (100 ng/mL) under identical chromatographic and mass spectrometric conditions (from Frommberger et al., 2004; with kind permission of Springer Science and Business Media).

ID	31_Heim_a
Author	Heim, Alexander ¹⁾ ; Hirano, Yasuhiro ²⁾ ; Luster, Jörg ³⁾ ¹⁾ University of Zürich, Department of Geography, Physical Geography, Winterthurerstr. 190, CH-8057 Zürich, Switzerland alexheim@geo.unizh.ch; ++41 44 63 55 183 ²⁾ Kansai Research Center, Forestry and Forest Products Research Institute FFPRI, Kyoto 612-0855, Japan yhirano@affrc.go.jp; ++81 75 611 1201; ³⁾ Swiss Federal Institute for Forest, Snow, and Landscape Research WSL, CH-8903 Birmensdorf, Switzerland; joerg.luster@wsl.ch; ++41 44 739 22 95
Parameter	Organic Acids in Roots and Root Exudates
Plant species	Norway spruce, European Chestnut
System	Hydroponics and Perlite Culture in Growth Chamber
Method	Capillary electrophoresis
Method description	<i>Plant treatment:</i> see 11_Heim_a and 11_Heim_b . <i>Sample preparation</i> <ul style="list-style-type: none"> • Treatment solutions from hydroponic experiments are concentrated by lyophilisation. Excess inorganic anions are removed from the concentrated solutions (see below) --> root exudates. • The pore water from the solid substrate is recovered by crushing the perlite substrate with a mortar and pestle followed by centrifugation. --> root exudates. • Organic acids in roots are sequentially extracted by hot water and EDTA solution. <i>Analysis:</i> All samples are analysed by a capillary electrophoresis (CE) anion method based on a phthalate buffer with negative photometric detection.
Do's, don'ts, potential limitations, untested possibilities	<i>Sample preparation, hydroponic treatment solutions:</i> The large volume of treatment solution leads to dilution of organic acids. Solutions need to be concentrated to yield enough organic acids for analysis. At the same time, inorganic anions which, in high concentrations, can interfere with CE analysis, are enriched as well.. Chloride anions can be removed by passing the samples over Ag ⁺ -saturated cation exchange resin, which at the same time removes most of the cations. This is an important step as CE is only possible for samples with low ionic strength (micromolar concentrations). <i>Sample preparation, solid substrate:</i> Extraction of perlite with 0.01 M NaOH after removal of the pore solutions, increased the yield of organic acids. Further extraction methods were not evaluated. <i>Sample preparation, roots:</i> In roots, water extraction can lead to formation of insoluble Ca oxalate. Therefore, following water extraction, several extraction steps with Na ₂ EDTA are recommended to redissolve Ca oxalate.

	<p><i>Sample preparation, general:</i> Under non-sterile conditions, organic acids are quickly degraded and may not be detectable.</p> <p><i>CE analysis:</i> In the presence of Al, strong Al complexes are formed, which interfere with the oxalate determination by the CE method. This can be prevented by spiking the sample with Na₂EDTA solution. The biggest advantage of CE is the possibility to work with very low sample volumes. On the other hand, detection limits are about 10 times higher than with ion chromatography.</p>
References	<p><i>Absence of organic acids in root exudates in non-sterile hydroponic culture:</i> Heim, A.; Luster, J.; Brunner, I.; Frey, B.; Frossard, E. 1999. Effects of aluminium treatment on Norway spruce roots: Aluminium binding forms, element distribution, and release of organic substances. Plant Soil 216: 103-116.</p> <p><i>Analysis of organic acids in roots and root exudates (hydroponic culture):</i> Heim, A.; Brunner, I.; Frey, B.; Frossard, E.; Luster, J. 2001. Root exudation, organic acids, and element distribution in roots of Norway spruce seedlings treated with aluminium in hydroponics. J. Plant Nutr. Soil Sci. 164: 519-526.</p> <p><i>Measurement of organic acids in perlite pore water:</i> Heim, A.; Brunner, I.; Frossard, E.; Luster, J. 2003. Aluminum Effects on Picea abies at Low Solution Concentrations. Soil Sci. Soc. Am. J. 67: 895-898.</p>

ID	31_Heim_b
Author	Heim, Alexander ¹⁾ ; Luster, Jörg ²⁾ ¹⁾ University of Zürich, Department of Geography, Physical Geography, Winterthurerstr. 190, CH-8057 Zürich, Switzerland alexheim@geo.unizh.ch; ++41 44 63 55 183 ²⁾ Swiss Federal Institute for Forest, Snow, and Landscape Research WSL, CH-8903 Birmensdorf, Switzerland; joerg.luster@wsl.ch; ++41 44 739 22 95
Parameter	Phenolic Substances in Roots and Root Exudates
Plant species	Norway spruce
System	Hydroponics and Perlite Culture in Growth Chamber
Method	Total phenolics: colorimetric assay Root phenolics: Reversed-phase liquid chromatography (RPLC) Fluorescence of root exudates
Method description	<i>Plant treatment:</i> See 11_Heim_a and 11_Heim_b <i>Sample preparation:</i> <ul style="list-style-type: none"> Hydroponic treatment solutions (--> root exudates) are analysed directly or after suitable concentration (freeze drying). The pore water of the solid substrate (--> root exudates) is recovered by crushing the perlite substrate with a mortar and pestle followed by centrifugation. Fresh root material is sequentially extracted, first with 1 M NH₄Cl to obtain an exchangeable fraction, then with 0.01 M HCl. Lyophilized root material is sequentially extracted, first with methanol to yield a soluble fraction, then with NaOH to yield a cell-wall bound fraction. <i>Analysis of total phenolics (all samples)</i> Colorimetric assay using the Folin-Denis reagent. <i>Individual phenolic substances (soluble and cell-bound root fractions)</i> RPLC using C18 material. Different elution systems were used for soluble and cell-bound root fractions. <i>Fluorescence spectroscopy (hydroponic treatment solutions)</i> Total luminescence spectra are recorded to qualitatively show complexation of Al by phenolic ligands (see 33_Luster).
Do's, don'ts, potential limitations, untested possibilities	<i>Analysis of total phenolics</i> Phenolics in exudates may be in low concentrations. Therefore, without an efficient exudate collection technique including sample enrichment, only bulk analyses are possible. Limitations of the Total phenolics method include: reduced reactivity of phenolic groups in ortho position of an acid group (e.g. salicylic acid). Very different phenolics react with the reagent, which makes it difficult to quantify phenolic mass or phenolic C with this method. Use p-hydroxy-benzoic acid as general standard rather than phenol – it gives the same absorption, but is less toxic and easier to handle. For soluble and cell-bound root fractions (analysis of the 200 times and 20 times, respectively, diluted extracts) catechin and ferulic acid, respectively, are used as

	<p>standards.</p> <p><i>RPLC analysis of root extracts</i> Identification of individual substances in the RPLC traces is performed by comparing retention times with those of individual standards and confirming the assignment by standard addition. Generally, only a part of the signals can be identified. For promising standards see references below.</p>
References	<p><i>Original method for total phenolics:</i> Swain, T.; Hillis, W.E. 1959. The phenolic constituents of <i>Prunus domestica</i>. I. The quantitative analysis of phenolic constituents. J. Sci. Food Agric. 10: 63-68.</p> <p><i>Measurement of total phenolics in treatment solutions, NH₄Cl and HCl extracts of root, fluorescence of root exudates:</i> Heim, A.; Luster, J.; Brunner, I.; Frey, B.; Frossard, E. 1999. Effects of aluminium treatment on Norway spruce roots: Aluminium binding forms, element distribution, and release of organic substances. Plant Soil 216: 103-116.</p> <p><i>Extraction of phenolics from spruce roots and RPLC analysis:</i> Münzenberger, B.; Heilemann, J.; Strack, D; Kottke, I.; Oberwinkler, F. 1990. Phenolics of mycorrhizas and nonmycorrhizal roots of Norway spruce. Planta 182: 142-148.</p> <p>Heim, A. 2000. Chelating organic substances in roots and root exudates and their potential role in aluminium resistance of Norway spruce (<i>Picea abies</i> [L.] Karst.). Thesis Swiss Federal Institute of Technology ETH Nr. 13807.</p>

ID	31_Hirano
Author	Hirano, Yasuhiro ¹⁾ ; Brunner, Ivano ²⁾ ¹⁾ Kansai Research Center, Forestry and Forest Products Research Institute FFPRI, Kyoto 612-0855, Japan yhirano@affrc.go.jp; ++81 75 611 1201; ²⁾ Swiss Federal Institute for Forest, Snow and Landscape Research WSL, CH-8903 Birmensdorf, Switzerland ivano.brunner@wsl.ch; ++41 44 739 22 84
Parameter	Callose concentrations in tree roots
Soil type	Acid forest soils
Plant species	Norway spruce, Poplar, Chestnut
System	Hydroponics, Sand culture, Field
Method	Fluorescence spectroscopy
Method description	<i>Sample preparation</i> Fresh root tips are fixed in ethanol to remove auto-fluorescing substances. <i>Extraction of callose in roots</i> Callose in homogenized roots is extracted with 1M NaOH at 80°C for 15 min to solubilize callose. After centrifugation, the supernatant is assayed for callose. <i>Callose assay</i> The reaction mixture containing the supernatant, 0.1% aniline blue, 1M HCl and 1M glycine-NaOH buffer (pH 9.5) are incubated for 20 min at 50 °C and then 30 min at root temperature. Callose is quantified spectrofluorometrically.
Do's, don'ts, potential limitations, untested possibilities	<i>Background fluorescence of roots</i> <ul style="list-style-type: none"> • Especially for tree roots, we should consider background fluorescence (fluorescence intensity without aniline blue stain) that interferes with callose measurement. This problem can be mitigated by ethanol or PVPP washing of the roots before extraction. • It is necessary to subtract the background fluorescence of roots without aniline blue stain for every root samples. • The roots of chestnut which have high contents of phenolic substances have higher background values than spruce and poplar. <i>Optimization for callose assay</i> The amount of root materials and aniline blue stain should be optimized for each tree species. In spruce and poplar seedlings under controlled conditions, 20 mg fresh roots in 1 mL NaOH extraction are optimal.
References	<i>Methods of callose measurement in tree roots:</i> <i>Controlled conditions:</i> Hirano, Y.; Graf Pannatier, E.; Zimmermann, S.; Brunner, I. 2004. Induction of callose in roots of Norway spruce seedlings after short-term exposure to aluminum. <i>Tree Physiol.</i> 24:1279-1283. <i>Field conditions</i> Wissemeier, A.H.; Hahn, G.; Marschner, H. 1998. Callose in roots of Norway spruce (<i>Picea abies</i> (L.) Karst.) is a sensitive parameter for aluminum supply

	<p>at a forest site (Höglwald). Plant Soil 199:53-57.</p> <p>Hirano, Y.; Brunner, I. 2006. Quantitative determination of callose in tree roots. J Plant Physiol. 163: 1333-1336.</p> <p>Hirano, Y.; Walthert, L.; Brunner, I. 2006. Callose in root apices of European chestnut seedlings; a physiological indicator of aluminum stress. Tree Physiol. 26: 431-440.</p> <p><i>Methods of callose measurement in cells and roots in crop plants</i></p> <p>Kauss, H. 1989. Fluorometric measurements of callose and other 1,3-β-glucans. In: Linskens, H.F.; Jackson, J.F. (eds.) Plant Fibers. Springer-Verlag, Berlin, Germany. pp 127-137.</p> <p>Kauss, H. 1992. Callose and callose synthase. In: Gurr, S.J.; McPherson, M.J.; Bowles, D.J. (eds.) Molecular Plant Pathology. Volume II. A Practical Approach. Eds. Oxford University Press, New York, U.S.A. pp 1-8.</p> <p>Kauss, H. 1996. Callose synthesis. In: Smallwood, M.; Knox, J.P.; Bowles, D.J. (eds.) Membranes: Specialized Functions in Plants. BIOS Scientific Publishers Ltd, Oxford, U.K. pp 77-92.</p> <p>Köhle, H.; Jeblick, W.; Blaschek, F.; Kauss, H. 1985. Chitosan-elicited callose synthesis in soybean cells as a Ca²⁺-dependent process. Plant Physiol. 77: 544-551.</p>
Links	A more detailed protocol for extractions and measurements is available on request from the author.

ID	31_Jansa_a
Author	Jansa, Jan ETH Zurich, Plant Sciences, Eschikon 33, CH – 8315 Lindau (ZH), Switzerland; jan.jansa@ipw.agrl.ethz.ch; ++41 52 3549216
Parameter	Chitin in roots colonized by arbuscular mycorrhizal fungi (AMF)
Plant species	any plant with nonwoody roots
System	pot experiment samples
Method	HPLC analysis of hydrolysate
Method description	<p>This method is based on measurement of glucosamine liberated from chitin-containing cell walls of fungi colonizing plant roots. As chitin is not present in plant cells, this method allows quantification of fungal biomass in plant root samples.</p> <p>The roots are dried and milled in a Micro-dismembrator (ball mill with two balls in each container). Then, 30 mg of the biomass is hydrolyzed with 5mL 0.2 M KOH for 1h at 100°C, centrifuged and supernatant discarded. The debris is washed 3 more times with KOH. Weight of the hydrolyzed sample is estimated (should be around 11mg) and hydrolyzed with 135 µL 72% H₂SO₄ + 1.615 mL water for 4 hours at 100°C. The hydrolysate is neutralized with BaOH (0.15 M) before 10 µL Glutamin (2.5 mM; internal standard) is added. Sample is filtered 0.2 µm nitrocellulose filter and 5ml evaporated in vacuum centrifuge, resuspended in 1 mL water and filtered through 0.45 µm filter. The samples are then derivatized with FMOc (fluorenylmethyl-chloroformate): 200 µL sample, 50 µL borate buffer pH 6.3, 250 µL FMOc in acetone. After 1 min, 1 mL n-heptane is added, the sample is shaken, heptane discarded, 50 µL of the sample transferred into an IC vial (glass vial with Teflon coated lid), 950 µL water added, and 100 µL injected into the HPLC equipped with reverse phase column and fluorescence detector. If electrochemical detector is used, no derivatization is needed.</p>
Do's, don'ts, potential limitations, untested possibilities	<ul style="list-style-type: none"> • This is a non-specific estimation of all fungal biomass in a sample. For estimation of biomass of arbuscular mycorrhizal fungi (AMF) in the roots, only samples from pot experiments are useful. Field samples contain also a lot of other endophytic fungi that will bias the analysis. • This is a very laborious method with variable results for different plant (due to different hydrolysis efficiency of roots of different plant species). Therefore, comparison of different plant species (or comparison of plant roots sampled at different times) is difficult.
References	<p><i>Comparison of 3 methods to quantitatively estimate AMF colonization in roots (yellow pigment, chitin and sterols):</i> Schmitz, O.; Danneberg, G.; Hundeshagen, B.; Klingner, A.; Bothe, H. 1991. Quantification of vesicular-arbuscular mycorrhiza by biochemical parameters. <i>Journal of Plant Physiology</i> 139: 106-114.</p> <p><i>Chitin estimation after derivatization of glucosamine:</i> Ekblad, A.; Nasholm, T. 1996. Determination of chitin in fungi and mycorrhizal roots by an improved HPLC analysis of glucosamine. <i>Plant Soil</i> 178: 29-35.</p>
Add. Inf.	More details available from the author.

ID	31_Jansa_b
Author	Jansa, Jan ETH Zurich, Plant Sciences, Eschikon 33, CH – 8315 Lindau (ZH), Switzerland; jan.jansa@ipw.agrl.ethz.ch; ++41 52 3549216
Parameter	Fatty acids
Soil type	not tested by the author
Plant species	cereals, legumes, leek (model host plants for AMF research)
System	pot experiments
Method	Assessment of fatty acid methyl ester (FAME) profiles in roots colonized by arbuscular mycorrhizal fungi (AMF)
Method description	<p>This method allows detecting different fatty acids (FA) being present in plant roots in order to identify and quantify so called signature fatty acids of arbuscular mycorrhizal fungi (AMF) colonising the roots. It is an efficient method for quantification of biomass of a range of AMF species (though not all) within the roots. The FA are subjected to separation by gas chromatography in a form of fatty acid methyl ester (FAME) after methylation.</p> <p><i>Sample preparation and storage:</i> Roots are separated from the soil (growth substrate), and homogenized in liquid nitrogen. Homogenized root biomass is lyophilized at -50°C for 2 days, then the temperature is raised to -15°C for 1 day and at -5°C for another day. Finally, the temperature is raised to +5°C for 2 hours. The samples should be stored at max. -20°C, if possible at -80°C.</p> <p><i>Extraction and analysis:</i> About 0.05 g of the dry root powder is spiked with internal standard (e.g. 0.3 mg undecanoic acid, dissolved in 10 µl of hexane) to enable correction for losses during extraction and also calculation of the extraction efficiency. The lipids are extracted with chloroform-methanol extraction mixture (2:1 v:v; “Folch’s mixture) for 30 min, before 1% NaCl is added and centrifuged at 2000g for 10 min. The lower phase containing the lipids is filtered through organics resistant Millex filter, evaporated to dryness in vacuum, and derivatized by adding 10% solution of methanol in TMCS (trimethylchlorosilane). The solution is evaporated to dryness again and the FAME are dissolved in 100 µl hexane. FAME composition is analyzed on GC equipped with a capillary column Omegawax 250, 30 m X 0.25 mm ID, 0.25 µm coating and flame ionisation detector (FID).</p>
Do’s, don’ts, potential limitations, untested possibilities	<ul style="list-style-type: none"> • All (!!!) reagents must be of analytical quality, including the acetone and ethanol for cleaning of vials. All vials and tubes should be washed with hot water, acetone and hexane before putting the samples to it, in order to prevent contamination (GC detects compounds in pmol concentrations!!!) • Methanol is an extremely hazardous chemical, being absorbed through skin and respiratory organs. Always wear gloves and prevent inhalation of any chemical (also TMCS and chloroform are quite nasty guys causing narcosis, throat burning etc.). • Never use oil or membrane-driven vacuum pumps as these are efficiently destroyed by the organic solvent! Only use a water-driven vacuum pump. • The method can also be adapted for extraction of lipids from fresh plant

	<p>roots. However, then the throughput will be lower than in this presented method. Similar methods have been used for FAME analysis of soils (Olsson et al., 1995), but possible interferences with bacteria must be taken into account. This methods can also be modified to analyse composition of FA in different lipid classes (phospholipids, neutral lipids) separated by either column or thin layer chromatography. Separating phospholipid and neutral lipid fractions before methylation allows quantification of active biomass vs. storage lipid fraction of the AMF.</p>
References	<p><i>Root extraction and sample preparation:</i> Jansa, J.; Gryndler, M.; Matucha, M. 1999. Comparison of the lipid profiles of arbuscular mycorrhizal (AM) fungi and soil saprophytic fungi. <i>Symbiosis</i> 26: 247-264.</p> <p><i>FAME in soil:</i> Olsson, P.A.; Baath, E.; Jakobsen, I.; Soderstrom, B. 1995. The use of phospholipid and neutral lipid fatty acids to estimate biomass of arbuscular mycorrhizal fungi in soil. <i>Mycological Research</i> 99: 623-629.</p> <p><i>Use of polar and neutral lipids for AMF quantification:</i> Olsson, P.; Johansen, A. 2000. Lipid and fatty acid composition of hyphae and spores of arbuscular mycorrhizal fungi at different growth stages. <i>Mycological Research</i> 104: 429-434.</p> <p><i>Tracing root colonization by AMF and fungal pathogen based on lipid analysis:</i> Larsen, J.; Bodker, L. 2001. Interactions between pea root-inhabiting fungi examined using signature fatty acids. <i>New Phytologist</i> 149: 487-493.</p>
Additional information	Further details available from the author.

ID	31_Jansa_c
Author	Jansa, Jan ETH Zurich, Plant Sciences, Eschikon 33, CH – 8315 Lindau (ZH), Switzerland; jan.jansa@ipw.agrl.ethz.ch; ++41 52 3549216
Parameter	Isoenzymes and Total proteins
Soil type	none tested by the author
Plant species	maize, clover, leek (model plants in AMF research)
System	pot experiments
Method	Isoenzyme and total protein profiles of plant roots colonized by arbuscular mycorrhizal fungi (AMF)
Method description	<p>This method describes how to perform non-denaturing and denaturing protein electrophoresis on polyacrylamide gels (PAGE). Electrophoresis sandwiches are assembled according to manufacturer's recommendations and two-layered gel is cast: Separating gel (7.5% polyacrylamide for most applications), and upper stacking gel (usually 4% polyacrylamide). The major difference between non-denaturing and denaturing PAGE is presence of SDS in the latter. Also sample preparation and running conditions differ between the two types of PAGE – while a composite buffer containing protease inhibitor, mercaptoethanol etc. is protecting nondenaturing (=native) PAGE samples until they are loaded onto the gel, the samples for denaturing PAGE are cooked in presence of SDS in order to unfold proteins and disintegrate tertiary structure (supramolecular complexes). Nondenaturing PAGE also requires more efficient cooling of the gel during the run, the temperature should optimally stay within the range 2-8°C.</p> <p>The separation gel with 7.5% acrylamide concentration will, however, hardly detect polypeptides smaller than 30 KD. To achieve a resolution over a wider molecular weight range for a more comprehensive profiling of proteins, the use of gradient gels with acrylamide concentrations of e.g. 7-15% or the Tricine buffer system described by Schagger and von Jagow or two dimensional separation techniques are recommended.</p> <p>Nondenaturing PAGE gels are stained with a specific dye mixture (similar to histochemical staining usually containing enzyme substrate and detection dye). Denaturing PAGE gels are usually stained with Coomassie Blue or silver for unspecific detection of proteins.</p> <p>For evaluation of the line pattern obtained either from AMF spores or colonized roots, either presence/absence of specific bands is used (may be coupled with densitometry analysis to obtain (semi)quantitative results), or multivariate statistical approaches are employed.</p>
Do's, don'ts, potential limitations, untested possibilities	<ul style="list-style-type: none"> • Cut bottom right corner of the gel to be able to position the gel properly after staining. • The method needs modifications according to different hardware used. Follow manufacturer instructions!!!
References	<p><i>Recipes for both denaturing and nondenaturing (native) PAGE:</i> Hoefer. Protein electrophoresis. Application guide. Hoefer Scientific Instruments, San Francisco CA, 1994, pp106.</p> <p>Schagger, H.; von Jagow, G. 1987. Tricine-sodium dodecyl sulfate-polyacrylamide gel electrophoresis for the separation of proteins in the range from 1 to 100 kDa. Anal Biochem. 166(2):368-79).</p>

	<p><i>Comprehensive review of isoenzyme use with AMF:</i> Rosendahl, S.; Sen, R. 1992. Isozyme analysis of mycorrhizal fungi and their mycorrhiza. <i>Methods in Microbiology</i> 24: 169-194.</p> <p><i>Specific isozymes for AMF species:</i> Tisserant, B.; Brenac, V.; Requena, N.; Jeffries, P.; Dodd, J.C. 1998 The detection of <i>Glomus</i> spp. (arbuscular mycorrhizal fungi) forming mycorrhizas in three plants, at different stages of seedling development, using mycorrhiza-specific isozymes. <i>New Phytologist</i> 138: 225-239 .</p> <p><i>Recipes for a number of isoenzyme system stainings :</i> Zervakis, G.; Sourdis, J.; Balis, C. 1994. Genetic variability and systematics of eleven <i>Pleurotus</i> species based on isozyme analysis. <i>Mycological Research</i> 98: 329-341.</p> <p><i>Use of total protein profiles for discriminating AMF species:</i> Avio, L.; Giovannetti, M. 1998. The protein pattern of spores of arbuscular mycorrhizal fungi: comparison of species, isolates and physiological stages. <i>Mycological Research</i> 8: 985-990.</p>
Additional information	<p>This approach has multitude of uses such as e.g. detection (and activity quantification) of proteins and/or peptides of plant origin or can be used for detection of microbes according to their signature bands. Further details available from the author.</p>

ID	31_Jones_a
Author	Jones, Davey School of Agricultural and Forest Sciences, University of Wales, Bangor, Gwynedd, LL57 2UW, UK d.jones@bangor.ac.uk; ++44 1248 382579
Parameter	Total free amino acids in soil solution and soil extracts
Soil type	Any soil
System	Any system where soil solution can be recovered
Method	Fluorometric determination
Method description	<p><i>Reagents:</i></p> <ol style="list-style-type: none"> 1. Borate buffer (pH 9.5): <ol style="list-style-type: none"> a. Make up 0.02 M sodium borate ($K_2B_4O_7$): 3 g per 500 mL b. Add solid KOH pellets (about 7 to 10) to get pH 9.5 2. OPA-MET reagent <ol style="list-style-type: none"> a. Dissolve 50 mg of o-phthaldialdehyde into 5 mL of HPLC grade methanol b. To (a), add 100 μL of β-mercaptoethanol in a fume cupboard c. Add (b) to 200 mL of borate buffer and mix d. Let the OPA-MET reagent stand in the dark for 45 minutes before use <p><i>Procedure:</i></p> <ol style="list-style-type: none"> 1. Set excitation wavelength to 340 nm 2. Set emission wavelength to 440 nm 3. Set slit width to between 10 to 20 nm 4. Add 20 μL of the sample to a fluorimeter cuvette 5. Add 2 mL of OPA-MET reagent 6. Wait 1 min and take down reading 7. Use 10 μM glycine as a standard
Do's, don'ts, potential limitations, untested possibilities	<ul style="list-style-type: none"> • An easy method to use. We have never had any problems. • Use distilled water as a control. • The OPA-MET reagent has a background fluorescence which should be subtracted. • The limit of detection is about 50 to 100 nM. • For evaluation of possible interferences with NH_4^+, see reference below.
References	Jones, D.L.; Farrar, J.F.; Owen, A.G. 2002 Simple method to enable the high resolution determination of total free amino acids in soil solutions and soil extracts. <i>Soil Biology and Biochemistry</i> 34: 1893-1902.

ID	31_Jones_b																					
Author	Jones, Davey School of Agricultural and Forest Sciences, University of Wales, Bangor, Gwynedd, LL57 2UW, UK d.jones@bangor.ac.uk; ++44 1248 382579																					
Parameter	Total phenols in soil solution and soil extracts																					
Soil type	Any soil																					
Plant species	Any vegetation																					
System	All systems																					
Method	Colorimetric Assay																					
Method description	<p><i>Assay procedure for spectrophotometer:</i></p> <ol style="list-style-type: none"> 1. Make up some saturated sodium carbonate (Na_2CO_3). To do this keep adding solid Na_2CO_3 to distilled water until no more will dissolve. Store at room temperature. Crystals will appear over time, however, this is nothing to worry about as long as you take the liquid layer off the top for analysis. 2. Add 0.7 ml of your sample or standard to a 1.5 ml eppendorf tube 3. Add 50 μl of Folin and Ciocalteu's Reagent (stored in fridge: made by Sigma) 4. Close cap of microfuge tube, mix on vortex and let stand for 3 minutes 5. Add 100 μl of saturated sodium carbonate solution (Na_2CO_3) 6. Add 150 μl of distilled water, mix well and let stand for 10-20 mins. 7. A blue colour should develop if you have phenols. Blanks should go colourless. If you see precipitate (this is due to Ca), put the samples in a microfuge and spin for 2-3 mins at 14,000 rpm, recover the supernatant and read absorbance immediately. 8. Transfer 0.8 ml to a cuvette and read absorbance at 725 nm 9. Prepare standards with phenol in the following range (0-20 $\mu\text{g ml}^{-1}$). Be careful not to spill this when weighing out as it is pretty toxic. It is best to make up a 2 mg ml^{-1} stock first (i.e. 0.04 g phenol to 20 ml of distilled water) which can then be stored in the fridge for a long time. To make up 5 mL of each standard solution make the following dilutions into 20 mL vials: <table border="1" data-bbox="470 1456 1396 1769"> <thead> <tr> <th>Final phenol concentration ($\mu\text{g ml}^{-1}$)</th> <th>Amount of distilled water (ml)</th> <th>Amount of 2 mg ml^{-1} phenol stock (μl)</th> </tr> </thead> <tbody> <tr> <td>20</td> <td>4.950</td> <td>50</td> </tr> <tr> <td>15</td> <td>4.963</td> <td>37.5</td> </tr> <tr> <td>10</td> <td>4.975</td> <td>25</td> </tr> <tr> <td>5</td> <td>4.988</td> <td>12.5</td> </tr> <tr> <td>2.5</td> <td>4.993</td> <td>6.25</td> </tr> <tr> <td>0</td> <td>5.000</td> <td>0</td> </tr> </tbody> </table> <p>The standard curve should be linear until the blue colour saturates.</p>	Final phenol concentration ($\mu\text{g ml}^{-1}$)	Amount of distilled water (ml)	Amount of 2 mg ml^{-1} phenol stock (μl)	20	4.950	50	15	4.963	37.5	10	4.975	25	5	4.988	12.5	2.5	4.993	6.25	0	5.000	0
Final phenol concentration ($\mu\text{g ml}^{-1}$)	Amount of distilled water (ml)	Amount of 2 mg ml^{-1} phenol stock (μl)																				
20	4.950	50																				
15	4.963	37.5																				
10	4.975	25																				
5	4.988	12.5																				
2.5	4.993	6.25																				
0	5.000	0																				
References	Swain, T.; Hillis, W.E. 1959. The phenolic constituents of <i>Prunus domestica</i> . I. The quantitative analysis of phenolic constituents. J. Sci. Food Agric. 10: 63-68.																					

ID	31_Kraigher
Author	Kraigher, Hojka Slovenian Forestry Institute, Vecna pot 2, 1000 Ljubljana, Slovenia hojka.kraigher@gozdis.si, +386 1 200 7800
Parameter	Cytokinin analyses in plant tissues, mycorrhizae and fungal cultures
Soil type	Forest soils
Plant species	Spruce
System	Erlenmayer flasks with soil substrates or liquid medium with support for seedlings
Method	HPLC-ELISA – identification and quantification of cytokinins
Method description	<p><i>Background:</i> The methods for sample preparation & extraction were adapted after Turnbull and Hanke (1985). The purification and fractionation step were modified to suit the above mentioned samples. Antibodies raised to bovine serum albumin (BSA) conjugates of the riboside of the Z, iP or DZ in rabbits were used, allowing the identification of the free-base, riboside, ribotide and 9-glucoside cytokinins from the three types. They were characterized by A. Grayling (PhD Thesis, 1990). The enzyme-linked immunosorbent assays were based on Weiler (1984) and performed after Strnad et al. (1992). The initial identification of cytokinins from fungal culture exudates was also confirmed by GC/MS, as described in Kraigher et al. (1991).</p> <p><i>Sample preparation, fungal culture filtrates:</i> Fungal cultures from single flasks (25 or 100 ml medium) were filtered and the fresh weight of mycelium was determined. The volume of each culture filtrate was reduced to ca 4 ml by evaporation under low pressure at 35°C using a rotary evaporator.</p> <p><i>Sample preparation, plant tissues:</i> Seeds of Norway spruce were surface sterilized, soaked overnight in sterile water and planted on i)sterilized or nonsterile sieved soil substrate or ii)on a support filter paper submerged in liquid ½ MN medium. Plant (2-8 weeks old cotyledons) tissue samples, 100 to 800 mg fresh weight, were weighed and immediately crushed in liquid nitrogen. At this point 50 or 100 ml of iPA[³H]-DIOL (10'000 or 20'000 dpm respectively) was added for estimation of recoveries. Tissues were extracted in a ten-fold excess of prechilled 90 % ethanol for 1 to 2 h, on ice, with occasional agitation, or overnight, at 4 to 8 °C. The homogenate was centrifuged at 2300 x g (bench centrifuge) for 15 minutes. The supernatant was reduced by rotary evaporator at 35 °C under low pressure to ca 1 ml.</p> <p><i>Purification:</i> The fungal culture filtrates or tissue extracts were loaded on to C18 Sep-Paks (Waters) primed by passing 4 ml methanol followed by 10 ml 10 mM triethylammonium acetate (TEAA) solution at pH 7.0 through them. After loading the Sep-Paks were washed through with 10 ml 10 mM TEAA and eluted with 50% methanol. The eluate was reduced to less than 1 ml using a rotary evaporator as before. For most exudates and extracts a single polyvinylpyrrolidone (PVP) step was included: 1 g PVP per 1 g fresh weight tissue was used. PVP was primed by 0.01 M acetic acid, pH 3.5, at 1.25 ml per 50 mg PVP in 1.5 ml eppendorf tubes. The acetic acid - PVP was shaken and allowed to stand for 15 mins., the acid was discarded and the procedure repeated three times. The primed PVP was allowed to stand at RT for at most 2 hours. Just before the sample was added, supernatant acetic acid was discarded. The sample - PVP mixture was shaken for 30 mins at RT. The tubes were then centrifuged at 10 000 xg for 25 mins, the supernatant was carefully transferred to a new eppendorf tube and centrifuged for further 2 mins at 10'000 g.</p> <p><i>Fractionation:</i> The equipment (Spectra-Physics) consisted of Solvent degassers SCM400 and Gradient pumps P4000, a dual UV/VIS detectors UV2000 (268 nm), fraction collector SF-2120 and Chromjet integrator CH2 (SP4400 Integrator). Samples were loaded using a Rheodyne 7125 injector fitted with a 1 ml sample loop. C18-bonded silica reverse phase 5 µm ODS columns were obtained from Anachem (Rainin Instruments, USA). The set-up included a pre-column filter, a guard column (4.6 mm i.d., 15 mm long) and an analytical column (4.6 mm i.d., 150 mm long). The moving phases were mixtures of methanol (HPLC grade, BDH or Fisons) and a TEAA</p>

	<p>buffer in double-distilled (deionised) water. Standards of known cytokinins (at about 0.2 nmols each) were run before and after samples to confirm the precise retention times of the various cytokinins. A gradient of buffer (triethylammonium (TEA) Aldrich), pH (adjusted with acetic acid, BDH Analar) and methanol concentration was used (see Kraigher & Hanke 1996). TEA formed the cytokinin-acetate ion-pairing coupling, which changed the hydrophobicity of cytokinins. It allowed iPMP to elute in a clean narrow peak with high reproducibility regarding its retention time and allowed iP and iPA to separate. Flow rate was 1 ml per minute and the fractions were collected each minute for 35 minutes. The fractions were evaporated at low pressure in a centrifugal evaporator (Univap, Uniscience) at 45 °C and resuspended in double-distilled (or deionised) water. Solutions were used for cytokinin-immunoassays either immediately or after storage at -20 °C.</p> <p><i>Quantification:</i> ELISA assays were carried out on the same plates using the competitive method and the IgG fraction was purified from serum by Strnad et al. (1992). Plates were coated with the appropriate IgG antibodies (app. 4 µg/ml) in 50 mM NaHCO₃, pH 9.6, 150 µl per well, overnight at 4 °C. The first two wells of each plate were left uncoated as controls. The plates were washed three times with Tris-buffered saline (TBS: 50 mM Tris-HCl, pH 7.4, 0.15 M NaCl) with Tween 20 (TBS+T), with the plate washer (Titertek M96, Flow Laboratories). The plate washer was programmed to aspirate the original solution in wells, dispense 250 µl of TBS+T, shake for 20 s, then aspirate the TBS+T, in three repetitions. After the third wash, the TBS+T was aspirated and the plate dried under vacuum. Non-specific binding to the plate was blocked by dispensing 200 µl of 0.2 g/l BSA in TBS into each well. The plates were incubated at 4 °C for at least one hour. Then the plates were washed out three times with TBS+T in the plate washer. For competitive binding, first 50 µl of TBS, following by 50 µl of sample or cytokinin-standard, following by 50 µl of cytokinin-alkaline phosphatase conjugate tracer was dispensed into each well. Tracers were diluted 1 in 5000 in 0.2 g/l BSA in TBS. The dilutions of standards used for standard curves ranged from 12 to 6250 fmoles per 50 µl. The plates were incubated for one hour at 4 °C to allow for equilibration and binding. The wells were washed three times (as above) and 150 µl of <i>p</i>-nitrophenyl phosphate (PNPP) in 50 mM NaHCO₃, pH 9.6, were dispensed into each well. The reaction was allowed to continue at RT until the absorbance at 405 nm in the blank wells was about 1. The reaction was stopped by inactivation of the enzyme with 5 M KOH, 50 µl per well. The absorbance of PNP-product was read at 405 nM with the Titertek Multiscan plate reader. HPLC-fractions were analysed in duplicates, each sample for iP-, Z-, and DZ-immunoassay. Standard curves in ELISAs were produced from duplicate samples of the cytokinin riboside, using the four-parameter curve fitting procedure by Delta Soft (BioMetallics Inc., Princeton, NJ). In the representation of results cytokinin-riboside equivalents were used and were not recalculated for cross-reactivities with other cytokinins of each group.</p>
References	<p>Kraigher, H.; Hanke, D.E. 1996. Cytokinins in Norway spruce seedlings and forest soil pollution. <i>Phyton</i> (Horn, Austria) 36: 57-60.</p> <p>Grayling, A.; Hanke, D.E. 1992. Cytokinins in exudates from leaves and roots of red Perilla. <i>Phytochemistry</i>, 31: 1863-1868.</p> <p>Kraigher, H.; Grayling, A.; Wang, T.L.; Hanke, D.E. 1991. Cytokinin production by two ectomycorrhizal fungi in liquid culture. <i>Phytochemistry</i> 30: 2249-2254.</p> <p>Kraigher, H.; Strnad, M.; Hanke, D.E.; Batic, F. 1993. Cytokiningehalte von Fichtennadeln (<i>Picea abies</i> (L.) Karst) nach Inokulation mit zwei Stämmen des Mykorrhizapilzes <i>Thelephora terrestris</i> (Ehrh.) Fr. <i>Forstw. Cbl.</i> 112: 107-111.</p> <p>Strnad, M.; Peters, W.; Beck, E.; Kamínek, M. 1992. Immunodetection and identification of N⁶-(<i>o</i>-hydroxybenzylamino)purine as a naturally occurring cytokinin in <i>Populus x canadensis</i> Moench cv <i>Robusta</i> leaves. <i>Plant Physiol.</i> 99: 74-80.</p> <p>Turnbull, C.G.N.; Hanke, D.E. 1985. The control of bud dormancy in potato tubers. Measurement of the seasonal pattern of changing conc. of zeatin-cytokinins. <i>Planta</i> 165: 366-376.</p> <p>Weiler, E.W. 1984. Immunoassay of plant growth regulators. <i>Ann. Rev. Plant Phys.</i> 35: 85-95.</p>
Links	<p>www.gozdis.si</p>
Additional information	<p><i>Further development of the method is available in:</i></p> <p>Strnad, M. 2000. Protocols for quantification of phytohormones in plants and mycorrhizae. In: Martín, M.P. (Ed.) <i>Methods in root-soil interactions research. Protocols.</i> Slovenian Forestry Institute, Ljubljana, Slovenia, pp. 7 – 18.</p>

ID	31_Kuzyakov_a
Author	Kuzyakov, Yakov Institute of Landscape Matter Dynamics, Leibniz-Centre for Agricultural Landscape Research ZALF, Eberswalder Str.84, D-15374 Müncheberg, Germany kuzyakov@zalf.de; ++49 33432 82326
Parameter	Diffusion of exudates from root surface
Soil type	unimportant, preferably not sandy soil
Plant species	grasses, unimportant
System	Microcosm
Method	¹⁴C pulse labeling, root mat technique, and collection of rhizosphere soil by slicing
Method description	<p>Distribution and diffusion of root exudates can be studied by means of ¹⁴CO₂ pulse labeling of shoots of plants grown in two-compartment pots (Fig. 1) under controlled laboratory conditions. The two-compartment PVC container consisted of (i) an upper part (160 mm height, Ø 57 mm) and (ii) a lower part (40 mm height, Ø 57 mm, Fig. 1). A monofilament screen manufactured by the Büttner GmbH (Sefar Filtration, Rüslikon, Switzerland) separated the two parts from each other. The gauze had 153 threads per cm, the clear mesh is 30 µm, and 21% of the total area is open. Roots did not penetrate through the screen, but root hairs were easily able to grow through the screen into the soil (Kuchenbuch and Jungk, 1982).</p> <p>After ¹⁴C labeling (detailed description by Kuzyakov <i>et al.</i>, 2003), the lower PVC containers were removed and the root-free soil blocks from bottom parts were frozen. Thereafter the soil blocks were inserted in the sample holder of a microtome. The frozen soil blocks were cut into 15 slices about 1 mm thick (other thickness is also possible: >0.1 mm). The dry weight of one slice was about 3.0 g. Shoots, roots and soil were dried at 60 °C. Dry samples of shoots, roots and soil were pulverized in a ball mill prior to the analysis of ¹⁴C radioactivity. Diffusion of root exudates is estimated according to ¹⁴C distribution.</p> <p>For the calculation of the diffusion coefficient of root exudates we used the diffusion equation in the form (Darrah, 1991):</p> $\frac{\partial C_s}{\partial t} = D_e \frac{\partial^2 C_s}{\partial x^2} \quad 0 < x < L \quad \frac{\partial C_s}{\partial t} = 0 \quad x = 0, x = L$ <p>where: C_s: the concentration of diffusing exudates per unit volume of soil at a distance x from the root surface, D_e: the effective diffusion coefficient, L: length of the soil cylinder.</p>
Do's, don'ts, potential limitations, untested possibilities	Using sandy soils can lead to displacement of layers by slicing using the microtome because of large quartz (or other) crystals. The finer the soil texture, the smaller the soil layers can be sliced.
References	Darrah, P.R. 1991. Models of the rhizosphere. I. Microbial population dynamics around a root realising soluble and insoluble carbon. <i>Plant and Soil</i> 133: 187-199.

Kuchenbuch, R.; Jungk, A. 1982. A method for determining concentration profiles at the soil-root interface by thin slicing rhizosphere soil. *Plant and Soil* 68: 391-394.

Kuzyakov, Y.; Raskatov, A.V.; Kaupenjohann, M. 2003. Turnover and distribution of root exudates of *Zea mays*. *Plant and Soil* 254: 317-327.

Additional information (see also colour plate on p. 527)

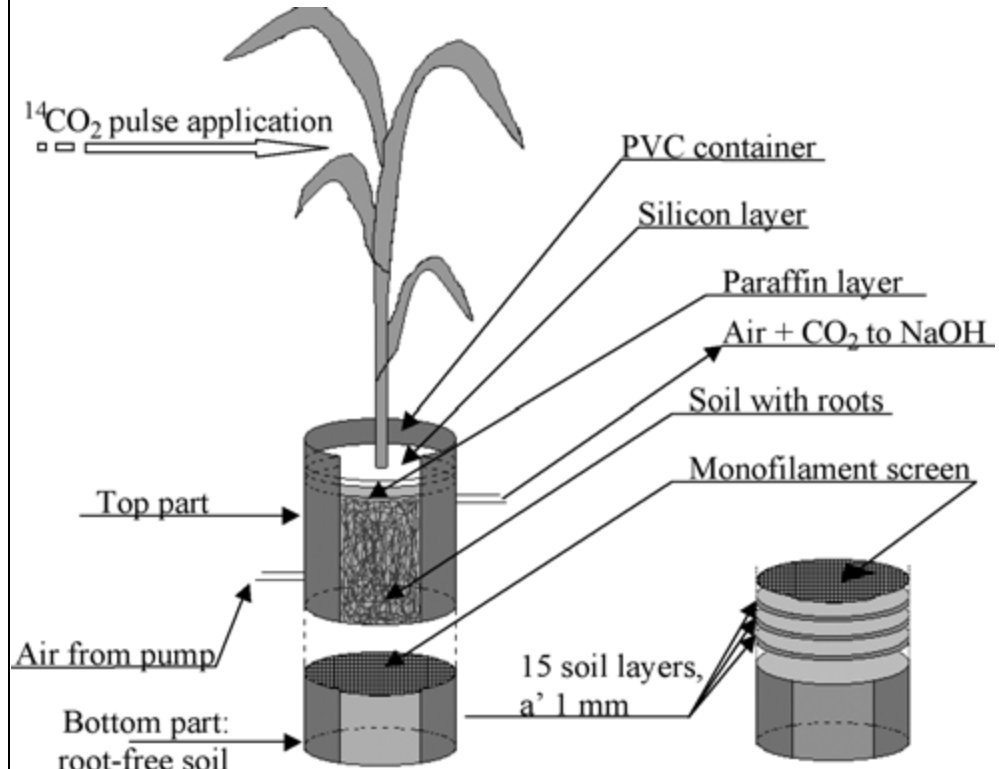
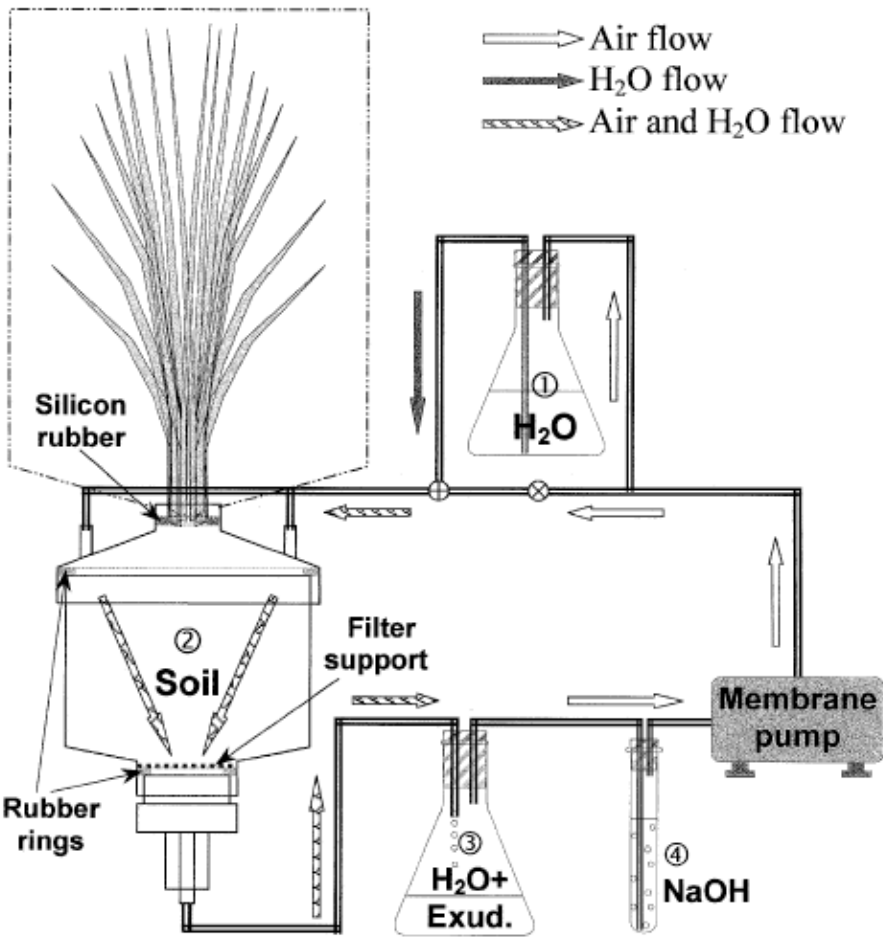



Fig. 1: Two-compartment pot for studying distribution of root-derived carbon as a function of root proximity and estimation of exudate diffusion (from Kuzyakov et al., 2003; with kind permission of Springer Science and Business Media).

ID	31_Kuzyakov_b
Author	Kuzyakov, Yakov Institute of Landscape Matter Dynamics, Leibniz-Centre for Agricultural Landscape Research ZALF, Eberswalder Str.84, D-15374 Müncheberg, Germany kuzyakov@zalf.de; ++49 33432 82326
Parameter	Simultaneous collection of root exudates and measurement of root respiration
Soil type	preferably sandy
Plant species	grasses
System	Microcosm
Method	¹⁴C pulse labeling; elution of root exudates for composition analysis with simultaneous CO₂ trapping
Method description	<p>The experimental setup for exudate elution consists of a two-compartment chamber, two flasks, one test tube with NaOH aqueous solution, and a membrane pump connected to other parts by PVC tubes (Fig. 1). The upper part of the chamber (dashed line in Fig. 1) is covered only for a short period to allow pulse ¹⁴C-labeling of shoots. In the bottom part of the chamber ② a Polycarbonate filtration device CombiSart with total volume of 340 mL was fitted (Merck®). The bottom chamber contained soil with roots. Prior to labeling, the soil surface under the hole of the lid was sealed with a 2 mm layer of silicone paste. PVC tubes brought air and deionized water through the three inlets into the CombiSart device from the output of the membrane pump and flask ①, respectively. The bottom outlet was connected with PVC tube to the flask ③ and test tube ④ with NaOH in series. Water with released exudates and air with ¹⁴CO₂ coming from root respiration come through the outlet, which then dropped into another flask ③ and was separated from ¹⁴CO₂ adsorbed in NaOH in the test tube ④. Micropur® containing Ag⁺ was added to the flask ③ to suppress the microbial decomposition of leaked exudates before analysis. The test tube ④ was connected to the input of the pump, this way air circulation was closed in the whole system. The traps for ¹⁴CO₂ evolving from root respiration and those for eluted exudates were started at the beginning of labeling. Flask ① was filled up regularly with water and flask ③ emptied. At the same time the NaOH solution in the test tube ④ was exchanged. 400 ml of distilled water was used to fill up flask ① and 20 ml of 0.25 M NaOH was used to fill up test tube ④. At the start of elution a short closing (10-20 seconds) of the tube at the clamp ⊗ was necessary to increase the pressure in the flask ① and to start the movement of water into the tube behind the flask ①.</p> <p>When the water level in the tube was lower than the water level in flask ①, then the Siphon principle began to work. The clamp ⊗ could then be opened and the water continues to move according to the Siphon principle. At the joint ⊕, the water from the flask mixes with the air coming from the pump. Between the joint ⊕ and flask ③ the movement of water with air as bubbles in the tube occurs simultaneously (dashed arrows). Behind the flask ③ only air is pumped (blank arrows).</p> <p>Fresh air was introduced into each container once daily to compensate for the O₂ consumed by soil microorganisms and roots.</p>

Do's, don'ts, potential limitations, untested possibilities	<ul style="list-style-type: none"> • The method works well for sandy soils and bad for clay soils. • Control without plants is necessary for evaluation of organic substances eluted from unplanted soil. • The method can be coupled with exudate identification by Py-FIMS or HPLC. • Labeling is suitable for calculation of balance of assimilated C.
References	<p>Kuzyakov, Y.; Siniakina, S.V. 2001. Siphon method of separating root-derived organic compounds from root respiration in non-sterile soil. <i>Journal of Plant Nutrition and Soil Science</i> 164: 511-517.</p> <p>Kuzyakov, Y.; Leinweber P.; Saprnov D.; Eckhardt K.-U. 2003. Qualitative assessment of root exudates in non-sterilized soil by analytical pyrolysis. <i>Journal of Plant Nutrition and Soil Science</i> 166: 719-723.</p> <p>Melnitchouck, A.; Leinweber, P.; Eckhardt, K.-U.; Beese, R. 2005. Qualitative differences between day- and night-time rhizodeposition in maize (<i>Zea mays</i> L.) as investigated by pyrolysis-field ionization mass spectrometry. <i>Soil Biology & Biochemistry</i> 37: 155-162</p>
Additional information	<p>Figure 1. Experimental setup for the separate measurement of root respiration and exudation. ① - flask with water for elution, ② - Polycarbonate filtration device CombiSart with soil and roots, ③ - collection flask with eluted exudates, ④ - test tube with NaOH solution for CO₂ trapping. ⊗ - regulation clamp, ⊕ - joint where air and water flows are connected.</p> 

ID	31_Morel
Author	Morel, Jean Louis ; Benizri, Emile ; Guckert, Armand INP de Lorraine, 2 Av. de la Forêt de Haye, 54 505 Vandoeuvre-lès-Nancy, France Jean-Louis.Morel@ensaia.inpl-nancy.fr ; ++33 3 83585847 Emile.Benizri@ensaia.inpl-nancy.fr ; ++33 3 83595848 Armand.Guckert@ensaia.inpl-nancy.fr ; ++33 3 83585835
Parameter	Mucilages and soluble high-molecular weight exudates
Plant species	Maize
System	Axenic and non axenic microcosm
Method	Collection and characterization of macromolecular rhizodeposits
Method description	<p><i>Mucilages:</i> Root mucilages are obtained from maize plants (<i>Zea mays</i> L.) grown under non-sterile and sterile conditions.</p> <p><i>Non sterile conditions:</i> Mucilages are collected from nodal roots of maize plants, grown in the field. Under a high hygrometric level, nodal roots are embedded in a large mucilage coating (Fig. 1). During the first stage of development, the nodal roots are aerial and thus not contaminated with soil particles. Maize plants are cut above the soil surface just before flowering. Aerial parts and lower roots are discarded. The basis of the stalk is then immersed in distilled water overnight. Afterwards, the swelled mucilage layer is collected by suction. It is possible to collect typically around 2 mL of slime per plant. Two harvests made on the same plant produced about 6 to 8 mg dry matter of mucilage.</p> <div style="display: flex; justify-content: space-around;">   </div> <p>Fig. 1: Nodal roots covered with mucilage Fig. 2 : Collection of mucilage (see also colour plates on p. 527)</p> <p><i>Axenic conditions:</i> Sterile hydroponic cultures are used in order to obtain intact mucilages. Maize seeds are surface sterilized by soaking them for 30 s in 95% H₂SO₄, 5 min in 95% ethanol, 30 min in 10% H₂O₂, and rinsed thoroughly in sterile distilled water. They are aseptically introduced into autoclaved glass tubes (Fig. 2; L = 38 cm ; diameter = 4 cm) containing a polyethylene support and 165 ml of sterile mineral solution. The tubes are closed at their base by a rubber stopper to allow aeration of the medium and the renewal of the nutrient solution. The tubes are closed by sterile cotton. Seeds are germinated for 3 days at 26°C with a relative humidity of 80% in the dark.</p> <p>Plants are grown in a growth chamber: (PPFD: 350 μmol.m⁻².s⁻¹), rel. humidity of 65%, 16 h photoperiod, 19 °C night and 22 °C day.</p> <p>After 5 days, the plant leaves reached the top of the tubes. Roots and shoots are separated with sterile cotton, allowing shoot development with minimal</p>

constraint. Contaminated tubes are discarded. Collection of mucilage is performed by vacuum suction.

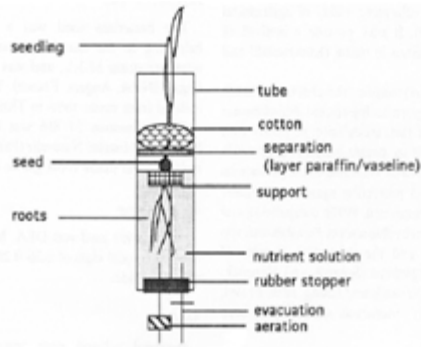

Fig. 2. Device for production of sterile mucilage and soluble exudates (reprinted from Benizri et al., 1995; with permission from Elsevier)

Preparation and analysis of mucilages:

The crude mucilage is pooled and centrifuged at 10'000 r.p.m. to remove root debris. The supernatant is then dialysed 3 times against deionised water (Visking Tubing 12 000 to 14 000 MW membrane) and stored at -20°C . For sterile mucilages, purification is conducted in presence of a cation-exchange resin in the H^+ form. The material is then freeze-dried and stored under vacuum. It is analysed quantitatively for C, N, polysaccharides, uronic acids, etc.

High molecular weight soluble exudates:

Plants are grown under aseptic conditions, as described above. The soluble root exudates are collected from the solution by filtration under nitrogen (porosity $0.45\ \mu\text{M}$). The filtrate is concentrated by evaporation ($+30^{\circ}\text{C}$) under vacuum, then dialysed 4 times against bi-distilled water at $+4^{\circ}\text{C}$ under a nitrogen atmosphere (Spectra/por 6MW 100 membranes). The non-dialysable compounds, i.e. the high molecular weight soluble root exudates are freeze-dried and stored under vacuum. A modification of this device allows to collect the exudates in a flow system: the glass tubes are filled with autoclaved sand and the seeds are watered with sterile Hoagland's solution medium *via* a peristaltic pump for 15 days which is timed to run continually and deliver 41,5 ml over 24h. The collection and conditioning of the exudates is the same as above. The exudates are analysed for total C and N, ash content, total reducing sugars, total proteins, uronic acids, total phenolic compounds.

Do's, don'ts, potential limitations, untested possibilities

- Axenic collection requires a check for sterility, the quantities of mucilages collected under these conditions are limited, in comparison with the non axenic device.
- The mineral load (medium) of the soluble exudates can be a problem in some cases.

References

Morel, J.L.; Mench, M.; Guckert, A. 1986. Measurement of Pb^{2+} , Cu^{2+} and Cd^{2+} binding with mucilage exudates from maize (*Zea mays* L.) roots. Biol. Fertil. Soils 2: 29-34.

Mench, M.; Morel, J.L.; Guckert, A. 1987. Metal binding of high molecular weight soluble exudates from maize (*Zea mays* L.) roots. Biol. Fertil. Soils 3: 165-169.

Benizri, E.; Courtade, A.; Guckert, A. 1995. Fate of two microorganisms in maize simulated rhizosphere under hydroponic and sterile conditions. Soil Biol. Biochem 27: 71-77.

ID	31_Neumann_a
Author	Neumann, Günter Institute of Plant Nutrition (330), Hohenheim University, D-70593 Stuttgart, Germany; gd.neumann@t-online.de; ++49 711 459 4273
Parameter	Collection of Root exudates
Plant species	All species
System	Hydroponics
Method	Localized collection of root exudates by use of sorption media from plants grown in hydroponics
Method description	<p>Filter paper with a high soaking capacity (e.g. Whatman 3 MM; Scheicher & Schuell 2992), cellulose-acetate-, cellulose-nitrate- or blotting-membranes, applied onto the root surface for collection of root exudates from different root zones.</p> <p><i>Application:</i> Cut collection media into strips or discs of adequate size. Wash with methanol and dist. water to remove impurities. Take plants out of the culture vessels and wash root systems for 1 min with dist. water. Spread roots on a flat plastic tray. Carefully isolate single roots for sampling by use of forceps. Cover the rest of the root system with filter paper, soaked with nutrient solution to avoid drying. Apply filter discs or strips, soaked in water onto the root zones of interest (Fig.1).</p> <p><i>Selection of sorption media, collection time and re-extraction:</i> <i>Filter paper:</i> Low molecular weight compounds. Short-term collection 1-3 h to minimize microbial degradation. Re-extraction with water or buffers for subsequent analysis. (e.g. quantitative extraction of organic acids with 150 μL $\text{H}_2\text{O cm}^{-2}$ for Schleicher & Schuell 2992 paper, by vigorous shaking and subsequent centrifugation. Supernatant for HPLC injection or enzymatic analysis). <i>Cellulose acetate filters:</i> phenolic compounds (also possible with filter paper). Collection period 6-20 h, re-extraction with methanol (Fig.3). <i>Blotting membranes:</i> for root-secretory enzymes (also possible with filter paper) simultaneous or subsequent detection of enzyme activity by indicator reactions (Fig.4).</p>
Do's, don'ts, potential limitations, untested possibilities	<ul style="list-style-type: none"> • Careful handling of roots, avoid pressure or squeezing. • Calculation of exudation rates refers to root length (non-destructive) or biomass (destructive) of the selected root zones; water uptake capacity of the filters and dilution during extraction must be taken into account. • Occasional remoistening of filters during the collection period. • Potential limitation for very fine roots due to low amounts of exudates.
References	<p>Grierson, P.F.; Comerford, N.B. 2000. Non-destructive measurement of acid phosphatase activity in the rhizosphere using nitrocellulose membranes and image analysis Plant Soil 218:49-57.</p> <p>Neumann, G.; Römheld, V. 1999. Root excretion of carboxylic acids and protons in phosphorus-deficient plants. Plant Soil 211: 121-130</p>

Additional information (colour plates p. 528):

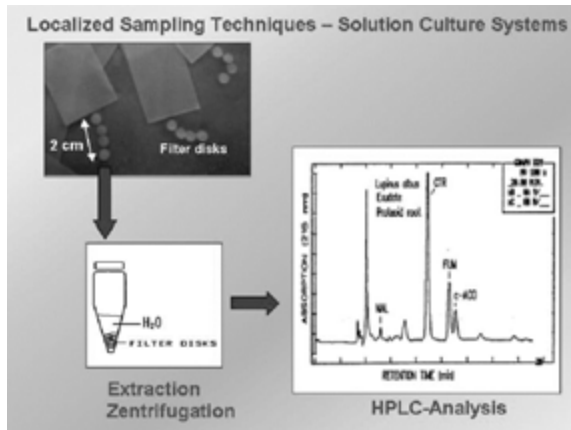

Fig. 1: Localized collection of root exudates from plants grown in hydroponics by application of filter paper with subsequent extraction and HPLC analysis

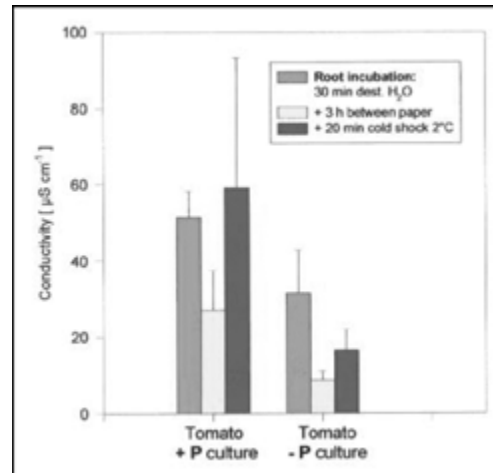

Fig. 2: Root injury was evaluated by measuring electrical conductivity of root washings before and after covering the root systems with filter paper. The conductivity was not increased by paper application, indicating that there was no mechanical damage of the roots. In contrast, cold-shock treatments (20 min 2°C) increased the conductivity by approximately 100 %, proving the sensitivity of the conductivity test.

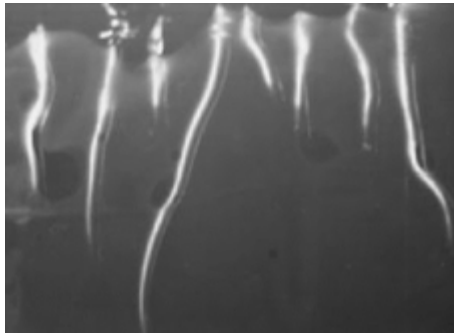
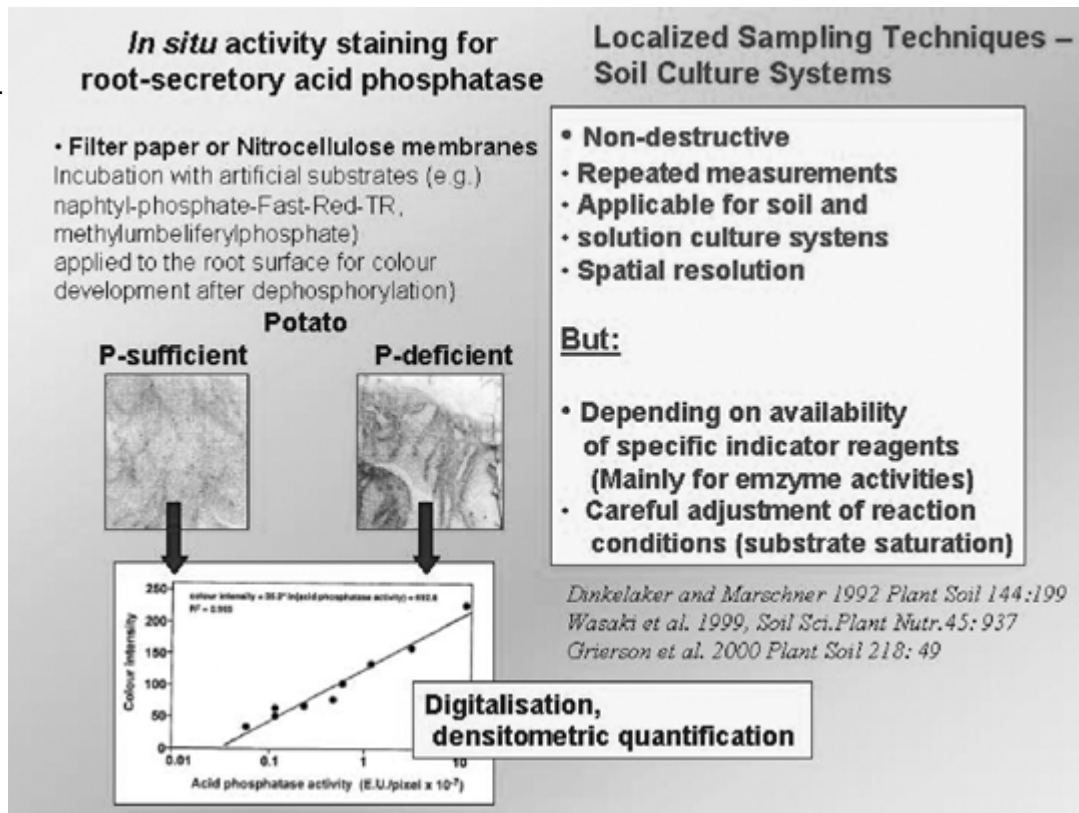

Fig.3: Fluorescent phenolics released along the main root of cowpea seedlings. Collection by application of a nylon membrane onto the root surface.

Fig.4



ID	31_Neumann_b
Author	Neumann, Günter Institute of Plant Nutrition (330), Hohenheim University, D-70593 Stuttgart, Germany gd.neumann@t-online.de; ++49 711 459 4273
Parameter	Collection of root exudates and rhizosphere soil solution from soil-grown plants
Soil type	All soils
Plant species	All species
System	Rhizoboxes, field studies with root windows
Method	Localized collection by use of sorption media
Method description	<p>Filter paper with a high soaking capacity (e.g. Whatman 3 MM; Scheicher & Schuell 2992), celluloseacetate-, cellulose-nitrate- or blotting-membranes, applied onto the root surface for collection of rhizosphere soil solution.</p> <p><i>Application:</i> Cut collection media into strips or discs of adequate size. Wash with methanol and distilled water to remove impurities. Apply filter discs or strips, soaked in water onto the root zones of interest (Fig.1). Also applicable for collection of soil solution and subsequent mineral analysis (Fig.5). In presence of high soil moisture levels (e.g. 90% of water holding capacity; in sandy soils 50-90% WHC) the equilibrium solute concentration between soil solution and soaking water in the filter paper reflects approx. 50% of the original solute concentration in the soil solution (tested with nitrate).</p> <p><i>Selection of sorption media, collection time and re-extraction:</i> <i>Filter paper:</i> for organic acids, sugars, amino acids. Short-term collection 1-2 h to minimize microbial degradation. Re-extraction with water or with HPLC elution buffers for subsequent analysis. (e.g. quantitative re-extraction of organic acids with 150 µL H₂O cm⁻² for Schleicher & Schuell 2992 paper, by vigorous shaking and subsequent centrifugation. Supernatant for direct HPLC injection or enzymatic analysis. <i>Cellulose acetate filters:</i> phenolic compounds (also possible with filter paper). Collection period 6-20 h, re-extraction with methanol (Fig.4) <i>Blotting membranes:</i> for root-secretory enzymes (also possible with filter paper) simultaneous or subsequent detection of enzyme activity by indicator reactions (Fig.3)</p>
Do's, don'ts, potential limitations, untested possibilities	<ul style="list-style-type: none"> • Calculation of exudation refers to root length (non-destructive) or biomass (destructive) of the selected root zones; Water-uptake capacity of the filters and dilution during extraction must be taken into account. • Occasional re-moistening of filters during the collection period, particularly important at lower soil moisture levels. • Potential limitation for very fine roots due to low amounts of exudates. • It should also be kept in mind that only compounds dissolved in the rhizosphere solution are caught by the filter paper technique, but considerable amounts of root derived organic compounds can be rapidly adsorbed to the soil matrix. Recovery experiments to evaluate sorption effects.

References Dinkelaker, B.; Hengeler, C.; Neumann, G.; Eltrop, L.; Marschner, H. 1997. Root exudates and mobilization of nutrients. In: Rennenberg, H.; Eschrich, W.; Ziegler, H. (eds), *Trees, Contributions to modern Tree Physiol.* Backhuys, Leiden, NL, pp. 441-452.

Additional information (see also colour plates on p. 529):

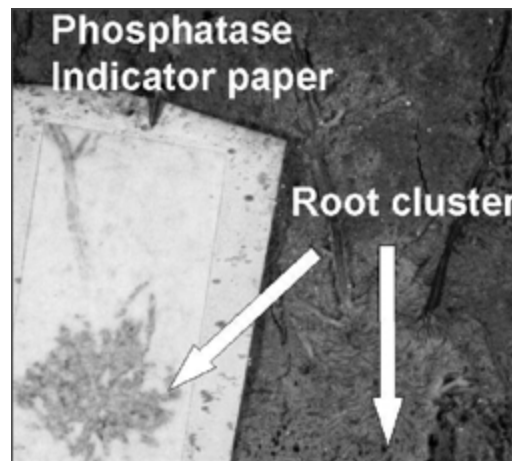
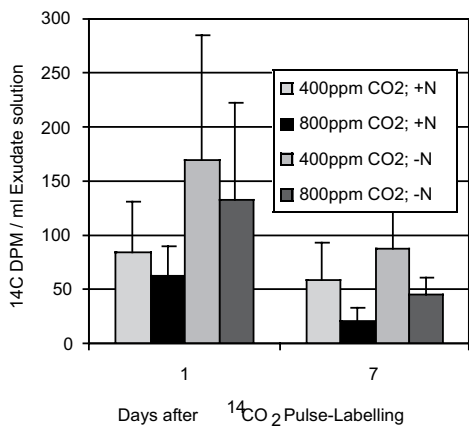
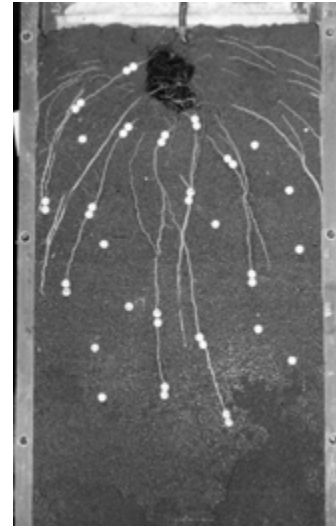
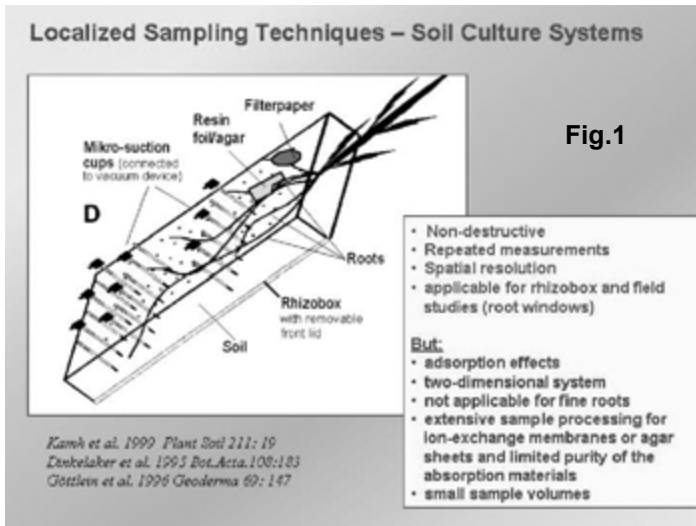

Fig. 2: Localized collection of ¹⁴C-labeled root exudates collected with paper discs (∅ 5 mm, see Fig.1) in 1 cm apical root zones after ¹⁴CO₂ shoot pulse-labelling of bean plants grown in rhizobox culture depending on N supply and atmospheric CO₂ concentration.

Fig.3: Detection of acid phosphatase activity with phosphatase indicator paper at the root surface of cluster roots of *Hakea undulata* in rhizobox culture.

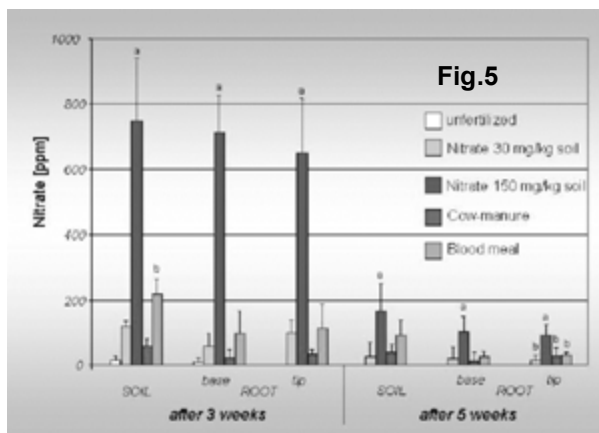

Fig.4: Fluorescent phenolics released from bean roots in rhizobox culture. Collection by 20-application of a nylon membrane onto the root surface.

Fig.5: Nitrate in soil solutions collected with paper discs (∅ 5 mm, see Fig.1) in a rhizobox culture system with apple seedlings supplied with different forms of N fertilization.

ID	31_Neumann_c
Author	Neumann, Günter Institute of Plant Nutrition (330), Hohenheim University, D-70593 Stuttgart, Germany gd.neumann@t-online.de; ++49 711 459 4273
Parameter	Organic acids in root exudates and plant extracts
Plant species	All species
System	All systems
Method	Reversed Phase HPLC with suppressed Ionization
Method description	<p><i>Principle:</i> Dissociation of organic acids is suppressed by low pH levels of the eluent (pH 2-3). The protonated acids are separated by hydrophobic interactions with the apolar stationary phase of the RP-column.</p> <p><i>Column:</i> Standard RP-18 columns may be used for separation. RP-phases without endcapping or with hydrophilic endcapping. Testing different columns, we have obtained good results with a 250 x 4 mm Merck Lichrospher-100 5μ RP-18 column (+ guard column) or a GROM GS ODS-3 120 CP, 5μ. The latter column contains a polymer coated RP-18 phase which may be more resistant to the low pH of the elution buffer. Injection volume: 20 μl.</p> <p><i>Eluent:</i> Isocratic elution with 18 mM KH₂PO₄ adjusted to pH 2.1 - 2.5 with o-phosphoric acid, flow-rate 1.0-0.5 ml / min, 20-50°C. Retention times are modified by altering the pH of the eluent. Altering column temperature and eluent flow rate are other possibilities to modify retention times and resolution.</p> <p><i>Detection:</i> UV 210-225 nm. Selectivity: Baseline separation during 20 min for at least 12 common mono-, di-, and tricarboxylic acids. Linearity: 0.5 - 50 ppm. Sensitivities for fumaric, maleic, aconitic and shikimic acids are approximately 100 times higher. Changing the detection wavelength from 220 nm to 210 nm increases the sensitivity by 30%, but baseline noise is also increased. If the sample volume is not a limiting factor, the sensitivity may be further increased by increasing the injection volume up to 100 μl.</p>
Do's, don'ts, potential limitations, untested possibilities	<ul style="list-style-type: none"> • Eluent pH values lower than 2.0 are not recommended to avoid hydrolytic damage of the column. • Daily washings of the column (2 x 30 mL) with methanol to remove less polar compounds. • If selectivity declines: regeneration with methanol/chloroform (1:1). • Detector sensitivity range settings: 0.001-0.005 AU.
References	<p><i>For description of HPLC systems see:</i> Neumann, G.; Römheld, V. 1999. Plant Soil 211: 121-130. Keefer, J.F.; Schuster, S.M. 1986. J. Chrom. 383: 297-305.</p>
Additional information	<p><i>Sample pre-treatment:</i> <i>Tissue samples:</i> Extraction and deproteinization with 5% H₃PO₄ (1 ml/100 mg fresh weight), cell debris removed by centrifugation. In many cases, direct HPLC injection without further purification is possible after 10-fold dilution with HPLC elution buffer (18 mM KH₂PO₄, pH 2.1 with H₃PO₄).</p>

Root exudate samples: (see 31_Neumann_a and 31_Neumann_b) can be frequently used after centrifugation for direct HPLC injection. For further purification, pre-treatment with a strongly acidic cation-exchange resin is sufficient in most cases in order to remove cationic constituents (e.g. amino acids). Also many phenolic compounds are removed due to interactions with the hydrophobic matrix of the resin (e.g. Merck Lichrolut SCX: resin washed several times with methanol and dist. water by centrifugation). Vigorously mix resin and sample at a ratio of 100 mg dry resin/1 ml, remove the resin by centrifugation and use the supernatant for analysis.

Interfering substances:

The detection of early eluting acids (especially oxalic acid) can be affected by other early eluting compounds such as nitrate and amino acids. Many amino acids will be removed by sample pre-treatment with a cation exchanger. Nitrate interferences can be reduced by acidification of the sample (pH 1.0) with H₃PO₄ or H₂SO₄, and subsequent addition of an anion exchange resin. Inorganic anions are bound by the anion exchanger and can be removed by centrifugation, whereas the protonated organic acids are remaining in the supernatant (recovery experiments!). Sugars are undetectable at 210-220 nm. Many aromatic compounds have retention times > 20 min and will be also removed during sample pre-treatment. However, very polar aromatic compounds (e.g. highly glycosylated phenolics) may cause some interference. Due to UV-absorption at 260 nm, these compounds can be easily distinguished from aliphatic organic acids.

Comparison with other methods:

Good agreement of the results obtained from malic and citric acid determinations by standard enzymatic methods (see data sheet by Delhaize and Ryan) with the results of the present HPLC method. Enzymatic methods also recommended for confirmation of identity. HPLC-separation by ion-exclusion chromatography with a BioRad Aminex HPX 87-H organic acid-column (eluent 2.5 mM H₂SO₄) revealed lower selectivity and also lower sensitivity due to the larger column dimensions. - Reversed phase HPLC on C-18 columns, with tetrabutylammonium hydroxide added to the eluent as a reagent for ion pairing with organic acids, in order to increase their hydrophobicity (Keefer and Schuster, 1986), may serve as an alternative method to the separation of organic acids in the "ion-suppression mode", with similar levels of selectivity.

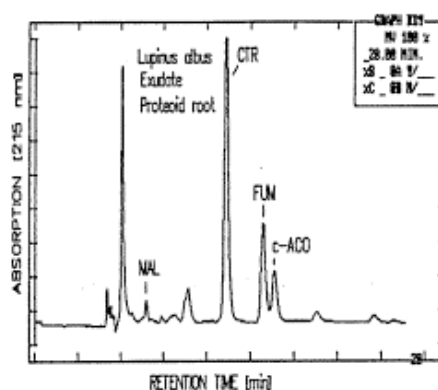

Fig. 1. Typical RP- HPLC separation in the ion suppression mode of a root exudate sample, collected from cluster roots of *Lupinus albus*. MAL = malic-, CTR = citric-, FUM = fumaric, c-ACO = cis-aconitic-acid.

ID	31_Neumann_d
Author	Neumann, Günter Institute of Plant Nutrition (330), Hohenheim University, D-70593 Stuttgart, Germany; gd.neumann@t-online.de; ++49 711 459 4273
Parameter	Phytosiderophores in root exudates and plant extracts
Plant species	Graminaceous plants
System	Hydroponics; (soil culture)
Method	Anion-exchange HPLC
Method description	<p><i>Principle:</i> Mugineic acid and its analogues (MAs) are highly effective iron chelators (phytosiderophores, PS), released from roots of graminaceous plant species in response to iron deficiency. MAs are tricarboxylic amino acids with various hydroxylation patterns (Fig. 1). Due to the anionic nature of hydroxy-functions at pH 10-13, the retention of different MAs on anion exchange columns will increase when hydroxylation increases.</p> <p><i>Column:</i> Dionex AS11 column (250 x 4 mm I.D.) equipped with a Dionex AG11 guard column (50 x 4 mm I.D.)</p> <p><i>Eluent:</i> Low-pressure binary gradient elution with deionized water (solvent A) and 125 mM NaOH (= solvent B). Gradient profile: Separation: 0 - 8 min, 10% solvent B in A ;8 - 18 min, 10% - 20% B in A; Column clean-up:18 - 20 min, 20% - 40% B in A ;20 - 21 min, 40% B in A; Re-equilibration: 21 - 24 min, 40% - 10% B in A; 24 - 30 min, 10% B in A. Column temperature: 32°C; Injection-volume: 20µL.</p> <p><i>Detection:</i> Fluorescence detection after post-column derivatization with OPA (Orthophthaldialdehyde), as well as pulsed amperometric detection (PAD) was possible with the same separation system. Detection limits: 2.5 µM with a linear range between 5-125 µM (peak height) and 20-350 µM (peak area) for fluorescence detection and for PAD detection: 1-100 µM.</p>
Do's, don'ts, potential limitations, untested possibilities	<ul style="list-style-type: none"> • For stable retention times, avoid trapping of carbonate into the eluents (careful degassing, no stirring, closed bottles), • Periodic column regeneration: 100 mM oxalic acid (1-2 h, 1mL/min) • PS-analysis may be also possible with conventional Ion chromatography systems using the same separation system coupled with conductivity detection.
References	<p>Neumann, G.; Haake, C.; Römheld, V. 1999. Improved HPLC-method for determination of phytosiderophores in root washings and tissue extracts. J. Plant Nutr. 22:1389-1402.</p> <p>Weber, G.; Neumann, G.; Haake, C.; Römheld, V. 2001. Determination of phytosiderophores by anion-exchange chromatography with pulsed amperometric detection J. Chromatogr. 928A: 171-175.</p>
Additional information	<p><i>Sample pre-treatment:</i> <i>Tissue samples:</i> Plant tissue, finely ground with liquid N₂ is extracted twice with boiling H₂O (500 µL/g FW). After 10 min incubation at 80°C, cell debris is removed by centrifugation and the supernatant is ready for HPLC injection.</p>

Root exudate samples: are collected as root washings of plants cultivated for 2-3 weeks without iron-supply. Particularly high rates of PS exudation are observed in barley, wheat or rye. Root washings collected from three plants over 2-3 h into 30 mL of water can be analysed directly without further sample.

Eluents:

A stock solution of 50% (w/w) NaOH is prepared weekly (Stock solution A). Avoid excessive stirring to minimize trapping of CO₂. Every day, 10 g of the stock solution is diluted to 1000 g with H₂O to obtain a NaOH concentration of 125 mM, representing solvent B for gradient elution. Solvent A is demineralized H₂O. Solvents are degassed with Helium.

OPA-post-column derivatization:

Sodium hypochlorite solution for MA oxidation is prepared daily from a stock solution of 123.5 g boric acid and 65 g KOH dissolved in 1000 mL H₂O stored in the fridge (stock solution B). 200 ml of the stock solution are mixed with 100 µL of a 12% sodium hypochlorite solution and H₂O to a final volume of 1000 mL. Prepare a stock solution of orthophtaldialdehyde (OPA) containing 24.7 g boric acid, 23 g KOH, 2.0 g N-acetylcysteine, and 1.6 g OPA in a final volume of 1000 mL H₂O (= stock solution C). 100 mL aliquots of the stock solution C are stored at -18 C and discarded when the colour turned to slightly yellow. The OPA-reagent for fluorescence labelling of oxidized MAs is prepared daily by mixing 180 mL of stock solution B (see above) with 100 mL stock solution C and H₂O to a final volume of 1000 mL. All reagents used for derivatization are stored in dark bottles. Derivatization reagents are mixed with the eluent stream at a flow rate of 0.8 mL/min in a reaction oven adjusted to 50°C. In a first reaction coil (teflon capillary, 800 x 0.25 mm I.D.), MAs are oxidized with the sodium hypochlorite solution in order to enable the reaction with OPA which is performed in the second reaction coil (Peek capillary, 1900 x 0.25 mm I.D) with subsequent fluorometric detection (λ excitation: 330 nm, λ emission: 440 nm).

Pulsed amperometric detection (PAD):

0.5 M NaOH is added to the eluent stream at a flow rate of 0.3 mL/min to adjust the pH to 13. PAD is performed with a gold electrode. Detection settings at +0.1 V (t=300 ms, 200 ms acquisition delay), oxidative cleaning at + 0.6 V (t= 120 ms) and regeneration at -0.8V (t= 300 ms).

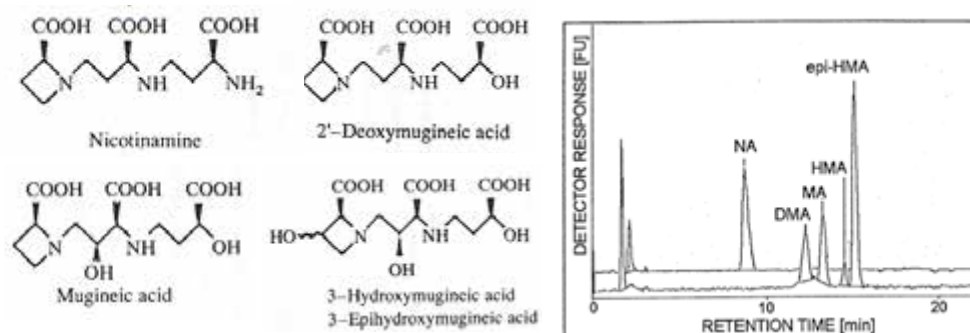

Fig. 1: Structure and anion-exchange separation of common phytosiderophores and the precursor nicotianamine with post-column OPA-fluorescence labelling. Nicotianamine = NA; Deoxymugineic acid = DMA; Mugineic acid = MA; Hydroxymugineic acid = HMA; epi-Hydroxymugineic acid = epi-HMA. (from Neumann et al., 1999; with permission of Taylor & Francis)

ID	31_Neumann_e
Author	Neumann, Günter Institute of Plant Nutrition (330), Hohenheim University, D-70593 Stuttgart, Germany gd.neumann@t-online.de; ++49 711 459 4273
Parameter	<i>In situ</i> detection of root-induced Al complexation
Soil type	All soils
Plant species	All species
System	Hydroponics, Soil culture in rhizoboxes
Method	Application of gels containing Al chelator
Method description	<p>The presence of Al-complexing chelators in root exudates and rhizosphere soil solution can be visualized by application of agar gels, containing red-coloured Al-aluminon complexes onto the root surface. The presence of Al chelators with a higher affinity to Al, compared with aluminon (e.g. organic acid anions, phenolics) is indicated by decolouration zones (Fig.1).</p> <p><i>Application:</i> Gels of polyacrylamide (1 mm ,10% T), agar (3 mm, 1.0% w/v) or agarose (3 mm, 1.0% w/v) can be used as carrier matrix for the Al-aluminon complex. Aluminon Stock solution: 24g NaOH, 175 mg Aluminon (Merck) dissolved in 120 mL acetic acid and adjusted to 500 mL with dist. H₂O (pH = 4.2). Mix 25 mL of aluminon with 70 mL agar solution containing 250 µM Al(NO₃)₃ and 5 mL 0.5% ascorbic acid when the boiled agar solution has reached a temperature of 50°C. Pour the solidifying agar solution into flat perspex cuvettes to obtain gel sheets with 3 mm thickness. Place agar sheets onto the root surface of plants grown in rhizoboxes or hydroponic culture. Depending on the amount of Al-complexing compounds released from the root or accumulated in the rhizosphere, decolouration is visible after 2 –16 h. Cover agar sheets with plastic foil to avoid evaporation.</p>
Do's, don'ts, potential limitations, untested possibilities	For some plant species, the acetate buffer used for the aluminon stock solution may cause toxic effects (e.g. rapid wilting in potato). In these cases alternative buffer systems in the respective pH range may be tested.
References	<p>Dinkelaker, B.; Hahn, G.; Römheld, V.; Wolf, G.A.; Marschner, H. 1993. Non-destructive methods for demonstrating chemical changes in the rhizosphere I. Description of methods 1993 Plant Soil 155/156: 67-70</p> <p>Kerven, G.L.; Edwards, D.G.; Asher, C.J.; Hallman, P.S.; Kokot, S. 1989. Aluminum determination in soil solution. 1. Evaluation of existing colorimetric and separation methods for the determination of inorganic monomeric aluminum in the presence of organic acid ligands. Aust J. Soil Res. 27: 79-90.</p> <p>Kerven, G.L.; Edwards, D.G.; Asher, C.J.; Hallman, P.S.; Kokot, S. 1989. Aluminum determination in soil solution. 2. Short-term colorimetric procedures for the measurement of inorganic monomeric aluminum in the presence of organic acid ligands. Aust J. Soil Res. 27: 91-102.</p>

Additional information (see also colour plates on p. 530):

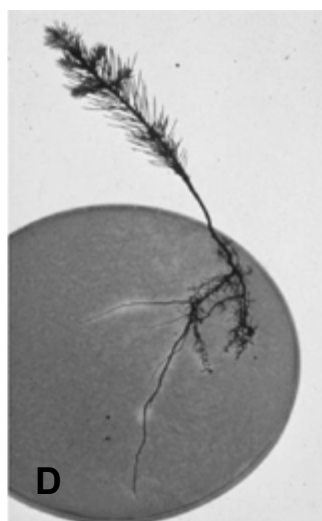
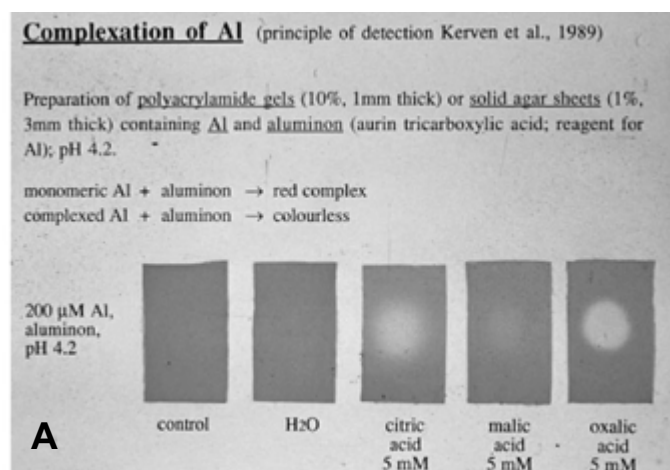

Fig. 1: Principle (A) and applications for *in situ* detection of Al complexation with the aluminon competition test: (B) Al-complexation along roots of Norway spruce in rhizobox culture. (C) Root-induced Al-complexation in seedlings of *Lupinus luteus* and (D) Norway spruce, grown in hydroponic culture.

Quantification of Al-complexation in root exudates:

A modification of the method can be used to quantify the Al-complexing capacity of root exudates and rhizosphere soil solution. Root exudates samples (3 volumes) or water (control) are mixed with aluminon stock solution (1 volume), containing 1 mM Al(NO₃)₃ and 6 μM ascorbic acid and decolouration is measured spectrophotometrically at 530 nm after a reaction time of 5 min (see: Table 1)

Table 1: Aluminium complexation in different fractions of root exudates of sunflower seedlings incubated for 20 h in 0.5 mM CaSO₄ pH 4.5 with or without application of 50 μM AlCl₃. One aliquot of the exudate samples was pre-purified over a Sep-Pak C-18 cartridge to remove phenolic compounds.

Sample	Decline in Absorption [530 nm] -Al treatment	Decline in Absorption [530 nm] + Al treatment	Absorption difference: +Al / -Al
Whole root exudate	0.09± 0.03	0.14±0.00	0.050
Root exudate without phenolic fraction	0.02	0.08	0.060

ID	31_Neumann_f
Author	Neumann, Günter Institute of Plant Nutrition (330), Hohenheim University, D-70593 Stuttgart, Germany gd.neumann@t-online.de; ++49 711 459 4273
Parameter	<i>In situ</i> detection of root-induced Mn-reduction
Soil type	All soils
Plant species	All species
System	Hydroponics, Soil culture in rhizoboxes
Method	Application of MnO₂-impregnated filter papers
Method description	The presence of reducing root exudates (e.g. malate, phenolics), activity of reductases and of microorganisms determines plant- availability of manganese by reduction to Mn ²⁺ . This process can be visualised by decolouration of MnO ₂ -impregnated filter papers applied to the root surface of plants grown in rhizoboxes. <i>Application:</i> Incubate fine-textured filter papers (e.g. Mn-260, Macchery & Nagel, Düren, Germany) for 7 h in a solution of 10 mM KMnO ₄ to induce the precipitation of MnO ₂ by cellulose oxidation (gently shaking). Rinse papers thoroughly with distilled water and dry on plexi- glass plates. Apply filter papers moistened with water onto the surface of plants, grown in rhizoboxes. MnIV reduction is visualized by decolouration of the paper, which proceeds within 0.5 – 48 h.
Do's, don'ts	Dry papers can be stored for months or even years without loss of colour intensity.
References	Dinkelaker B.; Hahn G.; Römheld V.; Wolf G.A.. 1993. Non-destructive methods for demonstrating chemical changes in the rhizosphere I. Description of methods Plant Soil 155/156: 67-74.

Additional information (see also colour plates on p. 530):

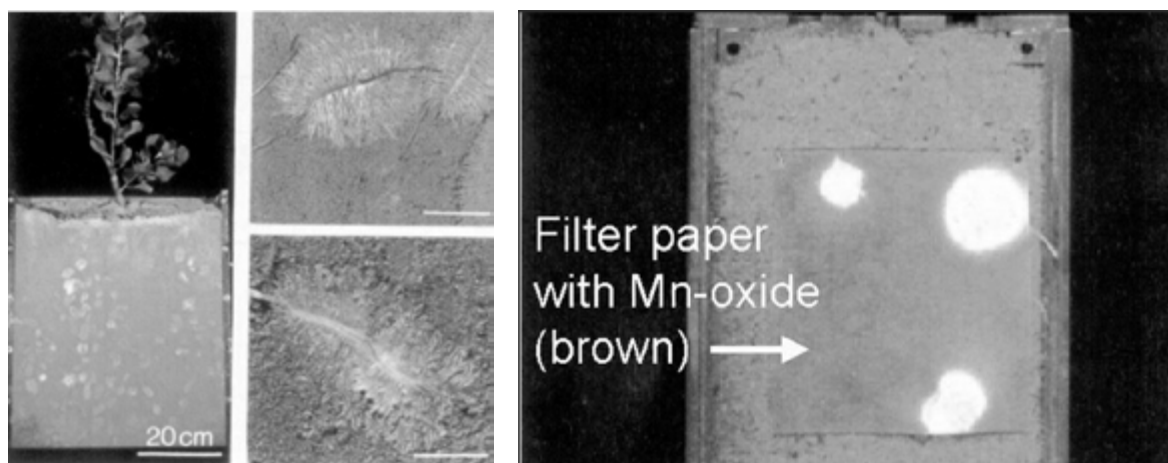

Fig. 1. Mn-reduction detected by decolouration of Mn-oxide impregnated filter paper in the rhizosphere of *Hakea undulata* (Proteaceae) grown in rhizobox culture on a P-deficient Arenosol from West Africa

ID	31_Neumann_g
Author	Neumann, Günter Institute of Plant Nutrition (330), Hohenheim University, D-70593 Stuttgart, Germany gd.neumann@t-online.de; ++49 711 459 4273
Parameter	<i>In situ</i> detection of phenolic compounds in the rhizosphere
Soil type	All soils
Plant species	All species
System	Hydroponics, Soil culture in rhizoboxes
Method	Direct UV detection; Collection with filter paper and analysis of the extracted phenolics with colorimetry or RP-HPLC
Method description	<p>Phenolic compounds are released from plant roots and are also produced by microorganisms. Many phenolics have important functions in defence reactions, plant-microbial signalling and allelopathic interactions. Due to the limited solubility in water, phenolics usually show limited diffusion and distinct accumulation zones in the rhizosphere close to the root surface.</p> <p><i>Collection:</i> Binding to sorption media, such as filter paper (e.g. Mn 260 Macchery & Nagel, Düren, Germany), cellulose-acetate-, or nylon membranes occurs by hydrophobic interactions. Sorption media are applied to the root surface of plants, grown in hydroponics or in soil using rhizobox culture or root windows, during a period of 6 - 20 h up to several days (Figs. 1 & 2). Root systems of hydroponically grown plants should be spread on a moist fleece or on filter paper, moistened with nutrient solution before the sorption media are applied.</p> <p><i>Detection:</i> Many phenolics exhibit intense autofluorescence and can therefore be easily detected under UV light (Fig. 1). Alternatively, detection is possible by spraying with Folin Ciocalteu reagent and subsequently (after 2-5 min) with 20% w/v Na₂CO₃ (Fig. 2).</p> <p><i>Quantification:</i> Extraction of phenolic compounds detected in different root zones by application of sorption media is possible using organic solvents such as methanol, ethanol, ethylacetate etc. After vacuum-concentration the extracts can be analysed quantitatively by reaction with Folin reagent (see description by Jones et al.) or single compounds can be separated and analysed by RP-HPLC (Fig. 3).</p>
Do's, don'ts, potential limitations, untested possibilities	<ul style="list-style-type: none"> • Nylon membranes show excellent properties for binding and detection of phenolics. However, re-extraction is difficult and paper or cellulose-acetate is recommended in these cases. • For quantitative analysis, carefully wash the sorption media with methanol prior to application, in order to remove potentially interfering impurities.
References	Engels, C.; Neumann, G.; Gahoonia, T.; George, E.; Schenk, M. 2000. Assessment of the ability of roots for nutrient acquisition. In: Smit, A.L.; Bengough, A.G.; Engels, C.; Van Noordwijk, M.; Pellerin, S., Van de Geijn, S.C.(eds.) Root Methods. A Handbook., Springer, Heidelberg, Germany, pp 403-459.

Additional Information (see also colour plates on p. 531):

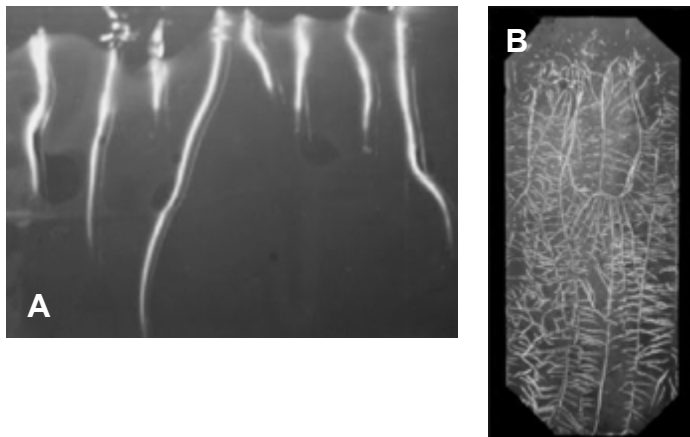

Fig. 1: Fluorescent phenolics released along the main root of cowpea seedlings germinated in filter paper (A) and from roots of soil-cultured *Phaseolus vulgaris* in rhizoboxes (B). Collection by 20-application of a nylon membrane onto the root surface.

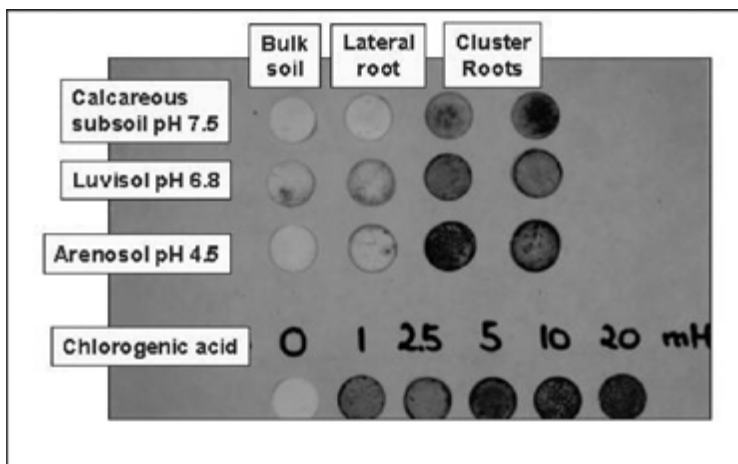
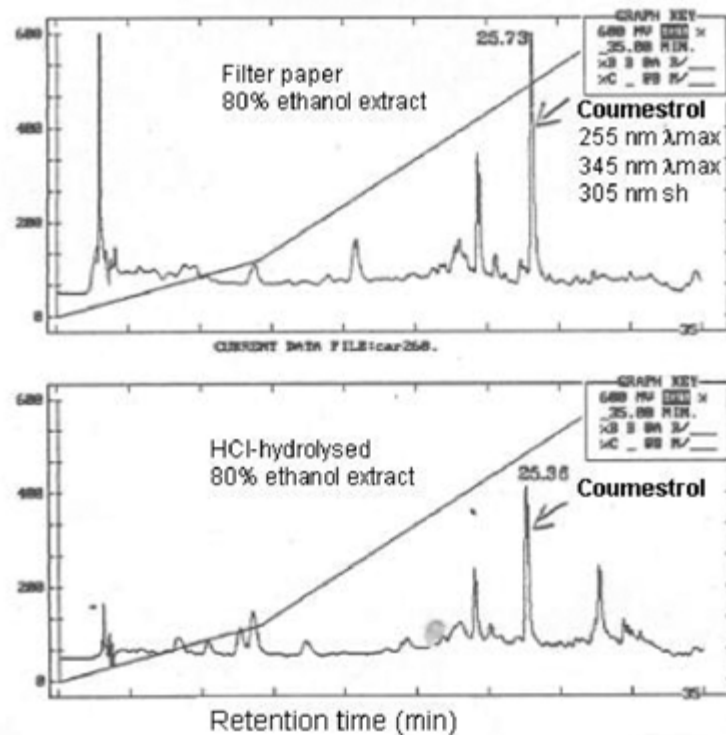

Fig. 2: Semi-quantitative detection of phenolics, released from roots of *Hakea undulata* in rhizobox culture. Collection by application of cellulose-acetate filters onto the root surface and subsequent detection with Folin reagent. Chlorogenic acid was used as a standard.

Fig. 3: RP-HPLC-separation and identification of coumestrol as the main fluorescent phenolic compound in root exudates of *Phaseolus vulgaris* seedlings, collected with filter paper.



ID	31_Neumann_h
Author	Neumann, Günter Institute of Plant Nutrition (330), Hohenheim University, D-70593 Stuttgart, Germany; gd.neumann@t-online.de; ++49 711 459 4273
Parameter	Quantitative determination of sucrose and reducing sugars in root exudates and soil solution
Soil type	All soils
Plant species	All species
System	Hydroponics, Soil culture in rhizoboxes
Method	Colorimetry
Method description	<p>The method describes a rapid spectrophotometric method for detection of low molecular weight sugars in root exudates and rhizosphere soil solution (for collection see chapter 1.3.) in the low ppm range, accounting for the limited volumes and the low sugar concentrations in many exudate samples.</p> <p><i>Application:</i> Sample pH approx. 5.0. (adjust with 0.1 M NaOH if necessary). Mix 62.5 µL sample + 12.5 µL invertase solution + 50 µL Na-acetate buffer pH 4.8. Incubate 2 h at 30°C. Add 625 µL colour reagent and boil for 4 min. Centrifugation at 5 min 12000 rpm to remove precipitates. After cooling, photometric analysis at 415 nm (1 ml microcuvettes, or microplate reader).</p> <p><i>Reagents:</i> Solution A: 1.) 1.47 g Trisodiumcitrate x 2H₂O 2.) 0.15 g CaCl₂ x 2 H₂O 3.) 2.0 g NaOH Dissolve 1.), 2.), 3.) separately in each 20 mL dist. H₂O Combine 1.) + 2.) and finally add 3.) and adjust volume to 100 mL Colour reagent: 0.5 g Hydroxybenzoic acid-hydrazide in 100 mL solution A (slightly yellow, to be prepared daily) 0.2 M acetate buffer: adjust pH of 0.2 M acetic acid to pH 4.8 by addition of 0.2 M Na-acetate solution. Invertase solution: 10 mg yeast Invertase (Grade VII) (Sigma I-4504) + 50mL H₂O + 50mL 0.2 M Na-acetate buffer pH 4.8 Calibration with glucose: 0, 1, 5, 10, 20, 30, 40, 60, 80, 90 µg/mL</p>
Do's, don'ts, potential limitations, untested possibilities	<ul style="list-style-type: none"> • Determination of reducing sugars only is possible by omitting the invertase treatment. Determining the difference between total sugars and reducing sugars represents the content of sucrose. • Don't prepare more than 25 samples simultaneously, because the colour complex exhibits stability for approx. 40 min. • Coloured samples should be pre-purified by adding 10-20 mg charcoal per 100 µL sample volume, vigorous mixing and removal of charcoal by centrifugation.
References	Blakeney, A.B.; Mutton, L.L. 1980. A simple colorimetric method for the determination of sugars in fruit and vegetables. J. Sci. Food Agri. 31: 889-897

ID	31_Neumann_i
Author	Neumann, Günter Institute of Plant Nutrition (330), Hohenheim University, D-70593 Stuttgart, Germany gd.neumann@t-online.de; ++49 711 459 4273
Parameter	<i>In situ</i> detection of root-induced FeIII-reduction
Soil type	All soils
Plant species	All species
System	Hydroponics, Soil culture in rhizoboxes
Method	Application of agar gels containing Fe redox indicators
Method description	<p>In aerated soils, activity of reductase and the presence of reducing root exudates (e.g. malate, phenolics), determines plant availability of Fe by reduction of Fe-III-oxides to Fe²⁺. This process can be visualised by application of agar gels containing Fe redox indicators, to the root surface of plants grown in hydroponics or in rhizoboxes.</p> <p><i>Application:</i> Solutions of agar (1.0% w/v) or agarose (1.0% w/v) are prepared by boiling. After cooling to 50°C, 100 µM Fe-III-EDTA and 300 µM BPDS (bathophenanthroline-disulfonic acid) as chelator for Fe²⁺ is added. Alternatively, gels can be prepared with 100 µM Fe-III-EDTA, 10 mM MES buffer pH 4.5, and 200 µM ferrozine (3-(2-pyridyl) 5,6-diphenyl-1,2,4-triazine-p,p'-disulfonic acid). Pour the solidifying agar solution into flat perspex cuvettes to obtain gel sheets with 3 mm thickness. Place agar sheets onto the root surface of plants grown in rhizoboxes or hydroponic culture, or use the solidifying agar solution for embedding of the roots. Red (BPDS) or violet (Ferrozine) colouration, indicating FeIII reduction and subsequent Fe²⁺ complexation, becomes visible after 30 min to several hours (Fig. 1).</p> <p><i>Quantitative spectrophotometric determination</i> of Fe-reduction is possible by incubating plant roots in nutrient solution (pH 5.4), containing 100 µM Fe-III-EDTA and 300 µM Ferrozine. After defined time periods, aliquots of the solution are removed and measured spectrophotometrically at 562 nm.</p>
Do's, don'ts, potential limitations, untested possibilities	<ul style="list-style-type: none"> • Cover agar sheets with plastic foil to avoid evaporation. • Incubate in the dark.
References	<p>Dinkelaker, B.; Hahn, G.; Römheld, V.; Wolf, G.A. 1993. Non-destructive methods for demonstrating chemical changes in the rhizosphere I. Description of methods Plant Soil 155/156: 67-74.</p> <p>Engels, C.; Neumann, G.; Gahoonia, T.; George, E.; Schenk, M. 2000. Assessment of the ability of roots for nutrient acquisition. In: Smit, A.L.; Bengough, A.G.; Engels, C.; Van Noordwijk, M.; Pellerin, S., Van de Geijn; S.C.(eds.) Root Methods. A Handbook., Springer, Heidelberg, Germany , pp 403-459.</p>

Additional information (see also colour plates on p. 531)

Fig. 1: FeIII reduction along roots of cucumber (A) grown in hydroponics and of peanut in rhizobox culture (B) with or without Fe supply. Detection by formation of red Fe^{2+} complexes with BPDS.

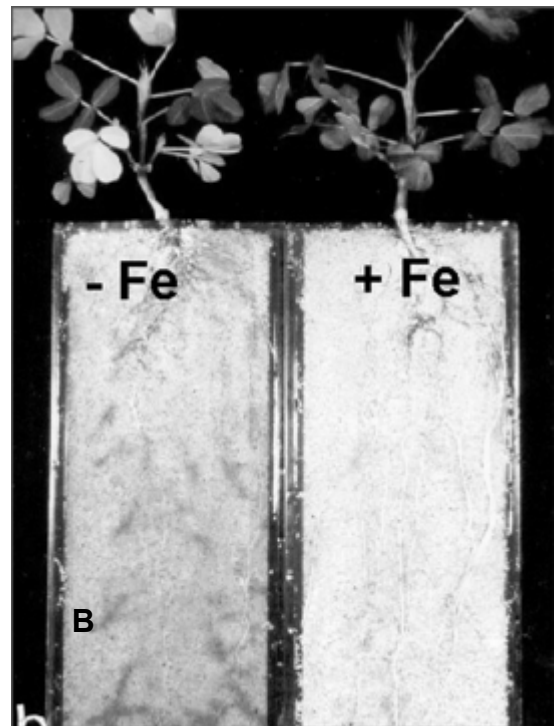
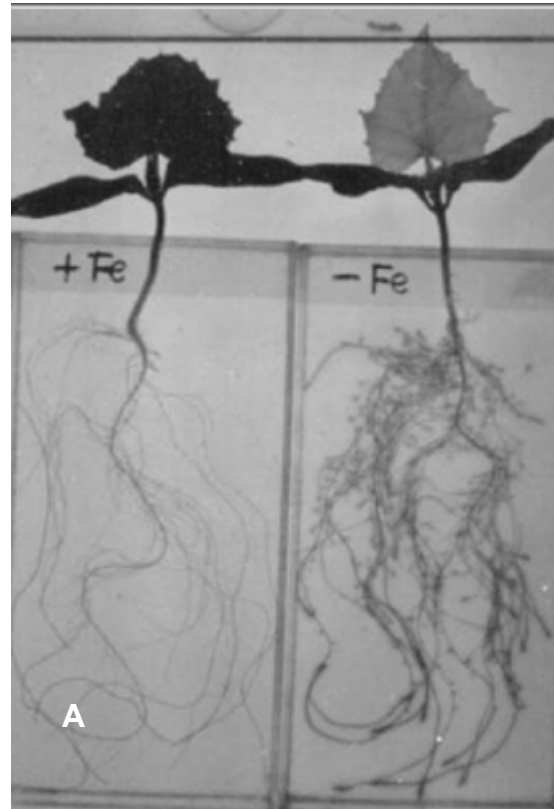

ID	31_Neumann_j
Author	Neumann, Günter Institute of Plant Nutrition (330), Hohenheim University, D-70593 Stuttgart, Germany gd.neumann@t-online.de; ++49 711 459 4273
Parameter	<i>In situ</i> detection of acid phosphatase in the rhizosphere
Soil type	All soils
Plant species	All species
System	Hydroponics, Soil culture in rhizoboxes
Method	Application of filter papers soaked with artificial substrates
Method description	<p>Acid phosphatases are produced by micro-organisms and are also released from plant roots, particularly under conditions of P-limitation. Artificial substrates for acid phosphatase, yielding coloured products after cleavage of P_i can be employed to localize and even quantify acid phosphatase activity in the rhizosphere.</p> <p><i>Application:</i> <i>Substrate solution:</i> Dissolve 37.5 mM 1-naphtyl phosphate in 50 mM trisodium-citrate buffer pH 5.6 (adjusted with HCl). Dissolve 2.7 mM Fast Red TR in 50 mM citrate buffer pH 5.6. Mix naphtyl phosphate solution and Fast-Red solution in a ratio 1:10 v/v (= substrate solution).</p> <p><i>Staining:</i> Soak filter paper with substrate solution and apply to the root surface of plants grown in hydroponics or in rhizoboxes. Depending on the phosphate activity level, P hydrolysis from naphtylphosphate is visualised as reddish brown colouration within several minutes up to 2 h. Use filter paper with a high soaking capacity (e.g. Whatman 3MM) to avoid substrate depletion in the reaction zone. During the incubation period, substrate solution may be repeatedly applied to the paper with a pasteur pipette. Substrate solution is toxic and must be prepared daily and stored in a dark bottle.</p>
Do's, don'ts, potential limitations, untested possibilities	<ul style="list-style-type: none"> • Other substrates such as 4-methylumbelliferyl phosphate may be used. • Instead of filter paper, alternatively, blotting membranes may be used for application to the root surface. Acid phosphatase binds to the membrane which is subsequently developed in substrate solution (Grierson et al. 2002).
References	<p>Dinkelaker, B.; Marschner, H. 1992. In vivo demonstration of acid phosphatase activity in the rhizosphere of soil-grown plants. Plant Soil 144: 199-205.</p> <p>Grierson, P.F.; Comerford, N.B.. 2000. Non-destructive measurement of acid phosphatase activity in the rhizosphere using nitrocellulose membranes and image analysis. Plant Soil 218: 49-57.</p>

Additional information (see also colour plates on p. 532):

In situ activity staining for root-secretory acid phosphatase

- **Filter paper or Nitrocellulose membranes**

Incubation with artificial substrates (e.g.) naphthyl-phosphate-Fast-Red-TR, methylumbeliferoyl(phosphate) applied to the root surface for colour development after dephosphorylation)

Potato

P-sufficient

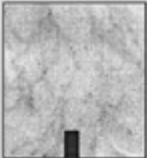

P-deficient

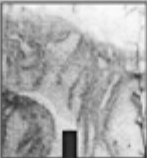

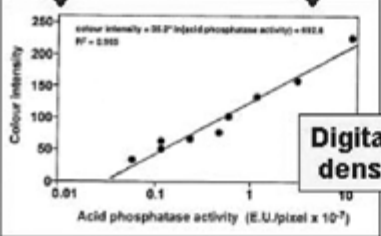

Digitalisation, densitometric quantification

Localized Sampling Techniques – Soil Culture Systems

- **Non-destructive**
- **Repeated measurements**
- **Applicable for soil and solution culture systems**
- **Spatial resolution**

But:

- **Depending on availability of specific indicator reagents (Mainly for enzyme activities)**
- **Careful adjustment of reaction conditions (substrate saturation)**

Dinkelaker and Marschner 1992 Plant Soil 144:199
Wasaki et al. 1999, Soil Sci.Plant Nutr.45: 937
Grierson et al. 2000 Plant Soil 218: 49

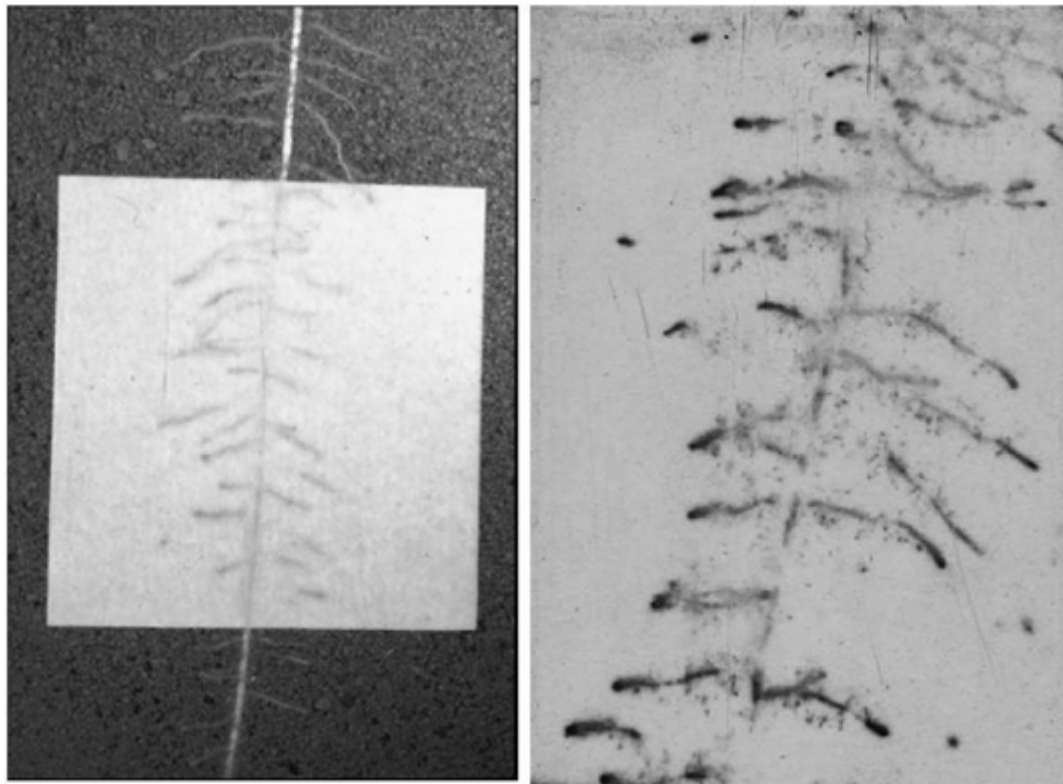

Acid phosphatase activity in the rhizosphere of soil-grown plants in rhizobox-culture by application of filter paper soaked with naphthyl-phosphate. Fast-Red TR substrate solution.

ID	32_Balesdent_a
Author	Balesdent, Jérôme Laboratoire d'Ecologie Microbienne de la Rhizosphère (UMR CNRS-CEA 163), CEA/DEVM Centre de Cadarache, 13108 Saint-Paul-lez-Durance, France ; jerome.balesdent@cea.fr ; +33 4 4225 7754
Parameter	Nature and dynamics of rhizodeposited organic carbon
Soil type	any
Plant species	any
System	mesocosms (plant-soil systems transportable to the laboratory)
Method	Compound-specific stable isotope tracing
Method description	<p><i>Labeling experiment:</i> The plant soil systems to be studied are pulse-labelled with $^{13}\text{CO}_2$ in a closed chamber for 0.3 to 5 hours. At chosen dates after labelling, the systems are destructed or sampled. Soil is separated from the roots.</p> <p><i>Extraction and Analysis:</i> The family of molecules of interest are extracted from the soil and prepared for capillary-gas chromatography. The amount of each molecule and its $^{13}\text{C} / ^{12}\text{C}$ are determined by Gas Chromatography-Combustion-Isotope Ratio Mass Spectrometry (GC-C-IRMS). In this technique, the effluent of the chromatography column (GC 'peaks') are oxidized on line to CO_2, which is directed to a high-sensitivity isotope ratio mass spectrometer. The amount of total organic ^{13}C in the soil is analysed separately on the same sample by elemental analysis coupled with the IRMS.</p>
Do's, don'ts, potential limitations, untested possibilities	<p><i>Advantages:</i></p> <ul style="list-style-type: none"> • <i>in situ</i> (= in soil) characterization of rhizodeposited carbon and of its biotransformation products • Highly quantitative • Dynamic approach: fluxes of production and rate of decay can be approximately inferred from the kinetic analysis of the proportion of tracer $^{13}\text{C} / ^{12}\text{C}$ in the molecule. These fluxes can be related to the fluxes of carbon allocation to the plant or to the roots, which are available through isotope analysis of the plant organs. • Rhizospheric carbon is clearly defined here as root-derived (= ^{13}C-labelled) carbon. <p><i>Limitations:</i></p> <ul style="list-style-type: none"> • The root-soil separation should avoid root injury / root carbon extraction • Non-volatile (polar) compounds have to be derivatized prior to GC. <p>Untested possibilities:</p> <ul style="list-style-type: none"> • in the field, with continuous labelling,
References	<p>Derrien, D.; Balesdent, J.; Marol, C.; Santaella, C. 2003. Measurement of the $^{13}\text{C}/^{12}\text{C}$ ratio of soil-plant individual sugars by gas chromatography/ combustion/ isotope-ratio mass spectrometry of silylated derivatives. <i>Rapid Communications in Mass Spectrometry</i> 17: 2626-2631.</p> <p>Derrien, D.; Marol, C; Balesdent, J. 2005. The dynamics of neutral sugars in the rhizosphere of wheat. An approach by ^{13}C pulse-labelling and GC/C/IRMS. <i>Plant and Soil</i> 267: 243-253.</p>

ID	32_Balesdent_b
Author	Balesdent, Jérôme Laboratoire d'Ecologie Microbienne de la Rhizosphère (UMR CNRS-CEA 163), CEA/DEVM Centre de Cadarache, 13108 Saint-Paul-lez-Durance, France ; jerome.balesdent@cea.fr ; +33 4 4225 7754
Parameter	Root-derived carbon: amount, quality
Soil type	any
Plant species	C4-plant in C3 environment or vice-versa
System	In the field
Method	Natural ¹³C signature of C4 plants in the field
Method description	<p>The method uses the difference in natural ¹³C / ¹²C ratio of C3 and C4 plants. When a C4 plant is grown in a soil whose organic carbon is derived from C3 plants, the measurement of the ¹³C / ¹²C ratio of any soil fraction provides an estimate of the proportion of C4-derived C in this fraction (Cerri et al., 1987; Balesdent and Mariotti, 1996). The method is described here in the case of C4 plant on C3 soil; the reciprocal case can be used as well.</p> <p>The method can typically be applied at two time scales : (i) within the growth cycle of a first C4 crop (e.g. Balesdent and Balabane, 1992). (ii) In fields repeatedly cultivated with C4 plants for years, where the aerial parts of the plant are removed : all C4-derived carbon is root-derived (e.g. Balesdent and Balabane, 1996).</p> <p>The proportion of root-derived carbon can be quantified in bulk soil C or any separable sub-fraction (DOC, particulate organic matter, CO₂, soil respiration, soil microbial biomass, etc.)</p> <p>Due to other sources of natural ¹³C enrichment, two treatments have to be compared and measured in parallel. One with the C4 plant and another (the reference) with either no plant or a C3 plant.</p> <p><i>Calculations:</i></p> <p>The proportion F of C4-derived in the sample is given by :</p> $F = (d - d_0) / D$ <p>where d is the delta ¹³C of the sample under C4 plant, d₀ is the delta ¹³C of the corresponding sample/fraction in the reference treatment. D stands for difference between the delta ¹³C of the C4 plant and the delta ¹³C of the C3 reference plant, if present, or the difference between the delta ¹³C of the C4 plant and d₀, if the reference has no plant (Balesdent and Mariotti, 1996).</p> <p>The amount of root-derived carbon is F x C; where C is the amount of carbon in the sample.</p> <p><i>Analysis:</i></p> <p>The ¹³C / ¹²C is measured on high sensitivity isotope ratio mass spectrometer coupled with an elemental analyser or other introduction devices.</p> <p>The machine generally provides the total carbon concentration of the sample, allowing quantification in the same single measurement. The amount, grain-size, characteristics and properties of samples have to be determined in coordination with the mass-spec people. Current GC-MS, LC-MS and ¹³C NMR are not sensitive enough for this measurement.</p> <p>The measurement of the ¹³C / ¹²C of CO₂, when performed with trapping systems, requires specific precautions to avoid sample contamination.</p>

<p>Do's, don'ts, potential limitations, untested possibilities</p>	<p><i>Advantages:</i></p> <ul style="list-style-type: none"> • In the field, no specific experimentation required • Natural labelling is costless and large-scale. <p><i>Also possible:</i></p> <ul style="list-style-type: none"> • Applicable to CO₂ fertilized systems (face, tunnels, open top etc.), where the additional CO₂ is derived from a source naturally depleted in ¹³C, e. g., methane. (Ineson et al., 1996) • Can estimate the C3 / C4 origin of carbon in communities of mixed C3 and C4 plants. <p><i>Limitations:</i></p> <ul style="list-style-type: none"> • Requires C3 vegetations in C4 soil or C3 and C4 crops in any soil. • The main limitation is the sensitivity. The signal of the natural label (difference in between C3 and C4 plants), δ, is ca. 15 $\delta^{13}\text{C}\%$. In the best conditions, the confidence on the analysis of $\delta - \delta_0$ (the difference between the sample of interest and the control sample) is 0.2 $\delta^{13}\text{C}\%$. This implies that (i) the sensitivity on the estimate of the absolute amount of root-derived C is very dependent on the proportion (dilution) of the latter in the soil C; (ii) root-derived C in soil organic fractions where this proportion is less than 2%, is not detected; this is often the case for bulk soil C during the growing season of a current crops; (iii) in the case of fractions calculated by difference between separates (e.g. microbial biomass by fumigation extraction), the error is propagated towards much worse values. Due to this low sensitivity, a numerical simulation before the study is recommended. • The methods should not be applied to plants grown in chambers where the isotopic composition of the CO₂ is not strictly controlled. In the case of plants grown in chambers, the labelling with artificially ¹³C-enriched CO₂ should be clearly preferred, due to its considerably higher resolution. The same comment applies to experiments introducing a labelled substrate (e.g. sugar) in the rhizosphere. <p><i>Untested possibilities:</i> Analysis of organic root-derived C at the molecular level using GC-C-IRMS.</p>
<p>References</p>	<p>Cerri, C.; Feller, C.; Balesdent, J.; Victoria, R.; Plenecassagne, A. 1985. Application du traçage isotopique naturel en ¹³C à l'étude de la dynamique de la matière organique dans les sols . Comptes Rendus de l'Académie des Sciences. Paris, 300, série II, 9 : 423-428.</p> <p>Balesdent, J.; Balabane, M. 1992. Maize-root derived soil organic carbon estimated by natural ¹³C abundances. Soil Biol. Biochem. 24: 97-101.</p> <p>Balesdent, J.; Balabane, M. 1996. Major contribution of roots to soil carbon storage inferred from maize cultivated soils. Soil Biol. Biochem. 28: 1261-1263.</p> <p>Balesdent, J.; Mariotti, A. 1996. Measurement of soil organic matter turnover using ¹³C natural abundances. In: Boutton, T.W.; Yamasaki, S.I. (eds.) Mass Spectrometry of Soils, Marcel Dekker Inc., New York, pp. 83-111.</p> <p>Ineson, P.; Cotrufo, M.F.; Bol, R.; Harkness, D.D. 1996. Quantification of soil carbon inputs under elevated CO₂: C-3 plants in a C-4 soil. Plant Soil 18: 345-350.</p> <p>Rochette, P.; Flanagan, L.B.; Gregorich, E.G. 1999. Separating soil respiration into plant and soil components using analyses of the natural abundance of carbon-13. Soil Sci. Soc. Am. J. 63: 1207-1213.</p>

ID	32_Dennis
Author	Dennis, Paul ¹⁾ ; Jones, Davey ²⁾ . ¹⁾ Rothamsted Research, Harpenden, Hertfordshire, AL5 2JQ, UK paul.dennis@bbsrc.ac.uk; ++44 1582 763133 ²⁾ School of Agricultural and Forest Sciences, University of Wales, Bangor, Gwynedd, LL57 2UW, UK d.jones@bangor.ac.uk; ++44 1248 382579
Parameter	¹⁴C pulse labelling and allocation imaging
Soil type	All soils
Plant species	All species
System	Rhizoboxes
Method	¹⁴C pulse labelling of plant material and ¹⁴C allocation imaging using storage phosphor screens
Method description	<p><i>Concept:</i> Whole shoots or single leaves maybe exposed to an atmosphere enriched with ¹⁴CO₂ using a small plastic sheath. Subsequent allocation of recent photosynthates may then be imaged by scanning a phosphor storage screen exposed against the root/soil profile of a rhizotron.</p> <p><i>Sheath:</i> A lidless 200 µl microtube was fixed to the face of one of two 50 x 90 x 0.2 mm sheets of Mylar that were joined by heat sealing on 3 edges leaving one of the 50 mm edges open (Fig 1). High density (HD) urethane foam sticky tape was stuck around the inner rim of the opening and a small hole was created in the Mylar sheet facing the microtube to facilitate dispensing of liquids into the microtube.</p> <p><i>Labelling:</i> 5 µCi NaH¹⁴CO₃ in 2 µl 150 mM Tris + HCl pH 8 is dispensed into the microtube inside the Mylar sheath. The sheath is then placed over the shoots of a plant grown in a soil rhizotron. The HD urethane foam is pressed together with clips to form an air-tight seal around the stem of the plant. An excess of concentrated HCl (8 µl) is dispensed into the microtube and immediately afterwards the aperture is sealed with sticky tape. The plant is pulse labelled for 45 min under plant growth lamps to ensure maximum ¹⁴CO₂ uptake. Any ¹⁴CO₂ remaining after the labelling period is exhausted in a fume cupboard by removing the sheath from the plant. The plant is then replaced under the growth lamps to photosynthesise for a further 2.5 h to allow translocation of the ¹⁴C labelled photosynthates.</p> <p><i>Phosphor imaging of ¹⁴C allocation patterns:</i> After labelling, the plant/soil profile is covered with a 0.8 µm thick Mylar film onto which a storage phosphor screen (Eastman Kodak Company, USA) is pressed for 16 h in a dark cupboard. The storage phosphor screen is then scanned (Typhoon 8600, Molecular Dynamics, USA).</p> <p><i>Generating overlay images:</i> After phosphor imaging a photograph of the plant/soil profile is captured. The photograph and phosphor image can be opened in Adobe Photoshop 7.0. Dragging the phosphor image over the photograph creates an overlay. Selection of 'Linear Burn' in the 'General Blending' options within the 'Layer Style' options blends the images.</p>

Do's, don'ts, potential limitations, untested possibilities	<ul style="list-style-type: none"> • All labelling should be conducted in a laboratory approved work with radioactive materials. Labelling should be conducted in a fume cupboard to reduce risk of exposure to $^{14}\text{CO}_2$. • Larger sheaths can be used for older plants and rhizoboxes of different sizes can be used to grow plant of different ages (Fig 2). Large root systems can be imaged using multiple storage phosphor plates. • Labelling method is also suitable for ^{13}C.
---	---

Additional information (see also colour plates on p. 533):

Fig 1. (right) Diagram of labelling setup.

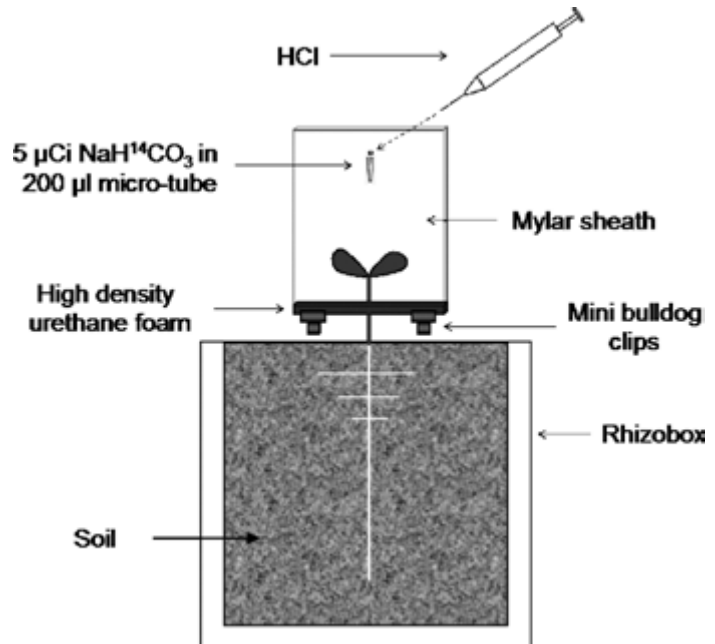
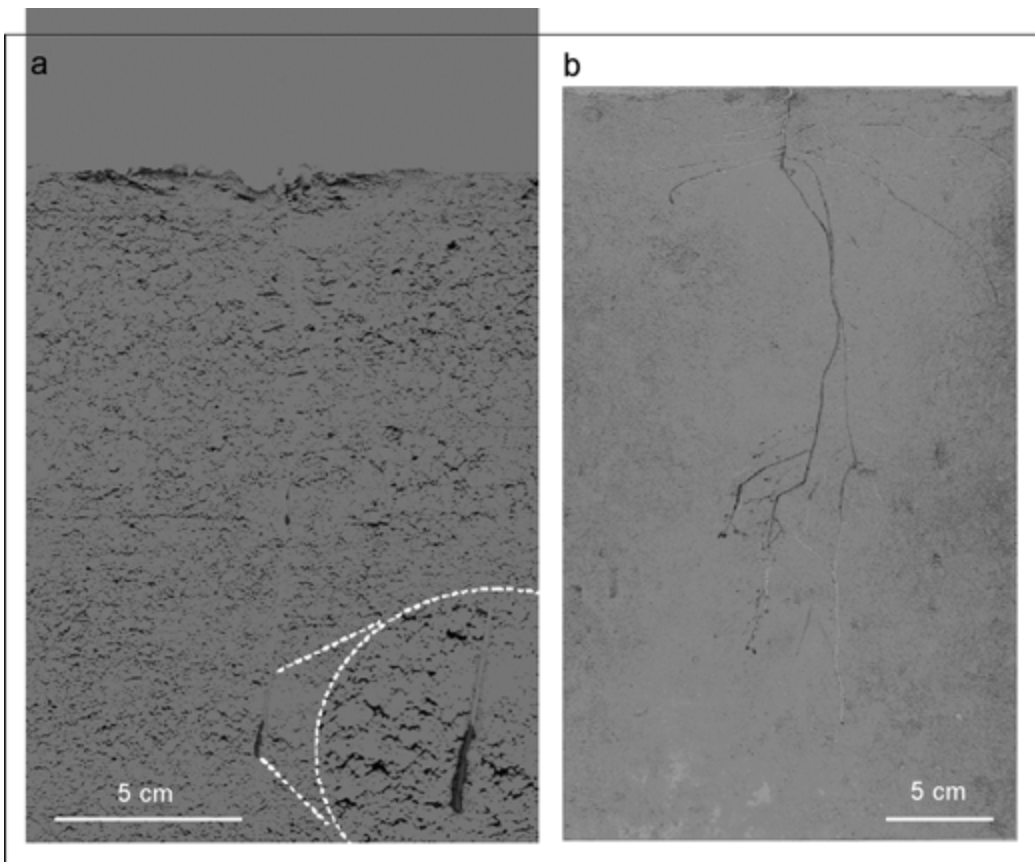

Fig 2. (below) (a) Carbon allocation in a 6 day old Brassica napus plant. Overlay image generated from a phosphor image and photograph (b) Carbon allocation pattern in a 32 day old B.napus plant.



ID	32_Finlay
Author	Finlay, Roger Dept. Forest Mycology & Pathology, SLU, Box 7026, Uppsala, Sweden SE-750 07; Roger.Finlay@mykopat.slu.se; ++46 18 67 1554
Parameter	Distribution of radioactive isotope tracers in the mycorrhizosphere
Soil type	acid forest soils
Plant species	Pine, Birch, Spruce
System	field soil or artificially manipulated, spatially heterogeneous substrates
Method	Electronic autoradiography of flat laboratory microcosms
Method description	Two dimensional patterns of distribution of radioactive tracer isotopes can be measured in flat microcosms containing plants and different mycorrhizal fungi. The method replaces conventional x-ray film and is more direct than phosphor imaging since an image is obtained directly on the screen.
Do's, don'ts, potential limitations, untested possibilities	<ul style="list-style-type: none"> • The counting and carrying gas cylinder connected to the instant imager must be switched on several hours in advance of using the machine to allow a steady flow of gas through the detector. • The microcosms must be no thicker than 1 cm and sharp edges should be masked with thick neoprene to prevent damage to the detector. • Disposable mylar screens can be re-used but must be replaced when punctured or contaminated to prevent contamination of the detector. • Different areas can be identified and activity within these can be integrated using the accompanying software.
References	<p><i>Description of or references for all methods, example of results with interpretation:</i></p> <p>Lindahl, B; Stenlid, J.; Olsson, S.; Finlay, R.D. 1999. Translocation of ³²P between interacting mycelia of a wood-decomposing fungus and ectomycorrhizal fungi in microcosm systems. <i>New Phytologist</i> 144: 183-193.</p> <p>McKendrick, S.L.; Leake, J.R.; Read, D.J. 2000. Symbiotic germination and development of myco-heterotrophic plants in nature: transfer of carbon from ectomycorrhizal <i>Salix repens</i> and <i>Betula pendula</i> to the orchid <i>Corallorhiza trifida</i> through shared hyphal connections. <i>New Phytologist</i> 145: 539-548.</p> <p>Whiting, S.N.; Leake, J.R.; McGrath, S.P.; Baker, A.J.M. 2000. Positive responses to Zn and Cd by roots of the Zn and Cd hyperaccumulator <i>Thlaspi caerulescens</i>. <i>New Phytologist</i> 145: 199-210.</p> <p>Leake, J.R.; Donnelly, D.P.; Saunders, E.M.; Boddy, L.; Read, D.J. 2001. Rates and quantities of carbon flux to ectomycorrhizal mycelium following ¹⁴C pulse labelling of <i>Pinus sylvestris</i> seedlings: effects of litter patches and interaction with a wood-decomposer fungus. <i>Tree Physiology</i> 21: 71-82.</p> <p>Lindahl, B.; Finlay, R.D.; Olsson, S. 2001. Simultaneous bidirectional translocation of ³²P and ³³P between wood blocks connected by mycelial cords of <i>Hypholoma fasciculare</i>. <i>New Phytologist</i> 150: 189-194.</p>
Additional information	Electronic autoradiography provides a convenient alternative to film-based autoradiography and is suitable where dynamic measurements are necessary. The method was originally developed for two-dimensional scanning of radioactivity in gels, blots and TLC plates, where activity is counted directly from the sample. The sample is loaded directly into the

scanner and an image is displayed on an associated computer screen as counts accumulating in real time. Results are expressed in counts per minute (CPM) with the accuracy of liquid scintillation counting without scraping or cutting the sample. The method is five times faster than film with greater than five logs of dynamic range. Conventional uses of the method include quantitative analysis of dry and wet polyacrylamide and agarose gels, Southern, northern and western blots, dot blots and high density and colony hybridisations; C-14 metabolism and P-32 adduct assays on TLC samples. Recently the method has been applied to analyse radioisotope distribution in flat soil microcosms containing interacting plant roots and symbiotic mycorrhizal fungi (Lindahl et al. 1999, Leake et al. 2001), wood-decomposing fungi (Lindahl et al. 2001) and heavy metal accumulating plant roots (Whiting et al. 2000). A wide range of radioactive isotopes can be quantified including S³⁵, P³², P³³, C¹⁴, I¹²⁵, C¹¹, F¹⁸, In¹¹¹ and mTc⁹⁹. The principal limitation of the method is signal quenching by the sample itself so that thin microcosms are to be preferred but the scanner will accommodate samples up to 1 cm in thickness. The imaging area is 20 x 24 cm and the resolution of the scans depends upon the energy of the isotope being used. P³² can be counted with a resolution of 1.5mm.

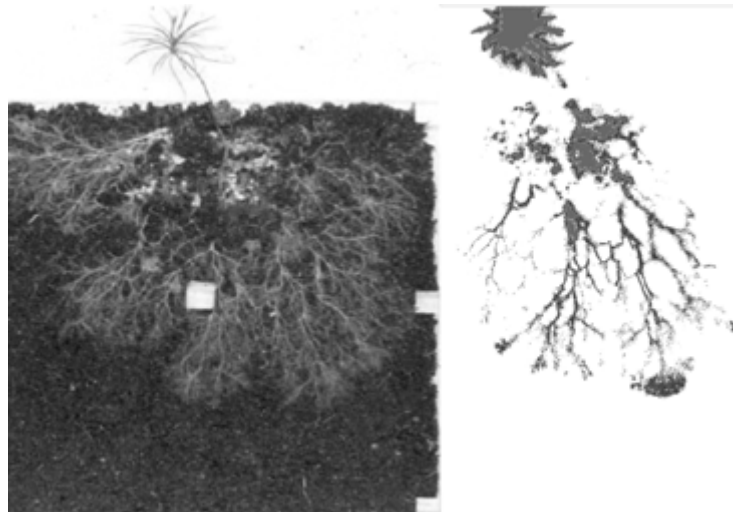

Fig. 1. scan of a microcosm containing a mycorrhizal pine seedling labelled with ¹⁴C CO₂. The distribution of carbon to the margin of the ectomycorrhizal mycelium is evident (see also colour plate on p. 534).

ID	32_Gioacchini
Author	Gioacchini, Paola; Ciavatta, Claudio; Gessa, Carlo Emanuele <i>Alma Mater Studiorum</i> University of Bologna , Department of Agroenvironmental Sciences and Technologies, Viale Fanin, 40- 40127 Bologna, Italy; pgioacch@agrsci.unibo.it; ++39 051 2096212
Parameter	Soil Total Organic Carbon and $\delta^{13}\text{C}$
Soil type	All types of soil
System	e.g. field soil, microcosm
Method	Elemental analysis and continuous flow-isotope ratio mass spectrometry (CF-IRMS)
Method description	<p>Before analysing soil samples for total organic carbon and its isotopic signature, inorganic carbon eventually present must be eliminated.</p> <p><i>Sample preparation</i> Air dried and finally ground soil samples are weighed in silver capsules for elemental analysis (5x9 mm) and placed in a sample holder plate, which is heated at 80 °C on an electric heater. The amount of soil varies between 10 and 20 mg for soil total organic carbon content comprised between 2 and 1%. Afterwards 50% (v:v) HCl solution is added drop by drop with a Hamilton syringe in the capsules in order to eliminate the inorganic carbon. The amount of acid solution that has to be added depends on the amount of inorganic carbon in the sample. The HCl reacts immediately with carbonates causing effervescence and the addition of the acid solution is stopped when no more effervescence is observed. The capsules are kept on the electric heater until the soil is dried, then the holder plate is cooled in a dessicator before preparing the capsules for the analysis at the mass spectrometer.</p> <p><i>Analysis</i> The samples are analysed by elemental analysis and continuous flow- isotope ratio mass spectrometry (CF-IRMS). The isotopic values of soil organic carbon is expressed as delta (δ) notation where: $\delta\text{‰} = [(R_{\text{sample}}/R_{\text{standard}}) - 1] \times 1000$, and R_{sample} and R_{standard} is $^{13}\text{C}/^{12}\text{C}$ of the sample and the standard respectively. The international standard is the Vienna Pee Dee Belemnite.</p>
Do's, don'ts, potential limitations, untested possibilities	A potential source of error is the incomplete elimination of inorganic carbon, however, the $\delta^{13}\text{C}$ value itself can be considered as an indirect validation of effectiveness of the acid attack. The isotopic signature of the inorganic carbon, actually, is around 0‰ $\delta^{13}\text{C}$, whereas that of the organic carbon depends on the vegetation (C_3 and C_4 plants have different isotopic signatures) and is always negative. If the isotopic value measured is higher than expected on the basis of the soil vegetation, this could indicate that some inorganic carbon is still present after the acidic treatment.
References	<p><i>Characterisation of soil organic carbon in long-term amendment trials:</i> Francioso, O.; Sanchez-Cortés, S.; Corrado, G.; Gioacchini, P.; Ciavatta, C. 2005. Spetr. Letters. 38:283-291.</p> <p><i>Seasonal changes in microbial nitrogen in an old broadleaf forest and in a neighbouring young plantation.</i> Tonon, G.; Boldreghini, P.; Gioacchini, P. 2005. Biol. Fertil. Soils. 41:101-108</p> <p><i>The origin of soil organic C, dissolved organic C and respiration in a long-term maize experiment in Halle, Germany, determined by ^{13}C natural abundance.</i> Flessa, H.; Bernard, L.; Balint, H.; Merbach, W. 2000. J. Plant Nutr. Soil Sci. 163: 157-163.</p>

ID	32_Hacin
Author	Hacin, Janez University of Ljubljana, Biology centre, Večna pot 111, 1000 Ljubljana, Slovenia Janez.Hacin@uni-lj.si
Parameter	Photosynthate partitioning to root and nodule meristems
Soil type	Plant nutrient solution
Plant species	Soybean
System	Plastic growth pouch, Split-root system (see 11_Hacin)
Method	Visualization of ¹⁴C labelled root and nodule meristems by Eriochrome black staining and autoradiography
Method description	<p><i>Root staining:</i> After pulse labelling plants are placed on ice, roots separated from the shoot and immersed for 10-15 minutes in Eriochrome black staining solution (50 ml) contained in a petri dish. Excess stain is rinsed by transferring the roots through half strength plant nutrient solution (PNS) or 0,1M phosphate buffer saline (PBS). Store in PNS, or PBS for at least 24 hours or longer (weeks) in the fridge (2-4° C). Roots clear during storage and meristematic structures become clearly visible. For longer storage periods Thimerosal (0,1%) should be added to the storage solution. Test tubes (50 ml) have proven suitable for storage of large number of samples. Observe under dissecting microscope using dark field bottom illumination and keep the roots wet – petri dish is quite suitable for observation and manipulation of the roots. Root and nodule meristems can be excised and their radioactivity determined by scintillation counting.</p> <p><i>Autoradiography:</i> Stained and rinsed roots are stored in PNS, or PBS overnight at 4° C, dried on a paper towel, layed out and clamped (using paper clips) between two sheets of weighing paper and glass slides, then freeze dried, pressed between two metal plates in a vice and re-clamped between glass slides for exposure with Kodak X-OMAT AR film at room temperature. AR film is placed directly on roots in complete darkness.</p>
Do's, don'ts, potential limitations, untested possibilities	<p><i>Preparation of staining solution:</i> dissolve 0,144 g Eriochrome black T in 16 ml dimethyl sulfoxide (DMSO) and add 80 ml of chelating solution (50 ml DMSO, 20 ml H₂O, 10 ml 0,1M AlCl₃, 10 ml 1,0 M CH₃COOH; with pH adjusted to 5,2 with 1M NaOH and the volume to 100 ml with distilled H₂O). Eriochrome black A can be used instead of Eriochrome black T and N-N dimethyl formamide instead of DMSO.</p> <p><i>Autoradiography precautions:</i> Weighing paper prevents the roots to stick to glass or metal during handling. Exposure time may depend on the amount of label used. With 1.67-2,96 MBq per plant, 2-3 day exposure was required to obtain clear autoradiographs.</p>
References	Hacin, J.; Bohlool, B.B.; Singleton, P.W. 1997. Partitioning of ¹⁴ C-labelled photosynthate to developing nodules and roots of soybean (<i>Glycine max</i>). New Phytol. 137: 257-265

Additional information (see also colour plate on p. 534)

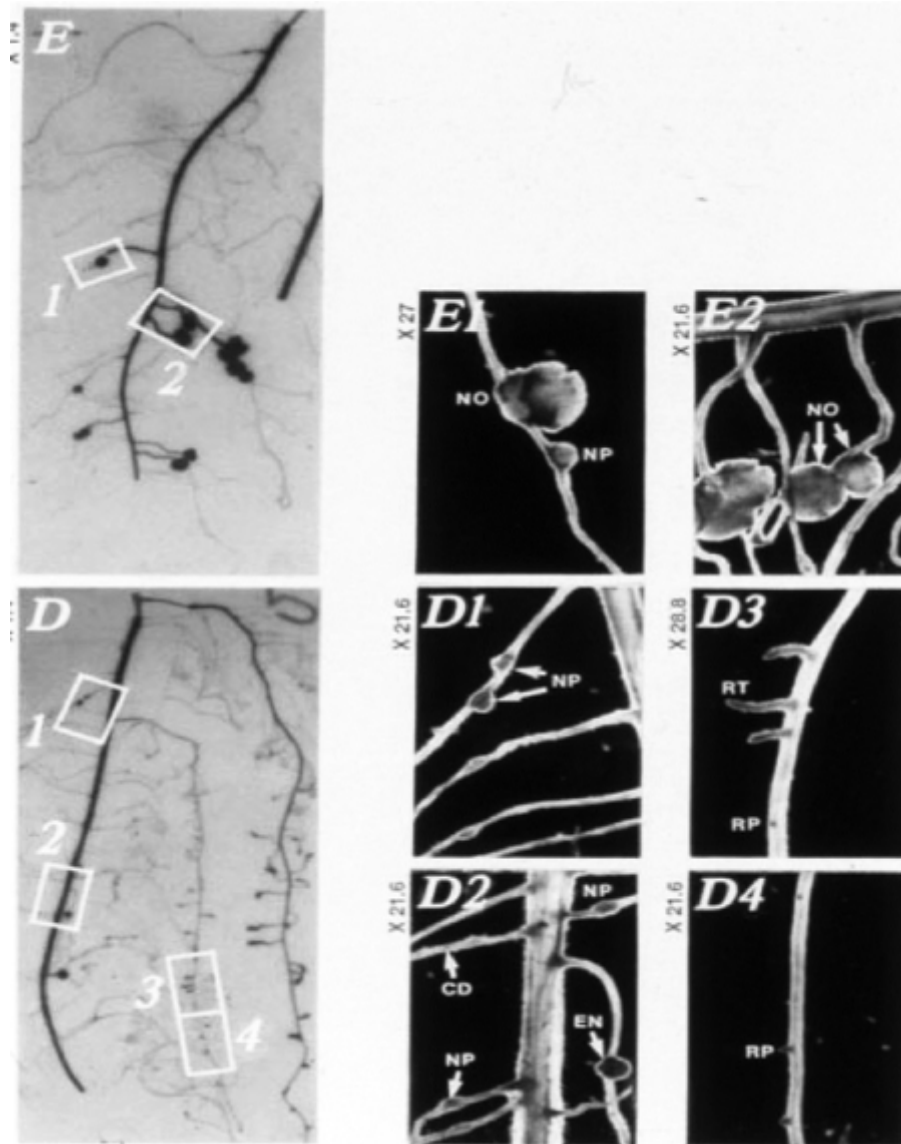

Figure 1. Autoradiographs and corresponding details on stained roots of the E-early and D- delayed inoculated split-root system of soybean. Abbreviations: NO – nodules, EN- emerging nodule, NP- nodule primordia, CD-cortical cell division centres, RP-root primordia, RT-root tips (from Hacin et al., 1997; reproduced with permission of the *New Phytologist* Trust).

ID	32_Hodge
Author	Hodge, Angela Department of Biology, Area 2, PO Box 373, University of York, YORK, YO10 5YW. U.K.; ah29@york.ac.uk; ++44 1904 328562
Parameter	Plant and AM colonised plant N capture from organic patches dual-labelled with ¹³C and ¹⁵N
Soil type	Loam soil
Plant species	Various grass species, Plantago
System	field soil, microcosms and temporally/spatially heterogeneous substrates (patches)
Method	Various microcosms
Method description	Various ¹³ C, ¹⁵ N labelled organic patches (earthworms, shoot material) produced or purchased commercially (i.e. labelled amino acids, algal cell material, urea) in microcosms (see 12_Hodge). The isotopic composition of plant material at the end of the experiments is measured by isotope ratio mass spectrometry (IRMS).
Do's, don'ts, potential limitations, untested possibilities	<ul style="list-style-type: none"> • Although uptake of intact simple forms of organic N (such as amino acids) have been reported we tend not to find this in our studies – probably due to the longer time scales we run our experiments over weeks-months rather than hours. • ¹³C can be so diluted in the plant its no longer detectable or can also be re-fixed leading to under and over-estimations of the amount captured. • To obtain an accurate picture of microbial decomposition very short time periods are required or the decomposition period is missed.
References	<p>Hodge, A. 2003. Plant nitrogen capture from organic matter as affected by spatial dispersion, interspecific competition and mycorrhizal colonization. <i>New Phytologist</i> 157: 303-314.</p> <p>Hodge, A.; Campbell, C.D.; Fitter, A.H. 2001. An arbuscular mycorrhizal fungus accelerates decomposition and acquires nitrogen directly from organic material. <i>Nature</i>, 413: 297-299.</p> <p>Hodge, A. 2001. Arbuscular mycorrhizal fungi influence decomposition of, but not plant nutrient capture from, glycine patches in soil. <i>New Phytologist</i> 151: 725-734.</p> <p>Hodge, A.; Robinson, D.; Fitter, A.H. 2000. An arbuscular mycorrhizal inoculum enhances root proliferation in, but not nitrogen capture from, nutrient-rich patches in soil. <i>New Phytologist</i> 145: 575-584.</p> <p>Hodge, A.; Stewart, J.; Robinson, D.; Griffiths, B.S.; Fitter, A.H. 2000. Competition between roots and soil micro-organisms for nutrients from nitrogen-rich patches of varying complexity. <i>Journal of Ecology</i> 88: 150-164.</p> <p>Hodge, A.; Stewart, J.; Robinson, D.; Griffiths, B.S.; Fitter, A.H. 2000. Plant N capture and microfaunal dynamics from decomposing grass and earthworm residues in soil. <i>Soil Biology and Biochemistry</i> 32: 1763-1772.</p> <p>Hodge, A.; Stewart, J.; Robinson, D.; Griffiths, B.S.; Fitter, A.H. 2000. Spatial and physical heterogeneity of N supply from soil does not influence N capture by two grass species. <i>Functional Ecology</i> 14: 645-653.</p> <p>Hodge, A.; Stewart, J.; Robinson, D.; Griffiths, B.S.; Fitter, A.H. 1999. Why plants bother: root proliferation results in increased nitrogen capture from an organic patch when two grasses compete. <i>Plant, Cell and Environment</i> 22: 811-820.</p>

ID	32_Kuzyakov
Author	Kuzyakov, Yakov Institute of Landscape Matter Dynamics, Leibniz-Centre for Agricultural Landscape Research ZALF, Eberswalder Str.84, D-15374 Müncheberg, Germany kuzyakov@zalf.de; ++49 33432 82326
Parameter	Rhizodeposition; C input by plants into the soil
Soil type	unimportant
Plant species	mainly grasses, unimportant, not trees
System	microcosm, can be used under field conditions
Method	¹⁴C (¹³C) labeling
Method description	<p>To estimate the total rhizodeposition (not only the root C, but also exudates, sloughed root cells etc.) as well as CO₂ respired by roots and microorganisms utilizing rhizodeposits in the soil (not in a sand or nutrient solution) separation between root-derived C and soil organic matter C is necessary. Labeling of shoots in ¹⁴CO₂ (or ¹³CO₂) atmosphere can be used for such separation.</p> <p><i>Procedure:</i></p> <p>The plants should be grown in pots, which allow airtight separation from the atmosphere. One day before ¹⁴C labeling, the root and shoot zones of the plants were separated by low melting point Paraffin (m.p. 42-44 °C; Merck Eurolab GmbH, Bruchsal) and overlaid with Silicon paste (NG 3170 of Fa. Thauer and Co. Dresden). The plants will be labeled in a Plexiglas chamber. Depending on the investigation aim 10¹ – 10³ kBq of ¹⁴C as Na₂¹⁴CO₃ solution can be used for each pot (plant). The chamber (Fig. 1) will be closed and 3 ml of lactic acid were added to the Na₂¹⁴CO₃ solution in a tube through a pipe on the Plexiglas chamber. This allowed complete evolution of ¹⁴CO₂ into the chamber atmosphere. The labeling took place 1 – 3 hours. In order to remove the remaining unassimilated ¹⁴CO₂, 1 – 3 hour after labeling began, CO₂ from the Plexiglas chamber was trapped by continuously pumping (100 cm³ min⁻¹) the air from the chamber through 10 ml of 1 M NaOH solution using a membrane pump. Then the upper part of the chamber was opened and the plants were grown under normal conditions.</p> <p>After the labeling the radioactivity of shoots, roots, DOC, microbial biomass and soil samples can be measured at different time periods after the labeling. The results can be presented as:</p> <ol style="list-style-type: none"> 1) Percentage of ¹⁴C added to plants after subtracting the unassimilated ¹⁴C. This form corresponds to the total assimilated ¹⁴C. 2) Percentage of ¹⁴C recovery (sum of ¹⁴C in shoots, roots, soil, ¹⁴CO₂ respired from the rooted soil). This form corresponds to the net assimilated ¹⁴C (total assimilated ¹⁴C minus shoot respiration). <p>In the same way labeling of plants in ¹³CO₂ atmosphere can be conducted.</p>
Do's, don'ts, potential limitations, untested possibilities	Only the amount of C translocated at the labeling period can be estimated. This value cannot be extrapolated for the whole plant growth period.

References

Kuzyakov, Y.; Raskatov, A.V.; Kaupenjohann, M. 2003. Turnover and distribution of root exudates of *Zea mays*. *Plant Soil* 254: 317-327.

Kuzyakov, Y.; Cheng, W. 2001. Photosynthesis controls of rhizosphere respiration and organic matter decomposition. *Soil Biol. Biochem.* 33: 1915-1925.

Kuzyakov, Y.; Ehrensberger, H.; Stahr, K. 2001 Carbon partitioning and below-ground translocation by *Lolium perenne*. *Soil Biol. Biochem.* 33: 61-74.

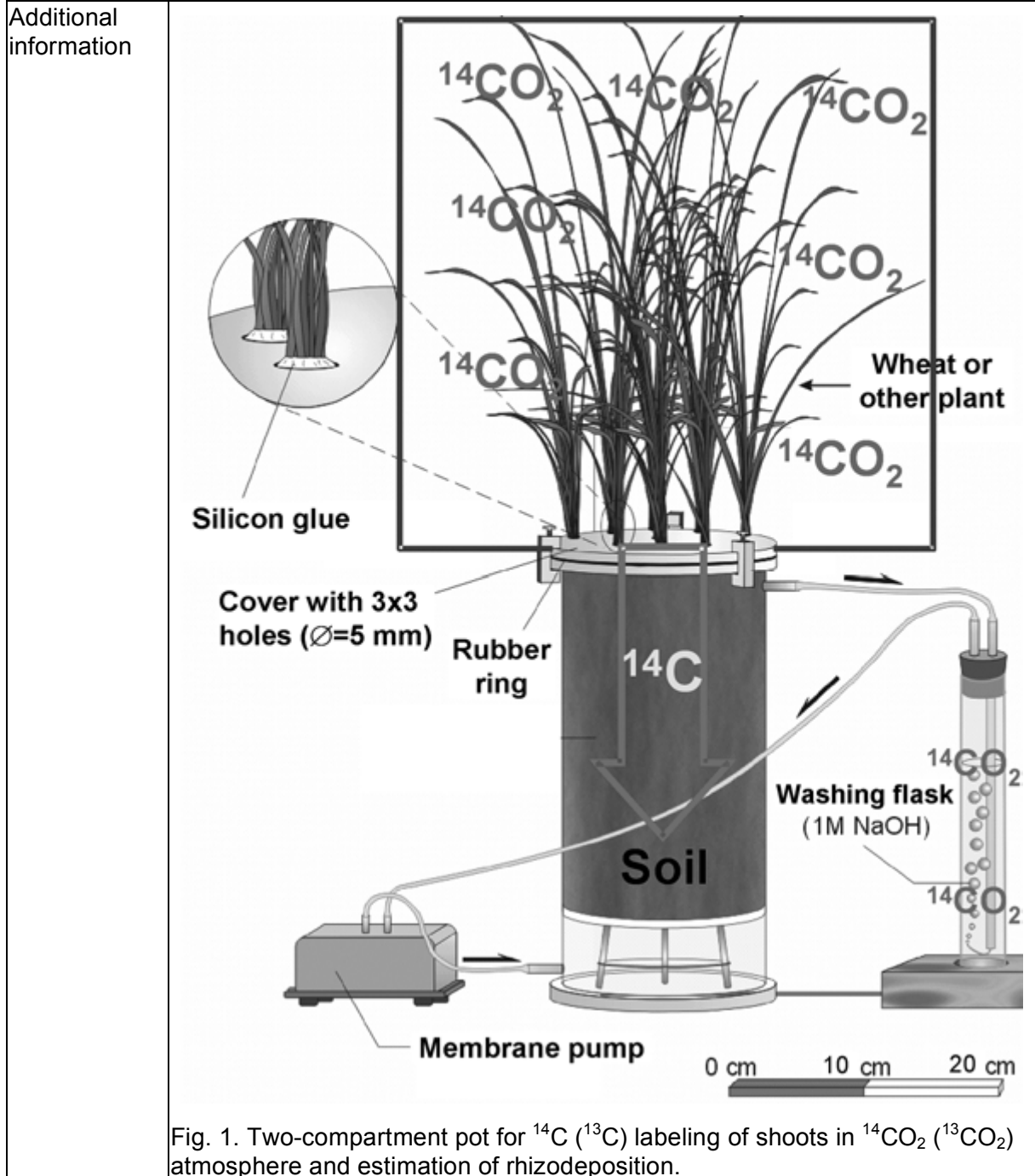





Fig. 1. Two-compartment pot for ^{14}C (^{13}C) labeling of shoots in $^{14}\text{CO}_2$ ($^{13}\text{CO}_2$) atmosphere and estimation of rhizodeposition.

ID	32_Minchin
Author	Minchin, Peter E.H. ICG-III Phytosphaere, Forschungszentrum Juelich, D 52425 Juelich, Germany; p.minchin@fz-juelich.de; ++49 2461 61 86 87
Parameter	Short-term carbon release from roots – either as gas or solute
Soil type	any
Plant species	any – but must have moderately fast phloem transport to the roots
System	hydroponic, soil
Method	¹¹C tracer experiment
Method description	¹¹ C tracer, derived from labelled photosynthate transported to the roots, is quickly found to appear in root exudate and respired gas. In a hydroponic system these two fractions can be easily separated.
Do's, don'ts, potential limitations, untested possibilities	<ul style="list-style-type: none"> • A big limitation is the short-half life (20.4 mins) that means the isotope has to be made near to the site of use, requiring a nuclear particle accelerator (cyclotron or van de Graaff). The short half-life limits measurement time to about 3hrs after labelling. • The method should work in soils, at least for the respired gas, using a stream of air to flush the tracer out for counting. The method has the advantage of being able to measure that amount of tracer within the root at the same time as that of exudate and hence has the potential for looking at what controls exudation. • Because of the increased sensitivity of monitoring ¹¹C to that of ¹⁴C, dual isotope labelling may have the potential to allow more precise early release data with ¹¹C while ¹⁴C allows a much longer measurement time. • ¹¹C is easily measured <i>in vivo</i>, and within the root solution, but for separation into gas or solute phases requires physical separation. • The time course of arrival of labelled photosynthate into the root and subsequent loss to the bathing solution is readily monitored. Hence the effect of chemical nature of the bathing solution on exudation can be easily seen.
References	Minchin, P.E.H.; McNaughton, G.S. 1984. Exudation of recently fixed carbon by non-sterile roots. <i>Journal of Experimental Botany</i> 35: 74-82.

ID	32_Nguyen
Author	Nguyen, Christophe UMR INRA-INPL(ENSAIA) "Agronomie et Environnement" BP 172 54505 Vandoeuvre les Nancy, France Christophe.Nguyen@ensaia.inpl-nancy.fr ; ++33 383 59 57 87
Parameter	Utilisation of ¹⁴C-glucose by rhizosphere microorganisms in relation to their overall activity
Soil type	Agricultural and forest soils (pH range tested 4-7)
Plant species	maize, ryegrass, Medicago, Birch
System	Field and microcosm soil samples
Method	¹⁴C-glucose assay
Method description	<p><i>Labeling and incubation:</i> Addition of very low amount of ¹⁴C-glucose (typically 0.01 μg C g⁻¹ soil) to the soil to be tested. Samples incubated for 6 days at 22°C in the dark in jar containing NaOH 1M to trap the ¹⁴CO₂.</p> <p><i>Analysis:</i> The mineralised fraction (¹⁴CO₂) and the ¹⁴C recovered in the labile microbial C (¹⁴C_{FE} : flush of K₂SO₄-extractable C after fumigation of the soil sample with chloroform vapours) determined by liquid scintillation counting. The microbial activity is positively correlated with the ¹⁴CO₂ activity and negatively with the ¹⁴C_{FE} activity. Alternatively, the kinetics of the cumulative ¹⁴CO₂ can be fitted to a double exponential model whose parameters give additional information about microbial activity.</p>
Do's, don'ts, potential limitations, untested possibilities	<ul style="list-style-type: none"> • The method allows relative comparisons of overall microbial activity between rhizosphere soil samples but does not give an absolute value of the activity per sample (such as a growth rate). • The size of the sample is small and well adapted for rhizosphere studies (2-3g). • Assay also tested successfully with soil slurry. • The added C is assumed to be low enough to have no effect on microbial activity. • ¹⁴C-glucose utilisation is assumed to relate activity of bacteria, fungi and protozoa since glucose is a universal substrate. • No extraction required, assay easy and not time consuming. • The method is very sensitive since it demonstrated difference in microbial activity between soil surrounding root apex and soil surrounding branches. • In the contrary, excessive manipulation of soil during sampling may artificially stimulate microbial activity. • The assay might be applicable with ¹³C-glucose (not tested).
References	<p><i>Uptake and use of ¹⁴C-glucose by the soil microflora:</i> Nguyen, C.; Guckert, A. 2001. Short-term utilisation of ¹⁴C-[U]glucose by soil microorganisms in relation to carbon availability. Soil Biology and Biochemistry 33: 53-60.</p>

	<p><i>Description of the assay, application to rhizosphere soil samples</i> Nguyen, C.; Henry, F. 2002. A ^{14}C-glucose assay to compare microbial activity between rhizosphere soil samples. <i>Biology and Fertility of Soils</i>, 35 : 270-276.</p>												
Additional information	<div style="display: flex; justify-content: space-around; align-items: center;"> <div style="text-align: center;">  <p>Control maize</p> </div> <div style="text-align: center;"> <p>Soil adhering to roots</p> <table border="1" style="margin: auto;"> <tr> <td style="text-align: center;">2,6 a</td> <td style="text-align: center;">2,1 b</td> <td style="text-align: center;">2,0 b</td> </tr> <tr> <td style="text-align: center;">Apex+ root hair zone</td> <td style="text-align: center;">Branches</td> <td style="text-align: center;">Distal zone</td> </tr> </table> </div> <div style="text-align: center;"> <p>Bulk soil</p>  <p>1,1 c</p> </div> </div> <div style="display: flex; justify-content: space-around; align-items: center;"> <div style="text-align: center;">  <p>Defoliated maize</p> </div> <div style="text-align: center;"> <table border="1" style="margin: auto;"> <tr> <td style="text-align: center;">2,2 A</td> <td style="text-align: center;">1,7 B</td> <td style="text-align: center;">1,8 B</td> </tr> </table> </div> <div style="text-align: center;"> <p>1,0 C</p> </div> </div> <p>Fig. 1. Ratio $^{14}\text{CO}_2/^{14}\text{C}_{\text{FE}}$ for soil samples collected from maize plants grown under controlled conditions, defoliated (50% of leaves removed) or not. Soil was sampled from distinct root zones and incubated 6 days with ^{14}C-glucose (3700 Bq, 0.01 $\mu\text{g C/g}$ soil). High $^{14}\text{CO}_2/^{14}\text{C}_{\text{FE}}$ ratio indicates a high microbial activity. Letters for control and defoliated plants are for means grouping by Newman-keuls test at $\alpha=5\%$.</p> <p>Greater microbial activity was evidenced for :</p> <ul style="list-style-type: none"> • Rhizosphere soil versus bulk soil • Rhizosphere of control plants versus that of defoliated plants • Apex+root hair zone versus older part of the root <p>Results suggest that rhizodeposition stimulates microbial activity. Rhizodeposition might be greater at root apices and might be reduced by defoliation.</p>				2,6 a	2,1 b	2,0 b	Apex+ root hair zone	Branches	Distal zone	2,2 A	1,7 B	1,8 B
2,6 a	2,1 b	2,0 b											
Apex+ root hair zone	Branches	Distal zone											
2,2 A	1,7 B	1,8 B											

ID	32_Paterson
Author	Paterson, Eric Macaulay Institute, Aberdeen, AB15 8QH, Scotland eric.paterson.macaulay.ac.uk; ++44 1224 498 200
Parameter	C-flow from plant roots
Soil type	Sand
Plant species	Broad range
System	Microcosm
Method	Biosensor reporting
Method description	Biosensor bacteria (<i>lux</i> -marked, with bioluminescence proportional to metabolic activity) can be utilised to report on root C-exudation from a wide range of plants amenable to growth in microcosm systems where roots develop in a 2-D chamber. The biosensor activity is digitally captured and quantified by use of a Charge Coupled Device (CCD) camera, image analysis software then allows temporal and spatial patterns of root exudation to be studied.
Do's, don'ts, potential limitations, untested possibilities	<p><i>Standardisation:</i> The key consideration in use of these biosensors is that their preparation and application is standardised, such that bioluminescence is a faithful and reproducible reporter of C-availability to the biosensor cells. A successful approach has been to culture the biosensor in rich microbial media to late exponential phase, harvest and wash cells and then incubate the harvested cells in a C-free media to deplete cellular C-reserves. The C-starved cells are then applied evenly across the surface of the 2-D root chamber (full details in Darwent et al., 2003). In a C-free matrix for root growth (e.g. muffle furnace sand) the C available to the biosensor is derived solely from root exudation. Therefore, the spatial distribution and intensity of bioluminescence, determined by CCD camera image capture, is proportional to exudation intensity from the root system. The spatial location of sites of exudation on the root system can be determined accurately through stacking of bright field (root system) and dark field (bioluminescence) images. The CCD camera can be mounted on either a standard camera lens or on a microscope allowing analysis of root exudation at a wide range of spatial scales.</p> <p><i>Treatment effects on biosensor response:</i> As bioluminescence is proportional to the metabolic activity of the biosensor, it is essential that in assessing effects of treatments on root C-flow the treatment does not directly affect the response of the biosensor. For example, assessment of effects of temperature or pH on root exudation would be confounded by direct effects of these factors on the metabolic activity of the biosensor. Such effects can be accounted for by determination of biosensor response to C-substrate standards under the relevant treatment conditions. A particular limitation to the use of biosensors for which bioluminescence is proportional to whole-cell metabolic activity is that a change in the quality of root C-flow may affect the activity of the biosensor. Thus, biosensor activity will be a function of both quantity and quality of C-flow. For this reason it is important to select a biosensor with a relevant broad substrate usage (e.g. rhizosphere competent strain) and to characterise its response to a range of typical exudate compounds (Yeomans et al., 1999). An alternative approach is to select biosensors for which expression of bioluminescence is specifically</p>

	<p>linked to a metabolic pathway for utilisation of particular exudate compounds (Jaeger et al., 1999). This would then give information on exudation intensity of particular compounds from specific regions of the root system.</p> <p><i>Application to real soils:</i> The approach is applicable to real soils in laboratory experiments, however, in this case biosensor activity will be affected by soil sources of C-substrates and competition with indigenous microorganisms. Therefore, in this instance biosensor bioluminescence reports on C-availability as opposed to directly reporting on root exudation. Since the biosensors are genetically modified organisms (GMOs) their use in field situations is prohibited and their use in laboratory systems is restricted by license and local GMO regulations.</p>
References	<p>Darwent, M.J.; Paterson, E.; McDonald, A.J.S.; Tomos, A.D. 2003. Biosensor reporting of root exudation from <i>Hordeum vulgare</i> in relation to shoot nitrate concentration. <i>Journal of Experimental Botany</i> 54: 325-334.</p> <p>Jaeger, C.H.I.; Lindow, S.E.; Miller, W.; Clark, E.; Firestone, M.K. 1999. Mapping of sugar and amino acid availability in soil around roots with bacterial sensors of sucrose and tryptophan. <i>Applied and Environmental Microbiology</i> 65: 2685-2690.</p> <p>Yeomans, C.V.; Porteous, F.; Paterson, E.; Meharg, A.A.; Killham, K. 1999. Assessment of lux-marked <i>Pseudomonas fluorescens</i> for reporting on organic compounds. <i>FEMS Microbiology Letters</i> 176: 79-83.</p>
Additional information	Detailed protocols are included in the references cited and further information may be requested from the author.

ID	32_Robin
Author	Robin, Christophe; Gross, Patrick; Lecomte, Alain UMR INRA-INPL(ENSAIA) "Agronomie et Environnement" BP 172 54505 Vandoeuvre les Nancy, France Christophe.Robin@ensaia.inpl-nancy.fr ; ++33 3 83 59 58 56
Parameter	¹⁴C assimilate allocation to rhizosphere compartments
Soil type	All kinds
Plant species	Various cultivated species including maize, ryegrass, <i>Medicago</i> sp.
System	field soil or artificially manipulated, in microcosms of different size
Method	¹⁴C-labelling of plant shoots, ¹²C-CO₂ and ¹⁴C-CO₂ monitoring
Method description	<p>Labelling of photoassimilates with isotopes (¹³C or ¹⁴C) is a useful method that allows to distinguish root-released C from C coming from soil organic matter. Conventional uses of the method lead to plant disturbance; no or poor regulation of CO₂ concentration of the atmosphere can affect photosynthesis and partitioning of C in the plant and rhizosphere compartments.</p> <p>Prior to labelling, shoots are separated from the belowground compartment (see 32_Warembourg_c). C-CO₂ and ¹⁴C specific activity of the atmosphere in the labelling chamber are regulated with a □ radiations scintillation detector (equipped with a plastic cell for gas) coupled with an infrared gas analyser. Other climatic parameters of the labelling chamber are regulated that allow to study net CO₂ assimilation and C partitioning in the plant-soil-microorganisms with minimized plant disturbances. The method is relevant for pulse and long term labelling of plant shoots.</p>
Do's, don'ts, potential limitations, untested possibilities	<p>The ¹⁴CO₂ is distributed either from a gas cylinder or generated by addition of NaH¹⁴CO₃ solution available commercially in 1 M lactic acid. The specific activity of the atmosphere is determined according to the following parameters: duration of labelling, number of plants within the chamber, activity to be detected in the lowest labelled compartment (usually ¹⁴C incorporated in the microbial biomass). During all the experiment, total CO₂ in the chamber is regulated at a constant concentration (see example given Fig. 1) by mass flow controllers. The most difficult aspect is to reach the required specific activity as soon as possible after the beginning of the labelling. This is achieved in 10 min. by injection at t=0 of a sufficient amount of ¹⁴CO₂ in the chamber (calculated according to the volume of the chamber and the required CO₂ concentration). The release of ¹⁴CO₂ is faster with lactic acid than with sulfuric acid. Then, regulations occurred according to the plant uptake. Plant shoots can be exposed to ¹⁴CO₂ either for short periods (minutes to hours) or longer ones (1 to many photoperiods). The belowground compartment is continuously flushed with air without CO₂, and CO₂ coming from the rhizosphere respiration is trapped in 1M NaOH (see 32_Warembourg_c).</p> <p>All data are recorded on computers and net CO₂ assimilation by plants can be calculated. Immediately after labelling and for the chase period, air from the chamber is forced to pass through a soda lime trap in order to decrease the ¹⁴C activity in the chamber, while ¹²CO₂ is continuously injected in the chamber to compensate trapping and plant uptake. After the chase period, plant and soil compartments are sampled and ¹⁴C and total C analysed (shoots, roots, adhering soil, bulk soil, microbial biomass, rhizosphere respiration).</p> <p>A part of the ¹⁴C respired by the shoots during the chase period can be re-</p>

	fixed during the chase period. To avoid this problem, the chamber has to be continuously flushed with renewed air or the ^{14}C continuously trapped in soda lime cartridge. The volume of the chamber has to be adapted to the plant size. Regulations and data acquisition are achieved by a software written in Visual basic. The same device can be used with $^{13}\text{CO}_2$ and has already been used for ^{15}N labelling of plant shoots with $^{15}\text{N-NH}_3$ (study of N rhizodeposition).
References	<p><i>Recent papers where this methodology has been used and briefly described :</i></p> <p>Bazot, S., Ulf, L., Blum, H., Nguyen, C., Robin, C. 2005. Effects of elevated CO_2 concentration on rhizodeposition from <i>Lolium perenne</i> grown on soil exposed to 9 years of CO_2 enrichment. Soil Biology Biochemistry, in press</p> <p>Henry, F.; Nguyen, C.; Paterson, E.; Robin, C. 2005. How does N availability alter rhizodeposition in <i>Lolium multiflorum</i> Lam. during vegetative growth? Plant and Soil 269: 181-191.</p> <p><i>Related paper describing generation of $^{14}\text{CO}_2$:</i></p> <p>Nguyen, C.; Todorovic, C.; Robin, C.; Christophe, A.; Guckert, A 1999. Continuous monitoring of rhizosphere respiration after labelling of plant shoots by $^{14}\text{CO}_2$. Plant and Soil 212: 191-201.</p>
Links	<p><i>Site of the laboratory with pictures on the methodology:</i></p> <p>http://www.ensaia.inpl-nancy.fr/lae/</p>

Additional information:

Fig. 1. Pulse labelling of plant shoots with $^{14}\text{CO}_2$, aiming to determine C partitioning in the plant and the rhizosphere compartment. In this example, ryegrass plants were labelled in an atmosphere enriched with CO_2 ($600 \mu\text{L L}^{-1}$) at a constant specific activity.

A : kinetics of the specific activity of the atmosphere fixed at $50 \text{ KBq mg}^{-1} \text{ C}$ during labelling.

B : kinetics of the CO_2 concentration in the chamber. The duration of labelling was 120 min. and the mean CO_2 concentration during labelling was $598 \pm 7.5 \text{ vpm}$. Arrows represent the beginning and the end of the labelling period.

^{14}C is detected with a scintillation detector Radiomatic A500 TR Packard Instruments (one acquisition every two min.) and CO_2 detected with an IRGA ADC

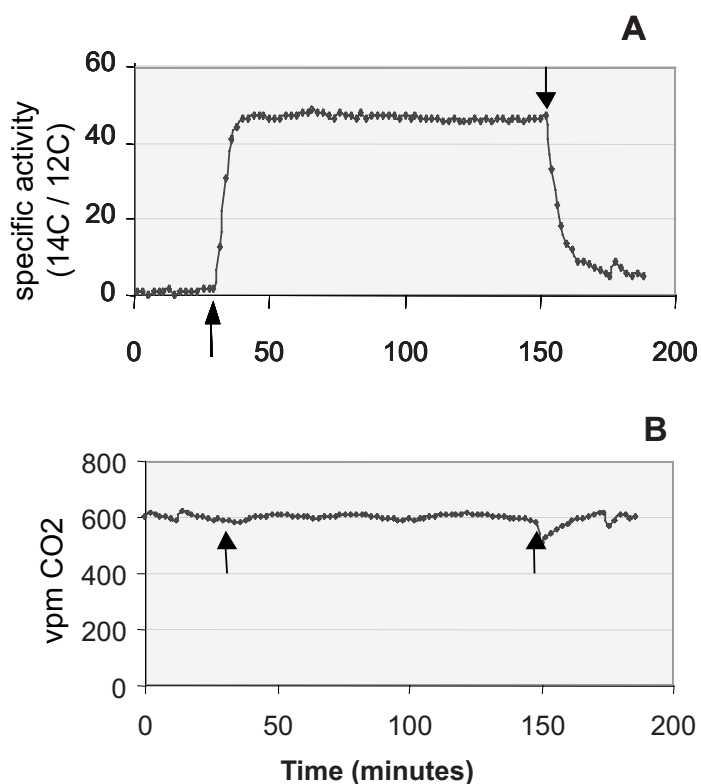

ID	32_Schweiger
Author	Schweiger, Peter Institute of Ecology & Conservation Biology, Vienna University, Althanstraße 14, A-1090 Vienna, Austria pschweig@pflaphy.pph.univie.ac.at; ++43 1 4277 54251
Parameter	Stable C and N isotopes in mycorrhizal research
Soil type	any
Plant species	mycorrhizal
System	None specified
Method	Isotope Ratio Mass Spectrometry (IRMS)
Method description	<p>A number of different methods have been used in mycorrhizal studies for the analysis of isotopic C and N composition of samples. Choice of method depends on the specific research aim.</p> <p>^{15}N and ^{13}C NMR (<i>Nuclear Magnetic Resonance</i>) have been applied to the analysis of biochemical pathways (Martin et al., 1986; Shachar-Hill et al., 1995). A prerequisite for this method is the application of ^{13}C- or ^{15}N-labelled substrates which are assimilated by the organisms in question. While this method also allows analyses to be performed <i>in vivo</i>, measurements are largely qualitative.</p> <p>For the quantification of labelled metabolites, samples are analysed by GC-MS (<i>Gas Chromatography interfaced with a Mass Spectrometer</i>, e.g. Johansen et al., 1996). For the analysis of the natural isotopic composition of samples, the use of IRMS is recommended (<i>Isotope Ratio Mass Spectrometry</i>). This method gives the C and N content of samples and their isotopic composition. This method has e.g. been used in studies that attempted to determine (i) the C source of mycorrhizal fungi (e.g. Högberg et al., 1999), (ii) the soil N pool tapped by mycorrhizal fungi (Hobbie et al., 1999), (iii) the influence of mycorrhizal fungal N uptake and transformations on isotopic signature of N transferred to the host plant (Emmertson et al., 2001) or (iv) interplant C transfer via mycorrhizal fungi (Fitter et al., 1998).</p>
Do's, don'ts, potential limitations, untested possibilities	N isotopic patterns of plant or mycorrhizal samples collected in the field have sometimes been taken as indicators of N source. Such interpretations have to be done with caution, since N uptake and metabolism by mycorrhizal fungi exert strong isotope fractionation.
References	<p>Emmertson, K.S.; Callaghan, T.V.; Jones, H.E.; Leake, J.R.; Michelsen, A.; Read, D.J. 2001. Assimilation and isotopic fractionation of nitrogen by mycorrhizal and nonmycorrhizal subarctic plants. <i>New Phytologist</i> 151: 513-524.</p> <p>Fitter, A.H.; Graves, J.D.; Watkins, N.K.; Robinson, D.; Scrimgeour, C. 1998. Carbon transfer between plants and its control in networks of arbuscular mycorrhizas. <i>Functional Ecology</i> 12: 406-412.</p> <p>Hobbie, E.A.; Macko, S.A.; Shugart, H.H. 1999. Insights into nitrogen and carbon dynamics of ectomycorrhizal and saprotrophic fungi from isotopic evidence. <i>Oecologia</i> 118: 353-360.</p>

	<p>Högberg, P.; Plamboeck, A.H.; Taylor, A.F.S.; Fransson, P.M.A. 1999. Natural ^{13}C abundance reveals trophic status of fungi and host-origin of carbon in mycorrhizal fungi in mixed forests. <i>Proceedings of the National Academy of Sciences USA</i> 96: 8534-8539.</p> <p>Johansen, A.; Finlay, R.D.; Olsson, P.A. 1996. Nitrogen metabolism of external hyphae of the arbuscular mycorrhizal fungus <i>Glomus intraradices</i>. <i>New Phytologist</i> 133: 705-712.</p> <p>Martin, F.; Stewart, G.R.; Genetet, I.; LeTacon, F. 1986. Assimilation of $^{15}\text{NH}_4$ by beech (<i>Fagus sylvatica</i> L.) ectomycorrhizas. <i>New Phytologist</i> 102: 85-94.</p> <p>Shachar-Hill, Y.; Pfeffer, P.E.; Douds, D.D.; Osman, S.F.; Doner, L.W.; Ratcliffe, R.G. 1995. Partitioning of intermediate carbon metabolism in VAM colonized leek. <i>Plant Physiology</i> 108: 7-15.</p>
Links	<p><i>A good introduction into mass spectrometry (also IRMS):</i> http://www.asms.org/whatisms/page_index.html</p> <p><i>An example for instrumentation and method sensitivity:</i> http://chemsrv0.pph.univie.ac.at/www/homepage_ww_neu/sil.htm</p>

ID	32_ Standing
Author	Standing, Dominic; Killham, Ken School of Biological Sciences, University of Aberdeen, Cruickshank Building, St Machar Drive, Aberdeen, AB24 3UU, Scotland, UK d.standing@abdn.ac.uk; ++44 1224 273254
Parameter	Carbon exudation from plant roots
Soil type	Sandy loams to clays
Plant species	Developed on <i>Triticum aestivum</i> cv. Scout (wheat)
System	Liquid batch culture, soil slurries, soil microcosms using field soils
Method	Carbon biosensing with <i>lux</i>-marked <i>Pseudomonas fluorescens</i>
Method description	<p>Plant-originated carbon is a key driver of soil microbial diversity but has proved to be difficult to quantify <i>in situ</i> at a scale relevant to primary consumers, i.e. soil micro-organisms. The most appropriate method of measuring this carbon flow is to monitor soil bacteria themselves and this can be done using <i>lux</i>-marked <i>Pseudomonas fluorescens</i> with the <i>lux</i> gene incorporated directly into the primary metabolism.</p> <p><i>Protocol for using Pseudomonas fluorescens 10586 pUCD607</i></p> <p>*** Kanamycin (Km) added at 50 µg ml⁻¹ ***</p> <p>Take a single colony from a LB+Km plate culture (grown from -80°C glycerol stocks and re-plated once - this replating from the original glycerol stock allows acclimated colonies to grow) and add to 10 ml LB+Km broth in a Universal vial. Place in a orbital shaker to grow overnight at 25 °C, 200 rpm. Take 1 ml of the stationary phase culture and add to 100 ml LB+Km broth in a 250 ml Erlenmeyer flask (put the flask + LB in the shaker several hours prior to inoculation so that it is at the same temperature and aeration as the overnight culture – reduces ‘lag’ effects. Add the Km at the time of inoculation.) Place in an orbital shaker (25°C, 200 rpm) until an optical density (OD₅₅₀) of 2 is reached. This should take about 18 hours or so. Harvest the culture by centrifugation at 5000 g for 5 minutes. Decant the supernatant. Re-suspend in an equal volume of carbon-free M9 (Difco) and centrifuge again.</p> <p>After this, place the washed culture (100 ml) in a 250 ml Erlenmeyer flask and add Km. Place on an orbital shaker (25°C, 200 rpm) for 2 hours to starve. After this period the culture is ready to be applied.</p> <p>Allow a 30 minute incubation period prior to recording the light output in a luminometer. We use a Turner Designs TD20/20 luminometer that accepts 35 mm Petri dishes. We add 1ml aliquots (c. 5 x 10⁹ cells g⁻¹ soil) and this appears to overcome any ‘quench’ effects. This has also been tried on heavy clay soils (40% clay fraction) at different percentages of sand and, although a ‘quench’ effect is noticeable, different levels of glucose-C can easily be assayed.</p> <p>Quantification of bacterial numbers can be achieved by appropriate plating. Quantification of C is achieved by running assays in parallel – one set of replicates of the root carbon along with replicated assays of known C (usually glucose) concentrations.</p>

<p>Do's, don'ts, potential limitations, untested possibilities</p>	<p><i>Limitations</i> At present, 1 ml aliquots of the starved culture give good reproducible results at a fairly coarse resolution. It would be useful to scale this down several orders of magnitude (see below). This carbon reporter responds rapidly to readily assimilable C. While these C forms comprise much of the exudate of young plants (Yeomans, <i>et al.</i>, 1999), we have not yet developed a system for interrogating complex C exudates.</p> <p><i>Methodological issues</i> Very few – if good, clean colonies are used for initial inocula then this protocol appears to be robust.</p> <p><i>Future potential</i> This protocol can likely be scaled down so that spatial interrogation of C around lateral root buds, for example, can be carried out. Ensuring accurate and reproducible bacterial numbers at very low volumes remains a methodological problem, but one that should be straightforward to overcome. This protocol has proved useful for gaining data for incorporation into rhizosphere models.</p>
<p>References</p>	<p>Standing, D.B.; Rangel Castro, J.I.; Prosser, J.I.; Meharg, A.A.; Killham, K. Rhizosphere carbon flow - a driver of soil biodiversity? 2005. In: Bardgett, R.; Usher, M.; Hopkins, D. (eds.). Biological Diversity and Function in Soils. Cambridge University Press, Cambridge, UK.</p> <p>Standing, D.B.; Meharg, A.A.; Killham, K. 2003. A tripartite microbial reporter gene-system for real-time assays of soil nutrient status. FEMS Microbiology Letters 220: 35-39.</p> <p>Yeomans, C.V.; Porteous, F.; Paterson, E.; Meharg, A.A.; Killham, K. 1999. Assessment of lux-marked <i>Pseudomonas fluorescens</i> for reporting on organic carbon compounds. FEMS Microbiology Letters 179: 79-83.</p>

ID	32_Warembourg_a
Author	Warembourg, Fernand Robert (Franck) CEFE, CNRS, 1919, Route de Mende, 34293 Montpellier Cedex 5, France warembourg.eyde@neuf.fr ; ++33 4 67 61 32 94
Parameter	Rhizosphere C partitioning using ¹⁴C
Soil type	Artificial substrate, carbonate free soils
Plant species	Any, may be limited by the size of labelling chamber
System	Pots, monoliths in greenhouses and/or laboratory
Method	Short term labelling of plants with ¹⁴CO₂
Method description	<p>Plants have to be enclosed in an airtight labelling chamber generally adapted to their size. Minimum equipment consists of a ¹⁴CO₂ generating unit and a CO₂ regulating analyser but a great variety of sophistication exists in order to maintain and or control plant environment.</p> <p><i>Without regulation of the CO₂ specific activity</i> inside the labelling chamber. CO₂ concentration is however carefully regulated in order to avoid upsetting photosynthesis. This is the procedure that is commonly used in pulse labelling. In this case, the CO₂ concentration inside the chamber (360 ppm or more) is monitored using an Infra Red Gas Analyser (IRGA). The IRGA is connected to a ¹⁴CO₂ source (sodium carbonate) by a solenoid valve, which allows the carbonate solution to drop into sulphuric acid and release ¹⁴CO₂. Exposure of plants to ¹⁴CO₂ may vary from one hour to one photoperiod and the level of radioactivity calculated accordingly.</p> <p><i>With regulation of both CO₂ concentration and specific activity:</i> This is required for a detailed study of the specific activity of respired CO₂ in the rhizosphere. The CO₂ concentration inside the chamber (360 ppm) is monitored using an Infra Red Gas Analyser (IRGA). The IRGA is connected to a CO₂ source (sodium carbonate) by a solenoid valve, which allows the carbonate solution to drop into sulphuric acid and release CO₂. This CO₂ is labelled with ¹⁴C at a predetermined specific activity. This is done using a differential ionisation chamber (CEA Cadarache, France) connected to a ¹⁴C source (commercial solution of ¹⁴C sodium carbonate with low C content) by a second solenoid valve. This valve controls the addition of the labelled solution to the flask containing sulphuric acid. During the night, a bypass circuit operated by a timer is used. It allows the absorption on soda lime of excess CO₂ (above the fixed 350 ppm concentration) coming from plant respiration. This system is controlled by the IRGA. The dual control of CO₂ and radioactivity maintains a constant specific activity throughout the labelling period which can last from one day to several months.</p>
Do's, don'ts, potential limitations, untested possibilities	<ul style="list-style-type: none"> • The use of radioactive isotopes requires specific equipment and laboratory conditions and is generally ruled by strict safety regulations that may vary from one country to another. • When the ¹⁴CO₂ source is not in gas form (in already prepared pressure tanks), and is generated from commercial solutions of e.g. sodium carbonate, appropriate dilution with unlabelled C has to be prepared in order to meet the specific requirements (volume of chamber, CO₂ concentration, specific activity, length of exposure). • Nowadays a differential ionisation chamber can be difficult to find. The will be replaced by online scintillation counters as described by 32_Robin.
References	<p><i>Description of labelling chambers, equipments, procedures and calculations :</i> Warembourg, F.R.; Kummerov, J. 1991. Photosynthesis/ translocation studies in terrestrial ecosystems. In : Coleman, D.C.; Fry, B. (eds.) Carbon Isotope Techniques. Academic Press. Inc., pp. 11-37.</p> <p><i>Example of application:</i> Warembourg, F.R.; Estelrich, H.D. 2001. Plant phenology and soil fertility effects on below-ground carbon allocation for an annual (<i>Bromus madritensis</i>) and a perennial (<i>Bromus erectus</i>) grass species. Soil Biol. Biochem. 33: 1291-1303.</p>

ID	32_Warembourg_b
Author	Warembourg, Fernand Robert (Franck) CEFE, CNRS, 1919, Route de Mende, 34293 Montpellier Cedex 5, France warembourg.eyde@neuf.fr ; ++33 4 67 61 32 94
Parameter	N₂ fixation using ¹⁵N₂
Soil type	Artificial substrate, Soil
Plant species	N ₂ fixing plant-microbial associations
System	Pots in greenhouses and/or laboratory
Method	Exposure of plant roots to ¹⁵N₂
Method description	Labelling of soil atmosphere with ¹⁵ N ₂ is more convenient than replacing the entire atmosphere with artificial mixtures. Separation of below-ground atmosphere is carefully done using the same procedure as for respiration measurement (see 32_Warembourg_c). Plant containers are then connected to a closed circuit system consisting of a peristaltic pump, an expansion bag, a CO ₂ trap and an O ₂ regulating device. The amount of ¹⁵ N ₂ enriched gas calculated to meet the requirement of the experiment is then introduced into the system. This is done either by injection in each plant container using a syringe or supplied from a gas ampoule directly inserted into the system and emptied by replacing the gas by water. The pump then circulates the gas into each container and out in the common circuit to thoroughly mix the inside atmosphere. Increase of volume due to ¹⁵ N ₂ injection is compensated for by the expansion bag. The exposure period is often set to 24h.
Do's, don'ts, potential limitations, untested possibilities	Since calculation of N ₂ fixation is based on the ¹⁵ N concentration in the soil atmosphere, ¹⁵ N enrichment of the experimental atmosphere has to be determined on soil air samples taken at regular intervals throughout the exposure period. These samples taken by disposable syringes and temporarily stored into evacuated tubes ought to be analysed right away using a mass or an emission spectrometer. To prevent leaks is the more tricky challenge when using ¹⁵ N ₂ .
References	<i>Description of methods, equipments, calculation and procedures:</i> Warembourg, F.R.; Montange, D.; Bardin, R. 1982. The simultaneous use of ¹⁴ CO ₂ and ¹⁵ N ₂ labelling techniques to study the carbon and nitrogen economy of legumes grown under natural conditions. <i>Physiol. Plant.</i> 56: 46-55. Warembourg, F.R. 1992. Nitrogen fixation in soil and plant systems. In: Knowles, R.; Blackburn, M. (eds.) <i>Nitrogen Isotope Techniques</i> , Academic Press. Inc, pp. 127-156.

ID	32_Warembourg_c
Author	Warembourg, Fernand Robert (Franck) CEFE, CNRS, 1919, Route de Mende, 34293 Montpellier Cedex 5, France warembourg.eyde@neuf.fr; ++33 4 67 61 32 94
Parameter	Rhizosphere C partitioning using ¹⁴C: Rhizosphere respiration
Soil type	Artificial substrate, soil
Plant species	Any plant
System	Pots in greenhouses and/or laboratory
Method	Separation of above and below-ground atmospheres and collection of CO₂
Method description	<p><i>Separation of above and below-ground atmospheres:</i> Plants (one or two) are grown in plain culture pots. Prior to labelling, the pots are transferred into plastic containers with a fitting cover. This cover is cut in half and the two halves present holes (one or two) adapted to fit the base of the plants. Glass wool is inserted in the holes and RTV silicone rubber (Dow Corning) poured around the plant stem and over the cut. Along the side of the pots, inlet and outlet ports are used for aeration and collection of CO₂. A third hole made in the cover and plugged with a rubber septum is used for watering which is done using a disposable syringe. Containers are immersed in water to check for leaks, the various openings being closed except one that is used to raise the pressure by slow introduction of air. This is done by blowing gently. Occurrence of leaks is indicated by bubbles.</p> <p><i>Collection of CO₂:</i> During and after exposure of plant to ¹⁴C, CO₂ is collected from the root containers and adsorbed in NaOH solutions that are replaced periodically (according to the frequency of information needed). The equipment used consists of a multichannel peristaltic pump (one channel per pot) which circulates air inside the plant containers and towards a CO₂ collector consisting of an automatic sampler holding the NaOH tubes. Prior to entering the container, air is freed of CO₂ by passing through soda-lime. Aliquots of 1ml are assayed for ¹⁴C, the remaining of the NaOH solutions is titrated for C content. This enables determination of CO₂ specific activity.</p>
Do's, don'ts, potential limitations, untested possibilities	<ul style="list-style-type: none"> • Physiological moulding material (Terostat, Teroson, Heidelberg) is more readily applied around the plant stems than RTV silicone rubber; however the latter makes a better leak proof seal especially with grasses and rosette plants. • To prevent carbonation of NaOH in the tubes of the automatic sampler, liquid mineral oil on top of the solution makes a perfect seal. If an automatic sampler is not available, standard tubes provided with a plunger can be used for CO₂ collection. They have to be changed manually. Care should be taken that the NaOH normality allows complete adsorption of respired CO₂ between two samplings. It has been demonstrated that no more than 1/3 to 1/2 of the NaOH adsorption capacity is used for complete collection of CO₂.
References	<p><i>Description of methods :</i> Warembourg, F.R.; Kummerov, J. 1991. Photosynthesis/ translocation studies in terrestrial ecosystems. In : Coleman, D.C.; Fry, B. (eds.) Carbon Isotope Techniques, Academic Press. Inc., pp. 11-37.</p> <p><i>Example of application :</i> Warembourg, F.R.; Estelrich, H.D. 2001. Plant phenology and soil fertility effects on below-ground carbon allocation for an annual (<i>Bromus madritensis</i>) and a perennial (<i>Bromus erectus</i>) grass species. <i>Soil Biology and Biochemistry</i> 33: 1291-1303.</p>

ID	33_Ciucani
Author	Ciucani, G. ¹⁾ ; Sacchi, G.A. ²⁾ ¹⁾ SIPCAM S.p.A.- Via Vittorio Veneto 81. Salerano sul Lambro (Lodi), Italy gciucani@sipcam.it; ++39 0371 596 229 ²⁾ Università di Milano. Facoltà d'agraria. DiProVe. Via Celoria 2, 20100 Milano, Italy; gianattilio.sacchi@unimi.it; ++39 02 5031 6525
Parameter	Xenobiotics root uptake and transport
Plant species	Soybean
System	Laboratory test with hydroponically grown plants
Method	Pressure Chamber Technique (PCT)
Method description	Plant roots, grown in hydroponic cultivation, are bathed in a solution containing the test compound. Hydrostatic pressure (0.3-0.4 MPa), generated by compressed air containing 7% oxygen, is applied to the roots and held constant. The solution containing the roots is constantly aerated by an air pump. After a few minutes a constant xylem sap flow (about 0.1 ml min ⁻¹) is obtained. Concentrations in external solution and in xylem sap are directly measured by HPLC.
Do's, don'ts, potential limitations, untested possibilities	<ul style="list-style-type: none"> • If the aim of applying the pressure chamber technique is to describe the translocation of very lipophilic or dissociating compounds (e.g., many pesticides) and to extrapolate to field situations, the results are of limited value. • On the contrary PCT might be very useful to identify early parameters or conditions able to influence uptake and translocation into root xylem of different compounds without using radiolabelled tracer. • PTC can be used for many plant physiological investigations.
References	Hsu, F.C.; Marxmiller, R.L.; Yang, A.Y.S. 1990. Study of root uptake and xylem translocation of Cinmethylin and related compounds in detopped soybean roots using a pressure chamber technique. <i>Plant Physiol.</i> 93:1573-1578. Sicbaldi, F.; Sacchi, G.A.; Trevisan, M.; Del Re, A.A.M. 1997. Root uptake and xylem translocation of pesticides from different chemical classes. <i>Pestic. Sci.</i> 50:111-119. Ciucani, G.; Trevisan, M.; Sacchi, G.A.; Trapp, S.A.J. 2002. Measurement of Xylem Translocation of Weak Electrolytes with the Pressure Chamber Technique. <i>Pest. Manag. Sci.</i> 58:467-473.
Additional information	More detailed information for use of the apparatus is available upon request from the authors.

ID	33_DOrazio_a
Author	D'Orazio, Valeria; Senesi, Nicola Università di Bari, Facoltà di Agraria, DiBCA, Via G. Amendola 165/A, 70126, Bari, Italy dorazio@agr.uniba.it; ++39 0805 442205
Parameter	Indigenous organic free radicals and complexed transition metal ions in humic substances (HS) in rhizospheric and adjacent soil
Soil type	Any
Plant species	Herbaceous: wheat, spring rapeseed, faba bean, tomato, artichoke Woody: apple, olive, vine
System	Field
Method	Electron spin (or paramagnetic) resonance (ESR or EPR) Spectroscopy
Method description	<i>Sample preparation and fractionation:</i> Humic acids (HAs) are isolated according to conventional procedures based on sodium hydroxide-sodium pyrosphosphate extraction, precipitation by HCl to pH ~ 2, mild purification by successive NaOH-dissolution and HCl precipitation steps, water washing, dialysis, and final freeze-drying. <i>ESR spectra:</i> ESR spectra are obtained at RT or liquid N ₂ temperature on solid or water-dissolved HS samples in quartz ESR tubes, using instrumental conditions described in the literature.
Do's, don'ts, potential limitations, untested possibilities	<ul style="list-style-type: none"> Free radicals represent a most peculiar reactive moiety in HS macromolecules. Their concentration depends on the nature and origin of the sample, as well as on several parameters such as pH, redox conditions, etc. ESR spectra can also detect the presence of paramagnetic transition metal ions in HS, and provide information on their oxidation state, metal binding site(s), ligand type, metal coordination, and degree of stability of metal complexes. The contribution of HS fractions to the dynamics of metals in the rhizosphere compartment is not yet tested.
References	Senesi, N. 1992. Metal-humic substance complexes in the environment. Molecular and mechanistic aspects by multiple spectroscopic approach. In: Adriano, D.C. (ed.) Biogeochemistry of Trace Metals, CRC Press, Boca Raton, USA, pp. 425-491. Senesi, N. 1996. Electron spin (or paramagnetic) resonance spectroscopy. In: Sparks, D.L. (ed.) Methods of Soil Analysis: Chemical Methods. ASA-CSSA-SSSA, Publ. Madison (USA), pp. 323-356.

ID	33_DOrazio_b
Author	D'Orazio, Valeria; Senesi, Nicola Università di Bari, Facoltà di Agraria, DiBCA, Via G. Amendola 165/A, 70126, Bari, Italy dorazio@agr.uniba.it; ++39 0805 442205
Parameter	Molecular structure of humic substances (HS) in rhizospheric and adjacent soil
Soil type	Any
Plant species	Herbaceous: wheat, spring rapeseed, faba bean, tomato, artichoke. Woody: apple, olive, vine
System	Field
Method	Fourier Transform Infrared Spectroscopy (FT-IR)
Method description	<i>Sample preparation and fractionation:</i> Humic acids (HAs) are isolated according to conventional procedures based on sodium hydroxyde-sodium pyrosphosphate extraction, precipitation by HCl to pH ~ 2, mild purification by successive NaOH-dissolution and HCl precipitation steps, water washing, dialysis, and final freeze-drying. <i>FT IR spectra:</i> FT IR spectra are obtained in the range 4000-400 cm ⁻¹ on pellets prepared by uniformly mixing and pressing under reduced pressure 1 mg of HA and 400 mg of dried KBr, spectrometry grade.
Do's, don'ts, potential limitations, untested possibilities	Molecular structures of HAs isolated from the rhizosphere soil compartment can be compared to those of HAs isolated from the corresponding adjacent bulk soil (for methods to differentiate bulk and rhizosphere soil see chapter 1.3.)
References	Stevenson, F.J. 1994. Humus Chemistry: Genesis, Composition, Reactions; 2 nd ed.; John Wiley & Sons, New York. Senesi, N.; Loffredo, E. 1999. The Chemistry of Soil Organic Matter. In: Sparks, D.L. (ed.) Soil Physical Chemistry, 2 nd Edit. CRC Press, Boca Raton, pp. 239-370. Senesi, N; D'Orazio, V.; Ricca, G. 2003. Humic Acids in the First Generation of EUROSOLS. Geoderma 116: 325-334.

ID	33_Loffredo_a
Author	Loffredo, Elisabetta; Senesi, Nicola Dip. Biologia e Chimica Agroforestale ed Ambientale, Università di Bari, Bari, Italy loffredo@agr.uniba.it; ++39 0805 442282
Parameter	Sorption of the highly persistent organochlorine insecticide chlordane to soils and soil humic acids
Soil type	Any
System	Laboratory experiments
Method	Batch equilibrium method and GC analysis
Method description	<p><i>Equilibration:</i> Aliquots of 30 mL of 7.5% (v/v) ethanol/water solution of a mixture of <i>trans</i>- and <i>cis</i>-chlordane, at concentrations ranging from 0.01 to 1 mg L⁻¹ for each isomer, are added to 1 g of soil or 5 mg of humic acid (HA), in glass flasks. Equilibration is achieved by shaking the mixtures mechanically for 20 h at 20°C. Soil or HA suspensions are then centrifuged at 17,400 g for 15 min, and the supernatant solutions are removed, filtered and stored in stoppered glass vials in the dark until analysis.</p> <p><i>Extraction:</i> Chlordane (<i>trans</i>- and <i>cis</i>-chlordane mixture) are extracted from adequate aliquots of the supernatant solution of each sample using solid phase extraction (SPE) with Supelclean™ Envi™-18, 3 mL (0.5 g) cartridges, and the Merck LiChrolut® Extraction Unit. The extraction procedure consists of i) conditioning the cartridge by using 3 mL of methanol and then 2 mL of 5% (v/v) methanol in H₂O; ii) addition to the cartridge of 2 mL supernatant solution at a constant flow rate < 5 mL min⁻¹ using a vacuum system; iii) drying the cartridge in vacuum for some min; iv) dropwise elution of the adsorbed product with 2 x 1 mL of <i>n</i>-hexane/acetone (9:1) solution. During the extraction, <i>cis</i>- and <i>trans</i>-chlordane were also concentrated adequately in the solution, depending on their initial concentration, in order to obtain a better gas chromatographic detectability. Aliquots of 2 mL of 7.5% (v/v) ethanol/water solution of a mixture of <i>trans</i>- and <i>cis</i>-chlordane, at concentrations 0.01, 0.05, 0.1 and 0.2 mg L⁻¹ are extracted using the procedure described above, and used as standard solutions for the quantification of <i>cis</i>- and <i>trans</i>-chlordane.</p> <p><i>Analysis:</i> Chlordane analyses are performed with a Fisons HRGC Mega 2 series Gas Chromatograph equipped with an electron capture detector (ECD) containing a Ni⁶³ beta-emitting radioactive source, and operated in the constant current mode to increase the linearity of ECD response. A GC Mega SE-52 column, 30 m length x 0.53 mm inside diameter, is used. The operating conditions are the following: oven temperature program, from 200°C (1 min) to 230°C (held for 3 min), at 5°C min⁻¹; injector and detector temperatures, 260°C and 310°C, respectively; flow rate for carrier gas, helium, about 8 mL min⁻¹, and for make-up gas, nitrogen, about 42 mL min⁻¹. Split injection technique was adopted by injecting a sample volume of 1 µL using <i>n</i>-hexane/acetone 9:1 as solvent. Retention times for <i>trans</i>- and <i>cis</i>-chlordane are different enough to allow an adequate distinction between the two products.</p>

	<p>Nine calibration solutions of <i>cis</i>- and <i>trans</i>-chlordane at concentrations ranging from 0.01 to 10 mg L⁻¹ in <i>n</i>-hexane/acetone 9:1 (v/v) have been used to test detector response that is linear between 0.01 and 0.2 mg L⁻¹ for both isomers with a correlation coefficient of the calibration curve close to 1 for both analytes.</p> <p><i>Calculations:</i> The amounts of <i>cis</i>- and <i>trans</i>-chlordane adsorbed are calculated as the difference between the initial and the equilibrium concentration of the product in solution. All experiments are replicated at least three times. Experimental adsorption data for <i>cis</i>- and <i>trans</i>-chlordane onto soil or HA are fitted to both the linear model, nonlinear Freundlich equation, $x/m = KC^{1/n}$, and Langmuir equation, $x/m = (KCb)/(1+KC)$, where x/m is the amount of <i>cis</i>- or <i>trans</i>-chlordane adsorbed in $\mu\text{g g}^{-1}$, and C is the equilibrium solution concentration of <i>cis</i>- or <i>trans</i>-chlordane in $\mu\text{g mL}^{-1}$. The constant K is a measure of the adsorption capacity of the substrate, the constant $1/n$ indicates the degree of nonlinearity between solution concentration and amount adsorbed, and b represents the Langmuir adsorption maximum.</p>
Do's, don'ts, potential limitations, untested possibilities	This procedure can be applied to other organochlorine pesticides.
References	<p>Loffredo, E.; Senesi, N.; D'Orazio, V. 1997. Chlordane adsorption onto soils and pig slurry. <i>Int. J. Environ. Analytical Chemistry</i> 66: 163-174.</p> <p>Loffredo, E.; D'Orazio, V.; Brunetti, G.; Senesi, N. 1999. Adsorption of chlordane onto humic acids from soils and pig slurry. <i>Organic Geochemistry</i> 30: 443-451.</p>
Additional information	More detailed informations are available from the authors.

ID	33_Loffredo_b
Author	Loffredo, Elisabetta; Senesi, Nicola Dip. Biologia e Chimica Agroforestale ed Ambientale, Università di Bari, Bari, Italy; loffredo@agr.uniba.it; ++39 0805 442282
Parameter	Adsorption/desorption of endocrine disruptor compounds (EDC) to / from soils and soil humic acids
Soil type	Any
System	Laboratory experiments
Method	Batch equilibrium method and HPLC analysis
Method description	<p><i>Adsorption experiments:</i> Soil: Aliquots of 5 g of soil are added to 20 mL of aqueous solutions of bisphenol A (BPA) at concentrations of 1, 2, 4, 8, 12, 20, and 40 mg L⁻¹ or 20% (v/v) ethanol/water solutions of 17-alpha-ethynilestradiol (EED) or 17-beta-estradiol (17ED) at concentrations of 1, 2, 4, 8, 12, and 20 mg L⁻¹. For octylphenol (OP), aliquots of 2 g of soil are added to 15 mL of 10% (v/v) ethanol/water solutions of OP at concentrations of 0.1, 0.2, 0.5, 1, 2, 4, and 5 mg L⁻¹.</p> <p><i>Humic acid:</i> Aliquots of 10 mg humic acid (HA) are added to 5 mL of aqueous solutions of BPA at concentrations of 1, 2, 4, 8, 12, 20, and 40 mg L⁻¹, or with 15 mL of 5% (v/v) ethanol/water solutions of EED or 17-beta-estradiol (17ED) at concentrations of 0.1, 0.2, 0.5, 1, 2, and 5 mg L⁻¹. For OP, aliquots of 10 mg of HA are added with 5 mL of 10% (v/v) ethanol/water solutions of OP at concentrations of 0.1, 0.2, 0.5, 1, 2, 4, and 5 mg L⁻¹.</p> <p>For any substrate, equilibration is achieved by mechanical shaking of mixtures for 24 h at 20 ± 2°C in the dark. Suspensions are centrifuged at 17,400 g for 15 min and the supernatant solutions are removed and stored in stoppered glass vials in the dark. The equilibrium concentrations of each EDC is measured by HPLC using a thermo Separation Products Liquid Chromatograph equipped with 15-cm Merck LiChrospher® 60 RP-Select B column for BPA, EED and 17ED or Supelcosil™ LC-18 column for OP. The mobile phase is a solution of acetonitrile/water at a ratio of 40/60 (v/v) for BPA, 50/50 (v/v) for EED and 17ED, and 75/25 (v/v) for OP. Ultraviolet (UV) detection at 280 nm is used for BPA, and for the other EDC a fluorescence detector is used operating at excitation and emission wavelengths respectively of 280 and 306 nm for EED and 17ED, and of 230 nm and 310 nm for OP.</p> <p>In the case of EED and 17ED, before HPLC analysis, 2-mL aliquots of the supernatant solutions are subjected to solid phase extraction (SPE) using Merk LiChrolut® Extraction Unit and Merk LiChrolut® EN cartridges (200 mg). The cartridge is previously conditioned with 2 mL of methanol and then with 2 mL of 5% (v/v) methanol in water. After the addition of sample solution, the cartridge is dried under vacuum, and the residue eluted twice with 1 mL acetone. Eluate is then analyzed by HPLC.</p> <p>The amounts of EDC adsorbed are calculated as the difference between the initial and the equilibrium concentration of EDC in solution.</p> <p><i>Desorption experiments:</i> Desorption of EDCs from soil or HA is obtained by sequential release of the compound immediately after its adsorption by centrifuging the mixtures,</p>

	<p>carefully removing the equilibrium solution, and replacing it with the same volume of bidistilled water or the appropriate ethanol/water solution (see adsorption). After each desorption step, the amount of dissolved EDC present in the equilibrium solution that remains entrapped in the substrate is calculated and subtracted from the total amount of EDC measured in the supernatant solution. The concentration of EDC in the supernatant solutions are measured by HPLC under the same conditions used for adsorption experiments. The suspensions are then shaken mechanically for 24 h to obtain a new equilibrium condition, and centrifuged. The desorption procedure is repeated until the concentration of EDC in the supernatant solution falls below the lower limit of the amount detectable in the conditions used (see adsorption).</p> <p>All adsorption and desorption experiments are replicated at least three times. Experimental data for adsorption and desorption of EDC onto soil and HA are then fitted to the Freundlich equation in order to calculate the Freundlich adsorption and desorption parameters.</p>
References	<p>Loffredo, E.; Pezzuto, M.; Senesi, N. 2000. Adsorption-desorption of environmental endocrine disruptors onto humic acids from soils and urban sludges. In: Ghabbour, E.A.; Davies, G. (eds.). Humic Substances: Versatile Components of Plants, Soils and Water. RSC Press, Cambridge, UK, pp. 191-203.</p> <p>Loffredo, E.; Senesi, N. 2002. Sorption and release of endocrine disruptor compounds onto/from surface and deep horizons of two sandy soils. In: Violante, A.; Huang, P.M.; Bollag, J.-M.; Gianfreda, L. (eds.) Soil Mineral-Organic Matter-Microorganism Interactions and Ecosystem Health. Vol. 28A: Dynamics, Mobility and Transformation of Pollutants and Nutrients. Developments in Soil Sciences Series. Elsevier Sci., Amsterdam, pp. 143-159.</p>
Additional information	<p>More detailed informations are available from the authors.</p>

ID	33_Loffredo_c
Author	Loffredo, Elisabetta; Senesi, Nicola Dip. Biologia e Chimica Agroforestale ed Ambientale, Università di Bari, Bari, Italy loffredo@agr.uniba.it; ++39 0805 442282
Parameter	Adsorption of the hydrophobic herbicide triallate to soils and soil humic acids
Soil type	Any
System	Laboratory experiments
Method	Batch equilibrium method and HPLC analysis
Method description	<p><i>Equilibration:</i> Aliquots of 2 g of soil or 5 mg humic acid (HA) are added to, respectively, 20 mL or 30 mL of aqueous solutions of triallate at concentrations ranging from 0.1 to 4 mg L⁻¹ (higher limit of water solubility of the product). Equilibration is achieved by shaking the mixtures mechanically for 22 h at 20 ± 2°C in the dark. Soil or HA suspensions are then centrifuged at 17,400 g for 15 min, and the supernatant solutions are removed, filtered, and stored in stoppered glass vials in the dark until analysis</p> <p><i>Analysis:</i> The equilibrium concentration of triallate in the supernatant solution is measured by high performance liquid chromatography (HPLC), using a Perkin Elmer Model Series 2 Liquid Chromatograph, equipped with 15-cm Supelco LC-8 column. The mobile phase is an isocratic solution of acetonitrile/water at a ratio of 75/25 (v/v) for soil samples, and 65/35 (v/v) for HA samples. Triallate is measured by UV detection at 220 nm.</p> <p><i>Calculations:</i> The amount of triallate adsorbed onto soil or HA at any equilibrium concentration is calculated as the difference between the initial and the equilibrium concentration of the product in solution. All adsorption experiments are replicated at least three times. Experimental data obtained for soil or HA are finally fitted to a linear model, nonlinear Freundlich equation, and Langmuir equation in order to estimate the best model interpreting experimental data, and calculate the adsorption capacity of both soil and HA for triallate.</p>
Do's, don'ts, potential limitations, untested possibilities	This procedure can be applicable to other pesticides
References	Loffredo, E.; D'Orazio, V.; Senesi, N. 1997. Adsorption of triallate onto soils and pig slurry. J. Environ. Sci. Health Part B, B32: 25-36. D'Orazio, V.; Loffredo, E.; Brunetti, G.; Senesi, N. 1999. Triallate adsorption onto humic acids of different origin and nature. Chemosphere 39: 183-198.
Additional information	More detailed informations are available from the authors.

ID	33_Luster
Author	Luster, Jörg; Blaser, Peter Swiss Federal Institute for Forest, Snow, and Landscape Research WSL, CH-8903 Birmensdorf, Switzerland joerg.luster@wsl.ch; ++41 44 739 22 95
Parameter	Phenolics and their metal complexation ability in soil solution, leaf litter leachates and extractable soil organic matter (SOM)
Soil type	Acid Forest Soils, Vertisols
System	Field
Method	Total Luminescence Spectroscopy
Method description	<p><i>Sample preparation and fractionation:</i> Extracts with 0.5 M NaOH using a solid to extractant ratio of 1:20 are performed over night. Extracts are recovered by centrifugation (--> extractable SOM). Fulvic (FA) and humic acid (HA) fractionation is performed by acidification of the extracts to pH 1 (soluble: FA; insoluble HA; the HA fraction is redissolved in NaOH). Size fractionation is done by dialysis with a molecular weight cut-off of 14'000.</p> <p>Soil solution (sampled by zero-tension or tension lysimetry, see 13_Graf-Pannatier) and aqueous leaf litter leachates are membrane filtrated (0.45 µm).</p> <p>For fluorescence spectroscopy, all samples are diluted or concentrated to a given concentration of dissolved organic carbon and adjusted to a given pH.</p> <p><i>Total Luminescence Spectra (TLS):</i> A set of synchronous scan fluorescence spectra with increasing delta values (difference between excitation and emission wavelength) is recorded. Based on these spectra, a surface spectrum is calculated by means of a computer program for presentation graphics (--> TLS).</p> <p><i>Data analysis and interpretation:</i> Qualitatively, signals can be observed for 2 different groups of simple phenolic structures and 1 group of more highly conjugated aromatic structures. The complexation of Al by one of the two groups of simple phenolic structures is clearly indicated by a shift of the corresponding signal. Stability constants and binding capacities for complexes of Al and Cu with different binding sites of dissolved organic matter (DOM) can be determined by analysing quantitatively the change at several given excitation/emission wavelength pairs upon metal addition (--> Multi-wavelength molecular fluorescence spectrometry).</p>
Do's, don'ts, potential limitations, untested possibilities	<p><i>Qualitative comparison of different SOM by TLS</i> Adjusting sample solutions to an equal pH and C concentration facilitates comparisons, e.g. of the soil solution at different depths in a soil. Recommended concentrations of dissolved organic carbon are 5 to 10 mg/L. For alkaline soil extracts, their molecular weight fractions, and HA, the pH should be not below 7.</p> <p><i>Correction for TLS</i> If TLS are to be compared to fluorescence spectra recorded under different conditions, two types of correction must be made. First, blanc TLS have to be</p>

	<p>subtracted. In addition, corrections for inner filter effects are necessary based on the separately recorded molecular absorption spectra.</p> <p><i>Multi-wavelength molecular fluorescence spectrometry</i> So far, there is only one application to the Al and Cu complexes of juniper litter leachates.</p>
References	<p><i>General description of fluorescence spectroscopy, correction for inner filter effects:</i> Lakowicz, J.R. 1983. Principles of Fluorescence Spectroscopy. Plenum Press, New York, 496pp.</p> <p><i>Description of TLS, molecular assignments of signals, application to DOM in surface waters</i> Blaser, P.; Heim, A.; Luster, J. 1999. Total luminescence spectroscopy of NOM-typing samples and their aluminium complexes. Environ. Int. 25: 285-293.</p> <p><i>Application of TLS to extractable SOM:</i> Gehring, A.U.; Guggenberger, G.; Zech, W.; Luster, J. 1997. Combined Magnetic, Spectroscopic and Analytical-Chemical Approach to Infer Genetic Information for a Vertisol. Soil Sci. Soc. Am. J. 61: 78-85.</p> <p>Szombathová, N.; Luster, J.; Zaujec, A.; Blaser, P. 2001. Fluorescence Spectra of Soil Humic and Fulvic Acids Isolated from Different Ecosystems. - In: Zaujec, A.; Bielek, P.; Gonet, S.S. (eds) Humic Substances in Ecosystems. Bratislava, Nitra, Soil Science and Conservation Research Institute, Slovak Agricultural University, pp. 123-128.</p> <p><i>Application of TLS to phenolic root exudates:</i> Heim, A.; Luster, J.; Brunner, I.; Frey, B.; Frossard, E. 1999. Effects of aluminium treatment on Norway spruce roots: Aluminium binding forms, element distribution, and release of organic substances. Plant Soil 216: 103-116.</p> <p><i>Determination of stability constants for litter leachates:</i> Luster, J.; Lloyd, T.; Sposito, G. 1994. Aluminium (III) complexation by an aqueous leaf litter extract: quantitative characterization by molecular fluorescence spectrometry. In: Senesi, N.; Miano, T.M. (eds) Humic Substances in the Global Environment and Implications on Human Health. Amsterdam, Elsevier, pp. 1019-1024.</p> <p>Luster, J.; Lloyd, T.; Sposito, G.; Fry, I.V. 1996. Multi-Wavelength Molecular Fluorescence Spectrometry for Quantitative Characterization of Copper (II) and Aluminium (III) Complexation by Dissolved Organic Matter. Environ. Sci. Technol. 30: 1565-1574.</p>

ID	33_Montecchio_a
Author	Montecchio, Daniela; Ciavatta, Claudio; Gessa, Carlo Emanuele <i>Alma Mater Studiorum</i> University of Bologna , Department of Agroenvironmental Sciences and Technologies, Viale Fanin, 40- 40127 Bologna, Italy; dmontecc@agrsci.unibo.it; ++39 051 2096206
Parameter	Thermal behaviour of humic substances
Soil type	All types of soil
System	Field
Method	Differential Thermal Analysis (DTA)
Method description	<p><i>Sample preparation</i> Ten g of air-dried and finely ground soil samples are extracted with 100 mL of 0.5 M NaOH and stirred for 24 hour at 65°C under N₂. The suspension is centrifuged at 5,000 x g for 30 min and then filtered through a 0.22 µm filter using a Minitan S System (Millipore, Bedford MA - USA). The solution is acidified with 5 M HCl to pH < 2 to precipitate humic acids (HA) and afterwards is centrifuged at 5,000 x g for 20 min in order to separate the supernatant. The HA are dissolved with NaOH 0.5 M to achieve a Na-humate. Fulvic acids (FA) are separated from the supernatant by fractionation on solid polyvinylpyrrolidone (Ciavatta et al., 1990). Na-humate and FA are dialyzed against Millipore water, using a tubing with a molecular mass cut-off of 1000 Da, until a neutral pH was achieved, and are then freeze-dried.</p> <p><i>Analysis</i> An amount of 5 mg of HA lyophilized are weighed into alumina crucibles and first isothermally heated to 30 °C for 10 min, and then successively heated from 30 to 700 °C in dynamic air atmosphere (air flow is 5 L min⁻¹). The heating rate is 10 °C min⁻¹. Calcinated caolinite is used as reference material.</p>
Do's, don'ts, potential limitations	Thermal analyses have been proposed as a method to characterize the genetic path of coal (Mazumdar, 2000) and for investigation of soil HS from different environments (Geyer et al., 2000).
References	<p><i>Characterization of humified compounds by extraction and fractionation on solid polyvinylpyrrolidone:</i> Ciavatta, C.; Govi, M.; Antisari, L.V.; Sequi, P. 1990. J. Chromatogr. 509: 141-146.</p> <p><i>Quantitative estimation of peat, brown coal and lignite humic acids using chemical parameters, ¹H-NMR and DTA analyses:</i> Francioso, O.; Ciavatta, C.; Montecchio, D.; Tugnoli, V.; Sanchez-Cortes, S.; Gessa, C. 2003. Biores. Technol. 88: 189-195.</p> <p><i>Thermochemical history in the genetic path of coal: derivation of a novel correlation for heat of combustion:</i> Mazumdar, B.K. 2000. Fuel 79: 1267-1276</p> <p><i>Investigation of soil humic substances from different environments using TG-FT-IR and multivariate analysis:</i> Geyer, W. ; Hemidi, F.A.H. ; Bruggemann, L. ; Hanschmann, G. 2000. Thermoch. Acta 361: 139-146.</p>

ID	33_Montecchio_b
Author	Montecchio, Daniela ¹⁾ ; Ciavatta, Claudio ¹⁾ ; Gessa, Carlo Emanuele ¹⁾ ; Manunza, Bruno ²⁾ ¹⁾ <i>Alma Mater Studiorum</i> University of Bologna , Department of Agroenvironmental Sciences and Technologies, Viale Fanin, 40- 40127 Bologna, Italy; dmontecc@agrsci.unibo.it; ++39 051 2096206 ²⁾ University of Sassari. Di.S.A.A.B.A., Viale Italia, 39 - 07100 Sassari, Italy
Parameter	Acid-base properties of humic substances
Soil type	Natural and cultivated soils
System	Field
Method	Potentiometric titration
Method description	<p><i>Sample preparation</i></p> <p>Ten g of air-dried and finely ground samples are extracted, with 100 mL of 0.5 M NaOH and stirred for 24 hour at 65°C under N₂. The suspension is centrifuged at 5,000 x g for 30 min and then filtered through a 0.22 µm filter using a Minitan S System. The solution is acidified with 5 M HCl to pH < 2 to precipitate humic acids (HA) and afterwards is centrifuged at 5,000 x g for 20 min in order to separate the supernatant. The HA are dissolved with NaOH 0.5 M to achieve a Na-humate. Fulvic acids (FA) were separated from the supernatant by fractionation on solid polyvinylpyrrolidone (Ciavatta et al., 1990). Na-humate and FA are dialyzed against Millipore water, using a tubing with a molecular mass cut-off of 1000 Da, until a neutral pH was achieved, and are then freeze-dried.</p> <p><i>Analysis</i></p> <p>Potentiometric titrations are performed on about 12 mg of freeze-dried samples dissolved in 20 mL distilled water after acidification down to pH 3.0. Ionic strength buffered with 0.05 M NaCl and 0.05 M NaOH titrant is used to raise up to 10.5 pH. The titration temperature is controlled at 25 ± 0.1°C. Samples are de-aerated for 15 min with N₂ before as well as during titration.</p> <p><i>Calculation of parameters</i></p> <p>The calculation of mean value pK_A and standard deviation for a bimodal Gussian distribution of pKa values of the humic substances functional groups is performed by the computer program PGAUSS (Manunza et al., 1992).</p>
Do's, don'ts,	The HA and FA solutions have to be equilibrated for two hours, at the titration temperature, before analysis.
References	<p><i>Characterization of humified compounds by extraction and fractionation on solid polyvinylpyrrolidone:</i> Ciavatta, C.; Govi, M.; Antisari, L.V.; Sequi, P. 1990. J. Chromatogr. 509: 141-146.</p> <p><i>Dependance of acid-base properties of humic and fulvic acids on molecular weight:</i> Falzoni, A.; Seeber, R.; Tonelli, D.; Ciavatta, C.; Gessa, C.; Montecchio, D. 1998. Analusis 26: 214-219.</p> <p><i>A normal distribution model for the titration curves of humic acids:</i> Manunza, B.; Gessa, C.; Deiana, S.; Rausa, R. 1992. J. Soil Sci. 43: 127-132</p>

ID	33_Provenzano
Author	Provenzano; Maria Rosaria; Senesi, Nicola Dip. Biologia e Chimica Agroforestale e Ambientale, Università di Bari, Bari-Italy; provenza@agr.uniba.it; ++39 0805 442929
Parameter	Endothermic and exothermic reactions occurring during a programmed and controlled heating of organic matter samples
Soil type	Any soil
System	Laboratory experiments
Method	Differential Scanning Calorimetry (DSC)
Method description	<p><i>Sample preparation and fractionation:</i> Humic acids (HAs) and Fulvic acids (FAs) are isolated according to conventional procedures based on sodium hydroxide-sodium pyrophosphate extraction, precipitation by HCl to pH ~2, mild purification by successive NaOH-dissolution and HCl precipitation steps, water washing, dialysis, and final freeze-drying.</p> <p>Composted materials are analyzed directly without any treatment or extraction of the whole samples.</p> <p><i>DSC analysis:</i> In a DSC analysis, the sample is subjected to a programmed heating in controlled atmosphere. Sample and reference are both provided with individual heaters making it possible to use a "null-balance" principle. Thus, the temperature of the sample holder is always kept the same as that of the reference holder by continuous and automatic adjustment of the heater power. A signal, proportional to the difference between the heat input to the sample and that to the reference, dH/dt, is fed into a recorder converting the peak area into energy unit. The resulting thermogram shows endothermic and exothermic peaks occurring at temperatures that are related to the chemical structure and thermal stability of the sample.</p> <p>Aliquots of 5 mg of sample are placed in an aluminum pan of 50 µl capacity and 0.1 mm thickness, press-sealed with an unperforated aluminum cover of 0.1 mm thickness. An empty pan sealed in the same way is used as reference. Thermograms are measured by heating the sample from 50 to 550 °C at a rate of 20 °C/min, under an air-flow of 20 cm³/min. Indium is used as standard for calibrating the temperature.</p>
Do's, don'ts, potential limitations, untested possibilities	<ul style="list-style-type: none"> • Thermal analysis provides information on the thermal behaviour and thermal stability/lability of structural and functional components of HAs and FAs. • It can be applied to study chemical aspects of thermal reactions occurring in humic substances when they interact with pesticides and metal ions. • Further, it represents a means for assessing the maturity reached by composted materials sampled at different composting time and in final composts. • However, the structural complexity associated with humic substances and composted materials has so far hindered the possibility to perform quantitative analysis.
References	<p>Provenzano, M.R.; Senesi, N.; Piccone, G. 1998. Thermal and spectroscopic characterization of organic matter from municipal solid wastes. <i>Compost Science & Utilization</i> 6: 67-73.</p> <p>Provenzano, M.R.; Senesi, N. 1999. Thermal properties of standard and reference humic substances by Differential Scanning Calorimetry. <i>Journal of Thermal Analysis and Calorimetry</i> 57: 517-526.</p> <p>Provenzano, M.R.; Ouattmane, A.; Hafidi, M.; Senesi, N. 2000. Differential Scanning Calorimetric analysis of composted materials from different sources. <i>Journal of Thermal Analysis and Calorimetry</i> 61: 607-614.</p> <p>De Oliveira, S.C.; Provenzano, M.R.; Santiago Silva, M.R.; Senesi, N. 2002. Maturity degree of composts from domestic solid wastes evaluated by differential scanning calorimetry. <i>Environmental Technology</i> Vol. 23: 1099-1105.</p>

ID	33_Puglisi
Author	Puglisi, E.; Capri E. Istituto di Chimica Agraria ed Ambientale, UCSC, Via Emilia Parmense 84, 29110 Piacenza, Italy; edoardo.puglisi@unicatt.it; ++39 0523599345
Parameter	Bioavailable and labile fractions of hydrophobic organic compounds
Soil type	Agricultural and forest soils
System	Field soil, microcosm
Method	Non exhaustive extraction techniques (NEETs)
Method description	<p><i>Cyclodextrin extraction:</i> Samples of 1 g of soil are weighed in centrifuge polycarbonate tubes and added to 20 mL of hydroxypropyl-β-cyclodextrin (HPCD) 50 mM. The tubes are sealed, placed on an orbital shaker at 80 r.p.m. for 12 hours and then centrifuged at 4000 r.p.m. for 1 hour. After centrifugation the supernatant is filtered and ready to be analysed for HPLC contaminant quantification.</p> <p><i>Hydrophobic resins extraction:</i> Hydrophobic resins (e.g. Amberlite XAD or Tenax) are prepared by soaking in methanol to remove entrapped air and traces of residual monomeric compound and preservative agents. Approximately 3.5 g of soil, 1 g of wet resin and 25 mL of a 0.01 M CaCl₂ solution are weighed directly into polycarbonate centrifuge tube. CaCl₂ is used to prevent the dispersion of soil clay particles. The tubes are sealed, placed on an orbital shaker at 80 r.p.m. for 12 hours and then centrifuged at 4000 r.p.m. for 1 hour. After centrifugation the resin, which floats to the surface of the tubes, is recovered by vacuum filtration into an inverted glass Pasteur pipette, where it is retained by a plug of glass wool. The contaminant is then recovered by rinsing the resin in acetone and ready for HPLC quantification.</p>
Do's, don'ts, potential limitations, untested possibilities	<ul style="list-style-type: none"> • Cyclodextrins present a hydrophilic surface and an internal hydrophobic cavity: fairly soluble in water, they are at the same time able to entrap hydrophobic molecules inside their cavity, enhancing therefore their solubility. The quantity of several PAHs extracted from soil samples with cyclodextrins was shown to be correlated to the bioavailable fractions. The method is suitable only for compounds which fit properly within the internal cavity of the cyclodextrin. • Resins have instead a wider application, and may be potentially applied for the extraction of the bioavailable fraction of several hydrophobic compounds. • The feasibility of application of these techniques for the extraction of the bioavailable fraction is however still lacking for most organic contaminants.
References	<p>Puglisi, E.; Patterson, C.J.; Paton, G.I. 2003. Non exhaustive extraction techniques (NEETs) for bioavailability assessment of organic hydrophobic compounds in soils. <i>Agronomie</i> 23: 755-756.</p> <p>Fragoulis, G.; Trevisan, M.; Puglisi, E.; Capri, E. 2005. A model assessing bioavailability of persistent organic pollutants in soil. In: Nützmann, G.; Viotti, P.; Aagaard, P. (eds.) <i>Reactive transport in soil and groundwater: processes and models</i>. Springer Verlag, Heidelberg, pp. 39-50.</p>

ID	33_Sanchez_Cortes
Author	Sanchez-Cortes, Santiago; Garcia-Ramos, Jose Instituto de Estructura de la Materia (CSIC), Departamento de Espectroscopía Vibracional y Procesos Multifotónicos, Serrano 121, 28006-Madrid, Spain imts158@iem.cfmac.csic.es; ++34 915616800
Parameter	Structure and functional groups of humic substances
Soil type	Any soil
System	Field
Method	Surface-Enhanced Raman Spectroscopy (SERS)
Method description	<p>The SERS has been applied to the study of highly fluorescent molecules at trace concentrations. In fact picograms of the studied molecule and, even, the single molecule, can be detected by means of this technique. This method involves the adsorption of the molecule on a roughened metal surface, which leads to a subsequent enhancement of the Raman signal.</p> <p><i>Colloid preparation:</i></p> <p><i>Ag-citrate colloid.</i> A total of 1 ml of a 1% w/v trisodium citrate aqueous solution is added to 50 ml of a boiling 10^{-3} M silver nitrate aqueous solution, and kept boiling for 1 h. The colloid obtained shows a turbid gray aspect.</p> <p><i>Ag-hydroxylamine colloid.</i> A total of 4.5 ml of a sodium hydroxide solution (0.1 M) were added to 5 ml of a 6×10^{-2} M hydroxylamine hydrochloride solution. Then, the mixture is added rapidly to a 1.11×10^{-3} M of a silver nitrate aqueous solution, shaking until a homogeneous mixture is obtained. The resulting colloid showed a milky gray colour.</p> <p><i>Ag-Photoreduced colloid.</i> This colloid is obtained in-situ by dissolving the humic substance in a 10^{-3} M solution of silver nitrate. The laser irradiation induces the reduction of the cationic silver leading to the formation of Ag nanoparticles.</p> <p><i>Sample preparation:</i></p> <p>An aqueous solution of humic substance is obtained dissolving 1 mg of the lyophilized humic material with 1 mL of distilled water. Samples for Raman measurements are prepared by adding 100 μL of the humic substances solution to 1 mL of the silver colloid.</p> <p><i>Analysis:</i></p> <p>Spectra are recorded by a Normal Raman or Micro-Raman Spectrophotometer. The samples are irradiated with lines at 514.5 and 785 nm provided by Ar⁺ ionized gas and diode lasers, respectively. Resolution is set at 2-4 cm^{-1} and a 90° or 180° geometry is used to record the data. The laser power on the sample is 1-40 mW.</p>
Do's, don'ts, potential limitations, untested possibilities	<ul style="list-style-type: none"> • The SERS technique is much more sensitive to those molecular groups which are closer to the metal surface. This means that the analysis is not quantitative. However, this effect makes this technique more sensitive to structural changes occurring in the humic substances. • The molecular groups having a larger Raman emission are more enhanced. This is the case of the aromatic groups, chiefly the polycyclic aromatic moieties which may exist in the macromolecule.

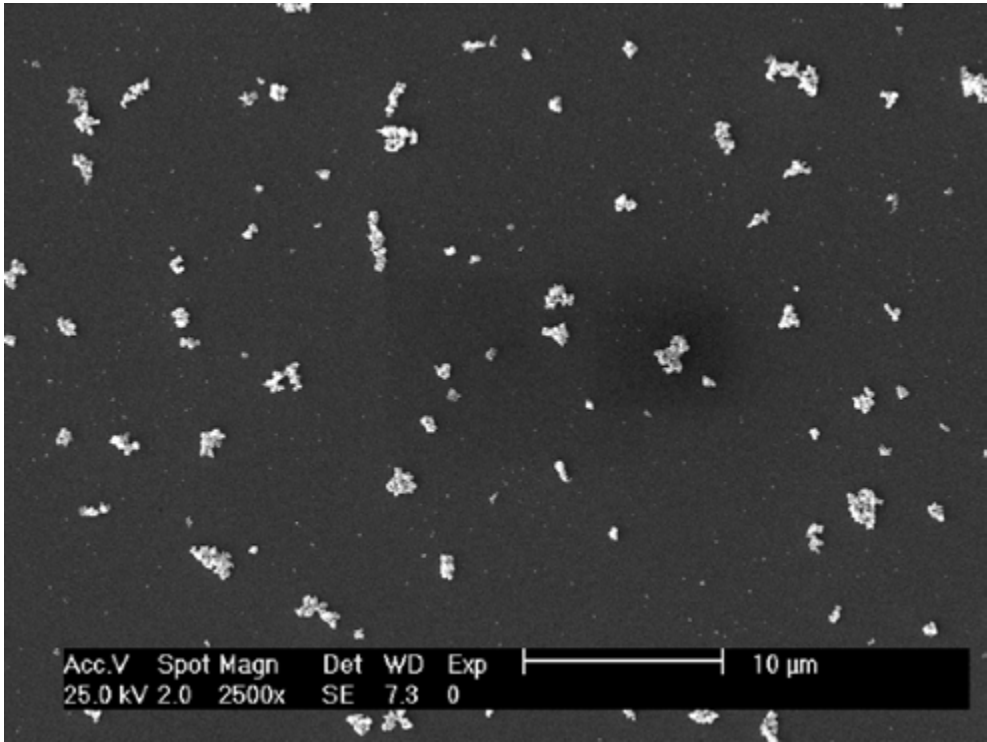
	<ul style="list-style-type: none"> This technique could be applied to check the effect of pH, humic substances concentration on the tridimensional structure of the macromolecules. In addition, SERS technique could be applied in the study of the interaction of small molecules, such as polycyclic aromatic hydrocarbons (PAHs) and pesticides could, with the different humic substances fractions.
References	<p><i>Surface-enhanced spectroscopy:</i> Moskovits, M. 1985. Rev. Mod. Phys. 57: 783-789.</p> <p><i>pH Dependence adsorption of fractionated peat humic substances on different silver colloids studied by surface-enhanced Raman spectroscopy:</i> Sanchez-Cortes, S.; Francioso, O.; Ciavatta, C.; Garcia-Ramos, J.V.; Gessa, C. 1998. J. Coll. Interface. Sci., 198: 308-318.</p>
Links	<p>http://nte-serveur.univ-lyon1.fr/nte/spectroscopie/raman/H1TUTO~1.htm</p> <p>http://www.npl.co.uk/smd/npl_research/cur_res_sers.html</p>
Additional information	<p>The sensibility of the SERS technique can be largely increased by immobilizing the Ag nanoparticles on a substract surface such as glass or silica.</p> <p>Fig. 1. A micrograph of the nanoparticles acted for SERS spectroscopy</p> 

ID	33_Trapp
Author	Trapp, S. ¹⁾ ; Ciucani, G. ²⁾ ¹⁾ Institute of Environment & Resources, Technical University of Denmark, DK-2800 Kongens Lyngby, Denmark stt@er.dtu.dk +45 45251622 ²⁾ SIPCAM S.p.A.- Via Vittorio Veneto 81. Salerano sul Lambro (Lodi); Italy gciucani@sipcam.it; ++39 0371 596 229
Parameter	Xenobiotics phytotoxicity
Soil type	Any kind of soil or sludge, but not too loamy and stony; spiked solutions, too
Plant species	Basket willows (<i>Salix viminalis</i>) or other Salicaceae
System	Rapid laboratory test for acute toxicity to trees
Method	Willow Tree Transpiration Test
Method description	The test system uses the change of weight caused by transpiration as a toxicity indicator. Tree cuttings are pre-grown in bucket. Once they have roots and leaves, they are transferred to 500 ml Erlenmeyer flasks containing approximately 400 ml ISO 8692 nutrient solution. Then the system is closed with cork stoppers having holes of the same diameter as the cuttings to leave the leaves and a part of the stem outside the flask. The system is placed into a growth chamber with constant artificial conditions. The weight of the whole apparatus is determined to measure the transpiration. After one day, the nutrient solution is exchanged with a spiked solution, a soil, or another substrate. An inhibition of the transpiration, compared to the initial transpiration and controls, indicates the toxic effect.
Do's, don'ts, potential limitations, untested possibilities	<ul style="list-style-type: none"> • Transpiration is a good parameter for measuring toxic effects. It is a cheap and fast method for measuring acute toxicity of chemicals and polluted soils. • Useful in phytoremediation for the selection of tree varieties and species that are resistant to the relevant soil pollutants. Note that trees are usually less sensitive than other test species, such as algae or daphnia. • The test has been applied in several laboratories, with good results. Parallel to the toxicity testing, the mass balance of the chemical can be established.
References	<p>Trapp, S.; Zambrano, K.C.; Kusk, K.O.; Karlson, U. 2000. A phytotoxicity test using willow. Arch. Environ. Contam. Toxicol. 39: 154-160.</p> <p>Trapp, S.; Ciucani, G.; Sismilich, M. 2004. Toxicity of tributyltin to willow trees. Environ. Sci. & Pollut. Res. 11: 327-330.</p> <p>Larsen, M.; Ucisik, A.; Trapp, S. 2005. Uptake, metabolism, accumulation and toxicity of cyanide in willow trees. Environ. Sci. Technol. 39: 2135-2142.</p> <p>Yu, X.Z.; Trapp, S.; Zhou, P. 2005. Phytotoxicity of cyanide to weeping willow trees. Environ. Sci. & Pollut. Res. 12: 109-113.</p> <p>Trapp, S.; Karlson, U. 2001. Aspects of phytoremediation of organic pollutants. J. Soil & Sediments 1: 37-43.</p>
Links	www.er.dtu.dk/homepages/stt

ID	33_Tugnoli
Author	Tugnoli, Vitaliano ¹⁾ ; Francioso, Ornella ²⁾ ¹⁾ Dipartimento di Biochimica, Università degli Studi di Bologna, Via Belmeloro 8/2, 40126- Bologna, Italy; vitaliano.tugnoli@unibo.it; ++39 051 2094280 ²⁾ Dipartimento di Scienze e Tecnologie Agroambientali, Università degli Studi di Bologna, V.le Fanin 40, Bologna 40126, Italy ornella.francioso@unibo.it; ++39 051 2096205
Parameter	Characterization of low molecular weight soil organic matter fraction
Soil type	Any soil
System	organic matter from soil
Method	Extraction of low molecular weight components and their identification using ¹H Nuclear Magnetic Resonance Spectroscopy (¹H NMR)
Method description	<i>Extraction of low molecular weight organic components:</i> Five g of soil is placed into a 100 mL flask and extracted overnight with 50 mL of 0.5 M hydrochloric acid using an end-over-end shaker at 100 rpm and at 65 °C .The resulting solution is filtered through nr. 42 Whatman filter paper and freeze-dried before analysis (Francioso et al., 2000). <i>Analysis:</i> The ¹ H NMR spectra are obtained on 0.5 M sodium deuterate solution of lyophilized material (20-30 mg) with a Bruker ACF 250 spectrometer (Karslsruhe, Germany) at room temperature (22 ± 1C°) with a 5-mm multinuclear probe. The spectra are accumulated with 16 K data point, one pulse sequence, 40° pulse angle, 3 s relaxation delay and a sweep width of 2.5 kHz. To obtain a satisfactory signal to noise ratio 1000-2000 scans are needed. Gated irradiation is applied between acquisitions to presaturate the residual water peak. Chemical shifts are relative to 3-trymethylsilyl tetra deuterio propionate (TSP).
Do's, don'ts, potential limitations, untested possibilities	<ul style="list-style-type: none"> • Paramagnetic metals can influence the signal but this can be resolved using Chelex 100 (Bio-Rad Laboratories, Richmond, CA) cation exchange resin to remove metals (Fan et al., 1997) • The advantage of this approach is the ability to detect unknown and unexpected components and to obtain structure identification from complex mixtures (Wilson et al., 1983; Fan et al., 1996; Taddei et al., 2002). Furthermore, this method eliminates fractionation and purification of the sample and the analysis time is reduced and the loss of some important compounds is minimized.
References	<i>Metabolite profiling by one – and two dimensional NMR analysis of complex mixtures:</i> Fan, T. W.M., 1996. Prog. Nucl. Magn. Reson. Spectrosc. 28:161-219. <i>Comprehensive analysis of organic ligands in whole root exudates using nuclear magnetic resonance and gas chromatography-mass spectroscopy:</i> Fan, T.W.M.; Lane, A.N.; Pedler, J.; Crowley, D.; Higashi, R.M. 1997. Anal. Biochem. 251: 57-68. <i>Spectroscopic characterization of soil organic matter in long-term amendment trials:</i> Francioso, O.; Ciavatta, C.; Sanchez-Cortes, S.; Tugnoli, V.; Sitti, L.; Gessa, C. 2000. Soil Sci. 165: 495-504 <i>Vibrational, ¹H-NMR Spectroscopic, and thermal characterization of gladiolus root exudates in relation to Fusarium oxysporum f. sp. gladioli resistance:</i> Taddei, P.; Tugnoli, V.; Bottura, G.; Dallavalle, E.; D'Aulerio, A.Z. 2002. Biopolymers 67: 428–439 <i>¹H NMR nuclear magnetic resonance spectroscopy of soil humic acid.</i> Wilson, M.A.; Collin, P.J.; Tate, K.R. 1983. J. Soil Sci. 34 : 297-304.
Links	http://www.aist.go.jp/RIODB/SDBS/menu-e.html

ID	41_Biro
Author	Biró, Borbala Research Institute for Soil science and Agricultural Chemistry HAS, Herman O. ut 15, H-1022 Budapest, Hungary +361-2243-656, +361-2243-627; biro@rissac.hu
Parameter	Bacterial numbers
Soil type	any
Plant species	any
System	plant root system
Method	Root dilution analysis
Method description	<p>Sampled root segments are roughly washed in tap water, and after drying in a paper towel 1g is analysed for water content and another 1 g is shaken in sterile DW (9 mL) for 5 minutes. After removing the washed roots into a new sterile DW flask, the same procedure needs to be repeated another 6 times. Flasks 6 and 7 need to contain 1g sterile quartz sand for a more effective removal of attached root surface (rhizoplane) bacteria. Roots, after this procedure must be macerated with a sterile pestle & mortar using 1 g sterile quartz sand and 10 ml DW to obtain a rather homogeneous root suspension. After this procedure a dilution series needs to be prepared up till 10^8, and 100 μl aliquots are equally seeded to selective agar plates (King B). The incubation period is 24-48^h at 28 °C, and UV lamps are used for the calculation of <i>fluorescent putida</i>-type plant-growth promoting (PGPR) rhizobacteria (<i>Pseudomonas</i> sp.), as published by King <i>et al.</i> (1954). Total counts of other heterotroph can be assessed on Nutrient plates. The ratio of the total and PGPR bacterial counts can be estimated as a function of the plant species of different origin. Microbial counts from the washing water of 1-7 and from the root-water suspension 1-8, can represent the different sections of the rhizoplane and the inner rhizosphere. Data are presented on a 1g “dry root” basis.</p> <p>In the case of associative <i>Azospirillum</i>, <i>Herbaspirillum</i> or other diazotroph bacteria the root –quartz sand–water suspension is being used and Nfb selective semisolid tubes are necessary for the “most probable number” (Nfb) calculations, as described by Hegazi <i>et al.</i> (1979).</p>
Do's, don'ts, potential limitations, untested possibilities	One limitation is the “selectivity” of the media used, as in other microbial counts from soils or other substrates. There are several different selective plates used in different laboratories. This methodology can be also used, however for the selection of other endophytes (i.e. microfungi, on “malt-extract” agar), in which the abundance and ratio of rhizobacteria and endophyte fungi can be calculated. Fast-growing characteristics of colonies may prevent the growth of other slow-growing species (selection of appropriate incubation time, temperature and media are necessary). In late assessments, CFU counting may be impossible in some cases, due to the faster growth of the PGPR colonies. However the method is good, for the isolation of other beneficial microbes (biocontrol strains or siderophore producers).
References	<i>First description of the inner rhizosphere and rhizoplane sampling in:</i> Tepper, E.C. 1945. TSZHA Dokladü.Vüp. 2: 131-136.

	<p><i>Recommended selective media for the PGPR rhizobacteria:</i> King, E.O.; Ward, M.K.; Raney, D.E. 1954. J. Lab. Med. 44: 301-307. Simon, A.; Rovira, A.D.; Sands, D.C. 1973. J. Appl. Bacter. 36: 141-145.</p> <p><i>Modification of the earlier plate-counting procedure is possible by:</i> Angerer, I.P.; Biró, B.; Köves-Péchy, K.; Anton, A.; Kiss, E. 1998. Indicator microbes of chlorsulfuron addition detected by a simplified soil dilution method. Agrokém. Talajt. 47: 297-305.</p> <p><i>Application of selected PGPR strains for replant-disease control:</i> Biró, B.; Magyar, K.; Várady, G.; Kecskés, M. 1998. Specific replant disease reduced by PGPR rhizobacterium on apple seedlings. Acta Horticult. 477: 75-81.</p> <p>Biró, B.; Köves-Péchy, K.; Tsimilli-Michael, M.; Strasser, R.J. 2006. Role of Beneficial Microsymbionts on the Plant Performance and Plant Fitness. In: Mukerji, K.G.; Manoharachary, C.; Singh, J. (eds.)- Microbial Activity in the Rhizosphere. Springer-Verlag, Berlin, pp.:265-296.</p>
Links	Further publications of B. Biró on the applicability of method at www.taki.iif.hu/soilbio/soilbiol.html .
Additional information	Detailed protocol available from the author.

ID	41_Blaschke
Author	Blaschke, H. ¹ ; Nikolova, P. ¹ ; Raidl, S. ² ; Matyssek, R. ¹ ¹ Technische Universität München, Center of Life and Food Sciences, Ecophysiology of Plants, Am Hochanger 13, 85354 Freising, Germany blaschke@bot.forst.tu-muenchen.de; ++49-08161-71-4575 ² Ludwig-Maximilians-Universität München, Department Biology I, Biodiversity Research, Systematic Mycology, Menzinger Straße 67, 80638 München, Germany; s.raidl@lrz.uni-muenchen.de; ++49-089-17861-236
Parameter	Ectomycorrhiza: exploration types, hyphal network, rhizomorphs, and their response to chemical and physical properties of the soil environment
Soil type	forest soil, organic litter layer
Plant species	Conifers and hardwoods (eg <i>Picea abies</i> , <i>Fagus sylvatica</i>)
System	Microcosm
Method	Slim cases for digital recording of ectomycorrhiza formation <i>in situ</i>
Method description	<p>A novel inexpensive and simple 'microcosm approach' used for <i>in situ</i> mapping of ectomycorrhizal mycelia, emanating hyphae and rhizomorphs, is based on a field technique, and was developed to quantify tree fine root production with emphasis on exploration types of ectomycorrhizal root organs, traits of individual fine root segments (spacing, branchiness, longevity of laterals), and seasonal growth dynamics of cohorts of roots produced in the organic top soil layer. This minirhizotron system for observation and recording consists of a transparent super slim case (TSSC) commercially available for safe-keeping of CD's or DVD.</p> <p>While the opening of lower shell of the TSSC is covered with a PET net and left in place in the fermentation layer, the upper shell can be opened at time intervals during the entire growth season (even in winter, when the organic soil layer is not frozen) for studying tree specific rooting pattern and <i>in situ</i> mycorrhizal colonization on individual fine root screens (10x10cm wide). A more detailed description of the modified plastic TSSC for clamped support of fine laterals of Norway spruce that arise in the top soil layer along the parent axis of non-woody roots is presented by 12_Nikolova.</p> <p>Observation and recording equipment included a high resolution digital zoom camera system (KAPPA[®] DX-30) , and the KAPPA[®] Image base control software producing images of roots and fungal structures which contrast strongly with the root screens even if brightness levels on the first floor are low. Fine root attributes, growth rates, periodicity and dynamics of ectomycorrhiza development, branching characteristics of ectomycorrhizal exploration types, formation of extraradical mycelium, rhizomorphs and hyphal networks can be measured and classified with WinRHIZO[®]Pro version 2003b (Regent Instruments Inc, Canada) based on color images of <i>in situ</i> records. Functional attributes of ectomycorrhizal morphotypes (Agerer 2001) were analysed using eg., color of fine root organs, diameter class, topology and space exploitation by the mycelial network of ectomycorrhizal fungi using Regent's true color application program combined with link analysis of branching systems according to definitions of Fitter (1991) classifying links and segments.</p>

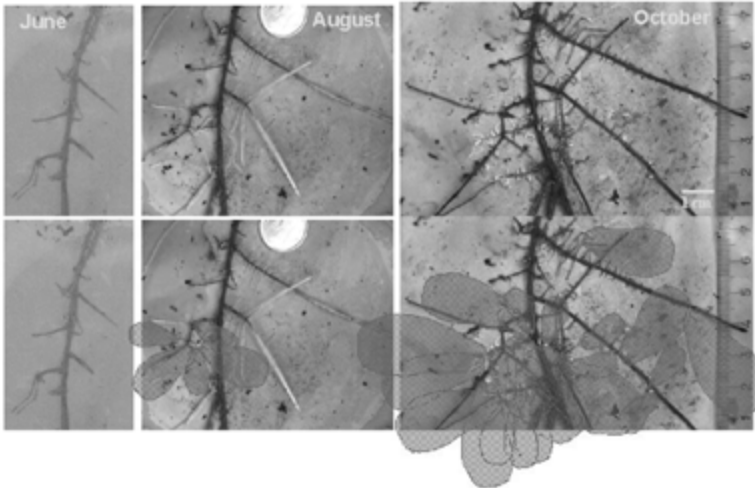
Do's, don'ts, potential limitations, untested possibilities	Horizontal installation of the TSSC and arrangement of exposed laterals in this sandwich-like cuvette in between two PET planes (mesh size 40µm), and insertion into the recently stabilized litter layers, makes it easy to obtain information on fine root growth dynamics and colonization by ectomycorrhizal fungi in time series during the entire root lifespan without interference of obscuring rhizosphere soil. Functional characteristics eg. ectomycorrhizal species abundance along mother roots and distribution in their natural position, as well as spread of extramatrical mycelia or rhizomorphs, could provide a basis for calculating fine root functional efficiency parameters. <i>In situ</i> recording of time series of ectomycorrhizal development combined with direct monitoring of metabolic processes in both individual fine root cohorts and in the mycorrhizosphere of the 'wood-wide-web' represent a significant innovation for plant and community ecology providing data on belowground responses tree species to small scale changes in the edaphic environment.
References	Regent Instrument Manual WinRHIZO 2003b, Basic, Reg & Pro, For washed root measurements; Regent Instruments Inc., Quebec, Canada. Agerer, R. 2001. Exploration types of ectomycorrhizal mycelial systems. <i>Mycorrhiza</i> 11: 107-114.
Links	www.forst.uni-muenchen.de/EXT/LST/BOTAN/INSTITUT/nikolova01.html www.regentinstruments.com/
Additional information (see also colour plate on p. 535)	 <p>Fig. 1. Color images of individual fine root segments of Norway spruce used to determine establishment and growth dynamics of ectomycorrhiza inside TSSC frames (root screen 10x10cm). Individual frames of the resulting binary image of root segment (see 12_Nikolova). Enlarged consecutive images of roots from time series are used for detailed examination of ectomycorrhizal colonization and formation of rhizomorphal connections, soil exploitation, and space sequestration in-between ramified mycorrhizal systems of <i>Xerocomus</i> spec. Bar length represents 10mm. (Nikolova and Blaschke 2002/2005, unpublished data).</p>

ID	41_Dazzo
Author	Frank B. Dazzo Dept. of Microbiology & Molecular Genetics Michigan State University East Lansing, Michigan 48824 USA dazzo@msu.edu; 01-517-355-6463 ext. 1587
Parameter	Patterns of Spatial Distribution of the Pioneer Rhizoplane Microflora
Soil type	light textured soils
Plant species	White Clover (<i>Trifolium repens</i> L.)
System	Young seedlings growing in light textured soil
Method	Visualization of the rhizoplane microflora by computer-assisted microscopy, spatial analysis by CMEIAS image analysis
Method description	<p><i>Sample preparation:</i> Plant seeds 0.5 cm below the moistened soil surface. After 2 days of germination, gently excavate seedlings and transfer to 10 cm diameter dishes containing 17 ml isotonic plant growth medium, and soak for 30 min with occasional shaking. Then transfer seedlings to new dishes containing 17 ml isotonic plant growth medium, seal with Parafilm, and shake on a gyratory platform for 2 hrs at 100 rpm. Remove seedlings, stain with acridine orange solution (1:10,000 w/v in 1% NaPPi) for 1 minute. Transfer to a beaker and wash with several changes of 1% NaPPi solution. Mount seedlings in 1:1 v:v 1% NaPPi solution + photobleaching retardant (e.g., Vectashield, Citifluor) on clean glass slides, add a coverslip, and store in a dark humid chamber until ready to examine by microscopy.</p> <p><i>Microscopy, acquisition of digital images, image processing</i> Acquire georeferenced, 8-bit grayscale rhizoplane images of fluorescent microbes on seedling rhizoplanes using laser scanning confocal microscopy (63x objective, FITC fluorescence optics). A rhizoplane sample covering 4- 5 mm of root length is adequate. Name and save each image file to identify its georeferenced position relative to the root tip landmark origin. [Optional: after image acquisition, rinse seedlings in isotonic plant medium and process for scanning electron microscopy]. Edit images so the foreground pixels of each microbial object have brightness values that lie outside the range that defines the background. Then construct a loss-less mosaic image derived from the individual georeferenced images so the (x, y) spatial coordinates of each fluorescent microbe are retained relative to the landmark origin position.</p> <p><i>CMEIAS image analysis</i> Download, install, and review the user manual / training tutorial of CMEIAS v.1.27 operating within Uthsca ImageTool v. 1.27. Open, spatially calibrate and threshold images to find objects, place object counts in results window, extract the area and centroid x y coordinates of each foreground microbe object, measure the length of each microbe's 1st and 2nd nearest neighbor distances and its Cluster Index (1/1st nearest neighbor distance). Measure the area of each image, and the density and frequency of microbial objects per image quadrat. From these image analysis data one can compute various plot-less, plot-based, and geostatistical parameters that define the <i>in situ</i> spatial distribution of the rhizoplane microflora, e.g., % substratum coverage, % of image quadrats containing microbes, several indices of dispersion,</p>

	<p>numerous tests for spatial randomness and aggregation, geostatistical autocorrelation and semivariogram modeling, and development of kriging maps depicting the spatial distribution of local density for microbes over the entire rhizoplane domain, even in areas not sampled (e.g., obscured by root hairs or residual soil).</p>
Do's, don'ts, potential limitations, untested possibilities	<p>This method to dislodge rhizosphere soil from white clover seedlings will enable approximately 80% of the rhizoplane surface to be visualized without obvious damage to the root hairs. The method does not work as well for seedlings of some other plants (e.g., canola) that develop a higher density of longer root hairs, since excessive soil remains entrapped between them, obscuring the rhizoplane surface. Also, use of vortexing or glass beads will damage the root hairs.</p>
References	<p>Yanni, Y.G. et al. 2001. The beneficial plant growth-promoting association of <i>Rhizobium leguminosarum</i> bv. <i>trifolii</i> with rice roots. <i>Austr. J. Plant Physiol.</i> 28: 845-870.</p> <p>Liu, J.; Dazzo, F.B.; Glagoleva, O.; Yu, B.; Jain, A.K. 2001. CMEIAS: a computer-aided system for the image analysis of bacterial morphotypes in microbial communities. <i>Microb. Ecol.</i> 41: 173-194.</p> <p>Dazzo, F.B.; Joseph, A.R.; Goma, A.B.; Yanni, Y.G.; Robertson, G.P. 2003. Quantitative indices for the autecological biogeography of a <i>Rhizobium</i> endophyte of rice at macro and micro spatial scales. <i>Symbiosis</i> 35: 147-158.</p> <p>Dazzo, F.B. 2004. Applications of quantitative microscopy in studies of plant surface microbiology. In: A Varma et al. (eds.). <i>Plant Surface Microbiology</i>. Springer-Verlag, Germany, pp. 503-550.</p> <p>Dazzo, F.B.; Schmid, M.; Hartmann, A. 2006. Use of immunofluorescence microscopy and Fluorescence In Situ Hybridization combined with advanced image analysis software tools to study the autecology of soil- and plant-associated microbes. In: Lipson, D. et al. (eds.). <i>Manual of Environmental Microbiology</i>, 3rd edition, American Society for Microbiology Press, Washington, DC, in press.</p>
Links	<p>http://cme.msu.edu/cmeias/ http://ddsdx.uthscsa.edu/dig/itdesc.html http://lter.kbs.msu.edu/Meetings/2004ASM/Abstracts/Dazzo.htm http://www.trinitysoftware.com/lifesci2/ http://www.geostatistics.com/ http://www.ips.com.pl/cgi-bin/opisy.cgi?354000923X&S</p>
Additional information	<p>Some of the measurements featured here must be analyzed manually using the current free software download (ver. 1.27 of CMEIAS / Uthscsa ImageTool). A software upgrade of CMEIAS ver. 3.0 is being developed to operate in Uthscsa ImageTool ver. 3.0 and will include many of these measurement features that can be utilized in an automatic mode of object analysis and cumulative object analysis. Also, a CMEIAS Color Segmentation program is being developed to assist in the segmentation of colored microbes in RGB images (e.g., immunofluorescence, FISH, BacLight Live/Dead). Brief descriptions of these software upgrades under development plus announcements of their availability are indicated at our CMEIAS website: http://cme.msu.edu/cmeias.</p>

ID	41_Dennis_a
Author	Dennis, Paul; Miller, Anthony; Hirsch, Penny. Rothamsted Research, Harpenden, Hertfordshire AL5 2JQ, UK paul.dennis@bbsrc.ac.uk; ++44 1582 763133
Parameter	Non-destructive sampling of bacteria
Soil type	All soils
Plant species	Validated with <i>Brassica napus</i>
System	Rhizoboxes
Method	Non-destructive micro-scale sampling of bacteria from a root surface using a tungsten rod with a standardised sampling area controlled by a micromanipulator
Method description	<p><i>Concept:</i> A surface such as the rhizoplane is touched with the tip of a sampling rod to collect bacteria, which may be recovered for culture/culture-independent microbiological analyses. The method is non-destructive and allows repeated measurements from the same plants over time. By laser cutting the rods a tip of standardised surface area is achieved which enables expressing bacterial samples per unit area. The scale of the sampling tip is designed to allow separate measurements within different zones on the root with contrasting exudation patterns. In principle, this sampling technique could be applied to any surface where micro-scale interactions are of interest, and will allow the detailed dynamic mapping of key rhizosphere processes such as nutrient cycling and pathogen responses.</p> <p><i>Materials:</i> The ends of tungsten rods (\varnothing 130 μm; Science Products (SPT) GmbH, Hofheim, Germany) are laser-cut (Laser Micromachining Centre, IBMM, University of Wales, Bangor, UK) to achieve sampling tips of standardised surface area (Fig 1). Cut rods are then mounted in 'pulled' borosilicate glass capillary tubes (commonly used as electrodes in electrophysiology) and fixed in place with Super Glue (Loctite® Easy Brush Super Glue, Henkel Consumer Adhesives, Cheshire, UK). The sampling rod is mounted on a micromanipulator (Prior Scientific, Cambridge, UK) that enables the tip to be directed towards a target.</p> <p><i>Sampling:</i> For rhizoplane sampling, the roots of a plant grown in a soil rhizotron are viewed using a dissecting microscope and the sampling tip is touched on the root surface (Fig 2). After making surface contact the tip is moved away from the root and removed from the manipulator. Bacteria adhered to the tip are recovered by sonicating at low power in 10 μl of buffer stored in a microtube supported by a polystyrene float in a water bath (Ultrasonik 300, JM Ney, Bloomfield, CT, USA) containing ice water. The choice of buffer will differ depending on the intended sample analysis. We have used 1X Phosphate Buffered Saline solution for culture dependent analysis and microLYSIS-PLUS® (Microzone Ltd, Lewes, UK) for extracting DNA.</p>
Do's, don'ts, potential limitations, untested possibilities	<ul style="list-style-type: none"> • Tips are reusable. They are cleaned by sonicating at high power 3x in filtered ethanol then sterilised by 30 min exposure to hard UV light. • Tips pick a diverse range of bacteria. This has been shown by DNA fingerprinting by using ERIC PCR and DGGE. • Scanning electron microscopy revealed that the tips pick a diverse range of microorganisms although these have never been investigated (Fig. 3).

- The pickup efficiency of the tips has not been fully evaluated. We assume microorganisms firmly attached to the root surface are less likely to adhere to the tip.

Additional information (see also colour plate on p. 535)

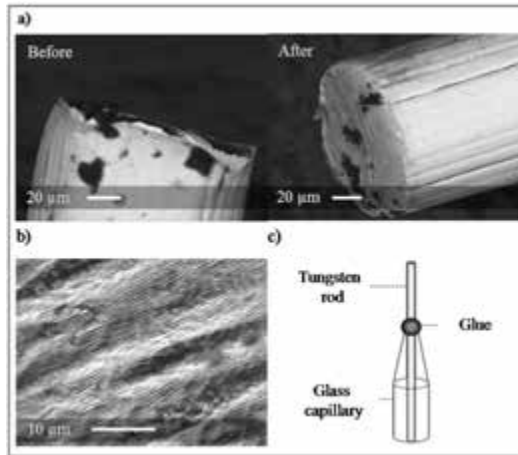

Fig. 1 Scanning electron micrographs of: (a) tungsten rod before and after laser cutting; (b) cut end of tungsten rod; (c) diagram of micro-sampler assembly.

Fig. 2 Sampling setup

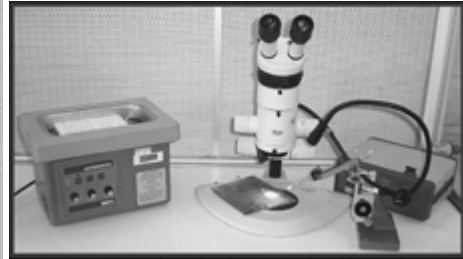
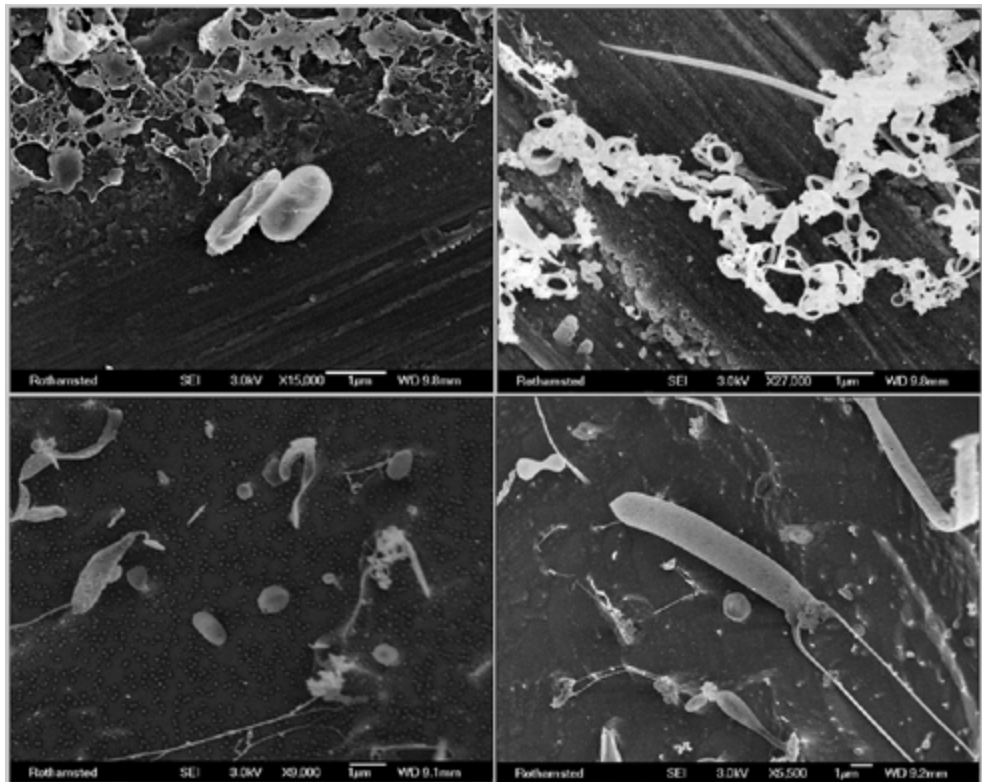
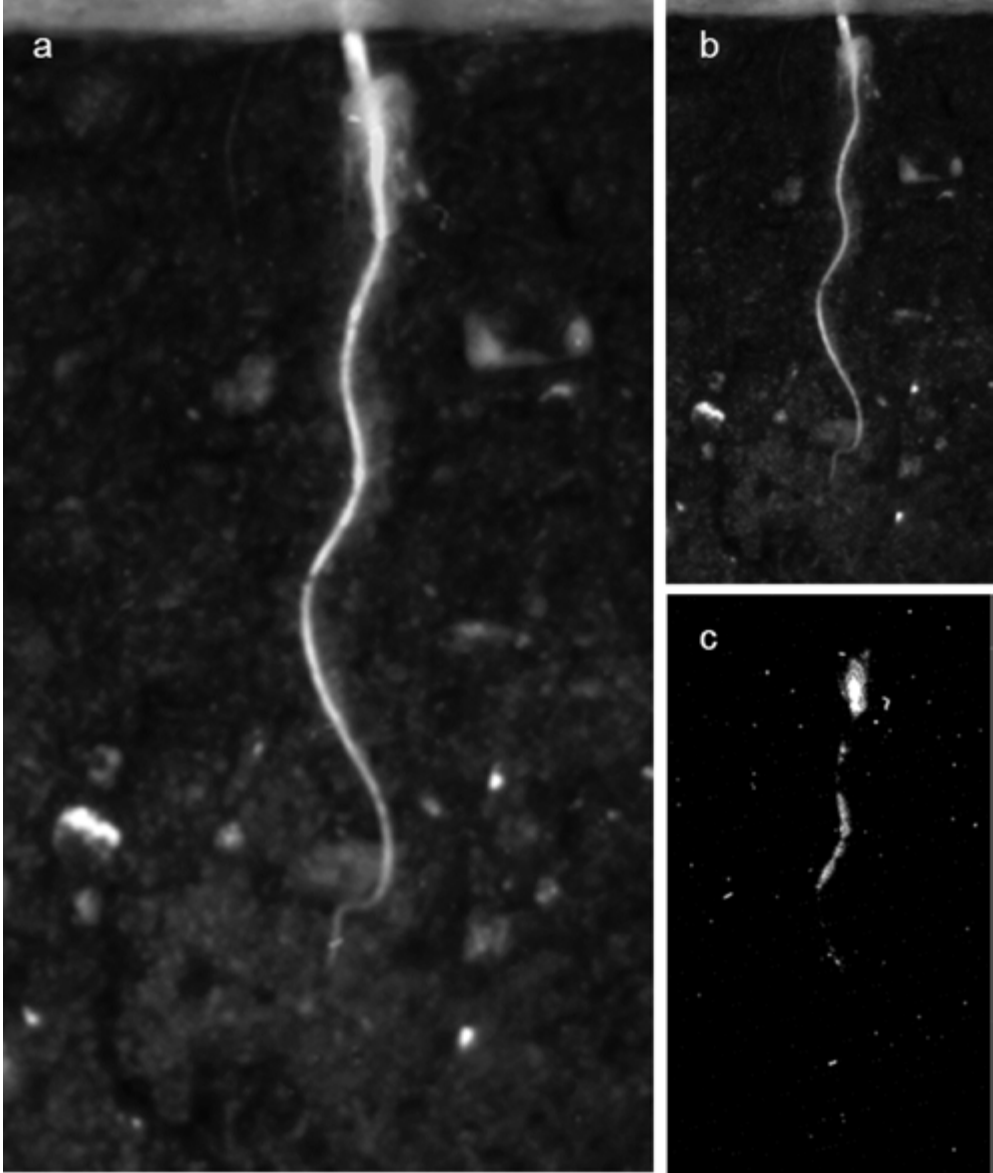

Fig. 3 False colour scanning electron micrographs of cryo-fixed, chromium coated microsample contents. Images demonstrate diverse range of sizes and morphologies of microorganisms. We thank Jean Devonshire (Rothamsted Research) for assistance. ↓



ID	41_Dennis_b
Author	Dennis, Paul; Miller, Anthony; Hirsch, Penny. Rothamsted Research, Harpenden, Hertfordshire, AL5 2JQ, UK paul.dennis@bbsrc.ac.uk; ++44 1582 763133
Parameter	Visualisation of rhizosphere bacterial colonisation patterns
Soil type	All soils
Plant species	All plants
System	Rhizoboxes
Method	CCD imaging of rhizosphere colonisation patterns of <i>Pseudomonas fluorescens</i> SBW25 luxCDABE from soil
Method description	<p><i>Preparation of bioluminescent bacterial inoculum:</i> <i>Pseudomonas fluorescens</i> SBW25 luxCDABE is grown in Tryptic Soya Broth (TSB) (Oxoid, UK) at 28 °C, 200 rpm. Cells, at the late exponential growth phase, are harvested by centrifugation (15 min, 4000 X g), the supernatant is removed and the pelleted cells are resuspended in an equal volume of sterile reverse osmosis water (RO H₂O). This washing process is repeated three times and the cell suspension is then returned to 28 °C, 200 rpm for 48 h. <i>Note:</i> an inoculation density of 10⁶-10⁷ cells g⁻¹ soil is thought to be appropriate for visualisation of bacterial rhizosphere colonisation as the population size should vastly out number that of other species, therefore increasing the probability of the bioluminescent strain to establish. The volume of the culture is determined by the intended volume of soil to be inoculated.</p> <p><i>Soil inoculation procedure:</i> Starved cells are harvested by centrifugation (15 min, 4000 X g), the supernatant is removed and the cells are resuspended in sterile RO H₂O by vigorous shaking. The starved cell suspension is then thoroughly mixed with the soil in proportions appropriate to achieve the intended inoculation density. Inoculated soil is equilibrated for 72 h in a sterile light-tight breathable container at 28 °C prior to setup of rhizoboxes and planting of seedlings.</p> <p><i>Image capture:</i> The imaging equipment consists of a CCD camera (Roper Scientific, Tucson, AZ, USA and Princeton Instruments, Trenton, NJ, USA) with a Nikkor 50 mm f 1:1.2 lens (Nikon, Japan) connected to a computer operating the MetaMorph Ver4.5r6 software package (Universal Imaging Corporation™, Downingtown, PA, USA). The camera, cooled to -120 °C with liquid nitrogen, is mounted in a light-tight box (containing a lamp). Rhizoboxes are placed in the light-tight box with roots exposed for imaging. Two images are captured: (a) a bright field image (taken with the lamp on exposed for ca. 52 milliseconds at f1.2), and (b) a dark field image (taken with the lamp off exposed for 40 min at f1.2). The dark field image is converted to pseudo colour and overlaid on the bright field image.</p>
Do's, don'ts, potential limitations, untested possibilities	<ul style="list-style-type: none"> Working distance, aperture, light/dark field exposure times and overlay settings should all be standardised to allow comparison between different rhizoboxes In pre-sterilised soil, cells will proliferate where rhizosphere conditions are amenable and can be visualised by their luminescence. In non-sterile systems, colonisation patterns of <i>P. fluorescens</i> SBW25 luxCDABE are more variable due to competition with indigenous organisms; therefore, several replicates must be used to identify general trends

	<ul style="list-style-type: none"> • <i>P. fluorescens</i> SBW25 <i>luxCDABE</i> is genetically modified and should be treated appropriately • The expression of bacterial luciferase operon requires ATP from cell metabolism making it less competitive for survival and root colonisation than the parent strain; therefore, greater inoculum densities are needed. • Cells are starved prior to use to pre-condition them for the low-nutrient conditions in soil.
<p>Additional information (see also colour plate on p. 536)</p>	 <p>Fig 1. Colonisation pattern of <i>P. fluorescens</i> SBW25 <i>luxCDABE</i> in the rhizosphere of a 4 day old <i>Brassica napus</i> root; (a) overlay (b) light field and (c) dark field.</p>

ID	41_Jansa_a
Author	Jansa, Jan ETH Zurich, Plant Sciences, Eschikon 33, CH – 8315 Lindau (ZH), Switzerland; jan.jansa@ipw.agrl.ethz.ch; ++41 52 3549216
Parameter	Isolation and culturing of arbuscular mycorrhizal fungi (AMF)
Soil type	any
Plant species	any plant possible to grow from seed/cutting under greenhouse conditions
System	pots
Method	Establishment and maintenance of monospecific AMF cultures
Method description	<p>Here a method is described for obtaining monospecific cultures of AM fungi from a soil. Trap cultures are employed for multiplication of native AMF in a field soil sample and then pure cultures are established by using fresh and healthy AMF spores recovered from trap cultures.</p> <p>Trap cultures are prepared from the field soil sample by either mixing the soil with a sterile inert substrate (e.g. quartz sand:Terragreen mixture 1:1) in a ratio 1 portion unsterile soil : 2-4 portions of sterile substrate mixture or by placing the unsterile soil sample (or a soil core) into the middle of the pot filled with the sterile substrate. Single plant species or a mixed plant community are planted into the trap pots and watered with deionized water with fortnightly or monthly addition of nutrient solution (e.g. 10-50 mL Hoagland nutrient solution with low P concentration – this depends on the plant species and size of the pots). After 3-6 months, sporulation of native AMF is checked (see separate method on isolation of AMF spores from soil). Fresh and healthy spores (apparently unparasitised spores with visible lipid droplets inside, preferably still with a hyphal attachment) are manually sorted under a stereomicroscope according to size, color, attachment shape etc. Single or multiple spores belonging to apparently the same AMF species are then placed on a germination root of a host plantlet (i.e. pre-cultivated leek plantlets) and planted in pots filled with cultivation substrate (preferably the native soil sterilized and recolonized with the native bacterial populations): sand: Terragreen (1:2:2). Grow the pots for 3-6 months under light nonlimiting conditions (depend on plant species, usually above 300-400 $\mu\text{mol photons m}^{-2} \text{s}^{-1}$) and temperature over 20°C during day. Then check if the inoculated AMF have developed. You should check presence of spores and also presence of root colonization. By using monosporic cultivation, the efficiency is about 10-15% for <i>Glomus</i> species and less for other AMF genera.</p>
Do's, don'ts, potential limitations, untested possibilities	<ul style="list-style-type: none"> • For some genera such as <i>Scutellospora</i> this isolation procedure might not be efficient and may need several years to complete. Choice of matching substrate and host plant may be critical (e.g. Gigasporas in general like acidic soils with pH 4-5), different AMF strains may have quite different requirements • Some AMF species such as those belonging to the genus <i>Entrophospora</i> are difficult to cultivate and this procedure might completely fail while attempting to grow them. • Do not forget to sterilize everything coming into contact with the AMF (pots, substrate, glass bowls, forceps) either in autoclave or surface-sterilize the instruments as well as the pots with ethanol.

References	<p><i>Comparison of different AMF isolation techniques - using spores separated from field soil, soil trap cultures, root samples, or transplanted seedlings:</i> Brundrett, M.; Abbott, L.K.; Jasper, D.A. 1999. Glomalean mycorrhizal fungi from tropical Australia. I. Comparison of the effectiveness and specificity of different isolation procedures. <i>Mycorrhiza</i> 8: 305-314.</p> <p><i>Analysis of nutrient availability, host plant species and time of checking AMF spore communities on the outcome of trap culturing of AMF:</i> Brundrett, M.; Jasper, D.A.; Ashwath, N. 1999. Glomalean mycorrhizal fungi from tropical Australia. II. The effect of nutrient levels and host-species on the isolation of fungi. <i>Mycorrhiza</i> 8: 315-321.</p> <p><i>Potless AMF culturing:</i> Sylvia, D.M.; Hubbell, D. 1986. Growth and sporulation of vesicular-arbuscular mycorrhizal fungi in aeroponic and membrane systems. <i>Symbiosis</i> 1: 259-267.</p> <p><i>Use of multiple plant species as host in trap cultures captures more AMF diversity:</i> Jansa, J.; Mozafar, A.; Anken, T.; Ruh, R.; Sanders, I.R.; Frossard, E. 2002. Diversity and structure of AMF communities as affected by tillage in a temperate soil. <i>Mycorrhiza</i> 12: 225-234.</p>
Links	http://invam.caf.wvu.edu/methods/cultures/cultindex.htm
Additional information	further details available from the author

ID	41_Jansa_b
Author	Jansa, Jan ETH Zurich, Plant Sciences, Eschikon 33, CH – 8315 Lindau (ZH), Switzerland; jan.jansa@ipw.agrl.ethz.ch; ++41 52 3549216
Parameter	Arbuscular mycorrhizal fungal (AMF) spores
Soil type	acid to moderately alkaline field soils with moderate SOM and clay contents
Plant species	various grasses, cereals, legumes, grassland plants
System	field soil, soil-sand mixtures
Method	Extraction of AMF spores from soil
Method description	Soil sample is first wet sieved (using water spray) through analytical sieves of defined mesh size, e.g. 700 and 40 µm to obtain spores of most of the AMF species. Several sieves could also be sandwiched so as to obtain more narrow size fractions. The soil fraction of the desired size could be repeatedly decanted over sieve (40 µm) to remove most of sand grains. Subsequently, the sample is then centrifuged (3000-5000 g max) in a density gradient of sucrose (or Percoll). For this, the soil is transferred with some water to centrifugation tubes and under-laid with high density solution (2-2.5M sucrose is commonly used). It is recommended to carefully lift the soil at the bottom of the tube with a spatula a mix a little with the sucrose, while not disturbing the density gradient. AMF spores accumulate at the interface of water and sucrose, where they could be picked up with 5mL pipette.
Do's, don'ts, potential limitations, untested possibilities	<ul style="list-style-type: none"> • It is recommended to disperse the soil either with detergent or by short blend in Waring blender (5 sec, high speed). This is particularly important for clay soils. • Exposure to sucrose over 3 min will rapidly decrease the vitality of the spores. If you are after getting healthy spores for cultivation, reduce the exposure time to sucrose as much as you can, or use low osmotic gradient such as Percoll. The sucrose will also inhibit PCR if the spores are to be used for PCR amplification, therefore transfer the spores back to the sieve and wash with plenty of tap water. • This method works very well for AMF spores with rather thin walls and lot of lipids. It only delivers more or less clean spores if the soil (or substrate) has low organic matter content. If lots of organic particles are present in soil, they usually come along with the spores in the density gradient. Manual picking of spores when purity is desired may be inevitable then. The same problem appears if the (hydroponic) substrate contains glass foam (Perlite) – there is no way to separate brittle Perlite particles from the spores. • The method does not recover all spores – there may be significant loss depending on density of centrifugation media and also on the AMF species.
References	<p><i>Original description of the wet sieving method (no gradient centrifugation):</i> Gerdemann, J.W.; Nicolson, T.H. 1963. Spores of mycorrhizal Endogone species extracted from soil by wet sieving and decanting. Transactions of the British Mycological Society 46: 235-244.</p> <p><i>Differential water-sucrose centrifugation:</i> Allen, M.F.; Moore, T.S.; Christensen, M.; Stanton, N. 1979. Growth of</p>

	<p>vesicular-arbuscular mycorrhizal and non-mycorrhizal <i>Bouteloua gracilis</i> in a defined medium. <i>Mycologia</i> 71: 666-669.</p> <p><i>Sucrose gradient centrifugation:</i> lanson, D.C.; Allen, M.F. 1986. The effects of soil texture on extraction of vesicular- arbuscular mycorrhizal fungal spores from arid sites. <i>Mycologia</i> 78: 164-168.</p> <p><i>AMF spore isolation including sucrose centrifugation, AMF identification (+other references)</i> Sieverding, E. 1991. Vesicular-arbuscular mycorrhiza management in tropical agrosystems. GTZ, Eschborn, Germany.</p> <p><i>Isolation of spores and mycelium of AMF by combination of wet sieving, flotation-bubbling, and density centrifugation methods:</i> Horn, K.; Hahn, A.; Pausch, P.; Hock, B. 1992. Isolation of pure spore and hyphal fractions from vesicular-arbuscular mycorrhizal fungi. <i>Journal of Plant Physiology</i> 141: 28-32.</p>
Links	http://www.dijon.inra.fr/bbceipm/Mychintec/Protocole/Workshop_Procedures.html
Additional information	detailed protocol available from the author

ID	41_Jansa_c
Author	Jansa, Jan ETH Zurich, Plant Sciences, Eschikon 33, CH – 8315 Lindau (ZH), Switzerland; jan.jansa@ipw.agrl.ethz.ch; ++41 52 3549216
Parameter	Arbuscular mycorrhizal fungal (AMF) mycelium
Soil type	soil-sand mixture (potting substrate for AMF experiments), sandy soils
Plant species	any
System	pot experiments, field soil
Method	Assessment of AMF mycelium length density in soil
Method description	<p>Of the numerous methods used to extract AMF hyphae from soil, the method currently in use in our lab is described. For other procedures see eg. Abbott et al. (1984) or Miller et al. (1995).</p> <p>This method describes how to quantify the development of the arbuscular mycorrhizal fungal (AMF) mycelium in the soil. It uses a repeated sampling of soil suspension and trapping the mycelium on a filter. Subsequently, this trapped mycelium is stained by Trypan Blue and quantified by gridline intersection method.</p> <p>A soil sample (approx. 5 g) is sieved through 500 and 40 µm sieves, the material from lower sieve is collected and homogenized in approx. 50mL water in Waring blender at high speed for 10 seconds. The resulting suspension is washed into a beaker, water added to 500 ml and stirred intensively for 1 minute. Then, the magnetic stirrer is stopped and small volumes (1 to 5 mL) are taken at following times: 10, 20, 30, 40, and 50 seconds. Put all the collected aliquots onto a membrane filter (with imprinted grid) in a Millipore filtration unit, apply vacuum to remove the water. Wash walls of the filtration unit with 5 mL water. Stain the filter with 2 ml of Trypan Blue solution (0.05 %) in lacto-glycerol-water for 2 min. Wash with water. Put the filter onto the slide glass, pipette a drop glycerol at two opposite sites of the filter, cover with cover slip, and observe under the microscope (magnification 200x). Record the number of intersects of AMF mycelium (4-12 µm thick, usually swellings on the mycelium present, blue color contrasting to brown to black pigmented mycelium of some saprophytic fungi) with the printed grid on the filter. Calculate total mycelial length in the sample gone through the filtration according to Newman (1965):</p> $L = (\pi \times N \times A) / (2 \times H \times W)$ <p>where: L – length of mycelium in the sample (mm / g), N – number of intersects recorded, A – observed area on the filter (mm²), H – total length of the grid lines on the observed area (mm), W – weight of the sample (aliquot passed through the filter)</p>
Do's, don'ts, potential limitations, untested possibilities	<ul style="list-style-type: none"> • This method will work particularly well for sandy substrates. It may be less useful for substrates or soils with high clay contents. Further dilution, use of high porosity filters and/or use of larger filters (using a bigger filtration apparatus) might be recommendable then. • The method has a major drawback in not discriminating between living and dead mycelium – both will stain similarly with the Trypan Blue. Estimation of the proportion of living mycelium in relation to the total mycelium is recommended (use of histochemical stains for visualization of

	enzyme activity etc.).
References	<p><i>Alternative procedures:</i> Abbott, L.K.; Robson, A.D.; De Boer, G. 1984. The effect of phosphorus on the formation of hyphae in soil by the vesicular-arbuscular mycorrhizal fungus <i>Glomus fasciculatum</i>. <i>New Phytologist</i> 97: 437-446.</p> <p>Miller, R.M.; Reinhardt, D.R.; Jastrow, J.D. 1995. External hyphal production of vesicular-arbuscular mycorrhizal fungi in pasture and tallgrass prairie communities. <i>Oecologia</i> 103: 17-23.</p> <p><i>Original description of the method for root length density estimation introducing the equation:</i> Newman, E. 1965. A method of estimation the total length of root in sample. <i>Journal of Applied Ecology</i> 3: 139-145.</p> <p><i>Critical evaluation of Newman`s method:</i> Tennant, D. 1975. A test of a modified line intersect method of estimating root length. <i>Journal of Ecology</i> 63: 995–1001.</p> <p><i>Detailed description of the method adapted for AMF hyphae length density:</i> Sylvia, D.M. 1992. Quantification of external hyphae of vesicular-arbuscular mycorrhizal fungi. In: Norris, J.R.; Read, D.J.; Varma, A.K. (eds.) <i>Methods in Microbiology</i> 24. London, UK: Academic Press, pp 53- 65.</p> <p><i>Comparison of mycelium length density with PLFA analysis of soil:</i> Ravnskov, S.; Larsen, J.; Olsson, P.A.; Jakobsen, I. 1999. Effects of various organic compounds growth and phosphorus uptake of an arbuscular mycorrhizal fungus. <i>New Phytologist</i> 141: 517-524.</p>
Links	http://www.dijon.inra.fr/bbceipm/Mychintec/Protocole/Workshop_Procedures.html
Additional information	detailed protocol could be obtained from the author

ID	41_Jansa_d
Author	Jansa, Jan ETH Zurich, Plant Sciences, Eschikon 33, CH – 8315 Lindau (ZH), Switzerland; jan.jansa@ipw.agrl.ethz.ch; ++41 52 3549216
Parameter	Arbuscular mycorrhizal fungal (AMF) infectivity
Soil type	any soil
Plant species	any natural vegetation; maize, leek, sunflower, plantain, flax and other plant species as test plants
System	biotest pots
Method	Estimation of infectious potential of AMF in soil/inoculum
Method description	<p>This method aims at quantification of the infectivity of the AMF (a sum of infectivity caused by AMF spores, mycelium fragments and colonized root fragments) in the soil by using most probable number (MPN) assay. This is a modified approach used by microbiologists for quantification of propagule numbers in a suspension of bacterial cells or like samples.</p> <p>This assay uses replicated sets of pot cultures with subsequently diluted soil inoculum. Original soil samples (either field soil or cultivation substrate) are mixed with quartz sand in a ratio 1:1. This is subsequently diluted with a sterile soil-sand 1:1 mixture in two-fold, five-fold or ten-fold dilution series covering the range of 4-5 orders of magnitude. Allow 5 to ten replicate pots for each dilution. Grow test plants for 3-12 weeks (depending on the speed of growth and AMF development in the particular plant species; shorter times will be sufficient for maize, longer times might be needed for clover or leeks). Harvest the roots and stain them with a suitable dye to visualize AMF in the roots (see separate method).</p> <p>Record presence / absence of AMF structures in each pot. This can generally be done under a stereomicroscope, but in case of doubtful structures, always prepare a slide with the suspicious roots (see separate method) and observe the sample under a compound microscope.</p> <p>The MPN value is determined from counts of positive units (those with mycorrhizae) in different dilutions. Compare the presence/absence readings with a statistical table (Alexander 1965, Woomer 1994) in order to determine the number of infective propagules in your original sample (take into account the first dilution 1:2 when calculating the propagule density in the original sample!). Confidence intervals can also be calculated (Alexander 1965).</p>
Do's, don'ts, potential limitations, untested possibilities	<ul style="list-style-type: none"> • Be careful with planning MPN experiment – with only a few soil samples to estimate the infectivity in, you may end up with many hundreds of pots in the greenhouse. • Proper mixing of the soil is absolutely critical – do not underestimate this! If the mixture is not completely homogeneous, the error may be very great.
References	<p><i>Comparison of MPN with percentage colonization method:</i> Adelman, M. J.; Morton, J.B. 1986. Infectivity of vesicular-arbuscular mycorrhizal fungi: Influence of host-soil diluent combinations on MPN estimates and percentage colonization. <i>Soil Biology & Biochemistry</i> 18: 7-13.</p> <p><i>Statistical table for converting MPN readings to propagule counts:</i> Alexander, M. 1965. <i>Methods of Soil Analysis, Part 2, Agronomy Series #9,</i></p>

	<p>ASA, Madison, Wisconsin, pp. 1467-1472.</p> <p><i>Effects of temperature and time of harvest on MPN results:</i> Wilson, J. M.; Trinick, M.J. 1982. Factors affecting the estimation of numbers of infective propagules of vesicular arbuscular mycorrhizal fungi by the most probable number method. Australian Journal of Soil Research 21: 73-81.</p> <p><i>Statistical table for converting MPN readings to propagule counts:</i> Woomer, P. 1994. Most probable number counts. In: Weaver, R. (ed.) Methods of Soil Analysis, Part 2: Microbiological and Biochemical Properties. SSSA Book Series, Madison, WI, USA, pp 59-79</p>
Links	http://invam.caf.wvu.edu/methods/assays/assayindex.htm
Additional information	detailed protocol available from author.

ID	41_Jansa_e
Author	Jansa, Jan ETH Zurich, Plant Sciences, Eschikon 33, CH – 8315 Lindau (ZH), Switzerland; jan.jansa@ipw.agrl.ethz.ch; ++41 52 3549216
Parameter	monoxenic arbuscular mycorrhizal fungal (AMF) cultures
Plant species	carrot, <i>Medicago truncatula</i> , tomato
System	in-vitro culture
Method	Establishment and maintenance of monoxenic AMF cultures
Method description	<p>This method allows establishment and maintenance of arbuscular mycorrhizal fungal (AMF) cultures under in-vitro (monoxenic) conditions, using host plant root culture (e.g., Ri T-DNA transformed carrot roots). Establishment of the root culture itself is not described here.</p> <p>AMF spores are first extracted from soil/growing media by using sucrose or Percoll gradient centrifugation – if possible, use Percoll to incur less osmotic damage on the spores. Then, the spores are cleaned from the debris by hand picking and rinsed in antibiotic solution (Streptomycin 50mg/100mL; Rifampicin 50 mg/100mL, Tetracycline 50 mg/100mL; Penicillin G 50 mg/100 mL; Neomycin sulfate 20 mg/100mL; Polymyxin B sulfate 20 mg/100 mL, 2 drops of Tween 20, subject to ultrasound for 2 min, sterilize the solution through the 0.2 µm filter) for 4 hours at the lab temperature. Use gentle shaking. Antibiotic solution is then removed by filtration in a sterile filter apparatus using a Teflon membrane filter Millipore with pore size 5µm (not less!!!). Spores are further subjected to resuspension in 1% Chloramine T solution with 1 drop of 1M HCl per 100 mL (in the filter unit) for 1 min. Wash the spores on the filter with plenty of sterile tap water (avoid deionized water – osmotic stress). Place the sterilized spores onto Petri dishes containing M medium with 0.1 M sucrose (to see the contamination easier) previously poured and cooled. Place not more that 6-8 spore for a Petri dish (close to the border) as far as possible from each other. To facilitate germination, you might need to give a few non-AMF roots of transformed carrots to the middle of the dish</p> <p>Check the spores for germination after 2-6 weeks, discard obvious contaminations, and transfer the spores with adjacent block of medium (2×2 cm) to another plate and place fresh growing roots close to the germinating hyphae of the AMF.</p>
Do's, don'ts, potential limitations, untested possibilities	<ul style="list-style-type: none"> • The quality of spores to start with is absolutely critical for success. Use only apparently healthy and fresh spores, do not store them after isolation from the substrate for more than few hours. • Most AMF will refuse to germinate on solidified media containing nutrient solution and/or sucrose. Reducing osmotically active compound as well as using droplets of liquid media instead may help. Sometimes, colonized root fragments (about 2mm in length) are more useful than spores for culture establishment, but the likelihood of them to carry internal contamination is higher compared with spores. • Different AMF species may require different host plants. Ri T-DNA transformed roots may be too fast growing for some slow AMF species, thus offering only a narrow time window to AMF to establish the colonization. Using nontransformed root cultures may be a method of

	<p>choice here.</p> <ul style="list-style-type: none"> • Because the root cultures will exhaust growth media within few months, it is important to transfer them onto new media regularly not to loose them due to senescence.
References	<p><i>Comprehensive up-to-date review:</i> Fortin, J.A.; Becard, G.; Declerck, S.; Dalpe, Y.; St-Arnaud, M.; Coughlan, A. P.; Piche, Y. 2002. Arbuscular mycorrhiza on root-organ cultures. Canadian Journal of Botany 80: 1-20.</p> <p><i>Detailed description of the method using antibiotic cocktail described above:</i> Jansa, J.; Mozafar, A.; Banke, S.; McDonald, B.A.; Frossard, E. 2002. Intra- and intersporal diversity of ITS rDNA sequences in <i>Glomus intraradices</i> assessed by cloning and sequencing, and by SSCP analysis. Mycological Research 106: 670-681.</p> <p><i>Older method using 2-antibiotic mixture for AMF spore surface sterilization:</i> Karandashov, V.; Kuzovkina, I.; Hawkins, H.-J.; George, E. 2000. Growth and sporulation of the arbuscular mycorrhizal fungus <i>Glomus caledonium</i> in dual culture with transformed carrot roots. Mycorrhiza 10: 23-28.</p>
Links	http://invam.caf.wvu.edu/methods/cultures/cultindex.htm
Additional information	author can be contacted if further details are requested

ID	41_Jansa_f
Author	Jansa, Jan ETH Zurich, Plant Sciences, Eschikon 33, CH – 8315 Lindau (ZH), Switzerland; jan.jansa@ipw.agrl.ethz.ch; ++41 52 3549216
Parameter	Root colonization by arbuscular mycorrhizal fungi (AMF)
Soil type	any
Plant species	broad range of herbaceous plants, ferns and mosses (non woody)
System	field grown plants, pot cultures, monoxenic root cultures
Method	Staining of AMF colonization in roots
Method description	The roots are first macerated (cleared) in 10% KOH for 30 – 60 min at 65-80°C in a water bath. Then they are removed from KOH, washed on a sieve, and immersed in 1M HCl for 15-60 min at room temperature before transferring to 0.05% Trypan Blue in lactoglycerol (1:1:1 w:w:w) for staining. The roots should be heated during the staining at 65-80°C for 1-2 hours. De-stain in water or glycerol for at least 2 hours before examining under the microscope.
Do's, don'ts, potential limitations, untested possibilities	<ul style="list-style-type: none"> • This is the classical staining formerly performed with Trypan Blue in lactophenol. Phenol has been recently replaced in the protocol by glycerol due to healthy risk caused by the former. Not all AMF species are well stained with Trypan Blue. Mixture of Trypan and Methylene Blue has been successfully used as well as other dyes such as Chlorazol Black E, Anilin (Cotton) Blue (however, none of those dyes stain all AMF species without exception). • Reuse of the staining solution is not recommended. It is mostly exhausted by single use and samples stained with reused solution will be faint. • For woody roots, roots containing lot of phenolics or pigments, pre-treatment with hydrogen peroxide might be needed before KOH maceration (bleaching).
References	<p><i>Original method description:</i> Phillips J & Hayman D. 1970. Improved procedures for clearing roots and staining parasitic and vesicular-arbuscular mycorrhizal fungi for rapid assessment of infection. Transactions of the British Mycological Society 55: 158-161.</p> <p><i>Procedure modification + alternative dye discussion (see separate sheet!):</i> Vierheilig, H.; Coughlan, A.P.; Wyss, U.; Piche, Y. 1998. Ink and vinegar, a simple staining technique for arbuscular- mycorrhizal fungi. Applied and Environmental Microbiology 64: 5004-5007.</p> <p><i>Review on different staining procedures, comparison of different dyes for use with different plant species:</i> Gange, A.C.; Bower, E.; Stagg, P.G.; Aplin, D.M. ; Gillam, A.E.; Bracken, M. 1999. A comparison of visualisation techniques for recording arbuscular mycorrhizal colonization. New Phytologist 142: 123-132.</p> <p><i>Fluorescence-based AMF visualisation compared with Trypan Blue staining:</i> Vierheilig, H.; Knoblauch, M.; Juergensen, K.; VanBel, A.J.E.; Grundler, F.M.W.; Piche, Y. 2001. Imaging arbuscular mycorrhizal structures in living roots of <i>Nicotiana tabacum</i> by light, epifluorescence, and confocal laser scanning microscopy. Canadian Journal of Botany 79: 231-237.</p> <p>Vierheilig, H.; Schweiger, P.; Brundrett, M. 2005. An overview of methods for the detection and observation of arbuscular mycorrhizal fungi in roots. Physiologia Plantarum 125: 393-404.</p>
Links	http://www.dijon.inra.fr/bbceipm/Mychintec/Protocole/Workshop_Procedures.html
Additional information	detailed protocol available from the author.

ID	41_Kohler
Author	Kohler, Annegret; Peter, Martina; Duplessis, Sébastien; Martin, Francis* UMR INRA-UHP "Interactions Arbres/Micro-Organismes" INRA-Nancy, 54280 Champenoux (France) *corresponding author: fmartin@nancy.inra.fr, ++33 383 39 40 80
Parameter	Synthesis of ectomycorrhiza
Plant species	Poplar
System	Artificial growth media in Erlenmeyer flasks
Method	Culture in perlite
Method description	250 ml Erlenmeyer flasks were filled until the 200 ml mark with perlite. After addition of 30 ml liquid modified Melin Norkrans medium (MMN), the erlenmeyer flasks were autoclaved. Ectomycorrhizal fungi were pre-cultured on agar plates containing MMN medium. Small pieces of mycelium-covered agar were added under sterile conditions to the flasks. The flasks were then kept in a controlled environment growth chamber (17h photoperiod at $200 \mu\text{mol m}^{-2} \text{s}^{-1}$ at 25°C). At the same time poplar cuttings (INRA clone 717-1B4) were placed in glass tubes containing 15 ml of Murashige & Skoog (MS) agar and transferred to the growth chamber as well. About one month later the well-rooted poplar plantlets were transferred under sterile condition into the Erlenmeyer flask containing perlite covered with mycelium. Then, the flasks were placed back into the growth chamber and checked after 3 weeks for mycorrhiza development.

Melin Norkrans medium (MMN) medium

	Stock solution	Agar plates for fungal pre-culture	Liquid medium for Erlenmeyer flasks
KH_2PO_4	50g/l	10 ml/l	20ml/l
$(\text{NH}_4)_2\text{HPO}_4$	25g/l	10 ml/l	20ml/l
$\text{CaCl}_2, 2 \text{H}_2\text{O}$	5g/l	10 ml/l	20ml/l
NaCl	2.5g/l	10 ml/l	20ml/l
$\text{MgSO}_4, 7\text{H}_2\text{O}$	15g/l	10 ml/l	20ml/l
Thiamine	1g/l	100 μl	100 μl
$\text{FeCl}_3, 6 \text{H}_2\text{O}$	10g/l	100 μl	200 μl
Glucose	-	10g/l	1.25g/l
Malt extract	-	-	5g/l
Agar	-	15g/l	

- Adjust pH to 5.5

Culture Media for poplar rooting; Murashige & Skoog (MS) 1/2

Stock solution:	/ 1 l	/ 500 ml	/ 250 ml
Macro-elements	50 ml	25 ml	12.5 ml
Oligo-elements	1 ml	0.5 ml	0.25 ml
Fe	10 ml	5 ml	2.5 ml
Myo-inositol	10 ml	5 ml	2.5 ml
Saccharose	20 g	10 g	5 g
H_2O	910 ml	465 ml	230 ml
pH	5.9 - 6.0		
Agar	7 g	3.5 g	1.75 g
<i>After autoclaving:</i>			
Vitamines	10 ml	5 ml	2.5 ml
L-glutamine 20 g/l	10 ml	5 ml	2.5 ml

- autoclave at 120°C 20 min
- add 10-12 ml / tube (sterilized in advance)

Preparation of the stock solutions

a) Macro-elements (10 x) (All chemicals on the shelf by the balance.)

	/ 1000 ml
NH ₄ NO ₃	16.5 g
KNO ₃	19 g
CaCl ₂ x 2 H ₂ O	4.4 g
MgSO ₄ x 7 H ₂ O	3.7 g
KH ₂ PO ₄	1.7 g

- Autoclave for 20 min at 120°C. Store in room temperature, keep sterile.
- Add 100 ml of the solution per 1 l of final medium.

b) Oligo-elements (1000 x)

	/ 100 ml
H ₃ BO ₃	620 mg
MnSO ₄ x H ₂ O	1690 mg
ZnSO ₄ x 7H ₂ O	1060 mg
KI	83 mg
Na ₂ MoO ₄ x 2 H ₂ O	25 mg
CuSO ₄	1.6 mg
CoCl ₂ x 6H ₂ O	2.5 mg

- Autoclave for 20 min at 120°C. Store in room temperature, keep sterile.
- Add 1 ml of the solution per 1 l of final medium.

c) Iron (100 x = 0,01 M)

	/ 200 ml
Ethylendiaminetetraacetic acid iron (III)- monosodium salt (C ₁₀ H ₁₂ FeN ₂ NaO ₈ ; MW=367.05)	0.8 g

- Autoclave for 20 min at 120°C. Store in room temperature, keep sterile.
- Add 10 ml of the solution per 1 l of final medium → 0,1 mM (40 mg/l)

d) Myo-inositol (100 x = 0,06 M)

	/ 200 ml
Myo-inositol (i-inositol, meso-inositol; MW = 180.2)	2 g

- Autoclave for 20 min at 120°C. Store in room temperature, keep sterile.
- Add 10 ml of the solution per 1 l of final medium → 0,6 mM (100 mg/l)

e) B-vitamins (100 x)

	/ 500 ml
Nicotinic acid	50 mg
Pyridoxine hydrochloride	50 mg
Thiamine hydrochloride	50 mg
Ca-pantotenate	50 mg
L-cysteine chlorohydrate	50 mg
Biotine (5 mg / 50 ml NaOH + H ₂ O)	5 ml

- Biotine: add 10 drops of NaOH and adjust to 50 ml with distilled H₂O.
- Filter sterilize with 0.22 µm filter, divide into sterile plastic tubes, 5 or 10 ml per tube, and store in the freezer.
- Add 10 ml of the solution per 1 l of final medium.

Used vitamins:

- Nicotinic acid (Niacin, Pyridine-3-carboxylic acid), C₆H₅NO₂, MW 123.1, [59-67-6], Sigma N-0765
- Pyridoxine (Pyridoxol, Vitamin B₆) hydrochloride, C₈H₁₁NO₃ x HCl, MW 205.6, [58-56-0], Sigma P-8666
- Thiamine (Vitamin B₁) hydrochloride, C₁₂H₁₇CIN₄OS x HCl, MW 337.3, [67-03-8], Sigma T-4625
- Ca D(+)-pantothenate (D(+)-Pantothenic acid calcium salt,) (C₉H₁₆NO₅)₂Ca, MW 476.54, Prolabo 22 395.137
- L-cysteine hydrochloride monohydrate, C₃H₇NO₂S x HCl x H₂O, MW 175.6, [7048-04-6] Sigma C-4820
- D-Biotin (Vitamin H), MW 244.3, Sigma B-4501

f) L-glutamine (100 x = 0,14 M)

	/ 200 ml
L-glutamine (C ₅ H ₁₀ N ₂ O ₃ , MW = 146.1)	4 g

- Filter sterilize with 0.22 µm filter, divide into sterile plastic tubes, 5 or 10 ml per tube, and store in the freezer.
- Add 10 ml of the solution per 1 l of final medium → 1.4 mM (200 mg/l)

ID	41_Olsson
Author	Pål Axel Olsson Department of Microbial Ecology, Ecology Building, Lund University, SE-223 62 Lund, Sweden pal_axel.olsson@mbioekol.lu.se; ++46 46 2229614
Parameter	Quantification of AM fungal signature lipids
Soil type	Any
Method	Fatty acid analysis
Method description	Lipids are extracted from soil (1-10 g), roots (10-100 mg) or mycelium (1-2 mg) in a one-phase chloroform:methanol:citrate buffer mixture. Lipid extracts are separated from soil pellets after centrifugation at 3000 g (not needed for mycelium or root samples). The lipid phase is collected after splitting the phases. The lipids are fractionated into neutral lipids, glycolipids and phospholipids on silica columns (Varian) by eluting with chloroform, acetone and methanol, respectively. The fatty acid residues of the neutral lipids and phospholipids are transformed into free fatty acid methyl esters (FAMES) by a mild alkaline methanolysis, and subsequently identified and quantified by GC-MS (gas chromatography followed by mass spectrometry).
Do's, don'ts, potential limitations, untested possibilities	Fatty acid 16:1 ω 5 in particular can be used as a signature compound for the detection and quantification of AM fungal growth in roots and soil. It is rare in other fungi but the dominant fatty acid in most AM fungi except <i>Gigaspora</i> spp. Due to the high neutral lipid content of AM fungi, 16:1 ω 5 from the neutral lipid or total lipid fraction is a very sensitive signature. 16:1 ω 5 from the phospholipid fraction (PLFA) can only be used as a signature in controlled systems (with non-mycorrhizal controls) due to the high background of PLFA 16:1 ω 5 originating from bacteria. ¹³ C-labelling combined with compound specific isotope ratio mass spectrometry is a way to track carbon flow from plants to AM fungi by estimating the ¹³ C-enrichment in NLFA 16:1 ω 5.
References	Graham, J.H. ; Hodge, N.C. ; Morton, J.B. 1995. Fatty-acid methyl-ester profiles for characterization of glomalean fungi and their endomycorrhizae. Appl. Environ. Microbiol. 61: 58-64 Olsson, P.A.; Baath, E.; Jakobsen, I. ; Soderstrom, B. 1995. The use of phospholipid and neutral lipid fatty-acids to estimate biomass of arbuscular mycorrhizal fungi in soil. Mycol. Res. 99 : 623-629 Olsson, P.A. ; Baath, E; Jakobsen, I. 1997. Phosphorus effects on the mycelium and storage structures of an arbuscular mycorrhizal fungus as studied in the soil and roots by analysis of fatty acid signatures. Appl. Environ. Microbiol. 63: 3531-3538 Olsson, P.A. 1999. Signature fatty acids provide tools for determination of the distribution and interactions of mycorrhizal fungi in soil. FEMS Microbiol. Ecol. 29: 303-310. Olsson, P.A.; Wilhelmsson. P. 2000. The growth of external AM fungal mycelium in sand dunes and in experimental systems. Plant Soil 226: 161-169. Olsson, P.A. ; Hansson, M.C. ; Burleigh, S.H. 2006. Effect of P availability on temporal dynamics of carbon allocation and Glomus intraradices high-affinity P transporter gene induction in arbuscular mycorrhiza. Appl. Environ. Microbiol. 72: 4115-4120.

ID	41_Puglisi
Author	Puglisi, E.; Capri E. Istituto di Chimica Agraria ed Ambientale, UCSC, Via Emilia Parmense 84, 29110 Piacenza-I; edoardo.puglisi@unicatt.it; ++39 0523599345
Parameter	Sterols, Phospholipid Fatty Acids (PLFAs)
Soil type	Agricultural and forest soils
System	microcosm
Method	Characterization of soil living and dead biomass origin and structure
Method description	<i>PLFA</i> Phospholipids are extracted from soil with a buffered chloroform-methanol solution; the chloroform phase is adsorbed on a solid phase extraction Silica column (SPE-SI) and washed with chloroform, acetone and methanol to obtain respectively the neutral, glyco- and phospholipid fractions and purified by a solid-phase extraction (SPE) system. A mild alkaline methanolysis is carried out on the phospholipids fraction and structurally different fatty acids methyl esters are separated by means of different SPE systems and analysed with GC-MS. <i>Sterols</i> Both free and conjugated sterols are extracted with methanol. The determination of cholesterol, β -sitosterol, coprostanol and other 5β -stanols is made by GLC/MS after silylation with pyridin, N,O-bis-(trimethylsilyl) trifluoroacetamide, esamethyldisilazane and trimethyl chlorosilane in a 0.2:1:2:1 ratio. The reagent excess is evaporated under a stream of nitrogen, 1 ml of isooctane is added and the remaining solution is injected in GLC/MS. Ergosterol analysis is carried out by HPLC without prior silylation, because for this compound in GLC/MS some interference peaks can be found
Do's, don'ts, potential limitations, untested possibilities	<i>PLFA:</i> <ul style="list-style-type: none"> Phospholipid fatty Acids (PLFAs) analysis is a powerful and responsive tool for soil status evaluation. A soil alteration index based on soil PLFA composition has been recently developed by our research group (Puglisi et al., 2005). In order to achieve a good detection limit, at least 10 g of soil should be analysed. <i>Sterols:</i> Sterols analysis is an important tool for characterizing biomass and other organic pools, as different classes of organisms have different sterols pattern. Cholesterol, β -sitosterol and ergosterol are representative of the animal, vegetal and fungal kingdoms. 5β -stanols are produced in the intestinal tract of most higher animals and are markers of fecal pollution.
References	<i>PLFA:</i> Zelles, L. 1996. Fatty acids patterns of microbial phospholipids and lipopolysaccharides. In: Schinner, F.; Ohlinger, R.; Kandeler, E.; Margesin, R. (eds.) Methods in Soil Biology. Springer-Verlag, Berlin, pp 80-93. Puglisi, E.; Nicelli, M.; Capri, E.; Trevisan, M.; Del Re A.A.M. 2005. A soil alteration index based on phospholipids fatty acids. Chemosphere 61:1548-1557. <i>Sterols:</i> Puglisi, E.; Nicelli, M.; Capri, E.; Trevisan, M.; Del Re A.A.M. 2003. Cholesterol, β -sitosterol, ergosterol and coprostanol in agricultural soils. Journal of Environmental Quality 32: 466-471.
Additional Information	a more detailed protocol on the methods is available upon request from the authors

ID	41_Rothballer
Author	Rothballer, Michael; Hartmann, Anton GSF-Institute of Soil Ecology, Department of Rhizosphere Biology, Ingolstädter Landstr. 1, D-85764 Neuherberg/Munich, Germany rothballer@gsf.de; ++49 89 3187 3534; anton.hartmann@gsf.de
Parameter	<i>In situ</i> detection of bacterial gene expression in the rhizosphere
Plant species	cereals, tomato
System	monoxenic quartz sand system
Method	translational promoter fusion
Method description	The promoter of the respective gene is fused to a <i>gfp</i> gene so that the start codon of the analyzed gene is replaced by the start codon of the <i>gfp</i> gene. The construct is cloned into a shuttle vector and transferred to the bacterial cells by conjugation. With this method the intensity of GFP-fluorescence is a measure of promoter activity and thereby represents the expression levels of the analyzed gene. Detection of fluorescent cells is accomplished by a confocal laser scanning microscope.
Do's, don'ts, potential limitations, untested possibilities	<ul style="list-style-type: none"> • It is important to use a shuttle vector which is stable in target cells without antibiotic pressure, as antibiotics are hard to apply <i>in situ</i>. • This will work well in monoxenic (e.g. sterile quartz sand with inoculum) systems but in soil a plasmid borne GFP marker is very instable and in most cases a chromosomal GFP labeling is necessary. Nevertheless the detection of GFP in soil is difficult or sometimes impossible with a conventional laser scanning microscope due to the strong autofluorescence of most soils. In this case a wavelength specific detector has to be used, which allows identification of characteristic emission spectra of fluorescent dyes and digital separation from autofluorescence. • The instable <i>gfp</i> variant ASV is best suited for most promoter studies but does not result in detectable fluorescence in some bacteria (e.g. <i>Azospirillum brasilense</i>). As an alternative a stable <i>gfp</i> variant (<i>mut3</i>) can be used.
References	<p><i>Description of or references for all methods, example of results with interpretation:</i></p> <p>Andersen, J.B.; Sternberg, C.; Kongsbak, P.L.; Petersen, B.S.; Givskov, M.; Molin, S. 1998. New Unstable Variants of green fluorescent protein for studies of transient gene expression in bacteria. Appl. Environ. Microbiol. 64: 2240-2246.</p> <p>Brandl, M.T.; Quinones, B.; Lindow, S.E. 2001. Heterogeneous transcription of an indole acetic acid biosynthetic gene in <i>Erwinia herbicola</i> on plant surfaces. Proc. Natl. Acad. Sci. USA 98: 3454-3459.</p> <p>Egener, T.; Hurek, T.; Reinhold-Hurek, B. 1998. Use of green fluorescent protein to detect expression of <i>nif</i> genes of <i>Azoarcus</i> sp. BH72, a grass-associated diazotroph, on rice roots. Mol. Plant Microbe Interact. 11: 71-75.</p> <p>Matz, M.V.; Fradkov, A.F.; Labas, Y.A.; Savitsky, A.P.; Zaraisky, A.G.; Markelov, M.L.; Lukyanov, S.A.; 1999. Fluorescent proteins from nonbioluminescent <i>Anthozoa</i> species. Nature Biotechnology 17: 969-973.</p> <p>Riedel, K.; Hentzer, M.; Geisenberger, O.; Huber, B.; Steidle, A.; Wu, H.; Høiby, N.; Givskov, M.; Molin, S.; Eberl, L. 2001. <i>N</i>-Acylhomoserine-lactone-</p>

mediated communication between *Pseudomonas aeruginosa* and *Burkholderia cepacia* in mixed biofilms. *Microbiology* 147: 3249–3262.

Rothballer, M.; Schmid, M.; Hartmann, A. 2003. *In situ* localization and PGPR-effect of *Azospirillum brasilense* strains colonizing roots of different wheat varieties. *Symbiosis* 34: 261-279.

Rothballer, M.; Schmid, M.; Fekete, A.; and Hartmann, A. 2005. Comparative *in situ* analysis of *ipdC-gfpmut3* promoter fusions of *Azospirillum brasilense* strains Sp7 and Sp245. *Environ. Microbiol.* 7(11): 1839-1846

Steidle, A.; Sigl, K.; Schuegger, R.; Ihring, A.; Schmid, M.; Gantner, S. 2001. Visualization of *N*-acylhomoserine lactone-mediated cell-cell communication between bacteria colonizing the tomato rhizosphere. *Appl. Environ. Microbiol.* 67: 5761-5770.

Additional information:

In recent years the green fluorescent protein (GFP) has become a valuable molecular marker for *in situ* monitoring of bacteria or gene expression on a single cell level. Detection of GFP marked cells is possible without any manipulation or chemical treatment of the sample, which is especially important, when the localization of bacteria in an unaltered natural habitat like roots is desired (Rothballer et al. 2003). Currently a large number of modified proteins with different fluorescence properties are available (Andersen et al. 1998, Matz et al. 1999). Fluorescent proteins with emission in blue, cyan, green, yellow, red and dark red are available (e.g. BD Biosciences Clontech, Heidelberg, Germany; www.clontech.com). The method has been applied for studying e.g. *ipdC* expression of several rhizosphere bacteria *in situ* (e.g. Rothballer et al. 2005, Brandl et al. 2001, Egner et al. 1998) and for visualization of quorum sensing (e.g. *N*-acyl homoserine lactones) in the rhizosphere of tomato (Steidle et al. 2001) or in mixed biofilms in the lungs of cystic fibrosis patients (Riedel et al. 2001). For quantitative analysis sophisticated evaluation software is needed, which enables the processing of three-dimensional data produced with a confocal laser scanning microscope. This kind of software is currently being developed but not available to date.

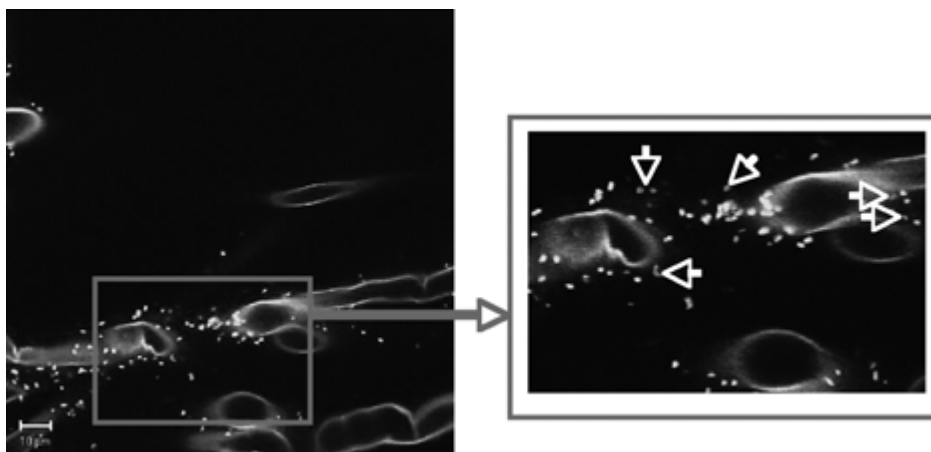

Fig. 1: Rhizosphere bacteria stained with DNA binding dye SYTO orange 81 on wheat roots; AHL production of *Acidovorax* sp. N35 (red cells) is indicated by *gfp* expression of the sensor strain *S. liquefaciens* MG44 (yellow cells: combination of GFP and red fluorescing SYTO dye), which contains the sensor construct pBAH9 (Huber, unpublished). Picture by Brigitte Hai (see also colour plate on p. 536).

ID	41_Schweiger_a
Author	Schweiger, Peter ¹⁾ ; Sainz, Maria J. ²⁾ ¹⁾ Institute of Soil Research, University of Life Sciences, Peter Jordan Straße 82, A-1190 Vienna, Austria; peter.schweiger@boku.ac.at ²⁾ Departamento de Producción Vegetal, Universidad de Santiago de Compostela, Campus Universitario s/n, E-27002 Lugo, Spain + 34 982 252231; mjsainz@lugo.usc.es
Parameter	Colonisation of roots by arbuscular mycorrhizal (AM) fungi
Plant species	Most Angiosperms, many Pteridophytes, some Gymnosperms
System	Roots
Method	The gridline intersection method
Method description	<p>Roots are gently washed free of soil. Samples of 0.5 to max 2 g are cleared in hot 10 % KOH. Length of clearing depends on the roots and the clearing temperature. Roots of many herbaceous plants (eg clovers, grasses, etc) are satisfactorily cleared after 15 to 20 min in near-boiling KOH. Roots are thoroughly washed with tap water and stained with a suitable dye such as eg. 0.05 % cotton blue in lactoglycerol (lactic acid:glycerol:water=1:1:1; see other method sheet). Staining should last for 5 to 10 minutes at 60 to 80 °C. Excess stain is washed off the roots and the roots are then kept in 50 % glycerol until examination.</p> <p>For the quantification of root colonisation, the stained roots are evenly distributed in a Petri dish, in the bottom of which grid lines have been drawn with a needle. Intersects between roots and grid lines are counted under a dissecting microscope at 20 to 50 x magnification. Mycorrhizal and non-mycorrhizal intersects are counted at the same time but in separate columns. The percentage of root length colonised by AM fungi is calculated as the ratio between number of mycorrhizal counts divided by total counts.</p> <p>Root length in the dish is calculated based on the equation of Newman (1966): $N * \pi * A / (2 * L)$, where N is total number of counts, A is the area of the dish and L is the total length of the grid lines.</p>
Do's, don'ts, potential limitations, untested possibilities	<ul style="list-style-type: none"> • Weight of root samples should ideally not exceed 1-2 g. • <i>Cut roots into 2-4 cm long segments before clearing.</i> • Root clearing is very fast in an autoclave – the time of clearing has to be adjusted accordingly (often not more than 10 minutes). • Darkly pigmented roots require post-clearing bleaching with hydrogen peroxide. • A minimum of 100 intersection points per sample has to be counted to get an accurate estimate of the degree of AM root colonisation. • To determine colonisation by AM fungal species that do not stain well or in pigmented roots, slides from randomly selected subsamples of roots should be made and observed under a compound microscope (method by McGonigle et al, 1990).
References	Ambler, J.R.; Young, J.L. 1977. Techniques for determining root length infected by vesicular-arbuscular mycorrhizae. Soil Science Society of America Journal 41: 551-556.

	<p>Brundrett, M.; Bougher, N.; Dell, B.; Grave, T.; Malajczuk, N. 1996. Working with Mycorrhizas in Forestry and Agriculture. Australian Centre for International Agricultural Research Monograph 32, Canberra, 374 pp.</p> <p><i>Giovannetti, M.; Mosse, B. 1980. An evaluation of techniques for measuring vesicular-arbuscular infection in roots. New Phytologist 84: 489-500.</i></p> <p>McGonigle, T.P.; Miller M.H.; Evans, D.G.; Fairchild, G.L.; Swan, J.A. 1990. A new method that gives an objective measure of colonization of roots by vesicular-arbuscular mycorrhizal fungi. <i>New Phytologist 115: 495-501.</i></p> <p>Newman, E.I. 1966. A method of estimating the total length of root in a sample. <i>Journal of Applied Ecology 3: 139-145.</i></p> <p>Phillips, J.M.; Hayman D.S. 1970. Improved procedures for clearing roots and staining parasitic and vesicular-arbuscular mycorrhizal fungi for rapid assessment of infection. <i>Transactions of the British Mycological Society 55: 158-161.</i></p>
Links	<p>http://mycorrhiza.ag.utk.edu/mstain.htm</p> <p>http://mycorrhiza.ag.utk.edu/mmeasure.htm</p> <p>http://www.ffp.csiro.au/research/mycorrhiza/download/fig4_3.pdf</p> <p>http://www.ffp.csiro.au/research/mycorrhiza/download/fig4_4.pdf</p>
Additional information	<p>The gridline intersection method is most frequently used to estimate AM root colonisation. Other methods have been proposed. For instance, McGonigle et al. (1990) assess AM colonisation in root fragments mounted on slides and observed under a compound microscope, recording the absence or presence of AM fungi (or their different structures) in randomly selected field of view and cross-hair positions.</p>

ID	41_Schweiger_b
Author	Schweiger, P. Institute of Soil Research, University of Life Sciences, Peter Jordan Straße 82, A-1190 Vienna, Austria; ++43 1 47654 3127; peter.schweiger@boku.ac.at
Parameter	Visualisation of ecto- and arbuscular mycorrhizal morphology
Method	Laser Scanning Confocal Microscopy (LSCM)
Method description	Laser Scanning Confocal Microscopy is used to image fluorescent structures with a much higher three-dimensional resolution than possible with conventional light and epifluorescent microscopical techniques. Both fresh or fixed samples can be visualised. Samples have either to be autofluorescent or are stained with appropriate fluorochromes. Suitable fluorochromes for: <ul style="list-style-type: none"> • AM: acid fuchsin, WGA+FITC • EM Mycelium: acid fuchsin, congo red, LYCH, acriflavine • EM root: acid fuchsin, acriflavine, xanthene dyes Even lightly pigmented samples may have to be cleared (with eg KOH) prior to staining for satisfactory LSCM imaging.
Do's, don'ts, potential limitations, untested possibilities	<ul style="list-style-type: none"> • For the 3D reconstruction of images, samples have to be examined for distortion along the z-axis. Corrections may be necessary, due to refractive index mismatches between immersion medium of the objective lens, mounting medium and sample tissue. Fluorescent beads of known diameter are available for that purpose. • For visualisation of thicker tissues, the gain and PMT signal amplification settings should be adjusted progressively with increasing depth of imaging. • Xanthene dyes may be useful for fixed and embedded samples only. • Numerous other, so far untested dyes may prove useful such as eg calcofluor (if the available LSCM has a UV band). • Samples stained with Chlorazol black E (for conventional light microscopy) may be imaged quite satisfactorily in transmission light mode.
References	Comandini, O. ; Pacioni, G.; Rinaldi, A.C. 1998. Fungi in ectomycorrhizal associations of silver fir (<i>Abies alba</i> Miller) in Central Italy. <i>Mycorrhiza</i> 7: 323-328 Dickson, S. ; Schweiger, P. ; Smith, F.A. ; Soderstrom, B. ; Smith, S. 2003. Paired arbuscules in the Arum-type arbuscular mycorrhizal symbiosis with <i>Linum usitatissimum</i> . <i>Can. J. Bot.</i> 81: 457-463. Melville, L.; Dickson, S. ; Farquhar, M.L. ; Smith, S.E. ; Peterson, R.L. 1998. Visualization of mycorrhizal fungal structures in resin embedded tissues with xanthene dyes using laser scanning confocal microscopy. <i>Can. J. Bot.</i> 76: 174-178 Schelke, M. ; Ursic, M. ; Farquhar, M.L. ; Peterson, R.L. 1996. The use of laser scanning confocal microscopy to characterize mycorrhizas of <i>Pinus strobus</i> L and to localize associated bacteria. <i>Mycorrhiza</i> 6 : 431-440 Schweiger, P.; Rouhier, H.; Soderstrom, B. 2002. Visualisation of ectomycorrhizal rhizomorph struct. using laser scanning confocal microsc. <i>Mycol. Res.</i> 106: 349-354. Vierheilig, H.; Knoblauch, M.; Juergensen, K.; VanBel, A.J.E.; Grundler, F.M.W.; Piche, Y. 2001. Imaging arbuscular mycorrhizal structures in living roots of <i>Nicotiana tabacum</i> by light, epifluorescence, and confocal laser scanning microscopy. <i>Canadian Journal of Botany</i> 79: 231-237.
Links	<i>Example for LSCM:</i> http://www.vcbio.sci.kun.nl/eng/image-gallery/technik/confocal/ Dyes are available from suppliers of standard analytical chemicals.

ID	41_Takacs_a
Author	Takacs, Tunde Research Institute for Soil Science and Agricultural Chemistry HAS, Herman O. ut 15, H-1022 Budapest, Hungary; takacs@rissac.hu; ++36-1- 2243-617
Parameter	Single spore inoculum production of Arbuscular Mycorrhizal Fungi
Soil type	Sterilised, γ - irradiated soil (25 kGy kg ⁻¹ dry soil) and sand mixture (1:1 or 2:1 v/v)
Plant species	“trap-plant” species with a known susceptibility to AMF colonisation, such as <i>Plantago lanceolata</i> , <i>Linum usitatissimum</i> , or white clover (<i>Trifolium repens</i>)
System	Pot culture
Method	Single Spore Culture
Method description	AMF spores are separated from the soil samples by the wet-sieving and decanting technique of Gerdemann and Nicolson (1963). The intact and matured spores are selected under a binocular microscope on the basis of spore morphology. Potential candidates of the spores for the propagation as “single spore strains” can be selected and based on morphological characterisation separated in different groups. Preferably 1 mature spore can be placed onto the surface of 1 w/v % water agar (Difco bacto-agar), poured into a glass funnel (land spout) with a 6 cm diameter and with a stalk parameter of 2 x 2 cm (length x diameter). The intact and living spore is placed onto the surface of the agar medium, which protects it against drought-stress. The funnel with spore is put on a layer of growth medium in 1-l plastic pot. The AMF spore is covered with a soil and sand mixture, which is moistened and surface sterilized seeds are placed on them. The seeds and the area around the funnel are also covered by soil:sand growth substrate. Hosts of AMF are grown for three or four months in a climatic chamber under controlled conditions. After the assessment of AMF colonisation of the infected root samples, the strain, propagated by this way can be used as starter, primary inoculums of the AM fungi for further upscaling procedure with higher volume.
Do's, don'ts, potential limitations, untested possibilities	The funnel technique (Menge and Timmer, 1982) is commonly used to inoculate plants in the greenhouse. The funnel forces the roots to grow close to the single spores and assures AMF infection in case only one spore is used. In this modified technique, the funnel and agar slant method (Hepper, 1981) are combined which results in more efficient inoculation than other procedures. In this methodology the pot cultures can be started with single spores, which may result in propagation of a known AMF species. The pre-germination of the spores on a membrane filter square seems not to be necessary. Spores can be disinfected by using 0.5% NaOCl or other techniques (Budi et al. 1999, Watrude 1982). The germination rate of the spores and the AMF root colonization were however decreased by surface sterilisation. In this study the clover (<i>Trifolium repens</i>) proved to be the best suited plant species.
References	Budi, S.W.; Blal, B.; Gianinazzi, S. 1999. Surface-sterilization of <i>Glomus mosseae</i> sporocarps for studying endomycorrhization <i>in vitro</i> . Mycorrhiza 9: 65-68.

	<p>Gerdemann, J.W.; Nicolson, T.H. 1963. Spores of mycorrhizal Eendogone species extracted from soil by wet sieving and decanting. <i>Trans. Br. Mycol. Soc.</i>, 46: 235-244.</p> <p>Hepper, C.M. 1981. Techniques for studying the infection of plants by vesicular-arbuscular mycorrhizal fungi under axenic conditions. <i>New Phytol.</i> 88: 641-647.</p> <p>Menge, J. A.; Timmer, L.W. 1982. Procedures for inoculation of plants with vesicular-arbuscular mycorrhizae in the laboratory, greenhouse, and field. In: Schenck, N.C. (ed.) <i>Methods and Principles of Mycorrhizal Research</i>, pp. 59-68.</p> <p>Takács, T.; Vörös, I. 2003. Occurrence of indigenous arbuscular mycorrhizal fungi in several agro-ecosystems and monospore AMF strains production. In: <i>Abstracts of the 14 th International Congress of the Hungarian Society for Microbiology</i>. Balatonfüred, Hungary, p. 23</p> <p>Watrud, L.S. 1982. Spore germination and axenic culture of Endo-mycorrhizae. Schenck, N.C. (ed.) <i>Methods and Principles of Mycorrhizal Research</i>, pp. 81-83.</p>
Links	Further publications at www. taki.iif.hu/soilbio/soilbiol.html
Additional information	Detailed protocol available from the author

ID	41_Takacs_b
Author	Takacs, Tunde; Vörös, Ibolya Research Institute for Soil Science and Agricultural Chemistry HAS, Herman O. ut 15, H-1022 Budapest, Hungary; takacs@rissac.hu; ++36-1- 2243-617
Parameter	Quality control of Arbuscular Mycorrhizal Fungi inoculum
Soil type	any
Plant species	AMF host plants
System	plant root system
Method	Quantification of mycorrhizal propagules density
Method description	To get mycorrhizal plants, host plants are grown for three months in pots (with 600 g soil per pot, in three replicates) in a growth chamber, under controlled climatic conditions (temperature between 25 and 17 °C, with a 18 h/6 h light/dark period). The starter 3 w /w % AMF inoculum is air-dried, homogenised and sieved prior to use. The root colonisation and infection units in the inoculum are determined in cleared root fragments, stained with an appropriate stain (see other methods sheet). The frequency (F%) and the quantity of the arbuscules (a%, A%) in the roots of the host are estimated by rating the density of infection on 30 1-cm root segments using the five class system developed by Trouvelot et al. (1986). Number of the discrete infection units (N _{IU}) per 1-cm root fragments in a sample is counted under a dissecting microscope (in 30 replicates). A water suspension is made in parallel from 2 grams of homogenised inoculum and 30 ml distilled water. The suspension is filtered (we found Schleicher & Schuell 589 ¹ Black ribbon or equivalent to be the most suitable) under vacuum in 2-3 ml portions. Under the dissecting microscope the root lengths (RL) are measured by the gridline intersect method (see other method sheet) in five replicates. The propagule density of 100 g AMF inocula can be calculated from the total root length (TRL) and infection units per 1 cm root sample (N _{IU} x TRL).
Do's, don'ts, potential limitations, untested possibilities	The number of infection units in an AMF inoculum depends on the number of potentially infective propagules such as eg. spores, colonized root fragments, vesicles and mycelial fragments which can lead to root colonization under optimal conditions (Takács et al. 2006). This is a direct assay resulting in a 1:1 correspondence between number of infective propagules and number of infection units. The great advantage of this assay is that irregular dilutions of inocula can be used. In this presented method for quantifying infectivity of AMF inocula the Infection Unit Method (Franson and Bethlenfalvay, 1989) and AMF colonization measurement by the five-class system (Trouvelot et al., 1986) are combined.
References	Franson, R.L.; Bethlenfalvay, G.J. 1989. Infection unit method of vesicular-arbuscular mycorrhizal propagule determination. <i>Soil. Sci. Soc. Am. J.</i> 53:754-756. Phillips, J.M.; Hayman, D.S. 1970. Improved procedures for clearing roots and staining parasitic and VAM fungi for rapid assessment of infection. <i>Trans. Brit. Mycol. Soc.</i> 55: 158-161. Takács, T.; Vörös, I.; Biró, I. 2006. Response of arbuscular mycorrhizal fungi infectiveness to soil nitrogen supply. <i>Cereal Res. Comm.</i> 34:319-322. Trouvelot, A.; Kough, J.L.; Gianinazzi-Person, V. 1986. Measure du taux de mycorrhization VA d'un système racinaire. In: Gianinazzi-Person, V.; Gianinazzi, S. (eds.) <i>Physiological and genetical aspects of mycorrhizae</i> . INRA. pp. 217-221.
Links	Further publications at www.taki.iif.hu/soilbio/soilbiol.html
Additional Inf.	Detailed protocol available from the author

ID	41_Vanderleyden_a
Author	Vanderleyden, J. Centre of Microbial and Plant Genetics, Kasteelpark Arenberg 20, B-3001 Heverlee, Belgium Jozef.Vanderleyden@agr.kuleuven.ac.be; ++32 16 32 96 79
Parameter	Study of bacterial growth over a long period of time
System	Laboratory test with cultivated bacteria
Method	BioscreenC
Method description	Overnight cultures of strains of interest are diluted in 10 mM MgSO ₄ to an absorbance at 595 nm (A ₅₉₅) of 0.3 (dilution approximately 10-fold). Subsequently, these cultures are diluted 10-fold after which 295 µl of growth medium is inoculated with 5 µl of the obtained bacterial suspension (total dilution ~ 6000 fold). Bacteria are grown while the absorbance is measured automatically each 30 min during at least 6 days in a BioscreenC (Labsystems Oy). For each time point, the average optical density is calculated from five independent measurements.
Do's, don'ts, potential limitations, untested possibilities	The development of growth curves using the BioscreenC cannot be combined with sampling.
References	<i>Example on results and interpretation with rhizobial strains:</i> Daniels, R.; De Vos, D.E.; Desair, J.; Raedschelders, G.; Luyten, E.; Rosemeyer, V.; Verreth, C.; Schoeters, E.; Vanderleyden, J.; Michiels, J. 2002. The <i>cin</i> quorum-sensing locus of <i>Rhizobium etli</i> CNPAF512 affects growth and symbiotic nitrogen fixation. <i>Journal of Biological Chemistry</i> 277: 426-430. Snoeck, C.; Verreth, C.; Hernández-Lucas, I.; Martínez-Romero, E.; Vanderleyden, J. 2003. Identification of a third sulfate activation system in <i>Sinorhizobium</i> sp. Strain BR816: the CysDN sulfate activation complex. <i>Applied and Environmental Microbiology</i> 69: 2006-2014.

ID	41_Vanderleyden_b
Author	Vanderleyden, J. Centre of Microbial and Plant Genetics, Kasteelpark Arenberg 20, B-3001 Heverlee, Belgium Jozef.Vanderleyden@agr.kuleuven.ac.be; +32 16 32 96 79
Parameter	Study of colony morphology
System	Laboratory test with cultivated bacteria
Method	Evaluation of colonies on plate
Method description	<p><i>For the identification of rhizobial strains:</i> Yeast Extract Mannitol (YEM) agar plates with Congo red (200X stock solution with 0.25% Congo red in 0.2N KOH) are used to discriminate rhizobia from contaminants. Rhizobia will not take up much of the Congo red and appear pink while e.g. <i>Escherichia coli</i> contaminants will colour deep red.</p> <p><i>For the evaluation of swarming (flagella-driven movement across an agar surface in the presence of extracellular slime):</i> YEM soft agar plates (0.75%) are dried (16°C) and spot inoculated on the surface with the appropriate <i>Rhizobium</i> wild-type or mutant strain. The plates are incubated for 7 days at 30°C. Under these conditions one can discriminate between strains able to swarm and those that are no longer able to move over this solid surface. In contrast, the latter forms a regular colony at the inoculation point. Detailed observation shows features such as rafts, scalloping or finger-like extrusions, smooth colony edges, glistening film, ... Macroscopic observation of the colony is done with a digital camera (Sony). Light microscopic photographs are taken using a Leica microscope (MZ FLIII) connected to a SPOT RT Slider (ImagePro software).</p>
Do's, don'ts, potential limitations, untested possibilities	The swarming method described above is optimized for the evaluation of <i>Rhizobium etli</i> strains.
References	<p><i>Example of results on evaluation of swarming in R. etli:</i> Daniels, R.; Vanderleyden, J.; Michiels, J. 2004. Quorum sensing and swarming migration in bacteria. FEMS Microbiol. Rev. 28: 261-289.</p> <p><i>Evaluation of swarming in other bacteria:</i> Harshey, R.M. 1994. Bees aren't the only ones: swarming in gram-negative bacteria. Mol. Microbiol. 13: 389-394.</p> <p>Fraser, G.M.; Hughes, C. 1999. Swarming motility. Curr. Opin. Microbiol. 2: 630-635.</p>

ID	41_Vierheilig_a
Author	Horst Vierheilig; Siegrid Steinkellner; Institut für Pflanzenschutz (BOKU), Department für Angewandte Pflanzenwissenschaften und Pflanzenbiotechnologie Peter-Jordan-Str. 82; A-1190 Wien/Austria nonhorst@boku.ac.at; ++43 1 47654-3391
Parameter	Collection of root exudates of plants colonized and non-colonized by arbuscular mycorrhizal fungi
Soil type	Any soil with few organic particles (hard to wash off the roots)
Plant species	Any plant
Method	Root washing with distilled water
Method description	<i>Plants inoculated and non-inoculated with AMF are grown in a substrate which is easy to wash of the root (we use a soil:sand:expanded clay /1:1:1/v:v:v mixture). When roots are colonized, plants are harvested by gently washing the growth substrate from the roots. In order to obtain exudates roots of whole plants are placed in sterile distilled water (we leave them between 20 to 24 h in the water) in the same conditions as the plants were grown before. Roots are covered by a plastic or aluminium foil (dark).</i> Thereafter the root fresh weight (FW) and the degree of mycorrhization is determined. In order to standardize the exudate concentrations from different treatments of plants, a similar ratio "root FW/root exudates solution (w/v) is adjusted (e.g. 1 g FW equivalent to 20 ml of exudate solution). Exudates are passed through millipore filters (0,22 µm) and all tested exudates are adjusted with HCL or KOH to the same pH. Exudates are stored at -20°C until use.
Do's, don'ts, potential limitations, untested possibilities	<ul style="list-style-type: none"> • The technique should be an easy system to obtain root exudates from mycorrhizal and non-mycorrhizal plants. The collection of the exudates is not in sterile conditions, thus other micro-organisms might interfere. The impact of other organisms can be reduced by using at all steps sterile water and by reducing the time exudates are collected from the root. Moreover, to have similar microbial environment in the treatments except for the AMF when growing the control plants can be treated with a filtrate from the mycorrhizal inoculum. • We observed interesting differences of the effect of root exudates of mycorrhizal and non-mycorrhizal plants on other micro-organisms.
References	Piniór, A.; Wyss, U.; Piche, Y; Vierheilig, H. 1999. Plants colonized by AM fungi regulate further root colonization by AM fungi through altered root exudation. <i>Can. J. Bot.</i> 77: 891-897 Vierheilig, H.; Lerat, S.; Piche, Y. 2003. Systemic inhibition of arbuscular mycorrhiza development by root exudates of cucumber plants colonized by <i>Glomus mosseae</i> . <i>Mycorrhiza</i> 13: 167-170

ID	41_Vierheilig_b
Author	Vierheilig, Horst Institut für Pflanzenschutz (BOKU), Department für Angewandte Pflanzenwissenschaften und Pflanzenbiotechnologie Peter-Jordan-Str. 82; A-1190 Wien/Austria nonhorst@boku.ac.at; ++43 1 47654-3391;
Parameter	In vivo observation of arbuscular mycorrhizal structures in intact living roots
Soil type	Any soil with few organic particles (hard to wash of the roots)
Plant species	Plants used so far: Rye-grass (<i>Lolium perenne</i>); tobacco
Method	Laser Scanning Confocal Microscopy (LSCM)
Method description	Laser Scanning Confocal Microscopy allows to visualize fluorescing structure in roots without mechanical sectioning. Collapsed arbuscules autofluoresce and can thus be imaged by LSCM in living roots without any pretreatment. However, no living AM structures can be observed this way. To observe living AM structures, fluorescent markers (e.g. 5 (6)-carboxyfluorecin) are administered to abraded leaves. The marker is transported to the root, where they move into the adjacent pericycle, endodermal, cortical, and epidermal cells. Thus all AM fungal structures such as intraradical hyphae and arbuscules become visible in the intact living root
Do's, don'ts, potential limitations, untested possibilities	<ul style="list-style-type: none"> • Until now this method has been used only with thin roots. It is not known whether similar results can be obtained with thicker roots. • Working with fluorescent markers could allow to obtain images of the dynamic of root colonization by AMF, starting with the penetration of the fungus into the root, the hyphal growth within the root and the formation of vesicles and arbuscules and later on the degradation of arbuscules.
References	Vierheilig, H.; Bockenhoff, A.; Knoblauch, M.; Juge, C.; Van Bel, A.J.E.; Grundler, F.; Piche, Y.; Wyss, U. 1999. In vivo observations of the arbuscular mycorrhizal fungus <i>Glomus mosseae</i> in roots by confocal laser scanning microscopy. <i>Mycol. Res.</i> 103 : 311-314 Vierheilig, H.; Knoblauch, M.; Juergensen, K.; VanBel, A.J.E.; Grundler, F.M.W.; Piche, Y. 2001. Imaging arbuscular mycorrhizal structures in living roots of <i>Nicotiana tabacum</i> by light, epifluorescence, and confocal laser scanning microscopy. <i>Canadian Journal of Botany</i> 79: 231-237.
Links	See Laser Scanning Confocal Microscopy sheet 41_Schweiger_b

ID	41_Vierheilig_c
Author	Vierheilig, Horst Institut für Pflanzenschutz (BOKU); Department für Angewandte Pflanzenwissenschaften und Pflanzenbiotechnologie Peter-Jordan-Str. 82; A-1190 Wien/Austria nonhorst@boku.ac.at; ++43 1 47654-3391
Parameter	Observation of stained arbuscular mycorrhizal structures in roots
Plant species	Any plant
Method	Staining of arbuscular mycorrhizal fungi with ink and vinegar
Method description	<p>Roots are cleared e.g. by KOH (10%). Depending on the age and the thickness roots have to be boiled (90°C) in KOH (e.g. soybean 4 weeks old 4 to 5 min).</p> <p>Roots are rinsed several times with tap water and thereafter boiled another 3 to 5 min with the staining solution. The staining solution consists of normal household vinegar (= usually 5% acetic acid) with 5% ink. To remove excess dye, roots are rinsed around 20 min 2 to 3 times with tap water acidified with a few drops of vinegar.</p> <p>The ink/vinegar staining technique gives excellent staining results of all AMF structures in roots. Moreover, as it uses non-toxic chemical compounds which can be easily purchased at reasonable prices it is not only suitable for research but also for teaching.</p>
Do's, don'ts, potential limitations, untested possibilities	<ul style="list-style-type: none"> • A pre-requisite for good staining results is an adequate clearing of the root. Too long clearing results in a desintegration of the root. Too short clearing results in dark, non-transparent roots, where stained fungal structures are hard to distinguish. • Some inks do not stain the fungus. I mentioned in the first publication that people should always indicate in their publication which ink they used. Unfortunately not all do so. If you use an ink which not has been reported before to stain the fungus, you first have to test its staining quality by comparing it with e.g. trypan blue staining. We obtained best results with a "Shaeffer JetBlack" ink. • The technique can also be used to stain other fungi e.g. <i>Rhizoctonia solani</i>. When observing the stained structures with a Wild M8 Zoom-Stereomicroscope structures were clearest with a dark field illumination. If desired after microscopical observation the roots and the fungus can be completely destained by incubating the roots again in KOH
References	<p>Vierheilig, H.; Coughlan, A.; Wyss, U.; Piché, Y. 1998. Ink and vinegar, a simple staining technique for arbuscular-mycorrhizal fungi. Appl. Environ. Microbiol. 64: 5004-5007.</p> <p>Vierheilig, H.; Piché, Y. 1998. A modified procedure for staining arbuscular mycorrhizal fungi in roots. J. Plant Nutr. Soil Sci. 161: 601-602.</p> <p>Vierheilig, H.; Schweiger, P.; Brundrett, M. 2005. An overview of methods for the detection and observation of arbuscular mycorrhizal fungi in roots. Physiol. Plantarum 125: 393-404.</p> <p><i>A recent publication with nice images of stained structures and a slightly modified ink staining technique:</i></p> <p>Demchenko, K.; Winzer, T.; Stougaard, J.; Parniske, M.; Pawlowski, K. 2004. Distinct roles of Lotus japonicus SYMRK and SYM15 in root colonization and arbuscule formation. New Phytol. 163 (2): 381-392.</p>

ID	41_Wallander_a
Author	Håkan Wallander Department of Microbial Ecology, Ecology building, Lund University, S-223 62 Lund, Sweden Hakan.Wallander@mbioekol.lu.se; ++46 46 2223759
Parameter	Fungal biomass
Soil type	forest soil
Plant species	pine, spruce, birch
System	field soil, microcosm
Method	Ergosterol
Method description	Soil or roots (ball-milled) are extracted with 10% KOH in methanol, refluxed at 70 °C for 30 min. After cooling, 0.5 ml of H ₂ O and 1.5 ml of cyclohexane are added. The samples are mixed in a vortex apparatus and centrifuged. The cyclohexane phase is transferred to a new test tube and evaporated under N ₂ . The samples are then dissolved in methanol and filtered through a 0.5 µm teflon syringe filter (Millex LCR-4, Millipore, Milford, USA). Ergosterol in the filtrate is quantified by HPLC. The chromatographic system used in our lab is equipped with a UV detector and a C ₁₈ reverse-phase column preceded by a C ₁₈ reverse-phase guard column. Extracts are eluted with methanol at a flow rate of 1 ml min ⁻¹ and monitored at 282 nm.
Do's, don'ts, potential limitations, untested possibilities	Separation from contaminating compounds can be difficult in peat or peaty soils. Different fungal species can differ in ergosterol content which can make interpretation difficult. Arbuscular mycorrhizal fungi do not contain ergosterol.
References	Nylund, J.-E.; Wallander, H. 1991. Ergosterol analysis as a means of quantifying mycorrhizal biomass. In: Norris, J.R.; Read, D.J.; Varma, A.K. (eds.) <i>Methods in Microbiology</i> 24. Academic Press, London. Olsson, P.A.; Larsson, L.; Bago, B.; Wallander, H.; van Aarle, I.M. 2003. Ergosterol and fatty acids for biomass estimation of mycorrhizal fungi. <i>New Phytologist</i> 159: 5-7

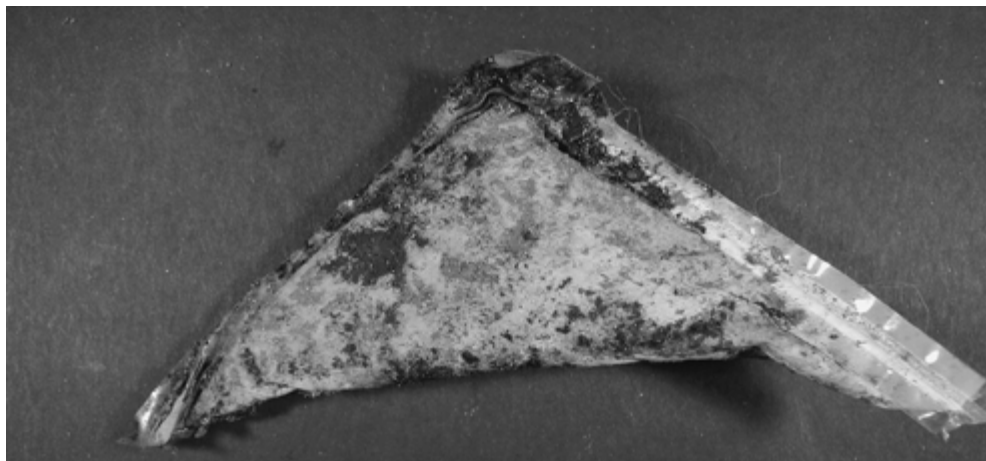
ID	41_Wallander_b
Author	Håkan Wallander Department of Microbial Ecology, Ecology building, Lund University, S-223 62 Lund, Sweden; Hakan.Wallander@mbioekol.lu.se; ++46 46 2223759
Parameter	Production of external ectomycorrhizal mycelia in the field
Soil type	acid forest soil, sand-dune soil
Plant species	pine, spruce, grass
System	field soil
Method	In-growth mesh bags
Method description	Mesh bags (mesh size 25-50µm) are filled with acid washed quartz sand (approximately 50-100g). These are buried in the soil for various periods of time. At harvest the amount of fungal biomass is estimated. This can be done by ergosterol analysis, PLFA 18:2w6,9 analysis or extraction of mycelia from the sand followed by the loss of ignition as an estimate of biomass. As controls of mycelial production by saprotrophic, non-mycorrhizal fungi, mesh bags can also be placed inside trenched plots. These are created by PVC tubes that have been forced down into the soil to cut off volumes of soil from external sources of carbon (= tree roots).
Do's, don'ts, potential limitations, untested possibilities	The method probably works best in mineral soils since sand is more similar to mineral than to organic soil. It might be possible to use other material than sand to better mimic organic soils. We have tried with vermiculite, but it dried out. It might be possible to add some other inert water absorbing material for an improved water holding capacity.
References	Nylund, J.-E.; Wallander, H. 1991. Ergosterol analysis as a means of quantifying mycorrhizal biomass. In: Norris, J.R.; Read, D.J.; Varma, A.K. (eds.) <i>Methods in Microbiology</i> 24. Academic Press, London. Olsson, P.A. 1999. Signature fatty acids provide tools for determining of the distribution and interactions of mycorrhizal fungi in soil. <i>FEMS Microbiology Ecology</i> 29: 303-310. Wallander, H.; Nilsson, L.-O.; Hagerberg, D.; Bååth, E. 2001. Estimation of the biomass and seasonal growth of external mycelium of ectomycorrhizal fungi in the field. <i>New Phytologist</i> 151: 753-760 Olsson, P.A.; Wilhelmsson, P. 2000. The growth of external AM fungal mycelium in sand dunes and in experimental systems. <i>Plant and Soil</i> 226: 161-169
Additional information	 <p>Fig. 1. mesh bag retrieved from soil</p>

ID	42_Friedel_a
Author	Friedel, Juergen Division of Organic Farming, Dpt. of Sustainable Agricultural Systems, University of Applied Life Sciences and Renewable Resources Vienna, Gregor Mendel Str. 33, A-1180 Vienna juergen.friedel@boku.ac.at; ++43 1 47654 3757
Parameter	Arginine ammonification
Soil type	arable soils
Plant species	crops
Method	Deamination of arginine incubated with soil
Method description	Soil samples (2.0 g) are incubated with arginine solution (0.5 ml) at 30°C for 3 h. Ammonium is determined in 2M KCl extracts on incubated samples and frozen control samples. For method of ammonium determination see 22_Friedel_a .
Do's, don'ts	Soil samples should stored moist at 4°C prior to analysis.
References	<i>Arginine ammonification method:</i> Alef, K.; Kleiner, D. 1986. Arginine ammonification, a simple method to estimate microbial activity potentials in soils. Soil Biol. Biochem. 18: 233-235.

ID	42_Friedel_b
Author	Friedel, Juergen Division of Organic Farming, Dpt. of Sustainable Agricultural Systems, University of Applied Life Sciences and Renewable Resources Vienna, Gregor Mendel Str. 33, A-1180 Vienna juergen.friedel@boku.ac.at; ++43 1 47654 3757
Parameter	Soil microbial biomass C and N
Soil type	arable soils
Plant species	crops
System	rhizobox
Method	Chloroform fumigation extraction
Method description	Microbial biomass C and N is estimated by fumigation extraction method in rhizobox layers of 0.5mm. Required amount of soil: 1.2 g for fumigated sample, 1.2 g for unfumigated control. Soil-to-0.5 M K ₂ SO ₄ solution ratio = 1 : 15. Determination of C and N in extracts: see 22_Friedel_b .
Do's, don'ts, potential limitations, untested possibilities	<ul style="list-style-type: none"> • Extracts can be frozen prior to analysis. Precipitation of CaSO₄ due to freezing does not interfere with C and N analysis. • The proportionality factor K_{EC} for converting the flush in K₂SO₄ extractable C into biomass C depends on the methodology for determining C in the solution (Wu et al., 1990). • Analysis of biomass N can also be done by measuring ninhydrin-reactive N.
References	<p><i>Description of standard procedure:</i> Brookes, P.C.; Landman, A.; Pruden, G.; Jenkinson, D.S. 1985. Chloroform fumigation and the release of soil nitrogen: A rapid direct extraction method to measure microbial biomass nitrogen in soil. <i>Soil Biol. Biochem.</i> 17: 837-842.</p> <p>Vance, E.D.; Brookes, P.C.; Jenkinson, D.S. 1987. An extraction method for measuring soil microbial biomass C. <i>Soil Biol. Biochem.</i> 19: 703-707</p> <p><i>Methodology for determining K₂SO₄ extractable C:</i> Wu, J.; Joergensen, R.G.; Pommerening, B.; Chaussod, R.; Brookes, P.C. 1990. Measurement of soil microbial biomass C by fumigation-extraction - an automated procedure. <i>Soil Biol. Biochem.</i> 22: 1167-1169.</p> <p><i>Biomass N measurement by analysis of ninhydrin-reactive N:</i> Amato, M.; Ladd, J.N. 1988. Assay for microbial biomass based on ninhydrin-reactive nitrogen in extracts of fumigated soils. <i>Soil Biol. Biochem.</i> 20: 107-114.</p> <p><i>Micro-scale fumigation-extraction method using KCl solution and determining ninhydrin-reactive N:</i> Jensen, L. S.; Sorensen, J. 1994. Microscale fumigation-extraction and substrate-induced respiration methods of measuring microbial biomass in barley rhizosphere. <i>Plant and Soil</i> 162: 151-161.</p>

ID	42_Friedel_c
Author	Friedel, Juergen Division of Organic Farming, Dpt. of Sustainable Agricultural Systems, University of Applied Life Sciences and Renewable Resources Vienna, Gregor Mendel Str. 33, A-1180 Vienna juergen.friedel@boku.ac.at; ++43 1 47654 3757
Parameter	Nitrogen mineralization
Soil type	arable soils
Plant species	crops
Method	Nitrogen mineralisation by anaerobic incubation
Method description	Water saturated soil samples (5.0 g) are incubated in reagent vials with 15 ml dest. water at 40°C for 7 d. Ammonium is determined in 2M KCl extracts on incubated samples and frozen control samples. For method of ammonium determination see 22_Friedel_a .
Do's, don'ts, potential limitations, untested possibilities	<ul style="list-style-type: none"> • Soil samples should be stored moist at 4°C prior to analysis. Drying and re-moistening can result in a lag-phase or in a flush of N release. • When reducing amount of soil, keep soil : solution ratio constant and reduce vial size. • N mineralisation rates in anaerobic incubation often exceed N mineralisation rates in aerobic incubation due to a decrease in N immobilisation.
References	<i>Anaerobic incubation method:</i> Keeney, D.R.; Bremner, J.M. 1966. Comparison and evaluation of laboratory methods of obtaining an index of soil nitrogen availability. <i>Agronomy Journal</i> 58: 498-503. Beck, T. 1983. Die N-Mineralisierung von Böden im Laborbrutversuch. <i>Zeitschrift für Pflanzenern. und Bodenkunde</i> 146: 243-252.

ID	42_Gil_Sotres_a
Author	Gil-Sotres, F. ¹⁾ ; Leirós, M.C. ¹⁾ ; Trasar-Cepeda, C. ²⁾ ¹⁾ Dep. Edafología, Fac. Farmacia, USC, E-15782 Santiago de Compostela, Spain; ++34 981563100 ext. 14984; edgils@usc.es; edleiros@usc.es ²⁾ IIAG-CSIC, Apartado 122, E-15780 Santiago de Compostela, Spain; ++34 981590958; ctrasar@iiag.cesga.es
Parameter	Arginine ammonification rate
Soil type	All soil types
System	Laboratory
Method	Static soil incubation
Method description	Sieved moist soil is incubated with and without an arginine solution for 3 h at 30 °C. The released ammonium is extracted with a KCl 2M solution and determined colorimetrically by the phenol sodium nitroprusside method. The arginine ammonification rate is calculated as the difference between the ammonium content in arginine-treated and untreated soil samples
References	Alef, K.; Kleiner, D. 1986. Arginine ammonification, a simple method to estimate microbial activity potentials in soils. <i>Soil Biology and Biochemistry</i> 18: 233-235. Dorich, R.A.; Nelson, D.W. 1983. Direct colorimetric measurement of ammonium in KCl extracts of soils. <i>Soil Science Society of America Journal</i> 47: 833-836.

ID	42_Gil_Sotres_b
Author	Gil-Sotres, F. ¹⁾ ; Leirós, M.C. ¹⁾ ; Trasar-Cepeda, C. ²⁾ ¹⁾ Dep. Edafología, Fac. Farmacia, USC, E-15782 Santiago de Compostela, Spain; ++34 981563100 ext. 14984; edgils@usc.es; edleiros@usc.es ²⁾ IIAG-CSIC, Apartado 122, E-15780 Santiago de Compostela, Spain; ++34 981590958; ctrasar@iiag.cesga.es
Parameter	ATP content
Soil type	All soil types
System	Laboratory
Method	Luciferine-luciferase reaction
Method description	Sieved moist soil is extracted with an appropriate ATP-extractant solution and the ATP in the extract is quantified by the luciferine-luciferase method using a luminometer to measure the evolved light.
Do's, don'ts, potential limitations, untested possibilities	<ul style="list-style-type: none"> • Extraction conditions (extractant, temperature, time of extraction, soil:extractant ratio, etc.) are different depending on soil pH and soil organic matter content. • Diverse protocols for the quantification of the ATP in the extracts have been also published.
References	Alef, K.; Nannipieri, P. 1995. Methods in Applied Soil Microbiology and Biochemistry. Academic Press, London, 512 pp.

ID	42_Gil_Sotres_c
Author	Gil-Sotres, F. ¹⁾ ; Leirós, M.C. ¹⁾ ; Trasar-Cepeda, C. ²⁾ ¹⁾ Dep. Edafología, Fac. Farmacia, USC, E-15782 Santiago de Compostela, Spain; ++34 981563100 ext. 14984; edgils@usc.es; edleiros@usc.es ²⁾ IIAG-CSIC, Apartado 122, E-15780 Santiago de Compostela, Spain; ++34 981590958; ctrasar@iiag.cesga.es
Parameter	Microbial biomass C and N
Soil type	All soil types
System	Laboratory
Method	Fumigation-extraction
Method description	Unfumigated and fumigated (fumigation with chloroform during 24 h at 25 °C) soil samples are extracted with a solution of K ₂ SO ₄ 0.5M. The carbon and nitrogen of the biomass are calculated as the difference between the C and N contents of the extracts of fumigated and unfumigated samples, applying a correction factor. The carbon content of the soil extracts is usually estimated by dichromate oxidation or persulphate oxidation. For the estimation of biomass-N either total N, total inorganic N or N-ninhydrine reactive contents can be used.
Do's, don'ts, potential limitations, untested possibilities	<ul style="list-style-type: none"> • There is not a general consensus about the factors used for the estimation of both biomass C and N. • The presence of roots causes the overestimation of the microbial biomass. • In soils with a high moisture content the fumigation is not totally effective.
References	<p>Vance, E.D.; Brookes, P.C.; Jenkinson, D.S. 1987. An extraction method for measuring soil microbial biomass-C. <i>Soil Biology and Biochemistry</i> 19: 703-707.</p> <p>Wu, J.; Joergensen, R.G.; Pommering, B.; Chaussod, R.; Brookes, P.C. 1990. Measurement of soil microbial biomass by fumigation extraction – an automated procedure. <i>Soil Biology and Biochemistry</i> 22: 1167-1169.</p> <p>Joergensen, R.G.; Brookes, P.C. 1990. Ninhydrin reactive nitrogen measurements of microbial biomass in 0.5 M K₂SO₄ soil extracts. <i>Soil Biology and Biochemistry</i> 22: 1023-1027.</p> <p>Joergensen, R.G.; Meyer, B. 1990. Nutrient changes in decomposing beech leaf litter assessed using a solution flux approach. <i>Journal of Soil Science</i> 41: 279-293.</p>
Additional information	Literature regarding soil microbial biomass C and N is very abundant.

ID	42_Gil_Sotres_d
Author	Gil-Sotres, F. ¹⁾ ; Leirós, M.C. ¹⁾ ; Trasar-Cepeda, C. ²⁾ ¹⁾ Dep. Edafología, Fac. Farmacia, USC, E-15782 Santiago de Compostela, Spain; ++34 981563100 ext. 14984; edgils@usc.es; edleiros@usc.es ²⁾ IIAG-CSIC, Apartado 122, E-15780 Santiago de Compostela, Spain; ++34 981590958; ctrasar@iiag.cesga.es
Parameter	N-mineralisation potential
Soil type	All soil types
System	Laboratory
Method	Static incubation
Method description	Sieved soil at field capacity moisture content is incubated at 25 °C for 10 days in closed containers. The nitrogen mineralised (total inorganic N, N-NH ₄ ⁺ or N-NO ₃ ⁻) is estimated from the difference between the inorganic N content before and after incubation. Inorganic N is usually extracted with KCl 2M. The measurement of the forms of inorganic N in these extracts can be carried out by different methods, but the most common is the Kjeldahl distillation.
Do's, don'ts, potential limitations, untested possibilities	To avoid anaerobic conditions during the incubation it is necessary to open the container every 2 or 3 days.
References	Bremner 1965. In: Black et al. (eds.) Methods of Soil Analysis, SSSA, Madison, USA, pp. 1179-1237.
Additional information	Different authors use variable incubation conditions: length, temperature and soil moisture level.

ID	42_Gil_Sotres_e
Author	Gil-Sotres, F. ¹⁾ ; Leirós, M.C. ¹⁾ ; Trasar-Cepeda, C. ²⁾ ¹⁾ Dep. Edafología, Fac. Farmacia, USC, E-15782 Santiago de Compostela, Spain; ++34 981563100 ext. 14984; edgils@usc.es; edleiros@usc.es ²⁾ IIAG-CSIC, Apartado 122, E-15780 Santiago de Compostela, Spain; ++34 981590958; ctrasar@iiag.cesga.es
Parameter	Soil respiration
Soil type	All soil types
System	Laboratory
Method	Static incubations
Method description	Sieved soil at field capacity moisture content is incubated in closed containers for 10 days at 25 °C in the presence of an alkali solution to trap the CO ₂ evolved. The determination of the CO ₂ is carried out by titration with a strong acid solution.
Do's, don'ts, potential limitations	<ul style="list-style-type: none"> • The presence of fine roots increases soil respiration. • The presence of carbonates in the soil causes an abiotic release of CO₂.
References	Isermeyer 1952. Zeitschrift für Pflanzenernährung und Bodenkunde 56: 26-38.
Additional information	There are different methods available for both the incubation protocol and the determination of evolved CO ₂ .

ID	42_Neumann
Author	Neumann, Günter Institute of Plant Nutrition (330), Hohenheim University, D-70593 Stuttgart, Germany gd.neumann@t-online.de; ++49 711 459 4273
Parameter	Quantitative determination of acid phosphatase activity in the rhizosphere and on the root surface
Soil type	All soils
Plant species	All species
System	Hydroponics, Soil culture
Method	Spectrophotometric assay
Method description	<p><i>Principle:</i> The artificial substrate p-Nitrophenylphosphate (NPP) is hydrolyzed by acid phosphatase. Under alkaline conditions, the dephosphorylated reaction product p-nitrophenol (PNP) turns yellow and exhibits absorption at 405 nm, which can be quantified photometrically using an alkaline solution of PNP as a standard.</p> <p><i>Collection of rhizosphere/bulk soil:</i> Plants grown in pots or rhizoboxes. Carefully remove plants from the soil. Remove soil, loosely adhering to the root surface by shaking the root system (outer rhizosphere soil). Dip the root system into water (appropriate and defined volume to completely cover the root system); 1 min gently shaking to remove inner rhizosphere soil = rhizosphere soil suspension. Also suspend a comparable aliquot of bulk soil in a defined volume of water.</p> <p><i>Enzyme test:</i> <i>Sample:</i> Transfer 0.5 mL aliquots of soil suspensions into 2 mL Eppendorf reaction vials (use micropipette with cut tips). Add 0.4 mL Na-Ac buffer and 0.1 mL Substrate (NPP) solution. Incubate 30-60 min at 25-30°C (mix occasionally). Terminate reaction by addition of 0.5 mL 0.5 M NaOH.</p> <p><i>Control:</i> (correction for background colouration by humic acids etc.): 0.5 mL soil suspension + 0.4 mL buffer. Incubate 30-60 min at 30°C, add 0.5 mL 0.5 M NaOH + 0.1 mL NPP substrate. Remove soil by centrifugation. Measure absorption of all supernatants at 405 nm. Subtract absorption values of control samples. Drying of the soil pellet at 90°C. Determination of soil sample dry weight as a reference base.</p>
Do's, don'ts, potential limitations, untested possibilities	<ul style="list-style-type: none"> • Using 0.1 M Trizma buffer (pH 7.8) instead of Na-acetate buffer (pH 5.2), allows the determination of alkaline phosphatase activity in the same soil samples. • Test not applicable in very heavy soils where removal of rhizosphere soil by shaking is not possible.
References	Alvey, S.; Bagayoko, M.; Neumann, G.; Buerkert, A. 2000. Cereal/legume rotation effects in two West African soils under controlled conditions. Plant Soil 231: 45-54.

Additional information:

Acid phosphatase activity at the root surface

Harvest root segments (1.5 - 2 cm) and transfer to 2 mL Eppendorf reaction vials; wash 2 times with distilled water for 5 min to remove contents of wounded cells; add 0.5 mL water + 0.4 mL Na-acetate buffer + 0.1 mL NPP substrate. After a reaction time of 5 -10 min at 25-30°C remove 0.8 mL of the reaction medium and mix with 0.4 mL of 0.5M NaOH to terminate the reaction. Measure absorption at 405 nm. Determination of root sample dry weight as a reference base.

Reagents:

- 200 mM Na-acetate buffer pH 5.2
- 0.5 M NaOH
- Substrate: 150 mM p-nitrophenyl phosphate (NPP) in acetate buffer
- p-Nitrophenol standard 20 µg/mL

Buffers and PNP standard solution are stable for several weeks at 8°C. Daily preparation of NPP substrate solution.

Calibration curve with p-nitrophenol (PNP):

PNP stock [20 µg/mL]: PNP [0-20 µg/mL]

PNP [µg/mL]	Vol. PNP stock [µL]	Vol. H ₂ O [µL]	Vol. 0.5M NaOH [µL]
0	0	500	250
2	50	450	250
4	100	400	250
8	200	300	250
12	300	200	250
16	400	100	250
20	500	0	250

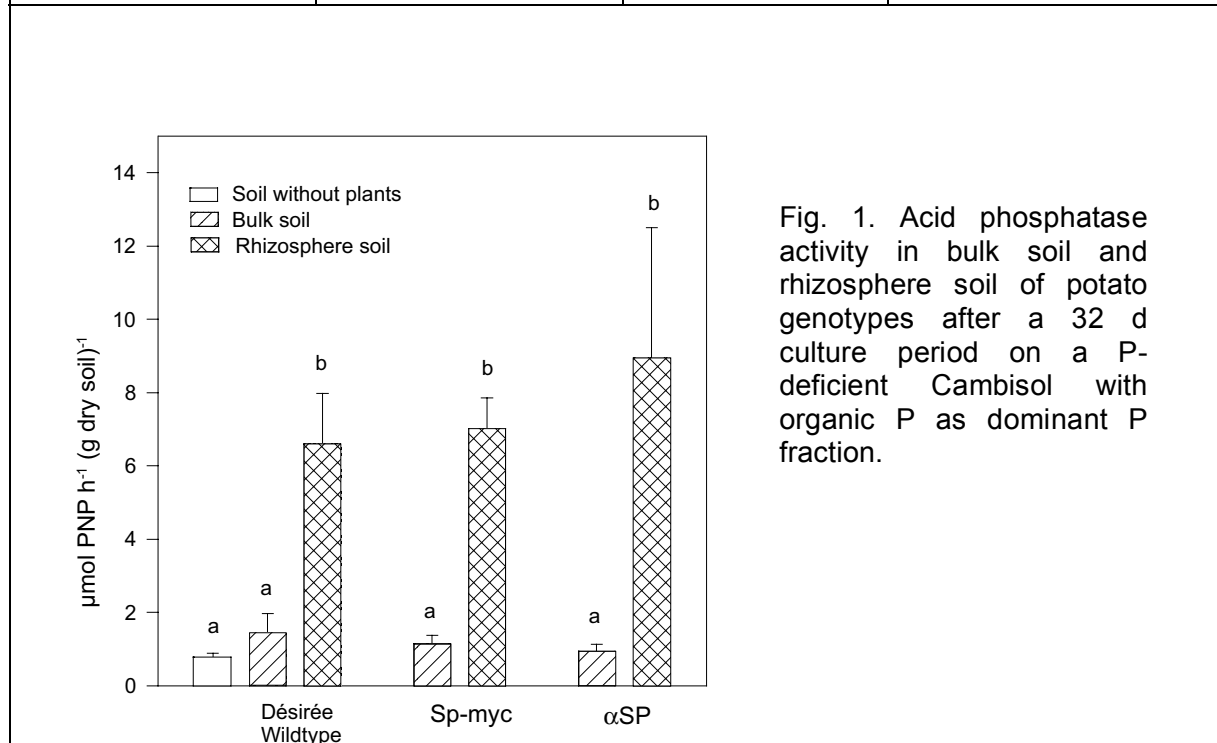

Fig. 1. Acid phosphatase activity in bulk soil and rhizosphere soil of potato genotypes after a 32 d culture period on a P-deficient Cambisol with organic P as dominant P fraction.

ID	42_Pritsch
Author	Pritsch, Karin Technische Universitaet Muenchen (TUM), Chair of Soil Ecology at GSF, Ingolstaedter Landstr. 1, D-85764 Neuherberg, Germany pritsch@gsf.de; ++49 89 31 87 34 87
Parameter	Potential enzymatic activities
Plant species	any species
System	(mycorrhizal) root tips
Method	Fluorescence microplate assay for detection of enzyme activities on single (mycorrhizal) roots
Method description	<p><i>Sample preparation:</i> Mycorrhizal roots are cleaned and sorted at the day of assay and kept moist until use. Tips of 2-4 mm length are used for assays.</p> <p><i>Fluorescence substrates:</i> Substrate solutions for the enzyme assays are based on methylumbelliferone or aminomethylcoumarin labelled substrate analogues. Substrate solutions can be prepared in different concentrations and used as described by Pritsch et al. (2004, 2005).</p> <p><i>Microsieves:</i> During the assay procedures, single excised (mycorrhizal) root tips are kept and transferred in (self-made) microsieve strips which reduce potential damage to the roots. Individual roots can thus be subsequently used for measurements at different concentrations, pHs or with different substrates (Pritsch et al., 2004).</p> <p><i>Analysis:</i> Fluorescence measurements are performed in black microtiter plates with a fluorescence spectrometer equipped with a microplate reader. For calculations of substrate turnover, calibration curves are included.</p>
Do's, don'ts, potential limitations, untested possibilities	<p><i>Quantification of enzyme activities:</i> For calculations on activities, roots can be weighed individually on very fine scales (20-200 µg dw), but it is much more convenient to scan roots after the enzyme tests and to determine their projection area by using for example WinRhizo (http://www.regentinstruments.com/). Projection area and dry weight are linearly correlated (Buée et al., 2004).</p> <p><i>Assay conditions:</i> Optimal substrate concentrations have to be tested for every application. Too high concentration can cause an inhibition of enzymatic activity, at too low concentrations, enzyme reactions may be suboptimal. pH-optima are different among enzymes and pH optima of isoforms of one enzyme can also differ. This has also to be tested for every enzyme and also for different EM types.</p> <p><i>Some special remarks on the fluorescent chemicals:</i> <i>usefulness:</i> from the number of substrates available the following appeared to be working and useful. MU-phosphate, MU-N-acetylglucosaminide, MU-β-glucoside, MU-cellobioside, MU-glucuronide, MU-xyloside, Leu-AMC. Also tested but not further used were MU-acetate (unstable), Tyr-AMC, Arg-AMC</p>

	<p>(too expensive).</p> <p><i>Stability:</i> methylumbelliferone standards have to be prepared freshly, because the dissolved substance is not stable. Solutions may be kept at 4 °C for up to 3 days without a decrease of fluorescence.</p> <p><i>Fluorescence properties:</i> methylumbelliferone has optimal fluorescence properties at alkaline pH. Therefore, in the original protocol, an alkalization step is included before the measurements. Due to the high sensitivity of the fluorescence method, this may not be necessary in all cases as described for a soil assay (Marx et al. 2000). This possibility has not been tested yet.</p> <p><i>Equipment:</i> A fluorescence spectrometer with microplate reader may not be present in every lab. However, microplate fluorimeters are often used in molecular biological labs using fluorescence DNA or RNA detection and then only the filter sets may have to be changed.</p> <p><i>Controlled conditions:</i> Incubation has to take place on a shaker at controlled and constant temperature to ensure reproducible conditions.</p>
References	<p><i>First description of the fluorescence microplate method for mycorrhizae using sieve strips:</i> Pritsch, K.; Raidl, S.; Marksteiner, E.; Blaschke, H.; Agerer, R.; Schloter, M.; Hartmann, A. 2004. Journal of Microbiological Methods 58: 233-241.</p> <p><i>corrected substrate concentrations in</i> do. 2005. Journal of Microbiological Methods 61: 141</p> <p><i>First description of the method using different substrates in subsequent tests:</i> Courty, P.E.; Pritsch, K.; Schloter, M.; Hartmann, A.; Garbaye, J. 2005. New Phytol. 167: 109-119.</p> <p><i>Use of WinRhizo for determination of the surface area:</i> Buée, M.; Vairelles, D.; Garbaye, J. 2004. Mycorrhiza 15: 235-245</p> <p><i>Description of a microplate assay with soil solutions and without alkalization:</i> Marx, M.C.; Wood, M.; Jarvis, S.C. 2001. Soil Biology and Biochemistry 33: 1633-1640.</p>
Links	a protocol for the making of minisieves can be obtained from pritsch@gsf.de

ID	42_Trasar_Cepeda_a
Author	Trasar-Cepeda, C. ¹⁾ ; Gil-Sotres, F. ²⁾ ; Leirós, M.C. ²⁾ ¹⁾ IIAG-CSIC, Apartado 122, E-15780 Santiago de Compostela, Spain. ++34 981590958; ctrasar@iiag.cesga.es ²⁾ Dep. Edafología, Fac. Farmacia, USC, E-15782 Santiago de Compostela, Spain; ++34 981563100 ext. 14984; edgils@usc.es; edleiros@usc.es
Parameter	β-glucosidase activity
Soil type	All soil types
System	Laboratory
Method	Hydrolysis of <i>p</i>-nitrophenyl-β-D-glucopyranoside
Method description	Sieved moist soil is incubated with a <i>p</i> -nitrophenyl-β-D-glucopyranoside solution at pH 6.0 (Modified Universal Buffer) and 37°C for 1 h. After the addition of 0.5 M CaCl ₂ to prevent the dispersion of clay and the extraction of soil organic matter, the released <i>p</i> -nitrophenol is extracted with 0.1M THAM solution at pH 12.0 and measured spectrophotometrically at 400 nm. The <i>p</i> -nitrophenol content of the extracts is calculated by reference to a calibration graph obtained with standards containing different quantities of <i>p</i> -nitrophenol.
Do's, don'ts, potential limitations, untested possibilities	<ul style="list-style-type: none"> • Both the pH of the soil-buffer-substrate mixture and the optimum pH for the activity should be checked for different soils. • In soils with a high organic matter content, the CaCl₂ concentration of the solution used to precipitate the dissolved organic matter should be increased. • In soils with a high level of organic matter or receiving high inputs of organic fertilizers, it is necessary to check the <i>p</i>-nitrophenol adsorption by the soil in order to correct the obtained results if it is the case.
References	<p><i>Description of the method:</i> Eivazi, F.; Tabatabai, M.A. 1988. Glucosidases and galactosidases in soils. <i>Soil Biology and Biochemistry</i> 20: 601-606.</p> <p><i>The use of a CaCl₂ solution of higher concentration in soils with high organic matter content is indicated in:</i> García Izquierdo, C.; Gil Sotres, F.; Hernández Fernández, T.; Trasar Cepeda, C. 2003. Técnicas de análisis de parámetros bioquímicos en suelos. Medida de actividades enzimáticas y biomasa microbiana. Ediciones Mundi-Prensa, Madrid, 371 pp. (in Spanish).</p> <p><i>The problems associated with the adsorption of p-nitrophenol by soils are indicated in:</i> Vuorinen, A.H. 1993. Requirement of <i>p</i>-nitrophenol standard for each soil. <i>Soil Biology and Biochemistry</i> 25: 295-296.</p>
Additional information	In the Eivazi and Tabatabai's method, toluene is used to avoid the growth of microorganisms during the incubation. However, the use of toluene can cause diverse problems, so it is not always recommended. See, among others: Kaplan, D.L.; Hartenstein, R. 1979. Problems with toluene and the determination of extracellular enzyme activity in soils. <i>Soil Biology and Biochemistry</i> 11: 335-338. Skujins, J.J. 1967. Enzymes in Soil. In: McLaren, A.D.; Peterson, G.H. (eds.) <i>Soil Biochemistry</i> , vol. 1. Marcel Dekker, New York, pp. 371-414.

ID	42_Trasar_Cepeda_b
Author	Trasar-Cepeda, C. ¹⁾ ; Gil-Sotres, F. ²⁾ ; Leirós, M.C. ²⁾ ¹⁾ IIAG-CSIC, Apartado 122, E-15780 Santiago de Compostela, Spain. ++34 981590958; ctrasar@iiag.cesga.es ²⁾ Dep. Edafología, Fac. Farmacia, USC, E-15782 Santiago de Compostela, Spain; ++34 981563100 ext. 14984; edgils@usc.es; edleiros@usc.es
Parameter	Arylsulphatase activity
Soil type	All soil types
System	Laboratory
Method	Hydrolysis of <i>p</i>-nitrophenyl sulphate
Method description	Sieved moist soil is incubated with a <i>p</i> -nitrophenyl sulphate solution at pH 5.8 (acetate buffer 0.5M) and 37°C for 1 h. After the addition of 0.5 M CaCl ₂ to prevent the dispersion of clay and the extraction of soil organic matter, the released <i>p</i> -nitrophenol is extracted with 0.5M NaOH solution and measured spectrophotometrically at 400 nm. The <i>p</i> -nitrophenol content of the extracts is calculated by reference to a calibration graph obtained with standards containing different quantities of <i>p</i> -nitrophenol.
Do's, don'ts, potential limitations, untested possibilities	<ul style="list-style-type: none"> In soils with a high organic matter content, the CaCl₂ concentration of the solution used to precipitate the dissolved organic matter should be increased. This also implies the reduction of the concentration of NaOH to avoid the formation of precipitates. In soils with a high level of organic matter or receiving high inputs of organic fertilizers, it is necessary to check the <i>p</i>-nitrophenol adsorption by the soil in order to correct the obtained results if it is the case.
References	<p><i>Description of the analytical procedure:</i> Tabatabai, M.A.; Bremner, J.M. 1970. Arylsulfatase activity of soils. Soil Science Society of America Proceedings 34: 225-229.</p> <p><i>The use of a CaCl₂ solution of higher concentration in soils with high organic matter content (and lower concentration of NaOH) is indicated in:</i> García Izquierdo, C.; Gil Sotres, F.; Hernández Fernández, T.; Trasar Cepeda, C. 2003. Técnicas de análisis de parámetros bioquímicos en suelos. Medida de actividades enzimáticas y biomasa microbiana. Ediciones Mundi-Prensa, Madrid, 371 pp. (in Spanish).</p> <p><i>The problems associated with the adsorption of p-nitrophenol by soils are indicated in:</i> Vuorinen, A.H. 1993. Requirement of p-nitrophenol standard for each soil. Soil Biology and Biochemistry 25: 295-296.</p>
Additional information	In the Tabatabai and Bremner's method, toluene is used to avoid the growth of microorganisms during the incubation. However, the use of toluene can cause diverse problems, so it is not always recommended. See, among others: Kaplan, D.L.; Hartenstein, R. 1979. Problems with toluene and the determination of extracellular enzyme activity in soils. Soil Biology and Biochemistry 11: 335-338. Skujins, J.J. 1967. Enzymes in Soil. In: McLaren, A.D.; Peterson, G.H. (eds.) Soil Biochemistry, vol. 1. Marcel Dekker, New York, pp. 371-414.

ID	42_Trasar_Cepeda_c
Author	Trasar-Cepeda, C. ¹⁾ ; Gil-Sotres, F. ²⁾ ; Leirós, M.C. ²⁾ ¹⁾ IIAG-CSIC, Apartado 122, E-15780 Santiago de Compostela, Spain. ++34 981590958; ctrasar@iiag.cesga.es ²⁾ Dep. Edafología, Fac. Farmacia, USC, E-15782 Santiago de Compostela, Spain; ++34 981563100 ext. 14984; edgils@usc.es; edleiros@usc.es
Parameter	BAA-protease activity
Soil type	All soil types
System	Laboratory
Method	Hydrolysis of N-benzoyl L-arginine amide (BAA)
Method description	Sieved moist soil is incubated with a N-benzoyl L-arginine amide (BAA) solution at 37°C and pH 7.1 (phosphate buffer 0.2 M) for 1.5 h. After the addition of 2M KCl, the released ammonium is measured with an ammonium electrode.
Do's, don'ts, potential limitations, untested possibilities	Both the pH of the soil-buffer-substrate mixture and the optimum pH for the activity should be checked for different soils.
References	<i>Use of dipeptide derivatives to measure proteolytic activity of soils:</i> Ladd, J.N.; Butler, J.H.A. 1972. Short-term assays of soil proteolytic enzyme activities using proteins and dipeptide derivatives as substrates. <i>Soil Biology and Biochemistry</i> 4: 19-30. <i>Description of the analytical procedure:</i> Nannipieri, P.; Ceccanti, B.; Cervelli, S.; Matarese, E. 1980. Extraction of phosphatase, urease, proteases, organic carbon and nitrogen from soil. <i>Soil Science Society of America Journal</i> 44: 1011-1016.
Additional information	The released ammonium can be determined by different methods: distillation by Kjeldhal procedure, spectrophotometrically by the phenol sodium nitroprusside reaction, etc.

ID	42_Trasar_Cepeda_d
Author	Trasar-Cepeda, C. ¹⁾ ; Gil-Sotres, F. ²⁾ ; Leirós, M.C. ²⁾ ¹⁾ IIAG-CSIC, Apartado 122, E-15780 Santiago de Compostela, Spain. ++34 981590958; ctrasar@iiag.cesga.es ²⁾ Dep. Edafología, Fac. Farmacia, USC, E-15782 Santiago de Compostela, Spain; ++34 981563100 ext. 14984; edgils@usc.es; edleiros@usc.es
Parameter	Casein-protease activity
Soil type	All soil types
System	Laboratory
Method	Hydrolysis of casein
Method description	Sieved moist soil is incubated with a casein solution for 2 h at 50°C and pH 8.1 (Tris-HCl buffer 0.05 M). After the addition of 17.5% trichloroacetic acid to stop the reaction and to precipitate the excess of casein, the mixture is centrifugated, and the released aminoacids are determined in the supernatant by the Folin colorimetric method. The casein hydrolysis is determined by relating absorbances at 578 nm with those of a calibration graph constructed with various concentrations of tyrosine standard.
Do's, don'ts, potential limitations, untested possibilities	Some authors (Bonmati et al., 1991) suggested that a better estimation of casein-protease activity is obtained by measuring the casein hydrolysed at various different times of incubation instead of using a single incubation time.
References	<i>Description of the method to measure proteolytic activity of soils using casein:</i> Ladd, J.N.; Butler, J.H.A. 1972. Short-term assays of soil proteolytic enzyme activities using proteins and dipeptide derivatives as substrates. <i>Soil Biology and Biochemistry</i> 4: 19-30. <i>Modification of the analytical procedure:</i> Nannipieri, P.; Pedrazzini, F.; Arcara, P.G.; Piovaneli C. 1979. Changes in amino acids, enzyme activities, and biomasses during soil microbial growth. <i>Soil Science</i> 127: 26-34. Bonmati, M.; Ceccanti, B.; Nannipieri, P. 1991. Spatial variability of phosphatase, urease, protease, organic carbon and total nitrogen in soil. <i>Soil Biology and Biochemistry</i> 23: 391-396.

ID	42_Trasar_Cepeda_e
Author	Trasar-Cepeda, C. ¹⁾ ; Gil-Sotres, F. ²⁾ ; Leirós, M.C. ²⁾ ¹⁾ IIAG-CSIC, Apartado 122, E-15780 Santiago de Compostela, Spain. ++34 981590958; ctrasar@iiag.cesga.es ²⁾ Dep. Edafología, Fac. Farmacia, USC, E-15782 Santiago de Compostela, Spain; ++34 981563100 ext. 14984; edgils@usc.es; edleiros@usc.es
Parameter	Catalase activity
Soil type	All soil types
System	Laboratory
Method	Decomposition of hydrogen peroxide
Method description	Sieved moist soil is incubated with a solution of H ₂ O ₂ for 10 min at 20°C. The remaining H ₂ O ₂ is determined colorimetrically after an enzymatic reaction involving the decomposition of H ₂ O ₂ by a peroxidase and the formation of a pink dye.
References	<i>Incubation procedure:</i> Johnson, J.L.; Temple, K.L. 1964. Some variables affecting the measurement of 'catalase activity' in soil. Soil Science Society of America Proceedings 28: 207-209. <i>Colorimetric method to measure the residual H₂O₂:</i> Trasar-Cepeda, C.; Camiña, F.; Leirós, M.C.; Gil-Sotres, F. 1999. An improved method to measure catalase activity in soils. Soil Biology and Biochemistry 31: 483-485
Additional information	The residual H ₂ O ₂ can be determined by different methods, being titration with potassium permanganate one of the most widely used.

ID	42_Trasar_Cepeda_f
Author	Trasar-Cepeda, C. ¹⁾ ; Gil-Sotres, F. ²⁾ ; Leirós, M.C. ²⁾ ¹⁾ IIAG-CSIC, Apartado 122, E-15780 Santiago de Compostela, Spain. ++34 981590958; ctrasar@iiag.cesga.es ²⁾ Dep. Edafología, Fac. Farmacia, USC, E-15782 Santiago de Compostela, Spain; ++34 981563100 ext. 14984; edgils@usc.es; edleiros@usc.es
Parameter	CM-cellulase activity
Soil type	All soil types
System	Laboratory
Method	Hydrolysis of carboximethyl-cellulose
Method description	Sieved moist soil is incubated with CM-cellulose solution for 24 h at 50°C and pH 5.5 (acetate buffer 2 M). After filtration and dilution of the assay mixture, the reducing sugars released are determined by the Prussian Blue colorimetric method and quantified by reference to a calibration graph constructed with glucose standards of different concentrations.
Do's, don'ts, potential limitations, untested possibilities	The filtered soil extracts must be diluted to avoid interference of ions with the reaction to measure the reducing sugars.
References	<i>Description of the method:</i> Schinner, F.; von Mersi, W. 1990. Xylanase, CM-cellulase and invertase activity in soil: an improved method. Soil Biology and Biochemistry 22: 511-515. <i>Comparison of different methods to determine reducing sugars:</i> Deng, S.P.; Tabatabai, M.A. 1994. Colorimetric determination of reducing sugars in soils. Soil Biology and Biochemistry 26: 473-477.
Additional information	Deng and Tabatabai (1994) showed that the Prussian blue method is one of the most sensitive and accurate to determine reducing sugars in soils.

ID	42_Trasar_Cepeda_g
Author	Trasar-Cepeda, C. ¹⁾ ; Gil-Sotres, F. ²⁾ ; Leirós, M.C. ²⁾ ¹⁾ IIAG-CSIC, Apartado 122, E-15780 Santiago de Compostela, Spain. ++34 981590958; ctrasar@iiag.cesga.es ²⁾ Dep. Edafología, Fac. Farmacia, USC, E-15782 Santiago de Compostela, Spain; ++34 981563100 ext. 14984; edgils@usc.es; edleiros@usc.es
Parameter	Dehydrogenase activity
Soil type	All soil types
System	Laboratory
Method	Reduction of INT to INTF
Method description	Sieved moist soil is incubated in the dark in a buffer solution (Tris-HCl buffer 1 M, pH 7.0) with a solution of 2- <i>p</i> -iodophenyl-3- <i>p</i> -nitrophenyl-5-phenyl-tetrazolium chloride (INT) during 1 h at 40°C. The red idonitrotetrazolium formazan (INTF) derived from reduction of INT is extracted with a 1:1 (vol:vol) <i>N,N</i> -dimethylformamide (DMF):ethanol solution and measured spectrophotometrically at 490 nm. The concentration of INTF formed is calculated by reference to a calibration graph obtained with different quantities of INTF.
Do's, don'ts, potential limitations, untested possibilities	<ul style="list-style-type: none"> • In soils with high organic matter content the INTF can be absorbed by the soil, giving erroneous results. To account for this adsorption, Camiña et al. (1998) suggested a modification of the method consisting on the correction for the adsorption of INTF by including soil in reference standards. • Both the pH of the soil-buffer-substrate mixture and the optimum pH for the activity should be checked for different soils. • The presence of copper in the soil decreases the absorbance of the INTF (Obbard, 2001), giving erroneous results of this parameter, and thus preventing the use of dehydrogenase activity as a measure of microbial activity in copper contaminated soils
References	<p><i>Description of the method:</i> von Mersi, W.; Schinner, F. 1991. An improved and accurate method for determining the dehydrogenase activity of soils with idonitrotetrazolium chloride. <i>Biology and Fertility of Soils</i> 11: 216-220.</p> <p><i>Modification of the method to account for the absorbance of INTF in some soils:</i> Camiña, F.; Trasar-Cepeda, C.; Gil-Sotres, F.; Leirós, C. 1998. Measurement of dehydrogenase activity in acid soils rich in organic matter. <i>Soil Biology and Biochemistry</i> 30: 1005-1011.</p> <p><i>Reduced absorbance of INTF and TPF in soils with presence of copper:</i> Chander, K.; Brookes, P.C. 1991. Is the dehydrogenase assay invalid as a method to estimate microbial activity in copper contamin. soils? <i>Soil Biol. Biochem.</i> 23: 909-915. Obbard, J.P. 2001. Measurement of dehydrogenase activity using 2-<i>p</i>-iodophenyl-3-<i>p</i>-nitrophenyl-5-phenyltetrazolium chloride (INT) in the presence of copper. <i>Soil Biology and Biochemistry</i> 33: 328-330.</p>
Additional information	<ul style="list-style-type: none"> • Other published methods use triphenyltetrazolium chloride (TTC) as the electron acceptor, which is reduced to triphenyl tetrazolium formazan (TTF). However, methods based on reduction of TTC have been reported to have lower sensitivity and poorer reproductibility than those based on reduction of INT. • As for INTF, the presence of copper in soils also reduces the absorbance of TPF (Chander and Brookes, 1991). • Different solutions (methanol, ethanol, 1:1.5 tetrachloroethylene-acetone, etc.) have been used to extract the formed INTF (or alternatively the TTF). von Mersi and Schinner (1991) used 1:1 DMF:ethanol, and Camiña et al. (1998) showed that this mixture is the most efficient to extract the INTF from soils.

ID	42_Trasar_Cepeda_h
Author	Trasar-Cepeda, C. ¹⁾ ; Gil-Sotres, F. ²⁾ ; Leirós, M.C. ²⁾ ¹⁾ IIAG-CSIC, Apartado 122, E-15780 Santiago de Compostela, Spain. ++34 981590958; ctrasar@iiag.cesga.es ²⁾ Dep. Edafología, Fac. Farmacia, USC, E-15782 Santiago de Compostela, Spain; ++34 981563100 ext. 14984; edgils@usc.es; edleiros@usc.es
Parameter	Invertase activity
Soil type	All soil types
System	Laboratory
Method	Hydrolysis of saccharose
Method description	Sieved moist soil is incubated with a saccharose solution for 3 h at 50°C and pH 5.5 (acetate buffer 2M). After filtration and dilution of the assay mixture, the reducing sugars released are determined by the Prussian Blue colorimetric method and quantified by reference to a calibration graph constructed with glucose standards of different concentrations.
Do's, don'ts, potential limitations, untested possibilities	The filtered soil extracts must be diluted to avoid interference of ions with the reaction to measure the reducing sugars.
References	<i>Description of the method:</i> Schinner, F.; von Mersi, W. 1990. Xylanase, CM-cellulase and invertase activity in soil: an improved method. Soil Biology and Biochemistry 22: 511-515. <i>Comparison of different methods to determine reducing sugars:</i> Deng, S.P.; Tabatabai, M.A. 1994. Colorimetric determination of reducing sugars in soils. Soil Biology and Biochemistry 26: 473-477.
Additional information	Deng and Tabatabai (1994) showed that the Prussian blue method is one of the most sensitive and accurate to determine reducing sugars in soils.

ID	42_Trasar_Cepeda_i
Author	Trasar-Cepeda, C. ¹⁾ ; Gil-Sotres, F. ²⁾ ; Leirós, M.C. ²⁾ ¹⁾ IIAG-CSIC, Apartado 122, E-15780 Santiago de Compostela, Spain. ++34 981590958; ctrasar@iiag.cesga.es ²⁾ Dep. Edafología, Fac. Farmacia, USC, E-15782 Santiago de Compostela, Spain; ++34 981563100 ext. 14984; edgils@usc.es; edleiros@usc.es
Parameter	Phosphodiesterase activity
Soil type	All soil types
System	Laboratory
Method	Hydrolysis of bis-<i>p</i>-nitrophenyl-phosphate
Method description	Sieved moist soil is incubated with a bis- <i>p</i> -nitrophenyl-phosphate solution at pH 8.0 (THAM buffer 0.05M) and 37°C for 1 h. After the addition of 0.5 M CaCl ₂ to prevent the dispersion of clay and the extraction of soil organic matter, the released <i>p</i> -nitrophenol is extracted with THAM-NaOH extractant solution (0.1M THAM, pH 12.0) and measured spectrophotometrically at 400 nm. The <i>p</i> -nitrophenol content of the extracts is calculated by reference to a calibration graph obtained with standards containing different quantities of <i>p</i> -nitrophenol.
Do's, don'ts, potential limitations, untested possibilities	<ul style="list-style-type: none"> • Both the pH of the soil-buffer-substrate mixture and the optimum pH for the activity should be checked for different soils. • In soils with a high organic matter content, the CaCl₂ concentration of the solution used to precipitate the dissolved organic matter should be increased • In soils with a high level of organic matter or receiving high inputs of organic fertilizers, it is necessary to check the <i>p</i>-nitrophenol adsorption by the soil in order to correct the obtained results if it is the case.
References	<p><i>Description of the analytical method:</i> Bowman, M.G.; Tabatabai, M.A. 1970. Phosphodiesterase activity of soils. Soil Science Society of America Journal 42: 284-290.</p> <p><i>The use of a CaCl₂ solution of higher concentration in soils with high organic matter content is indicated in:</i> García Izquierdo, C.; Gil Sotres, F.; Hernández Fernández, T.; Trasar Cepeda, C. 2003. Técnicas de análisis de parámetros bioquímicos en suelos. Medida de actividades enzimáticas y biomasa microbiana. Ediciones Mundi-Prensa, Madrid, 371 pp. (in Spanish).</p> <p><i>The problems associated with the adsorption of p-nitrophenol by soils are indicated in:</i> Vuorinen, A.H. 1993. Requirement of p-nitrophenol standard for each soil. Soil Biology and Biochemistry 25: 295-296.</p>
Additional information	In the method of Bowman and Tabatabai (1970), toluene is used to avoid the growth of microorganisms during the incubation. However, the use of toluene can cause diverse problems, so it is not always recommended. See, among others: Kaplan, D.L.; Hartenstein, R. 1979. Problems with toluene and the determination of extracellular enzyme activity in soils. Soil Biology and Biochemistry 11: 335-338. Skujins, J.J. 1967. Enzymes in Soil. In: McLaren, A.D.; Peterson, G.H. (eds.) Soil Biochemistry, vol. 1. Marcel Dekker, New York, pp. 371-414.

ID	42_Trasar_Cepeda_j
Author	Trasar-Cepeda, C. ¹⁾ ; Gil-Sotres, F. ²⁾ ; Leirós, M.C. ²⁾ ¹⁾ IIAG-CSIC, Apartado 122, E-15780 Santiago de Compostela, Spain. ++34 981590958; ctrasar@iiag.cesga.es ²⁾ Dep. Edafología, Fac. Farmacia, USC, E-15782 Santiago de Compostela, Spain; ++34 981563100 ext. 14984; edgils@usc.es; edleiros@usc.es
Parameter	Phosphomonoesterase activity
Soil type	All soil types
System	Laboratory
Method	Hydrolysis of <i>p</i>-nitrophenyl-phosphate
Method description	Sieved moist soil is incubated with a <i>p</i> -nitrophenyl-phosphate solution at pH 6.5 (Modified Universal Buffer) and 37°C for 1 h. After the addition of 0.5 M CaCl ₂ to prevent the dispersion of clay and the extraction of soil organic matter, the released <i>p</i> -nitrophenol is extracted with 0.5M NaOH solution and measured spectrophotometrically at 400 nm. The <i>p</i> -nitrophenol content of the extracts is calculated by reference to a calibration graph obtained with standards containing different quantities of <i>p</i> -nitrophenol.
Do's, don'ts, potential limitations, untested possibilities	<ul style="list-style-type: none"> • The MUB buffer is not very effective in keeping the pH of the soil-buffer system, thus the pH of the incubation mixture (soil-buffer-substrate) should be checked. • Both acid and alkaline phosphomonoesterase activity have been found in soils. Usually, it has been indicated that acid phosphomonoesterase is predominant in acid soils and alkaline phosphomonoesterase prevails in alkaline soils. Moreover, varying optimum pH values for both acid and alkaline activity have been indicated, and thus the optimum pH in different soils should be checked before the determination of this activity. • In soils with a high organic matter content, the CaCl₂ conc. of the solution used to precipitate the dissolved organic matter should be increased. This also implies the reduction of the concentration of NaOH to avoid the formation of precipitates. • In soils with a high level of organic matter or receiving high inputs of organic fertilizers, it is necessary to check the <i>p</i>-nitrophenol adsorption by the soil in order to correct the obtained results if it is the case.
References	<p><i>Description of the method:</i> Tabatabai, M.A.; Bremner, J.M. 1969. Use of <i>p</i>-nitrophenyl phosphate for assay of soil phosphatase activity. <i>Soil Biology and Biochemistry</i> 1: 301-307.</p> <p><i>The use of a CaCl₂ solution of higher concentration in soils with high organic matter content is indicated in:</i> García Izquierdo, C.; Gil Sotres, F.; Hernández Fernández, T.; Trasar Cepeda, C. 2003. Técnicas de análisis de parámetros bioquímicos en suelos. Medida de actividades enzimáticas y biomasa microbiana. Ediciones Mundi-Prensa, Madrid, 371 pp. (in Spanish).</p> <p><i>The problems associated with the ads. of p-nitrophenol by soils are indicated in:</i> Vuorinen, A.H. 1993. Requirement of <i>p</i>-nitrophenol standard for each soil. <i>Soil Biology and Biochemistry</i> 25: 295-296.</p>
Additional information	In the method of Tabatabai and Bremner (1969), toluene is added to the incubation mixture to avoid the growth of microorganisms during the incubation. However, the use of toluene can cause diverse problems and it is not always recommended. See, for example: Kaplan, D.L.; Hartenstein, R. 1979. Problems with toluene and the determination of extracellular enzyme activity in soils. <i>Soil Biology and Biochemistry</i> 11: 335-338. Skujins, J.J. 1967. Enzymes in Soil. In: McLaren, A.D.; Peterson, G.H. (eds.) <i>Soil Biochemistry</i> , vol. 1. Marcel Dekker, New York, pp. 371-414.

ID	42_Trasar_Cepeda_k
Author	Trasar-Cepeda, C. ¹⁾ ; Gil-Sotres, F. ²⁾ ; Leirós, M.C. ²⁾ ¹⁾ IIAG-CSIC, Apartado 122, E-15780 Santiago de Compostela, Spain. ++34 981590958; ctrasar@iiag.cesga.es ²⁾ Dep. Edafología, Fac. Farmacia, USC, E-15782 Santiago de Compostela, Spain; ++34 981563100 ext. 14984; edgils@usc.es; edleiros@usc.es
Parameter	Urease activity
Soil type	All soil types
System	Laboratory
Method	Hydrolysis of urea
Method description	Sieved moist soil is incubated with a solution of urea at 37°C and pH 7.1 (phosphate buffer 0.2 M) for 1.5 h. After the addition of 2M KCl, the released ammonium is measured with an ammonium electrode.
Do's, don'ts, potential limitations, untested possibilities	<ul style="list-style-type: none"> In the method described by Nannipieri et al. (1980), the released ammonium is determined by the colorimetric indophenol method, but it can be also determined by the ammonium electrode method, similarly to what is reported by these authors (in the same paper) for measurement of the ammonium released by the hydrolysis of <i>N</i>-benzoyl L-arginine amide (BAA). Both the pH of the soil-buffer-substrate mixture and the optimum pH for the activity should be checked for different soils.
References	Nannipieri, P.; Ceccanti, B.; Cervelli, S.; Matarese, E. 1980. Extraction of phosphatase, urease, proteases, organic carbon and nitrogen from soil. Soil Science Society of America Journal 44: 1011-1016.
Additional information	The released ammonium can be also determined by other different methods: distillation by Kjeldahl procedure, spectrophotometrically by the phenol sodium nitroprusside reaction, etc.

ID	42_Villnyi
Author	Villnyi, I.; Füzy, A.; Angerer, I.; Biró, B.. Research Institute for Soil Science and Agricultural Chemistry of the Hungarian Academy of Sciences (RISSAC), Lab. of Rhizobiology, POB: 35, H-1525, Budapest, Hungary; +36-1-2243-62; biro@rissac.hu
Parameter	Total catabolic enzyme activity of microbial communities
Soil type	Any soil
Plant species	All plants
Method	Fluorescein Diacetate Analysis (FDA)
Method description	<p>Since 1982, FDA hydrolysis has been used for the assessments of the total microbial activities in a range of samples, including the mould growth on woods (Bjurman, 1993), the plant residues (Zablotowicz et al., 1998), to stream sediment biofilms (Battin, 1997), the activated sludge (Fontvieille, 1992) and the deep sea clay and sand sediment profiles (Gumprecht et al., 1995). The advantage of this method is that it is simple, rapid and sensitive, coupled with the widespread acceptance of FDA hydrolysis as a measure of total microbial catabolic activities. Methodological optimisation has been performed therefore to a wide range of arable and technogenous soil samples.</p> <p><i>Method:</i> 2 g of fresh, stored or dry soil is used and sieved (2 mm). In the case of stored (frozen and defrosted) samples the water content is adjusted to 60 % ratio of the normal total water-holding capacity. After the watering, the samples are incubated for 7 days at 28 °C in the dark.</p> <p><i>Reagents - 60 mM potassium phosphate buffer, pH 7.6:</i> 8.7 g K₂HPO₄ (Sigma-Aldrich Co. Ltd, Analar) and 1.3 g KH₂PO₄ (Merck, BDH Analar) are dissolved in approximately 800 ml deionised water. The contents are made up to 1 l with deionised water. The buffer is stored in the fridge (at 4 °C) and the pH assessed on the day of the application.</p> <p><i>Reagents - 1000 mg FDA ml⁻¹ stock solution:</i> Fluorescein diacetate (0.1 g) (3'-6'-diacetyl-fluorescein (Sigma-Aldrich Co. Ltd) is dissolved in approximately 90 ml of acetone (Fisher Scientific UK Limited, analytical grade) and the contents of the flask are diluted up to 100 ml, by using acetone.</p> <p><i>Final procedure:</i> Two g of incubated soil is put into a 50 ml of conical flask and 30 ml of 60 mM potassium phosphate buffer pH 7.6 is added. Stock solution (0.2 ml 1000 mg FDA ml⁻¹) was added to start the reaction. Blanks are prepared without the addition of the FDA substrate along with a suitable number (3 or 5) of sample replicates. The flasks are stoppered and the contents shaken by hand. The flasks are then shaken in an orbital incubator at 30 °C, 200 rpm, for 120 minutes. After this procedure 0.8 ml acetone is added to 0.8 ml solution to terminate the reaction. The contents of the conical flasks is then transferred to 2.5 ml Eppendorf tubes and centrifuged at 3000 rpm for 3 minutes. The supernatant from each sample is then filtered (Whatman, No 2) and the filtrates measured</p>

	at 490 nm on a spectrophotometer. Control samples including acetone:buffer solution (1:1) at the measurements before estimating the FDA activities of each set of blanks and the samples.
Do's, don'ts, potential limitations, untested possibilities	For comparable measurements it is important to standardise the soil-application protocols. You can use three different approaches: <ol style="list-style-type: none"> 1. Use fresh soil, no later than 24 hours after sampling (stored & transported at 5 °C). In this case no pre-incubation is necessary. 2. Use frozen samples, stored in the freezer soon after sampling 3. Use soil samples, which are air-dried before measurement. The correct preincubation (described above) makes the results more comparable in this case.
References	<p>Battin, T.J. 1997. Assessment of fluorescein diacetate hydrolysis as a measure of total esterase activity in natural stream sediment biofilms. <i>Science of Total Environment</i> 198: 51-60.</p> <p>Biró, B.; Villányi, I.; Füzy, A.; Naár, Z. 2005. Bacterial and fungal colonisation in the rhizosphere of gen-modified (Bt-) and isogenic control corn. <i>Agrokemia Talajtan</i>, 54: 189-203. (<i>Hung. with Engl. abstract</i>)</p> <p>Bjurman, J. 1993. Determination of microbial activity in moulded wood by the use of fluorescein diacetate. <i>Material. Organismen</i> 28: 1-16.</p> <p>Gumprecht, G.; Gerlach, H.; Nehrkorn, A. 1995. FDA hydrolysis and resazurin reduction as a measure of microbial activity in sediments from the south-east Atlantic. <i>Helgoländer Meeresuntersuchungen</i> 49: 189-199.</p> <p>Fontvieille, D.A.; Outaguerouine, A.; Thevenot, D.R. 1992. Fluorescein diacetate hydrolysis as a measure of microbial activity in aquatic systems: application to activated sludges. <i>Environ. Technology</i> 13: 531-540.</p> <p>Zablotowicz, R.M.; Locke, M.A.; Smeda, R.J. 1998. Degradation of 2,4-D and fluometuron in cover crop residues. <i>Chemosphere</i> 37: 87-101.</p>
Links	www.taki.iif.hu/soilbiol.html
Additional Information	A good correlation has been found between the total countable microbes (heterotrophs) and FDA measurements. The method has been used to study the effect of genetically modified (<i>Bt</i>) maize among other rhizosphere parameters. More details in Biró et al. (2005) or from the authors.

ID	43_Artursson
Author	Artursson, V.; Jansson, J.K. Dept. of Microbiology, SLU, Box 7025, SE-750 07 Uppsala, Sweden ++46 - 18 - 67 32 01; Janet.Jansson@mikrob.slu.se
Parameter	Identification of bacterial communities in soil
Soil type	All kinds
Plant species	All kinds
System	Field soil , greenhouse studies, microcosms
Method	T-RFLP identification of bacterial communities
Method description	T-RFLP (Terminal-restriction fragment length polymorphism) provides a fingerprint of a microbial community and can be used to quantify the relative abundance of individual populations in a community. This method is ideal for monitoring community changes due to time or treatment. The first step is extraction of total DNA from an environmental sample. Then the 16S/18S rRNA genes or functional genes are amplified by PCR using universal primers for bacteria, archaea or eukarya, or specific primers to target certain groups. During PCR one or both of the primers are fluorescently labelled (eg. 5' primer). After PCR amplification, the amplified DNA fragments are digested using frequently cutting restriction enzymes. If putative identification of community members is a goal of the analyses it is usually necessary to do separate reactions with 3 different restriction enzymes. The restricted DNA fragments are separated on a sequencing gel or by capillary electrophoresis in an automated sequencer that detects fluorescently labeled molecules. The 5' terminal restriction fragments (TRFs) separated according to size (bp) on the gel/capillary are specifically detected due to their fluorescence. The fluorescence intensity of individual peaks correlates to the abundance of that particular TRF in the community DNA. By adding the total area of all of TRF peaks, it is possible to calculate the relative abundance of specific TRFs, corresponding to specific populations in the community. The resulting data (TRF presence and abundance) can be statistically analyzed using principal components analysis (PCA) or coordination analysis (CA) to compare different microbial communities, or changes in individual communities over time or treatment. For putative identification of individual populations, the TRF fragment lengths of ribosomal RNA genes resulting from 3 separate restriction enzyme digestions are compared to predicted TRF lengths of 16S/18S rRNA genes deposited in databases. If a microorganism of interest has a specific TRF, T-RFLP can be used to monitor the abundance of that population in the community.
Do's, don'ts, potential limitations, untested possibilities	In our experience T-RFLP is the best method currently available to obtain a quick and reliable fingerprint of a microbial community and to obtain quantitative data about the relative abundance of individual community members. This method is not the best available for identification of community members, due to the possibility of several microorganisms having the same TRF. This limitation is reduced by the use of 3 restriction enzymes, but identification in this manner is only putative and community members that have not been sequenced will not be included in existing databases. T-RFLP, together with other techniques relying on PCR amplification, also has the limitation that only dominant community members will be amplified and detected.

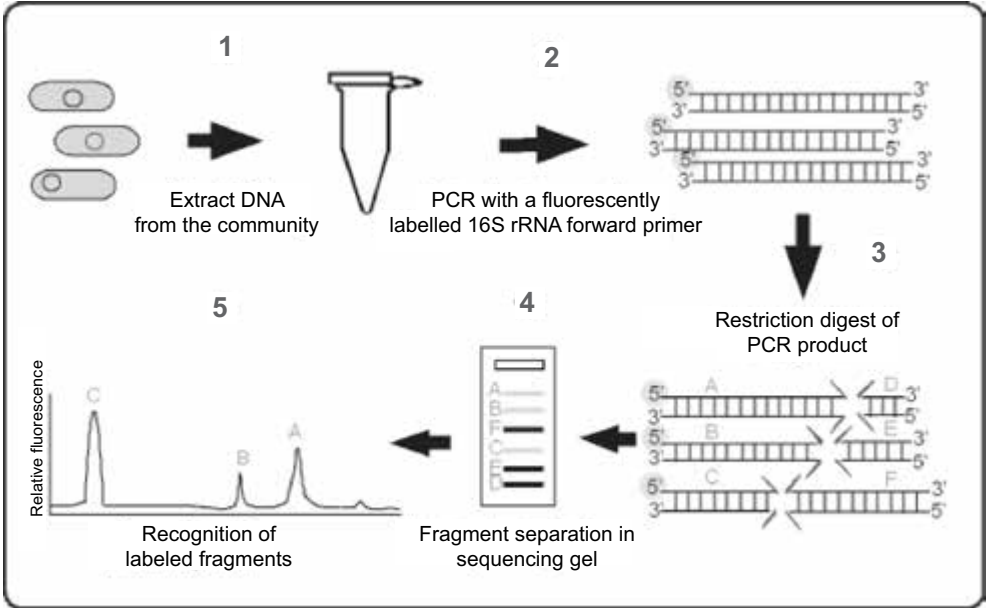
References	<p>Jernberg, C.; Jansson, J.K. 2002. Impact of 4-chlorophenol contamination and /or inoculation with the 4-chlorophenol-degrading strain, <i>Arthrobacter chlorophenolicus</i> A6L, on soil bacterial community structure. FEMS Microbiol. Ecol. 42: 387-397.</p> <p>Kennedy, N.; Brodie, E.; Connolly, J.; Clipson, N. 2004. Impact of lime, nitrogen and plant species on bacterial community structure in grassland microcosms. Environ. Microbiol. 6: 1070-1080.</p> <p>Liu, W.-T.; Marsh, T.L.; Cheng, H.; Forney, L.J. 1997. Characterization of microbial diversity by determining terminal restriction fragment length polymorphisms of genes encoding 16S rRNA. Appl. Environ. Microbiol. 63: 4516-4522.</p> <p>Osborn, A.M.; Moore, E.R.B.; Timmis, K.N. 2000. An evaluation of terminal-restriction fragment length polymorphism (T-RFLP) analysis for the study of microbial community structure and dynamics. Environ. Microbiol. 2: 39-50.</p>
Additional information	<p>Overview of T-RFLP method for community studies:</p>  <p>The diagram illustrates the T-RFLP method in five steps:</p> <ol style="list-style-type: none"> 1 Extract DNA from the community: Three bacterial cells are shown on the left, with an arrow pointing to a microcentrifuge tube. 2 PCR with a fluorescently labelled 16S rRNA forward primer: An arrow points from the tube to a set of three double-stranded DNA molecules. The top strand is labeled with '5'' and '3'' ends. 3 Restriction digest of PCR product: An arrow points down to a set of three DNA molecules that have been cut into six fragments labeled A through F. Each fragment has '5'' and '3'' ends indicated. 4 Fragment separation in sequencing gel: An arrow points to a gel electrophoresis image showing six horizontal bands labeled A through F. 5 Recognition of labeled fragments: An arrow points to a fluorescence profile graph with three peaks labeled C, B, and A. The y-axis is labeled 'Relative fluorescence'. <p>(V. Grüntzig, B. Stres, H. L. Ayala del Río, and J. M. Tiedje. Center for Microbial Ecology, Michigan State University, East Lansing, Michigan, 48824; website address: http://rdp.cme.msu.edu/html/t-rflp_jul02.html).</p>

ID	43_Bodrossy
Author	Bodrossy, Levente ARC Seibersdorf research GmbH, Division of Biogenetics & Natural Resources, Department of Bioresources/Microbiology A-2444 Seibersdorf, Austria ++43 50 550 3548; levente.bodrossy@arcs.ac.at
Parameter	Microbial presence and abundance
Soil type	any
Plant species	any
System	any
Method	Microbial diagnostic microarrays: target preparation and hybridisation
Method description	<p>For the design, creation and validation of microbial diagnostic microarrays, please refer to our online collection of protocols (see link below):</p> <p>In the following, the preparation of fragmented RNA targets for microarrays is described:</p> <p><i>PCR amplification of DNA sequence for in vitro transcription</i></p> <p>PCR with two primers: the primer of the strand to be labelled has to contain the T7 promoter site as well: 5'-TAATACGACTCACTATAG – ACTUAL PRIMER-3'. For environmental PCR, the standard is 250 ng template per 3x50 µl PCR reaction.</p> <p><i>In vitro transcription</i></p> <p>Per reaction, mix: 4 µl 5x T7 RNA polymerase buffer, 2 µl 100mM DTT, 0.5 µl 40 U/µl RNasin (Promega), 1 µl each of 10mM ATP, CTP, GTP, 0.5 µl 10mM UTP, 8 µl 50 ng/µl High Pure purified PCR product, 1 µl 5mM Cy3-UTP, 1 µl 40U/ul T7 RNA polymerase (Gibco BRL)</p> <p>Incubate at 37°C for 4 hours</p> <ol style="list-style-type: none"> 1. Add 7 µl of pmoA products into 1.5 µl Eppendorf tubes. 2. Prepare master mix; add RNA polymerase last. 3. Vortex; quickly add 13 µl aliquots of the master mix to the Eppendorf tubes with the pmoA template. 4. Brief spin, mix by gentle vortexing (careful not to split the 20 µl reaction volume into small drops; if this happens, spin again). 5. Incubate at 37°C for 4 hours. <p><i>RNeasy purification:</i></p> <p>To remove unincorporated nucleotides and DNA.</p> <ol style="list-style-type: none"> 1. Add 80µl DEPC treated water to the IVT mix. 2. Add 350µl RLT; mix thoroughly. 3. Add 250µl EtOH; mix thoroughly. 4. Sample (700µl) into an RNeasy mini column. 15 secs at >10.000 rpm. 5. Transfer column into a new 2ml collection tube. Add 500µl RPE, 15 secs at >10.000 rpm. 6. Add 500µl RPE, 2 minutes at >10.000 rpm.

	<p>7. Transfer column into a 1.5 ml collection tube. Add 50µl RNase free water. Incubate for 1 minute at >10.000 rpm. Transfer the eluate into a new 1.5 ml Eppendorf tube.</p> <p><i>Zn²⁺ fragmentation of RNA</i></p> <p>Preparation of about 25mM Tris-Cl pH 7.4, 10mM Zn as follows:</p> <table border="1"> <tr> <td>50 µl</td> <td>purified RNA (diluted with DEPC water if needed) (about 40 ng/µl)</td> </tr> <tr> <td>1.43 µl</td> <td>1M Tris.Cl pH 7.4</td> </tr> <tr> <td>5.71 µl</td> <td>100mM ZnSO₄</td> </tr> </table> <p>Mix; → 60°C, 30 minutes. <i>Note:</i> use dry block and do not mix during the incubation because the condensation on the lid of the tube is also included in the optimisation of the protocol (causes gradual concentrating of the reaction thus influencing efficiency).</p> <p>→ + 1.43 µl 500mM EDTA to remove Zn(II) from solution; onto Ice; add 1 µl 40 U/µl Rnasin!</p> <p>--> Final volume and concentrations: 60µl, 9.5mM Zn, 24mM Tris, 12 mM EDTA</p> <p><i>Hybridisation</i></p> <table border="1"> <tr> <td>137 µl</td> <td>DEPC-water</td> </tr> <tr> <td>2.21 µl</td> <td>10% SDS</td> </tr> <tr> <td>4.42 µl</td> <td>50x Denhardt's reagent</td> </tr> <tr> <td>66.9 µl</td> <td>20x SSC</td> </tr> <tr> <td>10 µl</td> <td>target RNA from 0°C</td> </tr> </table> <p>→ 65°C (Eppendorf incubator), 1 min</p> <p>→ into a 200 µl Hybriwell hyb. chamber stuck onto the slide (incubated on top of the incubator for 1 min).</p> <p>→ shaken O/N on top of an aluminium block in a Belly Dancer. T=55 °C, rpm=slow, bend=max.</p> <table border="1"> <tr> <td> <p><i>Wash:</i> <i>Note:</i> when hyb.chamber is removed, slides must be put into the first wash solution immediately!</p> </td> <td> <ul style="list-style-type: none"> • 5 mins in 2xSSC, 0.1% SDS at RT, shaken • 2x5 mins in 0.2x SSC, shaken • 5 mins in 0.1x SSC, shaken • Blow dry with airgun; scan as soon as possible </td> </tr> </table> <p>Hyb: 6xSSC = 1 M Na; 475 nM Zn(II) - chelated by 600 nM EDTA..</p>		50 µl	purified RNA (diluted with DEPC water if needed) (about 40 ng/µl)	1.43 µl	1M Tris.Cl pH 7.4	5.71 µl	100mM ZnSO ₄	137 µl	DEPC-water	2.21 µl	10% SDS	4.42 µl	50x Denhardt's reagent	66.9 µl	20x SSC	10 µl	target RNA from 0°C	<p><i>Wash:</i> <i>Note:</i> when hyb.chamber is removed, slides must be put into the first wash solution immediately!</p>	<ul style="list-style-type: none"> • 5 mins in 2xSSC, 0.1% SDS at RT, shaken • 2x5 mins in 0.2x SSC, shaken • 5 mins in 0.1x SSC, shaken • Blow dry with airgun; scan as soon as possible
50 µl	purified RNA (diluted with DEPC water if needed) (about 40 ng/µl)																			
1.43 µl	1M Tris.Cl pH 7.4																			
5.71 µl	100mM ZnSO ₄																			
137 µl	DEPC-water																			
2.21 µl	10% SDS																			
4.42 µl	50x Denhardt's reagent																			
66.9 µl	20x SSC																			
10 µl	target RNA from 0°C																			
<p><i>Wash:</i> <i>Note:</i> when hyb.chamber is removed, slides must be put into the first wash solution immediately!</p>	<ul style="list-style-type: none"> • 5 mins in 2xSSC, 0.1% SDS at RT, shaken • 2x5 mins in 0.2x SSC, shaken • 5 mins in 0.1x SSC, shaken • Blow dry with airgun; scan as soon as possible 																			
Links	http://www.diagnostic-arrays.com/approach.htm .																			

ID	43_Brunner
Author	Brunner, Ivano Swiss Federal Institute of Forest, Snow and Landscape Research WSL CH-8903 Birmensdorf, Switzerland ivano.brunner@ws.ch; ++41 44 739 22 84
Parameter	Identification of tree fine roots
Soil type	Forest soils
Plant species	All tree species from Central Europe, including pine, spruce, larch, fir, beech, oak, chestnut, alder, poplar, maple, ash, elm, and others.
System	Molecular identification with the trnL intron of plastid DNA
Method	PCR amplification and RFLP analysis of fine root DNA
Method description	<p><i>Extraction of DNA:</i> Disperse 30 mg of lyophilised and ground root powder in 650 µL of extraction buffer (100 mM Tris-HCl pH 8.0, 25 mM EDTA, 2 M NaCl, 2% (w/v) hexadecyltrimethylammonium bromide (CTAB), 500 µL/L spermidine, 2% (w/v) polyvinylpyrrolidone K30 (PVP), 5% (w/v) PVPP, supplemented with 2% (v/v) b-mercaptoethanol); Incubate for 30 min at 65°C in a shaking water bath; Add an equal volume of chloroform/isoamylalcohol (24:1); Mix the extract thoroughly and centrifuge for 10 min at 10,000 x g; Transfer the aqueous phase to a new tube, and repeat the chloroform/isoamylalcohol extraction; Precipitate the DNA by addition of 1.5 volumes of isopropanol and incubate the mixture for at least 1 h at -20°C.; Recover the DNA by centrifugation for 30 min at 20,000 x g, wash with 70% chilled ethanol; Dissolve the DNA in 150 µl TE (10 mM Tris-HCl pH 8.4, 1 mM EDTA) by a 5-min incubation at 65°C; Quantify the DNA content fluorometrically.</p> <p><i>PCR:</i> Perform PCR amplifications using the primers c and d (primer c: CGAAATCGGTAGACGCTACG, primer d: GGGGATAGAGGGACTTGAAC) according to Brunner et al. (2001). PCR profile: 3 min denaturation at 94°C and 40 cycles of 1 min denaturation at 94°C, 1 min annealing at 57°C, 2 min extension at 72°C, followed by a final extension at 72°C for 10 min.</p> <p><i>RFLP:</i> see Brunner et al. (2001).</p>
Do's, don'ts, potential limitations, untested possibilities	Common protocols for the extraction of the DNA from roots of woody plants do not work, because these tissues contain high amounts of phenolic substances and tannins which interact with the extraction and the PCR procedures.
References	Brunner, I.; Brodbeck, S.; Büchler, U.; Sperisen, C. 2001. Molecular identification of fine roots of trees from the Alps: Reliable and fast DNA extraction and PCR-RFLP analyses of plastid DNA. <i>Molecular Ecology</i> 10: 2079-2087.
Links	http://www.wsl.ch/staff/ivano.brunner/project_ident_root_en.ehtml

Additional information

Table 1. Main key for the identification of the main tree species from Central Europe.

Taq I ¹⁾	1 ²⁾	512-532 ³⁾				<i>Taxus baccata</i> ⁴⁾
		394-414				<i>Betula pendula</i>
	2	389-413	135-156			A ⁵⁾
		364-385	93-113			C
		305-335	200-220			D
		286-306	243-263			<i>Acer pseudoplatanus</i>
		222-262	122-164			E
		3	333-353	117-137	79-99	
	236-275		117-145	78-119		F
	243-263		144-164	130-150		<i>Acer campestre</i> , <i>Acer platanoides</i>
	235-255		157-177	88-108		<i>Ulmus glabra</i>
	215-238		200-220	77-102		G

¹⁾Restriction enzyme, ²⁾Number of fragments, ³⁾Fragmentsize, ⁴⁾Species, ⁵⁾Side key

Table 2. Side keys A to G for the identification of the main tree species.

A	Rsa I ¹⁾	1 ²⁾	596-616 ³⁾				<i>Carpinus betulus</i> ⁴⁾
			293-315				B ⁵⁾
		3	303-323	172-192	106-126		<i>Fagus sylvatica</i>
B	Hinf I	3	181-210	140-160	90-110		<i>Alnus glutinosa</i> , <i>Alnus incana</i>
		4	181-210	140-160	90-110	79-99	<i>Alnus viridis</i>
C	Cfo I	1	549-569				<i>Castanea sativa</i>
		2	369-389	169-189			<i>Quercus petraea</i> , <i>Quercus robur</i>
D	Hinf I	2	175-195	90-110			<i>Picea abies</i>
		3	166-186	99-119	90-110		<i>Pinus cembra</i>
		4	166-186	127-147	103-123	90-110	<i>Pinus mugo</i> , <i>Pinus sylvestris</i>
E	Rsa I	1	613-633				<i>Tilia cordata</i> , <i>Tilia platyphyllos</i>
			538-558				<i>Fraxinus excelsior</i>
			284-306				<i>Prunus avium</i>
F	Rsa I	1	659-682				<i>Populus nigra</i> , <i>Populus tremula</i>
			284-306				<i>Sorbus aucuparia</i>
G	Hinf I	3	168-188	130-150	90-110		<i>Abies alba</i>
			167-187	90-110	85-105		<i>Larix decidua</i>
		4	167-187	103-123	90-110	85-105	<i>Pseudotsuga menziesii</i>

¹⁾Restriction enzyme, ²⁾Number of fragments, ³⁾Fragmentsize, ⁴⁾Species, ⁵⁾Side key

ID	43_Corgie
Author	Corgié, Stéphane; Beguiristain, Thierry; Leyval, Corinne (corresp. author) LIMOS (Laboratoire des Interactions Microorganismes-Minéraux-Matière Organique dans les Sols), UMR 7137 CNRS-UHP Nancy I, Faculté des Sciences, BP239, 54506 Vandoeuvre-les-Nancy Cedex, France corinne.leyval@limos.uhp-nancy.fr; ++33 3 83 68 42 82
Parameter	Bacterial community structure
Soil type	PAH-spiked sand
Plant species	Lolium perenne
System	Compartment device. See 11_Corgie
Method	PCR-TGGE
Method description	Isolation of total DNA, was based on a bead beating lysis and a phenol/chloroform purification. The eubacterial primer set, 968f and 1401r, was used to amplify using PCR a 475 bp fragment of the 16S rDNA. TGGE was performed with a Dcode Universal Mutation Detection System (Biorad) with polyacrylamide gels (6% (wt/vol) acrylamide, 0,21% (wt/vol) bisacrylamide, 8M urea, 1.25X TAE and 0.2% (vol/vol) glycerol). DNA samples (5 µl) were separated by electrophoresis in 1.25X TAE at a constant voltage (100V), with a temperature gradient from 57 to 67°C (temperature increment of 0.7°C per hour). After electrophoresis, gels were stained with ethidium bromide, and numerized under UV light. Quantification of band mobility and band intensity was determined using Kodak 1D 3.5.2. software. Community similarities between TGGE profiles, based on the relative band intensity, were analysed by Principal Component Analysis.
Do's, don'ts, potential limitations, untested possibilities	<i>DNA isolation procedure</i> One critical point of the technique is the purity of the DNA isolated from samples. DNA extract has to be free of PCR inhibitors. In this study, DNA was isolated from sand samples and no inhibition of the PCR amplification was observed but several other studies showed that DNA isolated from soil, especially contaminated soils, could contain PCR inhibitors. The procedure has to be adapted to specific soil properties. <i>TGGE conditions</i> The technique uses a thermal gradient to discriminate different DNA molecules amplified by PCR during acrylamide gel electrophoresis. One advantage of the technique is that the temperature gradient is easily determined with MacMelt software provided by the manufacturer using homologous sequences present in databases. <i>Gel analysis</i> In the gels, a band pattern is determined for each sample and in principle, each band is characteristic to a single DNA sequence. One limitation of the method is the limit of detection of the bands present in the gels. In this study, bands were detected in gels after staining with ethidium bromide, and numerisation under UV light. This technique was sufficient to compare contrasted samples but techniques more sensitive like silver staining could also be used to detect less abundant bands. One other advantage of the method is that bands of interest can be extracted from the gel, sequenced and compared to sequences available in Genbank database (Blastn software) to determine the identity of microorganisms present in the samples. <i>PCR-TGGE</i> This method is easy to use, non expensive and allows to compare rapidly a great number of samples.
References	Corgié, S.; Beguiristain, T.; Leyval, C. 2004, Spatial distribution of bacterial communities and phenanthrene degradation in the rhizosphere of <i>Lolium perenne</i> L. Appl. Environ. Microbiol. 70: 3552-3557.

ID	43_Grebenc
Author	Grebenc, Tine; Kraigher, Hojka Slovenian Forestry Institute, Vecna pot 2, 1000 Ljubljana, Slovenia ++386 1 200 7800; tine.grebenc@gozdis.si; hojka.kraigher@gozdis.si
Parameter	Identification and characterisation of types of ectomycorrhiza
Soil type	Forest soils
Plant species	Spruce, beech, silver fir, pine, alder, oak
System	<i>In situ</i> - Forest ecosystems
Method	Anatomical and molecular identification and quantification of types of ectomycorrhiza
Method description	<p><i>Method description:</i></p> <ol style="list-style-type: none"> 1) <i>Standardized sampling</i> (Agerer, 1991): soil core of known volume (in Slovenia 270 ml, 0-18 cm deep); storage and soaking (overnight) at 4°C; careful cleaning of all roots in a tray, using binocular. 2) <i>Differentiation</i> of non-mycorrhizal root tips, old and non-turgescient ECM and vital ECM; differentiation of vital morphotypes under stereomicroscope (after morphology & mantle characteristics). 3) <i>Identification</i> of types of ECM: anatomical and molecular identification. 4) <i>Database up-grading</i>: inclusion of voucher specimen, microscope photographs and molecular patterns / sequences into the respective databases. 5) <i>Quantification</i> (Agerer, 1991): counting of root tips of all non-mycorrhizal, old un-identifiable types and of all vital ECM types. Due to the use of the standardized soil core volume the total numbers, percentages and any diversity indexes can be compared between sites. <p><i>Ad 3) Anatomical characteristics</i> (Agerer, 1991; Kraigher and Agerer, 2000): Descriptions of morphological characteristics of ectomycorrhizae (type of ramification, colour, surface view of mantle, emanating elements), anatomical characteristics of the mantle structure, emanating elements (hyphal characteristics, septa, anastomosing, differentiation and growth characteristics of rhizomorphs (term rhizomorph used after Agerer, 1991)) and the Hartig net in mantle preparations (scrapings), selected chemical colour reactions; for comprehensive characterisation also: analyses of longitudinal and cross-sections, autofluorescence of whole mycorrhiza and its sections, colour reactions and additional features (number of nuclei, siderophilous granules etc.).</p> <p><i>Ad 3) Molecular methods</i> (Martín, 2000ab; Winka et al., 1998; Kårén et al., 1997): Extraction of DNA (brush-cleaned 1 to 10 ECM tips) using CTAB or Plant Dneasy Mini Kit (QIAGEN), amplification of the ITS region (using primers ITS1f + ITS4b for basidiomycetes, ITS1f + ITS4 for ascomycetes, from http://plantbio.berkeley.edu/~bruns/; amplification after Martín (2000ab), Martín and Kårén (2000) or using Ready-To-Go™ PCR Beads (Amersham-Pharmacia Biotech, Piscataway, NJ, USA) as mentioned in Winka et al. (1998); restriction using 3 enzymes (<i>Hinf1</i>, <i>Mbo1</i>, <i>Taq1</i>) after Kårén et al. (1997).</p> <p><i>Ad 4) Database up-grading</i> (Kraigher and Agerer, 2000; Grebenc and Kraigher, 2000; Grebenc et al., 2000; Martín and Kårén, 2000): PCR-</p>

	ITS-RFLP database was published by Grebenc et al. (2000) and Grebenc and Kraigher (2000) as described in Martín and Kårén (2000); at present it contains ca 450 isolates of identified fungal fruitbodies and 250 patterns from ECM; sequencing (after Martín, 2000ab) done for samples which do not coincide with any patterns in the RFLP database after purification of the amplified product with commercial kits; DNA sequenced in automated sequencer (ABI Prism 310); sequences aligned and compared using BLAST with GenBank and Unite.
Do's, don'ts, potential limitations, untested possibilities	Anatomical identification is longlasting and expertise demanding; it can be speeded up by the addition of the molecular identification. However after sequencing ca 20% ECM can still remain un-identified due to the lack of reference sequences in GenBank and Unite.
References	<p>Agerer, R. 1991. Characterisation of ectomycorrhiza. In: Norris, J.R.; Read, D.J.; Varma, A.K. (eds.) Techniques for the study of mycorrhiza. Methods in microbiology 23, Academic Press, London, pp. 25-73.</p> <p>Kraigher, H.; Agerer, R. 2000. Identification and characterisation of types of ectomycorrhizae. In: Martín, M.P. (ed.) Methods in root-soil interactions research protocols. Slovenian Forestry Institute, Ljubljana, Slovenia, pp. 19-24.</p> <p>Martín, M.P. 2000a. Protocols: DNA isolation, PCR and RFLP analyses. In: Martín, M.P. (ed.) Methods in root-soil interactions research protocols. Slovenian Forestry Institute, Ljubljana, Slovenia, pp. 35 –44.</p> <p>Martín, M.P. 2000b. PCR and automated DNA sequencing. In: Martín, M.P. (ed.) Methods in root-soil interactions research protocols. Slovenian Forestry Institute, Ljubljana, Slovenia, pp. 49 – 52.</p> <p>Winka, K.; Ahlberg, C.; Eriksson, O.E. 1998. Are there lichenized ostropales?. Lichenologist 30 (4-5): 455-462.</p> <p>Kårén, O.; Hogberg, N.; Dahlberg, A.; Jonsson, L.; Nylund, J.-E. 1997. Inter- and intraspecific variation in the ITS region of rDNA of ectomycorrhizal fungi in Fennoscandia as detected by endonuclease analysis. New Phytol. 136: 313-325.</p> <p>Grebenc, T.; Kraigher, H. 2000. Establishment of the PCR-ITS-RFLP database for mycorrhizal fungi and types of ectomycorrhizae on Norway spruce from the permanent forest research plot of the Slovenian Forestry Institute on Pokljuka. In: The Rhizosphere, Professional and Scientific Works 118: 179-190; SFI, Ljubljana, Slovenia. (<i>in Slovene with English abstract</i>)</p> <p>Grebenc, T.; Piltaver, A.; Kraigher, H. 2000. Establishment of the PCR-RFLP library for Basidiomycetes, Ascomycetes and their ectomycorrhizae on <i>Picea abies</i> (L.) Karst. Phytol. Annales rei botanicae (Horn, Austria), 40(4): 79-82.</p> <p>Martín, M.P.; Kårén, O. 2000. Taxotron and DNA databases for identification of ectomycorrhizae. In: Martín, M.P. (ed.) Methods in root-soil interactions research protocols. Slovenian Forestry Institute, Ljubljana, Slovenia, pp. 45 – 48.</p>
Links	www.gozdis.si

ID	43_Jansa_a
Author	Jansa, Jan ETH Zurich, Plant Sciences, Eschikon 33, CH – 8315 Lindau (ZH), Switzerland; jan.jansa@ipw.agrl.ethz.ch; ++41 52 3549216
Parameter	Cloning and sequencing of AMF DNA
Plant species	any AMF host plant, better: non-woody roots
System	field samples, pot experiments
Method	DNA extraction, PCR amplification, cloning and sequencing from the arbuscular mycorrhizal fungal (AMF) spores and roots
Method description	<p>AMF spore(s) is crushed in 10 µl of sterile water in PCR vials by flamed Pasteur pipette. Immediately, 10 µl of the 20% Chelex-100 (Biorad) suspension is added (or 10 µL of Chelex and 30 µL of 100mM Tris buffer pH 8.0). The sample is heated at 95°C for 1-3 min. Samples are transferred on ice for 10 min, and 5µL is used as template for PCR amplification. Extraction of DNA from roots is most reliably done by using kits (Sigma or MoBio or Qiagen).</p> <p>Run PCR with desired primers. Remember possible interferences with other DNA present in the sample (e.g. DNA extraction from mycorrhizal roots contains a lot of plant DNA and AMF DNA is only in minority). Check PCR amplification on agarose gel of appropriate strength (0.8% agarose is fine for most amplicon lengths).</p> <p>PCR product should be purified from other PCR reaction components either by re-extraction from the gel or by using a specific kit from Qiagen. Amplified DNA is then inserted into linearized vector (such as P GEM-T Easy from Promega, containing multiple cloning site) and inserted into competent cells of <i>E.coli</i>. Because the cloning vector contains genetical basis for antibiotic resistance, positively transformed clones are selected on bacterial media containing antibiotics (e.g. ampicillin for P GEM-T Easy vector).</p> <p>PCR with primers targeted to multiple cloning site of the vector will provide the ultimate proof of presence of cloned PCR amplicon in the vector – this step is important because the vector could also be empty.</p> <p>Bacterial culture containing desired DNA molecule is grown overnight and plasmid DNA is extracted by Miniprep procedure (see Sambrook et al. 1989; kits available from various companies). DNA is sequenced according to the sequencing hardware available.</p>
Do's, don'ts, potential limitations, untested possibilities	<ul style="list-style-type: none"> • For non-pigmented spores, you can omit Chelex addition to the extraction solution. It helps mostly to remove/inactivate phenolic compounds that would interfere with the PCR reaction. • Keeping the samples on the ice for most of the time will ensure a good quality of the DNA (through lowering the activity of lytic enzymes released by the homogenization of the spores). • Sequencing data are useful for ensuring phylogenetic position of unknown AMF strain, but also may be used for designing specific PCR probes for in-situ identification of AMF or other applications. • There is much less information available for non ribosomal DNA regions from the AMF probably due to lower number of non ribosomal DNA copies

	in their genome.
References	<p><i>DNA extraction from AMF spores:</i> Sanders, I.R.; Alt, M.; Groppe, K.; Boller, T.; Wiemken, A. 1995. Identification of ribosomal DNA polymorphisms among and within spores of the Glomales: application to studies on the genetic diversity of arbuscular mycorrhizal fungal communities. <i>New Phytologist</i> 130: 419-427.</p> <p><i>Comprehensive guide for PCR and cloning procedures:</i> Sambrook, J.; Fritsch, E.F.; Maniatis, T. 1989. <i>Molecular Cloning: A Laboratory Manual</i>. Cold Spring Harbor Laboratory Press, NY, Vol. 1, 2, 3.</p> <p><i>Nested PCR for amplification of AMF DNA from roots:</i> VanTuinen, D.; Jacquot, E.; Zhao, B.; Gollotte, A.; Gianinazzi-Pearson, V. 1998. Characterization of root colonization profiles by a microcosm community of arbuscular mycorrhizal fungi using 25S rDNA- targeted nested PCR. <i>Molecular Ecology</i> 7: 879- 887.</p> <p><i>Specific primers for several AMF species/genera to amplify AMF DNA from roots:</i> Jansa, J.; Mozafar, A.; Kuhn, G.; Anken, T., Ruh, R.; Sanders, I.R.; Frossard, E. 2003. Soil tillage affects the community structure of mycorrhizal fungi in maize roots. <i>Ecological Applications</i> 13: 1164-1176.</p>
Links	<p>www.dijon.inra.fr/bbceipm/Mychintec/Protocole/Workshop_Procedures.html</p> <p>plantbio.berkeley.edu/~bruns/primers.html</p>
Additional information	detailed protocols available from the author

ID	43_Jansa_b
Author	Jansa, Jan ETH Zurich, Plant Sciences, Eschikon 33, CH – 8315 Lindau (ZH), Switzerland; jan.jansa@ipw.agrl.ethz.ch; ++41 52 3549216
Parameter	SSCP fingerprinting
Plant species	maize, wheat
System	field samples, pot experiments
Method	Assessment of sequence composition/diversity of arbuscular mycorrhizal fungal (AMF) DNA by single strand conformation polymorphism (SSCP) analysis
Method description	<p>This method describes how to perform single-stranded-conformation-polymorphism (SSCP) analysis of DNA fragments generated by PCR. This is a fingerprinting technique allowing visualizing difference of up to a single nucleotide within a fragment of 150 to 300 base pairs (bp) long. The double stranded DNA is split to single strands which fold in according to their nucleotide sequence composition. The migration in electrical field allows separation of different spatial conformations of the single stranded DNA.</p> <p>After PCR generating fragments 150-300 bp (for optimal results do not use fragments longer than 350-400 bp), take 3 μl of your reaction mix (you may add 1 μL of Bromophenol Blue, 10 μg/mL for better visualisation) and add 7μL of formamide containing 10 mM NaOH (mix always just before the SSCP run otherwise this mixture will be decayed), fill into PCR plate. Heat in the PCR machine at 95°C for 5 min, and place quickly on ice and incubate for 5 min. Load 4 to 8μL aliquots onto pre-cooled (5°C) SSCP pre-cast gels (e.g. GMATM Wide Mini S-26, Elchrom Scientific, Cham, Switzerland), TAE buffer 30 mM, and resolve in Elchrom SEA-2000 electrophoresis apparatus at 5 V cm^{-1} for 16 hours (low temperature limit 3.5°C, high limit 9.1 °C). Stain the gels with SYBR Gold II dye (Molecular Probes Inc., Eugene OR, USA) (1:10000 in 10mM TAE) for 40 min. Photograph on a short-wave, 254 nm transilluminator (Elchrom). Interpretation of the SSCP profiles needs to be chosen according to the goals of the study. Refer to specialized lit. on this.</p>
Do's, don'ts	Take care that you are using the short wave transilluminator. This is quite necessary, because the staining will not be much stronger than ethidium bromide staining when viewed under 360 nm. Under 254nm, however, the sensitivity is 1-2 orders of magnitude better.
References	<p><i>Use of SSCP in assessing diversity of ribosomal DNA in AMF spores:</i> Jansa, J.; Mozafar, A.; Banke, S.; McDonald, B.A.; Frossard, E. 2002. Intra- and intersporal diversity of ITS rDNA sequences in <i>Glomus intraradices</i> assessed by cloning and sequencing, and by SSCP analysis. <i>Mycological Research</i> 106: 670-681.</p> <p><i>Thermodynamic basis of SSCP (single stranded DNA folding):</i> Nielsen, D. A.; Novoradovsky, A.; Goldman, D. 1995. SSCP primer design based on single-strand DNA structure predicted by a DNA folding program. <i>Nucleic Acids Research</i> 23: 2287-2291.</p> <p><i>SSCP for identification of haplotypes, use in population genetics:</i> Orti, G.; Hare, M.P.; Avise, J.C. 1997. Detection and isolation of nuclear haplotypes by PCR-SSCP. <i>Molecular Ecology</i> 6: 575-580.</p> <p><i>SSCP can be useful in assessing point mutations:</i> Sheffield, V.C.; Beck, J.S.; Kwitek, A.E.; Sandstrom, D.W.; Stone, E.M. 1993. The sensitivity of single-strand conformation polymorphism analysis for the detection of single base substitutions. <i>Genomics</i> 16: 325-332.</p>

ID	43_Ködöböcz
Author	Ködöböcz, L.; Mogyoróssy, T.; Halbritter, A.; Biró, B. Research Institute for Soil Science and Agricultural Chemistry of the Hungarian Academy of Sciences (RISSAC), Lab. of Rhizobiology, POB: 35, H-1525, Budapest, Hungary; ++36-1-2243-627; biro@rissac.hu
Parameter	Diversity assessment of <i>Rhizobium loti</i> populations
Plant species	Leguminous plants (<i>Rhizobium</i> bacteria, isolated from the root nodules of the hosts)
Method	BOX-PCR gel-electrophoresis
Method description	<p><i>Sample preparation</i> <i>Rhizobium</i> isolates of <i>Lupinus albus</i>, originating from two different soils with contrasting agricultural practices were grown on YMA (Yeast extract Mannitol Agar) slants for 24 h. 0.85% KCl solution was prepared with distilled water, aliquoted (1-1 ml) into 1.5 ml Eppendorf tubes and sterilised by autoclaving. One loopful from a 24-h <i>Rhizobium</i> culture was added into such a tube, and suspended. Cells were sedimented by centrifugation (2-3000 rpm, 2-3 min) and the KCl solution decanted with a swift move. The remaining solution was collected by additional centrifugation, and removed by pipetting without removing the pin's head amount of cells in the bottom of the tube. (This washing step is generally useful to remove the polysaccharide sheath of the cells, which might be disturbing in later steps.) 1 ml of sterile distilled water was added to each tube and the cells were resuspended by vortexing, after which the suspensions were frozen at -20°C. They were left in the freezer until preparation of the PCR mixture.</p> <p><i>PCR reaction</i> A premix was prepared by keeping the premix tube in an ice rack at near 0°C throughout the preparation and combining the following reagents to obtain a final reaction volume of 25 µl per sample: 6.35 ml of HPLC-grade H₂O, 2.50 ml of 10x Goldstar reaction buffer (Eurogentec), 2.50 ml of DMSO (SIGMA), 6.35 ml of 5 mM MgCl₂ solution (Promega), 1.00 ml of 3% BSA solution (SIGMA), 2.50 ml of mixed dNTP solution (12.5 mM for each dNTP) (Promega), 2.50 ml of 60 mM BOX-A1R (5'-CTACGGCAAGGCGACGCTGACG-3') solution (MWG-Biotech AG, Germany) and 0.30 ml of 5 U/ml Taq polymerase solution (Promega) taken right from the freezer (-20°C) and kept in a separate ice rack between manipulations at 0°C. 24-24 µl of this premix were aliquoted into separate 200 µl micro test tubes (BIO-RAD) kept in an ice-rack near 0°C. From each sample, 1.00 ml of suspended cell matter (prepared as described above) was added to a premix-containing micro test tube. The tubes were inserted into the preheated (90 °C) thermal cycler (I-CYCLER from BIO-RAD, 96 wells, used in algorithmic temperature measuring mode), programmed as: 95°C initial denaturation for 2 min, followed by 35 cycles of 94°C intermediate step for 3 sec, 92°C denaturation for 30 sec, 49°C annealing for 1 min, 65°C elongation for 8 min, and closed by a final elongation at 65°C for 8 min. Products were kept by the thermal cycler at 4°C until removal from the block, stored in the refrigerator at 4°C, and subjected for the electrophoresis step as soon as possible.</p> <p><i>Gel-electrophoresis</i> A Sub Cell GT agarose gel electrophoresis system (BIO-RAD) was used.</p>

	<p>The electrophoresis system is connected to a PowerPac 300 (BIO-RAD) power supply. Stained gels are visualized on a GVSM20 Trans-illuminator (SYNGENE) and the DNA fragment patterns captured with a KODAK DC290 Zoom Digital Camera mounted on a DigiDoc (BIO-RAD) support hood. 1.5% agarose gel (20 cm x 15 cm x 0.8 cm) in TBE buffer with 20 wells was made fresh before use and placed into the precooled buffer chamber (4-10°C), in the first, middle and last wells 4 ml of 100 bp DNA ladder (PROMEGA), in the other wells 10 ml of PCR product were loaded with 3-3 ml of loading buffer, and run at 25 V/cm, 4-10°C for 4 hours. Gels were stained with ethidium-bromide either before (0,5 mg/l) pouring or after run inside the refrigerator box (1 mg/l in TBE) for 15 minutes and destained in TBE for 15 minutes, both with gentle agitation. Digital photographs (2.5 sec exposures) were taken while excitation of the gel with 254 nm UV-light.</p> <p>The Quantity One (version 4.3.0) software (BIO-RAD) was used for pattern analysis.</p>
Do's, don'ts	Gel electrophoresis should be performed under refrigeration (4-10 °C).
References	<p>Olive, D.M.; Bean, P. 1999. Principles and applications of methods for DNA-based typing of microbial organisms. J. Clin. Microbiol. 37: 1661-1669.</p> <p>Rademaker, J.L.W.; Louws, F.J.; de Bruijn, F.J. 1998. Characterization of the diversity of ecologically important microbes by rep-PCR genomic fingerprinting. Molecular Microbial Ecology Manual 3.4.3: 1-27.</p> <p>Versalovic, J.; Schneider, M.; de Bruijn, F.J.; Lupski, J.R. 1994. Genomic fingerprinting of bacteria using repetitive sequence-based polymerase chain reaction. Meth. Mol. Cell. Biol. 5: 25-40.</p> <p>Ködöböcz, L.; Pacsuta, P.; Halbritter, A.; Antonyuk, L.; Biró, B. 2005. BOX-PCR characterisation of <i>Rhizobium</i> populations in agricultural lands (in Russian). In: Konnova et al. (eds.) Molekularnie Mechanizmi vzaimodejstvia mikroorganizmov i rastenij: Fundamentalnie i prikladnie aspekti, Szaratov, pp. 81-84.</p>
Links	www.taki.iif.hu/soilbiol.html
Additional information	<p>The method was used to study the diversity of <i>Rhizobium loti</i> populations as a consequence of different (conventional and alternative) agricultural practices.</p> <p>The research and the instrumental background of the PCR-Lab. were supported by the Hung. National Res. Fund (OTKA), under the contracts of M0 36959 and the T0 46610).</p> <p>Additional information could be provided from the authors</p>

ID	43_Peter_a
Author	Peter, Martina; Kohler, Annegret; Duplessis, Sébastien; Martin, Francis* UMR INRA-UHP "Interactions Arbres/Micro-Organismes" INRA-Nancy, 54280 Champenoux (France) *corresponding author: fmartin@nancy.inra.fr, ++33 383 39 40 80
Parameter	Ectomycorrhizal DNA and RNA
Plant species	Ectomycorrhizas of <i>Laccaria bicolor</i> / Douglas fir
System	Microcosms under sterile or greenhouse conditions, field
Method	Sampling of ectomycorrhizas, DNA / RNA preparations, and genotyping
Method description	<p>This protocol was used for Douglas fir seedlings that were inoculated with two different genotypes of the ectomycorrhizal basidiomycete <i>Laccaria bicolor</i>. Different fingerprinting methods and polymorphic DNA regions can be used for genotyping of extracted DNA depending on the fungal species composition.</p> <p>Washed root systems were placed in a petri dish containing water and examined using a binocular. Each ectomycorrhizal root tip was separately sampled, sectioned into a small part of around 1mm and a large part containing the tip. The small parts were separately stored in 96 micro plates for DNA analyses, whereas the larger parts were transferred into separate tubes of 8 x 0.2ml strips, immediately frozen in liquid nitrogen, and stored at – 80°C until RNA extraction. If clusters of mycorrhizas were present, parts of maximum five mycorrhizas were pooled for DNA/RNA extractions assuming that they were formed by the same strain. Depending on how many different fungal genotypes were used to inoculate plants in microcosms (or are expected to be present for field samples), a different number of root tips have to be processed. For two inoculated fungal genotypes, we have sampled 150 ectomycorrhizas to obtain enough root tips (around 50) per genotype for subsequent RNA extraction.</p> <p>DNA was extracted using the DNeasy 96 Plant kit (Qiagen, Valencia, USA) according to the manufacturer's instruction. For genotyping, the intergenic spacer region (IGS1) of the nuclear ribosomal DNA was PCR amplified using the primers 5' IGSLb (5'-GGCCATTGCGGAGAACATGAC-3') and 5SA (Henrion <i>et al.</i> 1992). These primers allowed to specifically amplify homo- and heteroduplicates of distinct sizes for the two inoculated genotypes of <i>Laccaria bicolor</i>. Primer 5'IGSLb was marked with the fluorescent dye HEX (Invitrogen, France) for fragment length detection by an ABI 310 automated genetic analyzer (Applied Biosystems, Foster City, CA, USA) using the GeneScan and Genotyper software (Applied Biosystems).</p> <p>After identification of the genotypes, larger parts of the corresponding ectomycorrhizal root tips were pooled per genotype for RNA extraction (see 43_Peter_b).</p>
References	Henrion, B.; Le Tacon, F.; Martin, F. 1992. Rapid identification of genetic variation of ectomycorrhizal fungi by amplification ribosomal RNA genes. <i>New Phytologist</i> 122: 289-298.

ID	43_Peter_b
Author	Peter, Martina; Kohler, Annegret; Duplessis, Sébastien; Martin, Francis* UMR INRA-UHP "Interactions Arbres/Micro-Organismes" INRA-Nancy, 54280 Champenoux (France) *corresponding author: fmartin@nancy.inra.fr, ++33 383 39 40 80
Parameter	Ectomycorrhizal RNA
Plant species	Ectomycorrhizas of <i>Laccaria bicolor</i> / Douglas fir, <i>L. bicolor</i> / Poplar, <i>Pisolithus microcarpus</i> / Poplar, <i>P. microcarpus</i> / <i>Eucalyptus globulus</i>
System	Microcosms under sterile or greenhouse conditions, and in the field
Method	RNA extraction from ectomycorrhizas
Method description	<p>Extraction protocol depending on host plant and system used:</p> <ul style="list-style-type: none"> • <i>Eucalyptus mycorrhizas</i> (sterile culture in petri dishes): Protocol of Logemann (1987). • <i>Poplar mycorrhizas</i> (in sterile erlenmeyer flasks): RNA extraction using the RNeasy Plant Mini Kit of Qiagen following the manufacturer's instructions. DNase treatment included. • <i>Douglas fir mycorrhizas</i> (in microcosms in the greenhouse): Modified RNA extraction protocol of Chang <i>et al.</i> (1993): <p>Components:</p> <ul style="list-style-type: none"> • Extraction buffer CTAB: <ul style="list-style-type: none"> 2% Hexadecyltrimethylammoniumbromide (CTAB) 2% Polyvinylpyrrolidone (PVP, soluble) 100mM Tris-HCl pH 8.0 25mM EDTA pH 8.0 2M NaCl 0,5 g/L spermidine beta-Mercaptoethanol 2% v/v freshly added • Chloroform • Ethanol 70% & 95% (stored at 4°C) • Lithium chloride (LiCl) 10 M • Polyvinylpolypyrrolidone (PVPP, insoluble) <p>All solutions are prepared with ultrapure water (Millipore) treated with Diethyl Pyrocarbonate (DEPC; to inhibit RNases), and are autoclaved.</p> <p>Protocol:</p> <ol style="list-style-type: none"> 1) Add 2% (v/v) of β-mercaptoethanol in CTAB-buffer. Heat to 65°C 2) Grind 100 mg of frozen material (liquid nitrogen) to a powder without defreezing. Add a few mg of PVPP (tip of spatula) and grind again. Transfer powder to 2 ml tube. 3) Add 1 ml of CTAB (65°C), vortex 30 sec-1 min, and incubate at 65°C for 10 min. 4) Vortex 10 sec, add 350 μl Chloroform, vortex 10sec, centrifuge at 13000 rpm for 15 min at 4°C 5) Transfer the upper, aqueous phase in a new 2 ml tube, repeat step 4) without initial vortexing.

	<p>6) Transfer upper, aqueous phase in a new 1.5 ml tube. Add 1/4 volume of LiCl 10M. Vortex 10 sec and place tubes at 4°C overnight (maximum 16 h).</p> <p>7) Centrifuge at maximal speed (≥ 13000rpm) for 30 min at 4°C.</p> <p>8) Discard supernatant. Wash pellets in 500 μl Ethanol 70%. Centrifuge at 13000 rpm for 12 min at 4°C.</p> <p>9) Wash pellet in 500 μl Ethanol 95%. Centrifuge at 13000 rpm for 12 min at 4°C.</p> <p>10) Discard supernatant and dry pellets at room temperature. Resuspend in 50-100 μl DEPC-H₂O.</p> <p>11) Subsequent purification and Dnase treatment using the Rneasy Plant Mini Kit (Qiagen) following the RNeasy Mini Protocol for RNA Cleanup including the Dnase treatment. DNase: RNase free DNase Set (Qiagen).</p>
References	<p>Chang, S.; Puryear, J.; Cairney, J. 1993. A simple method for isolating RNA from pine trees. <i>Plant Molecular Biology Reporter</i> 11: 113-116.</p> <p>Logemann, J.; Schell, J.; Willmitzer, L. 1987. Improved method for the isolation of RNA from plant tissues. <i>Analytical Biochemistry</i> 163: 16-20.</p>

ID	43_Prosser_a
Author	Prosser, Jim; Nicol, Graeme; Mahmood, Shahid; Freitag, Thomas School of Biological Sciences, University of Aberdeen, Cruickshank Building, St Machar Drive, Aberdeen, Scotland, AB24 3UU, UK. j.prosser@abdn.ac.uk; ++44 1224 273254
Parameter	Microbial community analysis
Soil type	Any
System	Any
Method	Microbial community analysis by denaturing gradient gel electrophoresis (DGGE)
Method description	<p><i>Background</i> DGGE is a method for separating mixed PCR amplification products of the same length but differing in primary sequence. The method involves electrophoresis of amplified gene fragments in a gradient of a denaturant (typically formamide and urea). DGGE is analogous to temperature gradient gel electrophoresis (TGGE) which uses temperature instead of chemical denaturants.</p> <p><i>Sample preparation</i> Cells are lysed in approx. 1-g-soil samples and DNA and/or RNA are extracted and purified using established methods.</p> <p><i>Amplification</i> Gene fragments are generated from target DNA by PCR amplification with primer sets specific for particular target groups. Target genes are typically 16S or 18S rRNA genes providing information on phylogenetic diversity, or functional genes specific for groups involved in particular processes (e.g. <i>amoA</i>, <i>mrcA</i>).</p> <p>Comparing DNA- and RNA-based profiles may indicate which members of a community have greater growth rate or metabolic activity. Amplification of rRNA is achieved using reverse transcription (RT) PCR, in which extracted rRNA is used to generate cDNA for subsequent PCR amplification.</p> <p>The addition of a 'GC-clamp' to one end of the PCR product increases the sensitivity of the technique. The clamp is incorporated at one end of the PCR product by including a GC-rich sequence (typically ~40 bp in length) at the 5' end of one primer. This prevents the DNA fragment from fully melting and halting migration through the gel.</p> <p><i>DGGE analysis</i> As PCR products migrate through the denaturant gradient, helical DNA fragments are partially melted in discrete domains, decreasing the mobility. Different sequences will contain domains that melt at different temperatures and are subsequently separated. The addition of a GC-clamp increases sensitivity, allowing resolution of sequences differing by only one base pair. DGGE bands are typically visualised using ethidium bromide, Sybr Green/Gold or silver staining. DGGE gels can also be probed to target specific groups within the community being profiled. Profiles are analysed visually or using gel image analysis software for comparison of presence/absence of bands or relative intensities of bands in different lanes. In addition, bands of interest may be excised and sequenced.</p>

Do's, don'ts, potential limitations, untested possibilities	<p><i>Limitations</i></p> <p>Although fragment lengths of >1500 bp can be analysed by DGGE, the method is most efficient with smaller fragments, e.g. 100 – 300 bp, allowing differences of 1 bp to be resolved. However, this reduces the phylogenetic information that can be gained by sequencing DGGE bands. A combination of DGGE profiling and cloning and screening larger PCR fragments is an indirect method of increasing the amount of phylogenetic information gained by DGGE analysis alone.</p> <p>After careful excision and reamplification of individual bands from DGGE gels, mixed sequences may be recovered. PCR products must be re-analysed by DGGE to check for purity prior to sequencing.</p> <p>Relative intensity of bands provides a measure of relative abundance but provides no information on absolute abundance.</p> <p>DGGE provides relatively rapid analysis of amplification products but lacks the resolving power of cloning and sequencing approaches.</p> <p>Degeneracies in primers can result in the presence of more than one band from one sequence. Bands with different sequences can also theoretically migrate to the same position in a gel.</p>
References	<p><i>Original application of DGGE to microbial community analysis</i> Muyzer, G.; de Waal E.C.; Uitterlinden, A.G. 1993. Appl Environ. Microbiol. 59 : 695-700.</p> <p><i>Review of DGGE applications in microbial ecology</i> Muyzer, G. 1999. Curr. Op. Microbiol. 2 : 317-322.</p> <p><i>Comparison of DNA- and RNA-based DGGE analysis</i> Felske, A.; Akkermans, A.D.L. 1998. Microbial Ecol. 36: 31-36.</p> <p><i>Example of combined cloning and DGGE approach</i> Freitag, T. E.; Prosser, J.I. 2003. Appl. Environ. Microbiol. 69: 1359–1371.</p> <p><i>Example of combined DGGE and probing approach</i> Stephen, J.R.; Kowalchuk, G.A.; Bruns, M.-A.V.; McCaig, A.E.; Phillips, C.J.; Embley, T.M.; Prosser, J.I. 1998. Appl Environ. Microbiol. 64 : 2958-2965.</p>
Links	<p>http://www.sfam.org.uk/pdf/features/dgge.pdf</p> <p>http://www.nioo.knaw.nl/CL/ME/protocol_DGGE.pdf</p>

ID	43_Prosser_b
Author	Prosser, Jim; Freitag, Thomas; Rangel-Castro, Ignacio; Mahmood, Shahid; Nicol, Graeme; Killham, Ken School of Biological Sciences, University of Aberdeen, Cruickshank Building, St Machar Drive, Aberdeen, Scotland, AB24 3UU, UK. j.prosser@abdn.ac.uk; ++44 1224 273254
Parameter	¹³C-labelled DNA
Soil type	Any
System	Liquid batch culture, soil slurries, soil microcosms and field soils
Method	Stable isotope probing of microbial communities
Method description	<p><i>Background</i> Stable isotope probing has been developed to determine which members of microbial communities actively assimilate specific compounds or groups of compounds labelled with a stable isotope. The technique can be used to study assimilation of compounds containing any stable isotope, but current applications are restricted to ¹³C-labelled compounds, which will be described here.</p> <p><i>Incubation</i> Stable isotope probing involves incubation of a laboratory culture, a soil microcosm or a field site after or during addition of a ¹³C-labelled substrate. Substrates have included methane, readily utilisable organic compounds and xenobiotics. In addition, ¹³C-CO₂ has been applied to study growth of autotrophic bacteria and assimilation of plant root exudates by rhizosphere microorganisms. Utilisation of labelled plant root exudates has been studied in microcosms and also in the field, using a specially designed mobile supply unit delivering ¹³C-CO₂ to chambers placed over vegetation.</p> <p><i>Extraction and separation of labelled PLFA and nucleic acids</i> After or during treatment, soil is sampled for extraction of PLFA, DNA or RNA. Extracted PLFA are analysed by transmethylation to fatty acid methyl esters. Concentrations are determined by GC-flame ionization detection and δ¹³C values by GC-IRMS (gas chromatography isotope ratio mass spectrometry). PLFA are then identified by comparison of retention times with reference compounds and by mass spectral analysis.</p> <p>Extracted DNA is analysed after separation of ¹²C- and ¹³C-DNA by isopycnic caesium chloride density gradient centrifugation for 16-24 h, following calibration to determine regions of ¹²C- and ¹³C-DNA). Samples can be removed from two regions with least or highest ¹³C-incorporation. However, it is highly recommended that samples are removed from fractions taken along the ¹²C-¹³C-DNA gradient. DNA from each fraction is then subjected to molecular analysis, typically amplification of 16S rRNA genes or functional genes with subsequent analysis by cloning and sequencing or by fingerprinting techniques.</p>
Do's, don'ts, potential limitations, untested possibilities	Extracted RNA is analysed following separation of ¹² C- and ¹³ C-RNA by isopycnic density gradient centrifugation in CsTFA (caesium trifluoroacetate) for 40 h. RNA from ¹² C- and ¹³ C-RNA fractions is then subjected to molecular analysis, typically RT-PCR amplification of 16S rRNA genes but it is also possible to amplify 18S from samples coming from rhizosphere soil samples. Amplification products are analysed as for DNA.

	<p><i>Limitations</i> Distinguishing incorporation of substrates by primary utilisers from that by secondary utilisers, assimilating degradation or excretion products of primary utilisers, depends on turnover time of the labelled substrates and discrimination at fast turnover times may not be possible. The sensitivity of the technique is limited to the detection of approximately 10^6 cells g^{-1} soil of fully labelled <i>Pseudomonas fluorescens</i> for RNA analysis. Depending on assimilation/degradation pathway, substrates that are only partially labelled will most likely yield only partially labelled DNA/RNA and discrimination of low label atom percentage DNA/RNA from unlabelled nucleic acids is highly error prone. Separation of ^{12}C- and ^{13}C-RNA becomes more difficult as community complexity increases.</p> <p><i>Methodological issues</i> ^{12}C-^{13}C-labelled nucleic fractions are sampled from density gradients by removing material using a syringe and needle from the bottom of centrifuge tubes, with positive pressure applied through replacement at the top of the tube with water. Detectable nucleic acid background in high density fractions can result from overloading density gradients with high concentrations of DNA/RNA, producing insufficient separation of labelled and unlabelled nucleic acids and/or GC-fractionation, or the presence of high proportions of GC-rich genomes, and may wrongly be interpreted as label incorporation. Distribution of ^{12}C- and ^{13}C-nucleic acids should be calibrated by ethidium bromide fluorescence with nucleic acids of specific label atom percentage, by measurement of buoyant density of density gradient fractions, by mass spectral analysis of $^{12/13}C$ nucleic acid ratios or by inclusion of ^{14}C-labelled tracer substrate during incubation. Time course studies are advisable to track changes in incorporation through different members of the community, potentially distinguishing between primary and secondary utilisers.</p> <p><i>Future potential</i> Determination of incorporation compounds labelled with ^{15}N and stable isotopes of other elements. Metagenomic analysis of ^{13}C-labelled DNA.</p>
References	<p><i>PLFA-based analysis</i> Boschker, H.T.S.; Nold, S.C.; Wellsbury, P.; Bos, D.; deGraaf W.; Pel, R.; Parkes, R.J.; Cappenberg, T.E. 1998. Nature 392: 801-804.</p> <p><i>DNA-SIP</i> Radajewski, S.; Ineson, P.; Parekh, N.R.; Murrell, J.C. 2000. Nature 403: 646-649.</p> <p><i>RNA-SIP, fractionation and quantitative analysis</i> Lueders, T. ; Manefield, M. ; Friedrich, M.W. 2004a. Environ. Microbiol. 6 : 73-78. Lueders, T. ; Wagner, B. ; Claus, P. ; Friedrich, M.W. 2004b. Environ. Microbiol. 6 : 60-72. Manefield, M.; Whiteley, A.S.; Griffiths, R.I.; Bailey, M.J. 2002. Appl. Environ. Microbiol. 68: 5367-5373</p> <p><i>Analysis of root exudate utilisation in the field</i> Ostle, N. ; Ineson, P. ; Benham, D. ; Sleep, D. 2000. Rapid Commun. Mass Sp. 14 : 1345-1350. Rangel-Castro, J.I.; Kilham, K.; Ostle, N.; Nicol, G.W.; Anderson, I.C.; Scrimgeour, C.M.; Ineson, P.; Meharg, A.; Prosser, J.I. 2005. Environ. Microbiol. 7: 828-838.</p>

ID	43_Rosling_a
Author	Rosling, Anna; Ihrmark, Katarina Department of Forest Mycology and Pathology, SLU, Box 7026, 750 07 Uppsala, Sweden; Anna.Rosling@mykopat.slu.se; Katarina.Ihrmark@mykopat.slu.se; ++46 18 – 67 18 73
Parameter	Identification of ectomycorrhizal symbionts from individual root tips
Soil type	Organic and mineral soil
Plant species	Ectomycorrhizal root tips from forest trees
System	field or microcosm
Method	Part 1: DNA extraction
Method description	<p>DNA extraction from individual ectomycorrhizal root tips is a prerequisite for further molecular identification of the fungal symbiont. This chapter describes the protocol used in our lab. Variations of the protocol are used in other groups.</p> <p><i>DNA extraction</i> Individual living root tips are separated from the soil and placed in micro centrifuge tubes. If not immediately processed the samples can be stored frozen (–20°C).</p> <ol style="list-style-type: none"> 1. Homogenize the root tip in 50 µl of 2% CTAB using a micro pestle. 2. Add 550 µl of 2% CTAB and heat at 65°C for at least 40 minutes. 3. Centrifuge for 5 min at 13 000 rpm. 4. Transfer the supernatant to a new tube by pipetting. 5. Add an equal volume (ca 250-500 µl) of chloroform to the tube. 6. Mix gently and centrifuge for 10 minutes at 10 000 rpm. 7. Transfer the upper phase to a new tube and precipitate the DNA by adding 1.5 volumes of cold isopropanol (2-propanol). Mix. 8. Centrifuge for 30 minutes at 13 000 rpm. 9. Remove the supernatant by pouring or pipetting of the liquid. 10. Add 600 µl cold 70% ethanol. 11. Mix gently and centrifuged for 5 minutes at 13 000 rpm. 12. Slowly remove the supernatant and air-dry the pellet at room temperature. 13. Resuspend the pellet in 50µl of TE buffer or milli-Q water. <p><i>Recipes for CTAB & TE</i></p> <p>2% CTAB 10 ml 0.2 g CTAB (hexadecyltrimethylammonium bromid) 5.78 ml milli-Q H₂O Dissolve the CTAB in water by heating. 1.0 ml 1 M Tris-HCl (pH 8) 2.8 ml 5 M NaCl 0.4 ml 0.5 M EDTA (pH 8)</p> <p>TE buffer 100 ml 1.0 ml 1 M Tris-HCl (pH 8) 0.2 ml 0.5 M EDTA (pH 8) 98.8 ml milli-Q H₂O</p>

Do's, don'ts, potential limitations, untested possibilities	<p><i>General suggestions</i></p> <ul style="list-style-type: none"> • Start with 10 – 24 samples if it is the first time that you extract DNA. As you become more experienced you can expect to extract 72 samples simultaneously. • Always extract an even number of samples, this way you don't have to worry about balancing the centrifuge. • Set the temperature of the heat block before you start the homogenisation. • Don't forget to have cold isopropanol and 70% ethanol ready in the freezer. • The quantity and quality of DNA extract can be examined by gel electrophoresis. If you have unbroken DNA you will see a large band / blob at the top of the lane. If the DNA has been degraded a lot during the process you will see a smear throughout the lane. Degraded DNA is not a big problem for further PCR amplification of the ITS region since this region is present in many copies. <p><i>Specific suggestions</i></p> <p>Step 2: Longer heating up to 10 – 12 h does not affect the extraction negatively.</p> <p>Step 4: The extracted DNA is in the supernatant. Avoid getting any debris from the pellet into the separated supernatant. The debris can be frozen and kept as a backup of the sample.</p> <p>Step 6: Do not centrifuge faster since this may cause the chloroform to penetrate the tube wall.</p> <p>Step 7: If you need a pause in the process this is a good place to stop. After adding the cold isopropanol the samples can be stored to the next day in the freezer. Gently mix the content of the tubes before proceeding with step 8.</p> <p>Step 8: Organize the tubes so that you know where the almost invisible pellet will be located after centrifugation.</p> <p>Step 9: Obvious pellets are rarely seen in these extractions. There is not a lot of material but do not despair it will be enough for PCR amplification. Pipet at the surface and follow the surface as it goes down. Avoid touching the tube-wall where the pellet is expected to be.</p> <p>Step 12: See above (Step 9). After removing nearly all the supernatant you can either place the tubes upside down on a klenex or leave them open in their rack to air-dry.</p> <p>Step 13: Add the 10% TE buffer and let the tubes sit over night in the fridge. If you are in a hurry you can accelerate the re-suspension by pipetting up and down in the tube for a few minutes.</p>
References	<p><i>DNA is extracted according to (excluding the initial freeze-thawing step):</i> Gardes, M.; Bruns, T.D. 1993. ITS primers with enhanced specificity for basidiomycetes--application to the identification of mycorrhizae and rusts. <i>Molecular Ecology</i> 2: 113-118.</p>
Links	<p>www links/databases/detailed protocols</p>

ID	43_Rosling_b
Author	Rosling, Anna; Ihrmark, Katarina Department of Forest Mycology and Pathology, SLU, Box 7026, 750 07 Uppsala, Sweden; Anna.Rosling@mykopat.slu.se; Katarina.Ihrmark@mykopat.slu.se; ++46 18 – 67 18 73
Parameter	Identification of ectomycorrhizal symbionts from individual root tips
Soil type	Organic and mineral soil
Plant	Ectomycorrhizal root tips from forest trees
System	Field or microcosm
Method	Part 2: PCR-RFLP
Method description	<p>PCR-RFLP is widely used to group and identify the fungal symbiont from individual ectomycorrhizal root tips. This chapter describes the protocol used in our lab. Variations of the protocol are used in other groups.</p> <p><i>Polymerase Chain Reaction - PCR amplification</i> The ITS region of the rDNA is amplified by PCR (Mullis and Faloona, 1987) following a modified protocol by Henrion et al. (1994).</p> <ol style="list-style-type: none"> 1. Use the primer pair (forward + reverse) that gives the best result. Choose from the universal primers ITS1 (forward), ITS4 (reverse) (White et al., 1990) or the fungal specific primer ITS1f (forward) and the basidiomycete specific primer ITS4b (reverse) (Gardes and Bruns, 1993). see links below for more primers. 2. PCR is performed in 50 µl and the final concentrations of the reaction mixture are the following: 200 µM of all four nucleotides, 0.3 µM of each primer, 3.1 mM MgCl₂ and 0.0375 units/µl of DNA polymerase (Expand™ High Fidelity PCR System, Roche, Basel, Switzerland). 3. Optimal DNA template concentrations are established individually for each sample by testing amplification success using dilution series. DNA template was added as 25% of the final reaction volume. 4. The PCR program started with denaturation at 94°C for 3 minutes, followed by 35 cycles of 94°C for 30s, 50°C for 45s and 72°C for 60s. 5. The quantity and quality of PCR products are examined by agarose gel electrophoresis (Gardes & Bruns, 1993) and visualised by ethidium bromide staining and UV light, using a GelDoc™ 2000 Gel Documentation Systems and Quantity One v.4.1.0 software (Bio-Rad Laboratories, Hercules, California). <p><i>Restriction fragment length polymorphism, RFLP</i> Restriction fragment analysis can be performed on samples from which a pure and strong DNA fragment has been amplified by PCR. Restriction enzymes cut the DNA string at a specific base pair combination resulting in fragments with a sequence specific length. Cutting with the three enzymes: <i>Hinf</i> I, <i>Mbo</i> I and <i>Taq</i> I (Promega), gives satisfactory resolution between different mycorrhizal species.</p> <ol style="list-style-type: none"> 1. Restriction enzymes are delivered with an optimal buffer and instructions for incubation temperature. The PCR products are cut with each restriction enzyme in a separate micro tube, 5 µl PCR product with 2 units enzyme in a total reaction volume of 10 µl. After mixing enzyme, PCR product and buffer the tubes are placed in a water bath or heating block at appropriate temperatures for 2 hours. 2. Gel electrophoresis as above except that a 2.3% agarose gel (Metaphor agarose, FMC Bio Products) is used. Images of the RFLP patterns are saved in TIFF format and analysed by Taxotron (RestrictoScan® 1994, RestrictoTyper®1996, Adanson600 1994 and Dendrograf® 1994) from The Pasteur Institute, Paris, France. Fragment patterns are compared to a ref. library (Kårén et al., 1997).
Do's, don'ts, potential limitations, untested possibilities	<p><i>Suggestions for the PCR</i> Always include a negative control (sterile water) and a positive control (known DNA template) in each PCR run. The negative control is to make sure that you are not amplifying a contamination and the positive control is to make sure that everything is right with your Master Mix and the PCR protocol, in case you don't get any PCR</p>

products from your samples.

Step 2: While testing different protocols for optimal amplification it is advisable to run the PCR in 10 µl to save money. Prepare the PCR reaction by making a Master Mix containing dNTP, primers, buffer, MgCl₂ and enzyme (keep on ice). Make enough Master Mix for all samples you are planning to run plus at least 10% extra (to cover for pipetting errors). Pipet Master Mix into all PCR tubes and then add DNA template to each tube separately. Example of Master Mix for 24x10 µl reactions.

Component (conc.)	In one tube (µl)	In x27 Master Mix (µl)
Water	4.175	113
Buffer (x10 with MgCl ₂)	1	27
MgCl ₂ (25mM)	0.65	17.6
dNTP (2mM)	1	27
Primer 1 (10µl)	0.3	8.1
Primer 2 (10µl)	0.3	8.1
Enzyme	0.075	2
Total	7.5	202.8

Step 3: Making dilution series and testing is an option to measuring the DNA concentration of the template. Most samples work without diluting the template. If not, dilution series may cover the range of 1:2 – 1:10 000 but for DNA extractions from mycorrhizal root tips the most commonly used dilutions are 1:2, 1:10, 1:100 and 1:1000. Dilutions may very well be necessary even if you never even saw a pellet during the extraction.

Step 5: Using 5 µl of the PCR reaction is usually enough to see the PCR reaction on the gel. Include a size marker on the gel.

Double bands after PCR amplification

Amplification of double bands occur in 5-25% of all PCR amplifications of the ITS region from mycorrhizal root tips. This may be a result of simultaneous colonisation of the root tip by more than one fungus (Rosling *et al.*, 2003). Separating the PCR products either by gel separation and reamplification or by PCR cloning can identify the different fungal partners. These two options are briefly discussed below.

Gel separation: Double-banded PCR products are separated on a 1% agarose gel at 3 V/cm for 3 –4 hours. (Long and slow separation results in pure bands). PCR bands are visual under UV light but long exposure may result in degradation of the PCR products. To avoid this first cut out the individual lanes in the gel. The separated bands in the lane are then cut out by taking gel plugs from the bands using a Pasteur pipette. (Prepare sterile Pasteur pipettes with a cotton "air-filter" and tubes with warm sterile water. The rubber bulb is useful both when lifting the gel plug out of the band and when flushing it into a tube. It is easier to get the gel plug out of the pipette by having warm water in the tubes.) The PCR product is dissolved from the plugs in 200 µl of deionised water overnight. Separated bands are reamplified using the same PCR procedure as used in the initial amplification, using the water with PCR product as template. The concentration of PCR product may vary greatly between different separations and it may be necessary to test different dilutions. If reamplification with the initial primers is not successful you may try nesting one of the primers.

PCR cloning: In most laboratories you can easily clone PCR products using a commercial cloning kit such as TOPO-TA (Invitrogen, San Diego, California). We have successfully separated double PCR products using this kit and even if it is more expensive it is also more effective than gel separation, especially if the fragments are very close in size. Picking eight clones has been enough to obtain both fragments separately.

Analysing RFLP patterns

RFLP patterns are defined by the size of the bands resulting from cutting with certain restriction enzymes. Size is measured as number of base pairs by comparing to base pair size standards. Run several lanes with standards on the gel with RFLP samples (for example one standard between every eight samples). Migration may be uneven across the gel and this can be compensated for in later analysis only if you have enough standards.

There are a number of commercial and non-commercial programs available to quantify band sizes. Taxotron is a program package that can define lanes and bands, calculate band sizes from a standard and calculate homology between different

	<p>samples based on several different enzyme cut patterns. It is not a particularly user-friendly program but it does work. Quantity One from Bio-Rad can define lanes and bands and calculate band sizes from a standard. This is easier than in Taxotron but Quantity One cannot be used for calculating homology using several enzymes. Once groups are identified based on their RFLP pattern, one sample from the group can be sequenced to identify the fungal species.</p>
References	<p><i>The type reference on PCR:</i> Mullis, K.B.; Faloona, F.A. 1987. Specific synthesis of DNA in vitro via a polymerase-catalysed chain reaction. <i>Methods in Enzymology</i> 155: 335-350.</p> <p><i>The development of the most commonly used primers for PCR of the fungal ITS region:</i> Gardes, M.; Bruns, T.D. 1993. ITS primers with enhanced specificity for basidiomycetes-application to the identification of mycorrhizae and rusts. <i>Molecular Ecology</i> 2: 113-118.</p> <p><i>More info on fungal ITS primers:</i> Henrion, B.; Chevalier, G.; Martin, F. 1994. Typing truffle species by PCR amplification of ribosomal DNA spacers. <i>Mycological Research</i> 98: 37-43.</p> <p><i>The protocol on which our procedure is based:</i> White, T.J.; Bruns, T.; Lee, S.; Taylor, J. 1990. Amplification and direct sequencing of fungal ribosomal RNA genes for phylogenetics. <i>PCR Protocols: A guide to Method and Applications</i>: 315-322.</p> <p><i>The construction of a RFLP database is described in the article:</i> Kårén, O.; Högberg, N.; Dahlberg, A.; Jonsson, L.; Nylund, J.-E. 1997. Inter- and intraspecific variation in the ITS region of rDNA of ectomycorrhizal fungi in Fennoscandia as detected by endonuclease analysis. <i>New Phytologist</i> 136: 313-325.</p> <p><i>This article briefly discuss the occurrence of double PCR bands after amplification of the rDNA ITS region from DNA extracts of ectomycorrhizal root tips:</i> Rosling, A.; Landeweert, R.; Lindahl, B.D.; Larsson, K.-H.; Kuyper, T.W.; Taylor, A.F.S.; Finlay, R.D. 2003. Vertical distribution of ectomycorrhizal fungi in a podzol profile. <i>New Phytologist</i> 159: 775-783.</p>
Links	<p><i>The home page of Tom Bruns lab contains primer maps for the ITS region:</i> http://plantbio.berkeley.edu/~bruns/</p> <p><i>More primer information can be found on the home page of Vilgalys group.</i> http://www.biology.duke.edu/fungi/mycolab/default.htm</p> <p><i>Home page of The Pasteur Institute, Paris has information on the program Taxotron:</i> http://www.pasteur.fr</p>

ID	43_Rosling_c
Author	Rosling, Anna; Ihrmark, Katarina Department of Forest Mycology and Pathology, SLU, Box 7026, 750 07 Uppsala, Sweden; Anna.Rosling@mykopat.slu.se; Katarina.Ihrmark@mykopat.slu.se; ++46 18 – 67 18 73
Parameter	Identification of ectomycorrhizal symbionts from individual root tips
Soil type	Organic and mineral soil
Plant species	Ectomycorrhizal root tips from forest trees
System	Field or microcosm
Method	Part 3. Sequencing of the rDNA ITS region
Method description	<p>Sequencing is widely used to identify the fungal symbiont from individual ectomycorrhizal root tips. Species identification is possible by comparing the sequence of individual samples to those in public databases. This chapter describes the protocol used in our lab. Variations of the protocol are used in other groups.</p> <ol style="list-style-type: none"> 1. Sequence reactions are run with only one primer in each PCR reaction and are performed on pure PCR products. PCR products are purified using the QIAquick PCR Purification Kit (QIAGEN, Hilden, Germany). The amplified ITS region is separately sequenced with both the primers that had previously produced the best PCR product. For samples with problematic sequence products, additional sequencing can be performed using internal primers ITS2 and/or ITS3 (White <i>et al.</i>, 1990). 2. Sequence reactions are performed in 10 µl reaction volume, using 2 µl TRRM (ABI PRISM™ BigDye™ Terminator Cycle Seq Kit, Applied Biosystems, Foster City, California) and 1 µl 5x sequencing buffer. With final primer concentration of 0.32 µM and purified PCR product making up 30% of the final sequence reaction volume. 3. The sequencing program performs 25 cycles of 96°C for 10s, 50°C for 5s and 60°C for 4 minutes. 4. Purify the sequence products by ethanol precipitation. Resuspend the pellet in 25 µl TSR (Template Suppression Reagent) by heating at 96°C for 2 minutes. Immediately place on ice and keep cold until ready to place in the machine. 5. Sequences are analysed using an ABI PRISM™ 310 Genetic Analyzer (Applied Biosystems, Foster City, CA, USA). The electrophoretograms of single stranded sequences are visually examined and pair wise aligned using Sequence Navigator™ v.1.0.1. (Applied Biosystems Foster City, CA, USA), in order to obtain one consensus sequence for each sample. 6. There are various analytical tools available on Internet (some useful links are listed below). To determine the degree of homology between different samples sequences can be aligned using ClustalW at EMBL (Thompson <i>et al.</i>, 1994). The identity of samples can be by found by comparing the obtained sequences with sequences in the GenBank database at NCBI using the BLAST program (Altschul <i>et al.</i>, 1997).
Do's, don'ts, potential limitations, untested possibilities	If species identity cannot be obtained using ITS sequencing additional sequencing of the first 400 bases of the large subunit may identify the fungi to the genus or family level.

	<p><i>Specific suggestions</i></p> <p>Step 1: The PCR product can also be purified by ethanol precipitation similar to the last steps of DNA extractions. This is a cheaper option that doesn't require a kit.</p> <p>Step 2: To save money the sequence reaction volume can be decreased from the 20 µl in the manufacturer's instructions to 10 µl. Make a Master Mix for all samples - one for each primer.</p> <p>Step 4: Pipette the TSR slowly because of its high viscosity.</p>
References	<p><i>PCR protocols and primer information:</i> White, T.J.; Bruns, T.; Lee, S.; Taylor, J. 1990. Amplification and direct sequencing of fungal ribosomal RNA genes for phylogenetics. PCR Protocols: A guide to Method and Applications: 315-322.</p> <p><i>On sequencing of the large subunit:</i> Hopple, J.S.; Vilgalys, R. 1999. Phylogenetic relationships in the mushroom genus <i>Coprinus</i> and dark-spored allies based on sequence data from the nuclear gene coding for the large ribosomal subunit RNA: Divergent domains, outgroups, and monophyly. Molecular Phylogenetics and Evolution 13: 1-19.</p> <p><i>The type reference for BLAST:</i> Altschul, S.F.; Madden, T.L.; Schaffer, A.A.; Zhang, J.; Zhang, Z., Miller, W.; Lipman, D.J. 1997. Gapped BLAST and PSI-BLAST: a new generation of protein database search programs. Nucleic Acids Research 25: 3389-402.</p> <p><i>The type reference for CLUSTAL W:</i> Thompson, J.D.; Higgins, D.G.; Gibson, T.J. 1994. CLUSTAL W: improving the sensitivity of progressive multiple sequence alignment through sequence weighting, position-specific gap penalties and weight matrix choice. Nucleic Acids Research 22: 4673-4680.</p>
Links	<p><i>EMBL</i> http://www.ebi.ac.uk/services/index.html</p> <p><i>GenBank</i> http://www.ncbi.nlm.nih.gov/</p>

ID	43_Santos
Author	Santos, J.C. ^{1,2)} ; Finlay, R.D. ²⁾ ; Tehler, A. ¹⁾ ¹⁾ Department of Cryptogamic Botany, Swedish Museum of Natural History, PO Box 50007, SE-104 05 Stockholm, Sweden ²⁾ Department of Forest Mycology and Pathology, SLU, PO Box 7026, SE-750 07 Uppsala, Sweden Juan.Santos@nrm.se; ++46 8 51954162
Parameter	Arbuscular mycorrhizal fungi colonising plant roots
Soil type	Sandy loam
Plant species	<i>Achillea millefolium</i> , <i>Festuca pratensis</i>
System	Field grassland system
Method	Arbuscular mycorrhizal fungal community analysis by denaturing gradient gel electrophoresis (DGGE)
Method description	<p><i>Background</i> DGGE was originally developed to detect single mutations but soon became a powerful tool in environmental microbiology. It has mostly been applied to profile bacterial and protozoan communities, but lately it has also been applied successfully in soil fungal communities.</p> <p><i>Sample preparation</i> Roots were kept frozen in their soil cores. DNA was extracted using a DNeasy Plant Kit (Quiagen). About 0.1 g of rinsed roots was placed in a 2 ml propylene tube half filled with 2.5 mm zirconia-silica beads (Biospec Products Inc) and 700 µl AP1 buffer from the kit. The tubes were shaken at 6500 rpm, 30 s in a Mini-BeadBeater™ to homogenise the roots.</p> <p><i>Amplification</i> A 550 bp fragment of the 18S rRNA gene was amplified with a PCR amplification kit (puREtaq™ Ready-To-Go™, Amersham Biosciences) using the primers AM1 and NS31-GC. A mix of 2 µl of extracted DNA, 1 µl of each primer and 21 µl water were used in each reaction. The thermocycling program used was the following: 94° C for 2 min; 35 cycles of 92° C 30 s, 60° C 60 s, 72° C 45 s (with an extension of 1 s per cycle); and 72° C for 5 min.</p> <p><i>DGGE analysis</i> The PCR products were analyzed using DGGE with a DCODE Universal Mutation Detection System (Biorad). The gels were cast with a manual gradient former (Model 475, Biorad) with the following characteristics: 6% (wt : vol) polyacrylamide (37.5:1 acrylamide-bis-acrylamide), 1 mm thick and 16 x 16 cm. A linear gradient of 25 to 40% denaturant was used, where 100% denaturant acrylamide is defined as containing 7 M urea and 40% formamide. Before polymerisation, a 10-ml top gel with no denaturants was added. Electrophoresis was run in 0.5 x TAE buffer (40mM Tris-acetate, 1mM EDTA) for 16 h at 65V and 60°C. Gels were stained in MilliQ water containing 0.5 mg/l ethidium bromide for 10 minutes and destained in MilliQ water for another 10 minutes before UV transillumination.</p> <p><i>Recovery of DNA after DGGE</i> DGGE bands were excised from the acrylamide gel and put in 2 ml vials with approximately 0.5 ml of 2.5 mm zirconia-silica beads (Biospec Products Inc) and 250 µl sterile MilliQ water. In order to disrupt the gel pieces, vials were shaken with a Mini-BeadBeater™ at 5500 rpm for 20 s, kept on ice for one</p>

	<p>minute and then shaken again in the same way. The supernatant was then centrifuged shortly at low speed to pellet the acrylamide. A volume of 2 μl of supernatant was used for a further PCR amplification using the same primers and cycling as above. Representative bands were run again in a new DGGE to confirm band migration.</p>
Do's, don'ts, potential limitations, untested possibilities	<ul style="list-style-type: none"> • DGGE is a sensitive and powerful technique, but it also involves many critical steps. It requires time to set it up, certain experience and very thorough way of working in order to achieve repeatability and gel resolution. • Very similar sequences can have the same melting profile and thus appear unresolved in the gel. • Once the method has been optimized and band positions related to particular sequences, it can be applied in large number of samples to detect AMF community changes. • It is faster and cheaper, but it lacks the power resolution of cloning. Depending on the community structure, sometimes less frequent but relevant species cannot be detected. • DGGE lacks a widely accepted standard protocol because of several reasons. It is technically complicated to perform, there is a diverse range of different systems in the market and it requires careful optimization process to any particular case. This makes difficult to compare the results between different studies in comparison with e.g. cloning.
References	<p>Kowalchuk, G.A.; de Souza, F.A.; van Veen, J.A. 2002. Community analysis of arbuscular mycorrhizal fungi associated with <i>Ammophila arenaria</i> in Dutch coastal sand dunes. <i>Molecular Ecology</i> 11: 571-581.</p> <p>Öpik, M.; Moora, M., Liira, J.; Koljalg, U.; Zobel, M.; Sen, R. 2003. Divergent arbuscular mycorrhizal fungal communities colonize roots of <i>Pulsatilla</i> spp. in boreal Scots pine forestland grassland soils. <i>New Phytologist</i> 160: 581-593.</p> <p>de Souza, F.A.; Kowalchuk, G.A.; Leeflang, P., van Veen, J.A.; Smit, E. 2004. PCR-denaturing gradient gel electrophoresis profiling of inter- and intraspecies 18S rRNA gene sequence heterogeneity is an accurate and sensitive method to assess species diversity of arbuscular mycorrhizal fungi of the genus <i>Gigaspora</i>. <i>Applied and Environmental Microbiology</i> 70: 1413-1424.</p> <p>Ma, W.K.; Siciliano, S.D.; Germida, J.J. 2005. A PCR-DGGE method for detecting arbuscular mycorrhizal fungi in cultivated soils. <i>Soil Biology & Biochemistry</i> 37: 1589-1597.</p>
Links	<p><i>A very well illustrated and detailed description of how to cast gels and run electrophoresis</i> http://www.nioo.knaw.nl/CL/ME/protocol_DGGE.pdf</p>
Additional information	<p>There is a DGGE discussion group at http://groups.yahoo.com/group/dgge/ where questions about the technique can be posted.</p>

ID	43_Shinano
Author	Takuro Shinano ¹⁾ , Atsuya Sato ¹⁾ , Jun Wasaki ¹⁾ and Mitsuru Osaki ²⁾ ¹⁾ Hokkaido University, Creative Research Initiative “Sousei“, N 21, W 10, Kitaku, Sapporo, Japan ²⁾ Graduate School of Agriculture, Hokkaido University, N9 W9, Kitaku, Sapporo, Japan ++81-11-706-9210; takuro@chem.agr.hokudai.ac.jp
Parameter	DNA in soil
Soil type	Paddy soil
Plant species	Rice
System	Field soil
Method	Determination of soil DNA content
Method description	<p><i>Sample preparation</i> Soil DNA was sampled based on the method by Bürgmann et al. (2003).</p> <p><i>DNA concentration determination</i> 1) Use PicoGreen based on the manufacture’s instruction. 2) To obtain blank sample, add DNase to each sample as a blank. This is crucial to determine the correct amount of DNA concentration in soil, when the humic acid is contaminated. 3) Mix 10 µl of sample and blank solution with 200µl of RiboGreen reaction solution and 20 µl of DNase buffer. For the blank, each soil DNA solution was added with DNase. All the examined solution was put under 37C for 1 hour.</p>
Do’s, don’ts, potential limitations, untested possibilities	<ul style="list-style-type: none"> • We have only the experience on paddy soil. • Diluting the sample solution is not sufficient to determine the exact amount of DNA in the soil. • To confirm the level of DNA in the sample, we also use 0.7 % Agarose gel with 0.2 % PVPP. By using this gel and DNA standard solutions approximate amount of DNA is also evaluated.
References	<p><i>DNA purification method:</i> Bürgmann, H.; Widmer, F.; Sigler, W.V.; Zeyer, J. 2003. Appl. Environ. Microb. 69: 1928-1935.</p>

ID	43_Steinkellner
Author	Steinkellner, Siegrid; Vierheilig, Horst Institut für Pflanzenschutz (BOKU), Department für Angewandte Pflanzenwissenschaften und Pflanzenbiotechnologie Peter-Jordan-Str. 82; A-1190 Wien/Austria ++43 1 47654-3352; siegrid.steinkellner@boku.ac.at
Parameter	Microconidia germination of <i>Fusarium oxysporum</i> in root exudates
Plant species	Any plant
System	Perlite culture in growth chamber
Method	Microscopic analysis
Method description	<p><i>Plant material</i> Seeds are surface-sterilized and grown in sterilized perlite for various periods. According to their requirements the plants are watered with a nutrient solution.</p> <p><i>Extraction of root exudates</i> See 41_Vierheilig.</p> <p><i>Fungal cultures</i> <i>F. oxysporum</i> strains are grown on Czapek Dox Agar at 24 °C in darkness. Under sterile conditions fungal cultures are flooded with sterilized water and the suspension is filtered through three layers of filter paper. The spore-suspension is concentrated by centrifugation at 3000 g for 10 min and adjusted to 1.0 x 10⁷ microconidia/ml water using a haemocytometer.</p> <p><i>Germination experiments</i> The germination assay is performed in sterile culture plates (24 wells). Aliquots of 500 µl of root exudate are mixed with 100 µl of spore suspension and incubated at 24 °C in the dark while shaking with 200 rpm. Microconidia germination is determined microscopically after 24 h by counting 200 spores. Sterilized water and Czapek Dox solution are included in the germination experiments as a control. The experiments are performed in triplicates.</p>
Do's, don'ts, potential limitations, untested possibilities	<ul style="list-style-type: none"> • We have applied this method to <i>Fusarium oxysporum</i> microconidia only. However, this system will also work with other fungal propagules, such as macroconidia or chlamydospores. • The pH-value of the root exudates did not affect spore germination of <i>F. oxysporum</i> f. sp. <i>lycopersici</i>.
References	<p>Steinkellner, S.; Mhammerler, R.; Vierheilig, H. 2005. Microconidia germination of the tomato pathogen <i>Fusarium oxysporum</i> in the presence of root exudates. J. Plant Interact. 1: 23-30.</p> <p>Nelson, P.E.; Toussoun, T. A.; Marasas, W.F.O. 1983. <i>Fusarium</i> species an illustrated manual for identification. Pennsylvania State University Press, University Park, London.</p>

ID	43_Taylor
Author	Taylor, A.F.S. Department of Forest Mycology and Pathology, SLU, PO Box 7026, SE-750 07 Uppsala, Sweden; Andy.Taylor@mykopat.slu.se; ++46 18 672797
Parameter	Morphological identification of ectomycorrhiza
Soil type	Most soil types
Plant species	Predominantly Pine, Spruce and Birch but also other plant species
System	Harvested root tips
Method	Morphotyping of ectomycorrhizal roots
Method description	<p><i>1. Extracting mycorrhizal tips</i> <i>Aim: extract all live mycorrhizal tips with the minimum of disturbance</i> A) Samples should first be soaked in water for at least ½ hour. This loosens up the soil making it easier to extract the root material and reducing the amount of damage caused to the mycorrhizal tips. Gently loosening the sample manually will speed up the soaking process. B) Pour the water and sample over a set of sieves. The best size combination of sieves is one at 2 mm over one with a mesh size of 250µm. Gently rinse your sample under a stream of water. Try to remove as much soil as possible but with the minimum amount of disturbance to the root material. If there are large chunks of soil adhering to the roots, it is better to remove these from the sieve and place them in water in a large 15 cm Petri dish. Once you have removed all of the soil that you can, pick out the root fragments visible to the naked eye and place them in a large Petri d.. C) Drain the water from the sieve and then place it under a dissection microscope and systematically scan the sieve for all live root fragments. Place these in the large Petri dish with the rest of the root material.</p> <p><i>2. Morphotyping</i> <i>Aim: To group together all the morphologically similar mycorrhizal tips.</i> A) Place a large Petri dish under the dissection microscope and partly fill with water. Then take one piece of root material from the Petri dish containing all of the material from the sample. Using fine forceps remove the attached debris from the root – if there are rhizomorphs on the tips try to leave these as intact as possible. Once you have removed the soil debris, examining the mycorrhizal tips for general growth form, hydrophobicity, colour, presence / absence of rhizomorphs and extra-radical mycelium development. Separate mycorrhizal tips that you think are morphologically distinct and place them in water in a cell of the multiwell dish. B) Repeat this process until you have worked through all of the root material. C) Finally, examine the multiwell dish under the dissection microscope. Go over each well and make sure that all of the tips in one well look the same. These groups of tips now represent your <i>morphotypes</i>. Makes notes on the characters of each morphotype that you used to distinguish between them.</p> <p><i>3. Mantle preparations</i> <i>Aim: To confirm that your morphotypes are distinct and that within a morphotypes, tips share the same anatomical features.</i> A) Start with the most abundant morphotypes. Select a representative tip, remove from the well with forceps and place on a microscope slide. Only use the amount of water that came along with the tip. This will dry up fairly quickly and you should prevent this by dipping closed forceps in water and adding this water to your tip. Using a small quantity of water gives you much greater control over the tip and the pieces of mantle that you remove. B) Hold the tip at the proximal end (the end at which it was attached to the main root). First, detach any rhizomorphs attached to the tip and move them a short distance away from the tip. Next, from a region about half way along your tip, try to remove pieces of the mantle with a sharp pointed dissection needle. If you have a very fine pointed pair of forceps, you can also use a single point of the forceps to remove the mantle. This is best done by pushing the pointed tip into the root and moving the</p>

	<p>needle towards the distal end of the root. Some mantles become detached very easily, others cannot be removed without cortical cells going with them.</p> <p>C) When you have managed to get some pieces of mantle, make sure that they are lying with the outside uppermost. You will be able to tell which way is up because of the curvature of the mantle. It is also important that you also have <i>one piece</i> which is <i>upside down</i>, so that the inner surface of the mantle is uppermost.</p> <p>D) Try and remove the mantle from the extreme tip of the root. This should come off as a small cap. Make sure this is sitting with the outside uppermost.</p> <p>E) Remove the remains of the root tip. Add a small quantity of water to your mantle prep. and make sure that the mantle and rhizomorph pieces are near the centre of the drop in the correct orientation and a coverslip onto them. If you add the coverslip from one side all of the mantle pieces will end up at the end of your coverslip.</p> <p>F) Examine your preparation under 400x and then under 1000x. Determine the nature of any extraradical mycelium extending out from the mantle, including any rhizomorphs. Add these characters to the notes you made on the morphotype.</p> <p>G) Focus on the upper most layer of the mantle and determine the shape of the cells. Then focus down into the mantle and determine the shape of the cells in deeper layers. Add these characters to the notes you made on the morphotype.</p> <p>H) Make preparations for from another two tips from the same morphotype to determine if they have the same anatomy.</p> <p>I) Repeat this whole process for each morphotype</p> <p>4. Preparing tips as vouchers specimens and for molecular analysis</p> <p>A) Representative tips from each morphotype should be stored in a suitable fixative to act as voucher specimens for future reference. Many people use FAA (formaldehyde : ethanol 70% : acetic acid = 5 : 90 : 5), which can be stored at room temperature in air tight containers.</p> <p>B) If there is a sufficient number of tips within a morphotype it is a good idea to place a representative tip in each of four separate Eppendorf tubes and then have a fifth tube with five tips. Tips can be placed in either 70% ethanol or in extraction buffer (e.g. CTAB). It is also possible to place the tips directly in the Eppendorf tubes and freeze them without placing them in any liquid.</p> <p>5. Microscopic features to look for in your mantle preparation:</p> <ul style="list-style-type: none"> • Are there rhizomorphs present? <ul style="list-style-type: none"> ○ Where were the rhizomorphs attached to the tip (distally / proximally)? ○ Do the rhizomorphs have smooth or diffuse edges? ○ Are these simple with all the hyphae the same diameter? ○ Are some of the inner hyphae of a larger diameter? <ul style="list-style-type: none"> ▪ Are the septae of the enlarged hyphae dissolved or intact? • Is there hyphae emanating from the mantle? <ul style="list-style-type: none"> ○ Are there encrustations or warts on the surface? ○ Are the hyphae clamped? ○ Are there anastomoses between the emanating hyphae? <ul style="list-style-type: none"> ▪ Are these septate or open? <ul style="list-style-type: none"> • Are the septae simple or clamped? <ul style="list-style-type: none"> ○ If clamped, are they contact clamps? ○ Are the walls coloured? <ul style="list-style-type: none"> ▪ If so what colour are they? • Are there short, determinate hyphae (<i>Cystidia</i>) emanating from the mantle? <ul style="list-style-type: none"> ○ What shape are these? ○ Are these clamped at the base? • Are the cells in the surface layer of the mantle linear or cellular? • Does the mantle have the same structure all the way through?
References	<p>Agerer, R. 1986-1998. Colour Atlas of Ectomycorrhizae. Schwäbisch-Gmünd: Einhorn-Verlag.</p> <p>Agerer, R. 1991. Characterization of Ectomycorrhiza. Methods in Microbiology 23: 25 – 73.</p> <p>Agerer, R.; <i>et al.</i> 1996-2004. Descriptions of Ectomycorrhizae. Schwäbisch-Gmünd: Einhorn-Verlag.</p> <p>Chilvers, G.A. 1968. Some distinctive types of Eucalypt mycorrhizas. Australian Journal of Botany. 26: 49-70.</p> <p>Dominik, T. 1969. Key to ectotrophic mycorrhizas. Folia Forestalia Polonica Seria A Lesnictwo 15: 309-328.</p>
Links	<p>www.deemy.de. – An online handbook on the characterisation of ectomycorrhizas.</p>

ID	43_Zakhia
Author	Zakhia, F. ¹⁾ ; Domergue, O. ¹⁾ ; Cleyet-Marel, J.C. ¹⁾ ; Dreyfus, B. ¹⁾ ; de Lajudie, P. ¹⁾ ; Jeder, H. ²⁾ ; Atallah, T. ³⁾ ; Willems, A. ⁴⁾ ¹⁾ LSTM, IRD/INRA/CIRAD/AGRO-M, Baillarguet. TA 10/J. 34398 Montpellier cedex 5 France; P-De.Lajudie@mpl.ird.fr ²⁾ IRA, Nahal-Gabès, Tunisia; habib.jeder@ira.rnrt.tn ³⁾ Faculté d'Agronomie, Université Libanaise Beyrouth. Liban; theresea@lynx.net.lb ⁴⁾ LMG, Universiteit Gent, K-L. Ledeganckstraat 35, B-9000 Gand, Belgium. Anne.Willems@UGent.be
Parameter	Phylogenetic characterisation of Legume Nodulating Bacteria (LNB)
Plant species	Wild mediterranean legumes : 22 species in Tunisia and 27 in Lebanon
Method	SDS-PAGE; Amplified Ribosomal DNA Restriction Analysis and sequencing
Method description	Spontaneous leguminous plants were prospected in two Mediterranean countries: Tunisia and Lebanon (Jeder <i>et al.</i> 1996). Root nodules from 22 legume species in Tunisia and from 27 species in Lebanon were collected and submitted to bacterial isolation (LNB) acc. to Zakhia <i>et al.</i> (2004). Diversity of LNB was first assessed by comparative SDS-PAGE analysis of total cellular protein profiles using the GelCompar 4.2 software package (Doignon-Bourcier <i>et al.</i> , 1999). Phylogenetic relationships between new isolates and reference strains were estimated by performing ARDRA (Amplified Ribosomal DNA Restriction Analysis) using: <ul style="list-style-type: none"> • FGPS 1509 and FGPS 6 primers (Normand <i>et al.</i>, 1996) to amplify 16S rDNA and 7 restriction enzymes: <i>MspI</i>, <i>CfoI</i>, <i>HinfI</i>, <i>RsaI</i>, <i>NdeI</i>, <i>AluI</i>, <i>TaqI</i>. • 16S-870f and FGPL2054' primers (Normand <i>et al.</i>, 1992; Sy <i>et al.</i>, 2001) to amplify 16S-IGS region and 3 restriction enzymes: <i>MspI</i>, <i>CfoI</i>, <i>HaeIII</i>. A dendrogram based on the UPGMA clustering of Dice correlation values (S_D) of norm. and comb. patterns using GelCompar II 2.5 software package was constructed. The nearly full-length 16S rDNA sequences of representative isolates of several ARDRA groups were determined and a phylogenetic tree was constructed by the Neighbour-joining method including reference strains of known rhizobia. Bootstrap values were calculated (1000 replications). SDS-PAGE, 16S-IGS ARDRA and 16S ARDRA were used as grouping methods. They have different discriminative levels between strains and species (SDS-PAGE), species and genera (ARDRA). Results were consistent between techniques. RFLP is a rapid, easy and reproducible in time and space method to build database, allowing to group large collections of strains and to reduce the number of sequencing.
References	Zakhia, F.; Jeder, H.; Domergue, O.; Willems, A.; Cleyet-Marel, J.C.; Gillis, M.; Dreyfus, B.; de Lajudie, P. 2004. Characterisation of wild legume nodulating bacteria (LNB) in the infra-arid zone of Tunisia System. <i>Appl. Microbiol.</i> 27:380-395. Jeder, H. et al. 1996. <i>Revue des Régions arides</i> 9: 3-10. Doignon-Bourcier, F.; Sy, A.; Willems, A.; Torck, U.; Dreyfus, B.; Gillis, M.; de Lajudie, P. 1999. Diversity of bradyrhizobia from 27 tropical Leguminosae species native of Senegal System. <i>Appl. Microbiol.</i> 22:647-661. Normand, P.; Cournoyer, B.; Simonet, P.; Nazaret, S. 1992. Analysis of ribosomal-RNA operon in the actinomycete <i>Frankia</i> . <i>Gene</i> 111: 119-124. Normand, P. et al. 1996. ITS analysis of procaryotes. In: van Elsas; De Bruijn (eds.) <i>Molec. Microbiol. Manual</i> , Akkermans, Kluwer, Dordrecht, The Netherlands, pp. 1-12. Sy, A.; et al. 2001. Methylophilic <i>Methylobacterium</i> bacteria nodulate and fix nitrogen in symbiosis with legumes. <i>J. Bacteriol.</i> 183:214-220.

ID	44_Berge
Author	Berge O.; Balesdent, J.; Haichar, F. Z.; Marol, C.; Achouak, W. CEA, DSV, DEVM, LEMIRE, Laboratoire d'Ecologie Microbienne de la Rhizosphère et d'Environnements extrêmes, UMR 6191 CNRS-CEA Aix Marseille-Univ, Cadarache, F-13108 Saint-Paul-Lez-Durance, France. odile.berge@cea.fr; ++33 442 257 863
Parameter	Root exudate-consuming microbial community structure
Soil type	Any
Plant species	Any
System	Laboratory microcosm
Method	DNA Stable Isotope probing
Method description	Plantlets are grown in soil in fully automated chambers under $^{13}\text{CO}_2$ for the labelling of rhizodeposit-consuming microbial communities. Total DNA is extracted from rhizosphere soil and fractionated in CsCl gradient by ultra centrifugation. Gradient fractions are analysed for both their DNA concentration using Picogreen dye and their ^{13}C content by GC-C-IRMS (Gas-Chromatography-Combustion-Isotope Ratio Mass Spectrometry). Bacterial community structures from ^{12}C - and ^{13}C -DNA enriched fractions are characterized by fingerprinting method (e.g., RISA, DGGE) and compared one to each other. Cloning and sequencing specific DGGE bands of the patterns identify active bacterial populations.
Do's, don'ts, potential limitations, untested possibilities	<ul style="list-style-type: none"> • Labelled vs. non-labelled microbial DNA ratio must be high enough to allow an efficient ^{13}C to ^{12}C DNA separation in the gradient. The ^{13}C isotopic abundance of labelled rhizodeposits as well, must be high enough (> ca. 50%) to provide sufficient difference in buoyant density of DNAs. • The ^{13}C cost prohibits application to mature plants. • Untested: Pulse labelling
References	<p><i>First description of the DNA-SIP method</i> Radajewski, S.; Ineson, P.; Parekh, N.R.; Murrell, J.C. 2000. Stable-isotope probing as a tool in microbial ecology. <i>Nature</i> 403: 646-649.</p> <p><i>Improvement of the technique and description of RNA-SIP</i> Lueders, T.; Manefield, M.; Friedrich, M.W. 2004. Stable isotope probing of rRNA and DNA reveals a dynamic methylotroph community and trophic interactions with fungi and protozoa in oxic rice field soil. <i>Environ. Microbiol.</i> 6: 60-72.</p> <p><i>DNA-SIP used to follow, for the first time, macromolecule degradation in soil (^{13}C content of the gradient fractions was checked).</i> Haichar, F.Z.; Achouak, W.; Heulin, T.; Marol, C.; Marais, M.F.; Mougel, C.; Ranjard, L.; Balesdent, J.; Berge, O. Identification of cellulolytic bacteria in soil by Stable Isotope Probing (SIP), <i>Submitted</i></p>

ID	44_Karlsson
Author	Karlsson, M. Dept. Evolutionary Biology, Uppsala University, Norbyvägen 18D, SE-752 36, Uppsala, Sweden ++46 18 4712640; Magnus.Karlsson@ebc.uu.se
Parameter	Amounts of nucleic acids in environmental samples
Soil type	Any
Plant species	Any
System	Field soils/roots, greenhouse studies, various microcosm
Method	Realtime quantitative PCR
Method description	<p>Realtime quantitative PCR is a convenient way of determining relative or absolute amounts of specific DNA or RNA (cDNA) in a biological sample. It is commonly used for gene expression measurements and for measuring the contribution of one organism in mixed samples.</p> <p>Nucleic acids are extracted to high purity. RNA samples should be treated with DNase to remove any residual DNA contaminants, remember to check integrity of RNA by electrophoresis under denaturing conditions. Determining nucleic acid concentrations is an important step and sensitive methods e.g. using fluorescence in replicates, are to be preferred. An internal control, e.g. synthetic mRNA, can be added to RNA samples prior to reverse transcription to control the efficiency of this reaction. The PCR primers used should be specific for the amplicon of choice, which should be short (80-200 bp) to ensure high efficiency of amplification. PCR amplification of target DNA is monitored in triplicates throughout the reaction by measuring the excitation of a fluorescent dye. Either the dye simply binds to dsDNA or alternatively, is linked to a DNA probe that anneals between the PCR primers. The 5'-exonuclease activity of Taq polymerases subsequently releases the dye. A third variant is based on hybridisation of two labelled, closely positioned probes. A melting curve analysis should be performed after the PCR reaction to ensure that the signal was the result of single product amplification. Besides the amplicon of choice, amplification of the internal control should be performed to ensure equal efficiency of reverse transcription in different samples. For relative gene expression measurements, amplification of a stably expressed reference gene should be performed in parallel. Absolute measurements can be deduced from parallel amplification of individual standard curves for each amplicon, based on serial dilutions of plasmids or PCR products. Standard curves should be included in each individual run (i.e. every 96-well plate).</p>
Do's, don'ts, potential limitations, untested possibilities	<ul style="list-style-type: none"> • Various contaminants in nucleic acid samples can effect the concentration measurements and the efficiency of subsequent enzymatic reactions. Take care when performing nucleic acid measurements, use fluorescence and replicates. Use an internal control to control efficiency of reverse transcription. • Good primer design is very important. Make sure that amplification is specific, resulting in only one amplification product. Amplicons that cover introns can be used as a control of contaminating genomic DNA (gDNA) in RNA samples, as different sized fragments will be produced from gDNA as compared to cDNA. Problems with coamplification products are common when targeting members of large gene families or from samples

	<p>containing several organisms. To increase specificity, primers can be located in non-coding regions, e.g. introns (gDNA) or 5'/3'-untranslated regions (cDNA).</p> <ul style="list-style-type: none"> • Quantitative PCR is sensitive and good laboratory practices are important, avoid pipetting small volumes and make triplicates of PCR reactions. • The choice of reference gene should be done with care, as many housekeeping genes have been reported to show considerable variation in expression. Some kind of test is necessary to ensure constitutive expression during the conditions in question.
References	<p><i>Methodology</i></p> <p>Pfaffl, M.W. 2001. Nucleic Acid Res. 29(9): 2001-2007.</p> <p>Vandesompele, J. et al. 2002. Genome Biol. 3(7): research0034.1-0034.11</p> <p>Bustin, S.A. 2000. J. Mol. Endocrin. 25: 169-193.</p> <p>Livak, K.J.; Schmittgen, T.D. 2001. Methods 25: 402-408.</p> <p>Arya, M.; Shergill, I.S.; Williamson, M.; Gommersall, L.; Arya, N.; Patel, H.R.H. 2005. Expert Rev. Mol. Diagn. 5(2): 209-219.</p> <p><i>Applications</i></p> <p>Karlsson, M.; Stenlid, J.; Olson, A. 2005. Physiol. Mol. Plant Pathol. 66: 99-107.</p> <p>Guy, R.A.; Payment, P.; Krull, U.J.; Horgen, P.A. 2003. Appl. Environ. Microbiol. 69(9): 5178-5185</p>

ID	44_Martin_Laurent
Author	Martin-Laurent, F. UMR Microbiology and Geochemistry, INRA/U. of Burgundy. 21065 Dijon Cedex France fmartin@epoisses.inra.fr; ++33 3 8069 3406
Parameter	Quantification of microbial gene expression by RT-quantitative PCR
System	Microbial culture
Method	RT-quantitative PCR
Method description	Monitoring of the expression of selected microbial genes in response to different stresses. This method allows the rapid and reliable quantification of the expression of several genes, focusing a specific microbial activity (catabolism of xenobiotics,...). Total mRNA are reverse transcribed using specific reverse primer. The cDNA target is then amplified by quantitative PCR using specific primer pairs in presence of SYBR Green. Positive controls consisting of several dilutions of standards are also amplified to check for quantitative PCR efficiency. Negative control consisting of quantitative PCR conducted directly on total RNA are also realised to check for any DNA contaminations. The determination of the cycle threshold (Ct) allowed the determination of mRNA copy number using the calibration curve reporting the mRNA copy number as a function of the Ct.
Do's, don'ts, potential limitations, untested possibilities	<ul style="list-style-type: none"> • The RT-quantitative PCR allows the quantification of the level of expression of gene in less than 45 min. The impact of different stresses on gene expression can easily be compared. • This technique allows the quantification of lowly expressed gene since up to 1 copy can be detected by quantitative PCR from a complex cDNA template. In addition, the expression of genes belonging to multifamily can be differentiated by using TaqMan® RT-quantitative PCR based on the use of specific probe labelled with fluorescent quencher and reporter.
References	Devers, M.; Soulas, G.; Martin-Laurent, F. 2004. Real time reverse transcription PCR analysis of gene expression of atrazine catabolism genes in two bacterial strains. J. Microb. Methods 56: 3-15.
Additional information	A more detailed protocol for use of this approach is available upon request from the author.

ID	44_Peter
Author	Peter, Martina; Kohler, Annegret; Duplessis, Sébastien; Martin, Francis* UMR INRA-UHP "Interactions Arbres/Micro-Organismes" INRA-Nancy, 54280 Champenoux (France) *corresponding author: fmartin@nancy.inra.fr, ++33 383 39 40 80
Parameter	Large scale analysis of gene expression in ectomycorrhizas
Plant species	Ectomycorrhizas of <i>Laccaria bicolor</i> / Douglas fir, <i>L. bicolor</i> / Poplar, <i>Pisolithus microcarpus</i> / Poplar, <i>P. microcarpus</i> / <i>Eucalyptus globulus</i>
System	Ectomycorrhizal systems in microcosms under sterile or greenhouse conditions, and in the field
Method	cDNA array analyses of gene expression
Method description	<p><i>Sample preparation</i></p> <p>a) Producing and sampling of ectomycorrhizas (ECM): different ECM systems were used to study the gene expression in symbiotic tissues of either the fungal partner or the plant host (see Villeneuve <i>et al.</i> 1991; Duplessis <i>et al.</i> 2005). Root systems were cleaned under tap water and ECM roots were identified using a binocular. Single ectomycorrhizal root tips were sampled, frozen in liquid nitrogen, and stored at -80°C until RNA extraction. If several different fungal species or genotypes were inoculated on the same root system, morphological characteristics of ECM (Agerer, 1996-1999) were used to differentiate fungal partners. If not enough morphological features were present for clear distinction, a DNA fingerprinting step was performed for each ECM root tip before pooling corresponding genotypes for subsequent RNA extraction (see 43_Peter_a). Between 40-100 ECM tips were pooled for RNA extraction.</p> <p>b) Total RNA extraction: RNA was extracted using different protocols, depending on the host plant and system used (see 43_Peter_b).</p> <p><i>cDNA array construction</i></p> <p>Libraries were constructed using RNA extracted from different tissues of the fungal or plant species studied using the SMART cDNA library construction kit of Clontech. To obtain information about the function of cDNA clones that are spotted on arrays, clones were sequenced and annotated (cf. Kohler <i>et al.</i>, 2003; Peter <i>et al.</i>, 2003). PCR-amplified cDNA inserts were spotted on nylon membranes by Eurogentec (Saraing, Belgium; c.f. Duplessis <i>et al.</i>, 2005).</p> <p><i>Probe synthesis and cDNA array hybridization</i></p> <p>RNA populations were reverse transcribed, amplified, radioactively marked, and hybridized on arrays. Spot intensities were quantified and normalized as described in Duplessis <i>et al.</i> (2005).</p> <p><i>Data analysis</i></p> <p>For each condition, three independent replicates were performed. To identify differentially expressed genes, analysis of variance was performed using diverse freewares (cyber-T, GeneANOVA, GeneCluster). To identify co-regulated genes, diverse clustering tools were used (e.g., hierarchical, k-means, SOMs). For detailed description see Duplessis <i>et al.</i> (2005), and www links.</p>
Do's, don'ts, potential	<p><i>Sample preparation:</i></p> <ul style="list-style-type: none"> • Since gene expression changes in short periods of time, sample

<p>limitations, untested possibilities</p>	<p>preparations should be performed as fast as possible. If roots in field sites are sampled and have to be processed in the laboratory, the site should not be too far away.</p> <ul style="list-style-type: none"> • RNA should be treated with DNase for library construction and probe synthesis, in particular for the study of the fungal partner, since polyA rich regions in ribosomal and mitochondrial DNA are also amplified when using the polyT-primer of diverse RT-PCR kits. <p><i>cDNA array hybridization:</i></p> <ul style="list-style-type: none"> • When possible, all samples to be compared should be radioactively marked and hybridized in batch to reduce technical noise in the data. <p><i>Limitations:</i></p> <ul style="list-style-type: none"> • For each fungal species studied, expressed sequence tags (ESTs) and a separate array has to be produced due to large sequence divergence (c.f. Peter <i>et al.</i>, 2003). However, species-specific arrays can be used for population studies. • For large-scale screenings in the field, we propose to apply RT-PCR techniques using primers for marker genes identified by cDNA array analyses since they are less costly and fewer root tips are needed.
<p>References</p>	<p><i>Morphological/anatomical distinction of ectomycorrhizas:</i> Agerer, R. 1996-1999. Descriptions of Ectomycorrhizae. Einhorn Verlag, Schwäbisch Gmünd.</p> <p><i>Ectomycorrhizal systems:</i> Villeneuve, N. ; Le Tacon, F. ; Bouchard, D. 1991. Survival of inoculated <i>Laccaria bicolor</i> in competition with native ectomycorrhizal fungi and effects on the growth of outplanted Douglas-fir seedlings. <i>Plant and Soil</i> 135: 95-107.</p> <p><i>cDNA library construction, cDNA sequencing and annotation:</i> Kohler, A.; Delaruelle, C.; Martin, D.; Encelot, N.; Martin, F. 2003. The poplar root transcriptome: analysis of 6000 expressed sequence tags. <i>FEBS Letters</i> 542: 37-41.</p> <p>Peter, M.; Courty, P.-E.; Kohler, A.; Delaruelle, C.; Martin, D.; Tagu, D.; Frey-Klett, P.; Duplessis, S.; Chalot, M.; Podila, G.; Martin, F. 2003. Analysis of expressed sequence tags from the ectomycorrhizal basidiomycetes <i>Laccaria bicolor</i> and <i>Pisolithus microcarpus</i>. <i>New Phytologist</i> 159: 117-129.</p> <p><i>cDNAarray construction and hybridization, ectomycorrhizal system:</i> Duplessis, S.; Courty, P.-E.; Tagu, D.; Martin, F. 2005 Transcript patterns associated with ectomycorrhiza development in <i>Eucalyptus globulus</i> and <i>Pisolithus microcarpus</i>. <i>New Phytologist</i> 165: 599-611.</p>
<p>Links</p>	<ul style="list-style-type: none"> • http://mycor.nancy.inra.fr/ • http://mycor.nancy.inra.fr/ectomycorrhizadb/index.html (Protocols) • http://visitor.ics.uci.edu/genex/cybert • http://ep.ebi.ac.uk/EP/EPCLUST/

ID	44_Schloter
Author	Schloter, M. GSF – Nat. Research Center for Environment and Health, Inst. for Soil Ecology; Ingolstädter Landstr. 1; 85758 Oberschleissheim; Germany ++49 89 31872304; schloter@gsf.de
Parameter	In situ measurements of microbial functions
System	Microcosm system
Method	Combination of microautoradiography and FISH
Method description	<p>Depending on the microbial turnover rates of the substance specific activities between 10 mCi/mmol and 200 mCi/mmol are required. For chemicals with faster turnover rates lower radioactivity can be used. The radioactive label should include those parts of the molecule which are heavily degradable.</p> <p>The incubation of the radioactive chemical in the soil should be performed in a microcosms system, which contains a device for measuring ¹⁴C-CO₂ as a measure for mineralization. Depending on the mineralization rates the soil should be incubated between 1 and 30 days with the substance. The water content of the soil should be about 70 % of the maximal water holding capacity and should be constant during the time of incubation.</p> <p>At the end of the experiment 1 g of soil is suspended in 10 ml of a 0.9 % NaCl buffer containing 0,1 % chelating resins and 0,2 % polyethyleneglycol. This suspension is treated with a beatbeater for 3 minutes to separate the microbes from the soil particles. The soil will be separated by centrifugation from the extracted microbes (1000 x g for 10 minutes). The extracted microbes are washed twice in 0.9 % NaCl to remove soluble radioactive substrate and fixed using 4% paraformaldehyde for 3 h at 4 °C. To remove the fixative afterwards the samples are washed twice like described above, cyrosectioned, transferred onto poly-L-lysine-coated coverslips and dehydrated in a ethanol series (50, 80, 96%, 3 minutes each).</p> <p>To stain the microbes by oligonucleotide probes and DAPI standard protocols were applied, followed by confocal laser scanning microscopy examination. The radioactive label was detected on the same slides afterwards using a device for autoradiographic measurements (Zinnser analytics, Germany). The optimum exposure time for the samples is depending on the radioactive signal in the microbes and is in the range from hours to 14 days.</p>
Do's, don'ts	A change of the order of FISH and autoradiographic is not recommended mainly if long exposure times of the samples for the detection of the radioactive label are required.
References	<p><i>Description of the method</i> Lee, N.; Nielsen, P.; Holm, K.; Juretschko, S.; Nielsen, J.L.; Schleifer, K.H.; Wagner, M. 1999. Combination of fluorescent in situ hybridization and microautoradiography – a new tool for the structure – function analyses in microbial ecology. Appl. Environm. Microbiol. 65: 1289-1297.</p> <p><i>Description of the microcosm system</i> Suhadoc, M.; Schroll, R.; Gattinger, A.; Schloter, M.; Munch, J.C.; Lestan, D. 2004. Effects of modified Pb-, Zn- and Cd- availability on the microbial communities and the degradation of isoproturon in a heavy metal contaminated soil. Soil Biol. Biochem. 36: 1943-1954.</p> <p><i>Application of the method to soil</i> Ferreira, P.; Radl, V.; Munch, J.C.; Schloter, M. 2005. Atrazine degradation in tropical soils. Environ. Microbiol, submitted.</p>

ID	44_Vanderleyden
Author	Vanderleyden, J. Centre of Microbial and Plant Genetics, Kasteelpark Arenberg 20, B-3001 Heverlee, Belgium ++32 16 32 96 79; Jozef.Vanderleyden@agr.kuleuven.ac.be
Parameter	Quantitative differential proteome analysis
System	Laboratory test with cultivated bacteria
Method	Two dimensional difference-in-gel electrophoresis (2D-DIGE)
Method description	50 ml of a bacterial culture is used to harvest cells. After washing the cells with PBS, the pellet is dissolved in 400 µl SDS buffer or lysis buffer. The suspension is then sonicated on ice until it is clear. After centrifugation, the supernatant is aliquoted and stored at -80° C. Before use, the protein samples are cleaned (2D clean-up kit, Amersham Biosciences) and dissolved in lysis buffer. After quantification of the samples, the proteins are minimally labeled with Cy3 or Cy5 (4pmol dye/50 µg protein, 30 min on ice). A pooled internal standard is labeled with Cy2. 50 µg of two differently labeled samples and 50 µg of the pooled internal standard are mixed and used on an IPG-strip for iso-electric focusing. The strips are then put on top of the second dimension SDS-PAGE gel, and proteins are separated. The gels are scanned, using the 3 different lasers of a laser-scanner. Image analysis (detection and quantification of differences) is performed, using the deCyder software (Amersham Biosciences).
Do's, don'ts	<ul style="list-style-type: none"> • SDS buffer is not compatible with labeling. • Before labeling the proteins, make sure the sample pH is between 8 and 9.
References	<p>Tonge, R.; Shaw, J.; Middleton, B.; Rowlinson, R.; Rayner, S.; Young, J.; Pognan, F.; Hawkins, E.; Currie, I.; Davison, M. 2001. Validation and development of fluorescence two-dimensional differential gel electrophoresis proteomics technology. <i>Proteomics</i> 1: 377-396.</p> <p>Patton, W.F.; Beechem, J.M. 2002. Rainbow's end: the quest for multiplexed fluorescence quantitative analysis in proteomics. <i>Current Opinion in Chemical Biology</i> 6: 63-69.</p> <p>Alban, A.; David, S.O.; Bjorkesten, L.; Andersson, C.; Sloge, E.; Lewis, S.; Currie, I. 2003. A novel experimental design for comparative two-dimensional gel analysis: Two-dimensional difference gel electrophoresis incorporating a pooled internal standard. <i>Proteomics</i> 3: 36-44.</p>
Links	<p>www.amershambiosciences.com</p> <p>www.weihenstephan.de/blm/deg/</p>

ID	44_VanTuinen
Author	van Tuinen, D. UMR INRA 1088/CNRS 5184/U. of Burgundy. Plant-Microbe-Environment. 21065 Dijon Cedex France tuinen@epoisses.inra.fr; ++ 33 3 8069 3248
Parameter	Expression of genes, markers of a functional mycorrhizal symbiosis
Plant species	Mycorrhizal plant
Method	Reverse Northern hybridisation of cDNA arrays
Method description	Monitoring in plant roots of the expression of selected genes markers of the arbuscular mycorrhizal symbiosis. This method allows the monitoring in parallel of the expression of several selected genes, focusing a specific interaction, or development stage. The cDNA of selected cloned genes are separated by electrophoresis, and hybridised with labelled cDNA obtained from mycorrhizal and control non-mycorrhizal roots.
Do's, don'ts, potential limitations, untested possibilities	<ul style="list-style-type: none"> • The Reverse Northern approach is interesting as the level of expression of several genes can be analysed at the same time, using the same cDNA samples. Different physiological or developmental stages can be compared be easily compared. • One limiting factor is the level of expression of some genes, such can then only be detected by RT-PCR. • To increase the sensitivity of the expression detection level, radioactive labelling is recommended. • Genes from multifamily can not be differentiated by this approach
References	<p>Brechenmacher, L.; Weidmann, S.; van Tuinen, D.; Chatagnier, O.; Gianinazzi, S.; Franken, P.; Gianinazzi-Pearson, V. 2004. Expression profiling of up-regulated plant and fungal genes in early and late stages of <i>Medicago truncatula</i>/<i>Glomus mosseae</i> interactions. Description of the method, and of the marker genes. <i>Mycorrhiza</i> 14: 253-262.</p> <p>Sanchez, L.; Weidman, S.; Brechenmacher, L.; Batoux, M.; van Tuinen, D.; Lemencaeu, P.; Gianinazzi, S.; Gianinazzi-Pearson, V. 2004. Common gene expression in <i>Medicago truncatula</i> roots in response to <i>Pseudomonas fluorescens</i> colonisation, mycorrhiza development and nodulation. <i>New Phytologist</i> 161: 855-863.</p>
Additional information	A more detailed protocol for use of this approach is available upon request from the author.

ID	51_Claassen
Author	Claassen, Norbert Institute of Agricultural Chemistry, Carl-Sprengel-Weg 1, 37075 Göttingen, Germany nclaass@gwdg.de; ++49 551 395568
Parameter	Effect of complexing root exudates on transport and uptake of soil nutrients
Soil type	Any
Plant species	Any
Model type	Mechanistic model
Model description	Models have been developed in which root exudates increase the ionic nutrient concentration in solution (Nye, 1984, Kirk, 1999). In the model presented in this paper, root exudates act as a complexing agent. For this study, a mechanistic model based on nutrient sorption in the soil, nutrient transport towards the root by diffusion and massflow, and nutrient uptake was extended by the root exudation of complexing agents. The complexing agent is exuded by the root at a steady rate and its transport in soil is by diffusion and massflow. In the soil, the agent is subject to sorption and decomposition. The relation between the concentrations of a nutrient, the agent and the complex is given by an equilibrium constant. The complex is also transported by diffusion and massflow. At the root surface, the complex may either release the nutrient by desorption or be taken up completely following a Michaelis-Menten kinetic.
Limitations	Because some input data, such as diffusion coefficients for the complex, are lacking it is not yet possible to validate this model.
References	Claassen, N.; Barber, D.A. 1976. <i>Agronomy J.</i> 68: 961-964. Claassen, N.; Syring, K.-M.; Jungk, A. 1986. Verification of a mathematical-model by simulating potassium uptake from soil. <i>Plant and Soil</i> 95: 209-220. Foehse, D.; Claassen, N.; Jungk, A. 1991. Phosphorus efficiency of plants. 2. significance of root radius, root hairs and cation-anion balance for phosphorus influx in 7 plant species. <i>Plant and Soil</i> 132: 261-272. Gardner, W.K.; Barber, D.A.; Parbery, D.G. 1983. The acquisition of phosphorus by <i>Lupinus albus</i> L. 3. The probable mechanism by which P movement in the soil root interface is enhanced. <i>Plant and Soil</i> 70: 107-124. Hoffmann, C.; Ladewig, E.; Claassen, N.; Jungk, A. 1994. Phosphorus uptake of maize as affected by ammonium and nitrate-nitrogen – measurements and model calculations. <i>J. Plant Nutr. Soil Sci.</i> 157: 225-232. Kirk, G.J.D. 1999 A model of phosphate solubilization by organic anion excretion from plant roots. <i>Eur. J. Soil Sci.</i> 50: 369-378. Nye, P.H. 1983. The diffusion of two interacting solutes in soil. <i>J. Soil Sci.</i> 34: 677-691. Nye, P.H.; Marriott, F.H.C. 1969. A theoretical study of distribution of substances around roots resulting from simultaneous diffusion and mass flow. <i>Plant and Soil</i> 30: 459-472. Römheld, V. 1987. Different strategies for iron acquisition in higher plants. <i>Physiol. Plant.</i> 70: 231-234.

Application:

Model calculations were performed for P uptake from soil (buffer power 1500, soil water content 0.3 mL cm⁻³ soil, impedance factor 0.3, Michaelis constant, K_m, 200 pmol cm⁻³). The exudation rate, assumed to be for citrate, varied from low to high values as registered in the literature.

The complex consisted of 1 mol P and 4 mol citrate (Gardner et al., 1983). It was assumed to have a diffusion coefficient similar to that of phosphate (1x10⁻⁵ cm²s⁻¹), is almost not sorbed to the solid phase (buffer power = 1) and has a low stability constant of 1. Figure 1 shows the calculated P uptake of 1 cm root after 10 days. It can be seen that with no exudation, an increase of ionic P in solution from 0.2 μM to 1.0 μM also increased P uptake five-fold. As soon as a complexing agent is released P uptake decreases sharply if P is only released from the complex by desorption. On the other hand, if the root is able to absorb the complex or to break it down at the root surface (Gardner et al., 1983), uptake increased in proportion to the exudation rate. In this case, P uptake is mainly determined by the rate of exudation of the complexing agent and less by the ionic concentration of P in the original soil solution (compare both graphs of Fig. 1 when the complex is absorbed).

The data in Figure 2 help to explain these findings. Without a complexing agent, the extension of the ionic depletion zone is very narrow and the concentration gradient near the root is very steep (Figure 2a). If a complexing agent is exuded by the root, the extension of depletion is wider, but the ionic P concentration at the root surface is lower and the gradient very shallow. This is because the complexing agent picks up the P from solution and also desorbs it from the solid phase. This increases the total P in solution (see Fig. 2b, no complex uptake) and increases the potential P transport to the root, but significantly decreases ionic P near the root. Since ionic P is not replenished from the complexed P, low P uptake results. The complex distributes through the whole soil volume in the rhizosphere because of its low buffer power. If the root absorbs the whole complex, its concentration is decreased to relatively low values throughout the whole soil, also because of its low buffer power.

The model calculations show that if a chelating agent is exuded by roots, it will lead to reduced ion uptake. This is positive if the ion is toxic to the plant, such as Al or some heavy metals. If the plant is able to absorb the complex, similar to Fe siderophores, or to break it down at the root surface releasing the free ion into solution, uptake significantly increases and depends more on the rate of exudation of the complexing agent than on the ionic concentration in solution.

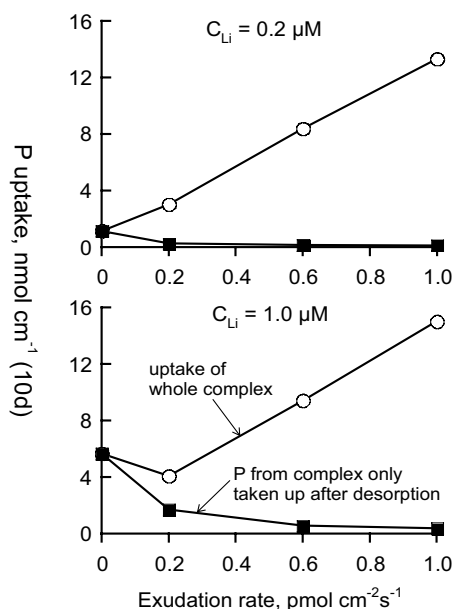

Fig. 1. Phosphorus uptake from a soil of solution concentration (C_{Li}) of 0.2 μM or 1.0 μM. P is being complexed by root exudates, like citrate, and P uptake is in ionic form from soil solution or after desorption from the complex, or the whole complex is taken up.

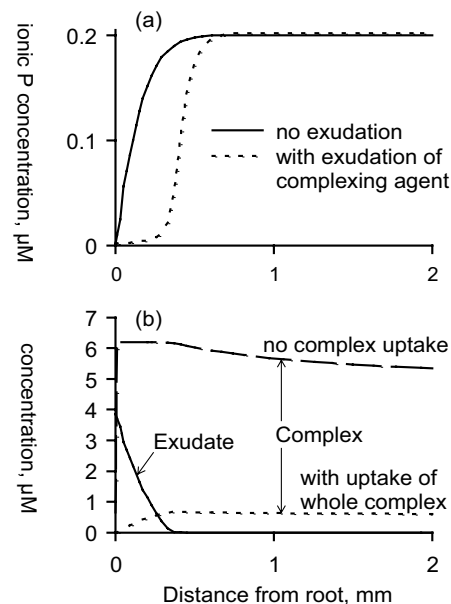

Fig. 2. Concentration profile of ionic P (a) and exudate or complex (b) after 4 days.

ID	51_DeWilligen
Authors	De Willigen, Peter ¹⁾ ; Heinen, Marius ¹⁾ ; Mollier, Alain ²⁾ ¹⁾ Alterra, PO Box 47, NL-6700 Wageningen, The Netherlands peter.dewilligen@wur.nl; Marius.Heinen@wur.nl ²⁾ UMR INRA-ENITA "Transfert sol-plante et Cycle des Eléments Minéraux dans les écosystèmes cultivés" Centre de Recherches de Bordeaux-Aquitaine, 71, Avenue Edouard-Bourleaux, B.P.81 33883 Ville nave d'Oron Cedex; mollier@bordeaux.inra.fr
Parameter	Description of rooting patterns as generated by a diffusion process
Soil type	Arable soils, artificial root media (e.g. rockwool)
Plant species	Field crops (leeks, wheat, maize, cedar), Ornamental crops (Thuja) Glasshouse crops (tomato)
System	Field soil, greenhouse
Method	Root length measurement with pinboard and numerical root distribution model
Method description	<p><i>Measurement of root distribution:</i> The distribution of roots in one or preferably in two dimensions by means of auger sampling or pinboard methods should be done possibly at two moments in time. Details of the methods can be found in Do Rosário <i>et al.</i> (2000).</p> <p><i>Fitting of parameters:</i> The observed rooting patterns are used to find estimates of the parameters characterizing the root growing process. There are generally four parameters: the diffusion coefficient of root extension in horizontal (or radial, in case of cylindrical systems) direction, likewise that in vertical direction, the relative death rate of the roots, and the production rate of the roots. In the estimation procedure a numerical model is used which calculates iteratively the root distribution until the sum of squares between calculations and observations is minimal.</p> <p>The numerical model is also part of a larger model on transport to and uptake by roots of water, nitrogen and phosphorus.</p>
Do's, don'ts, potential limitations, untested possibilities	Though the model in principle can be extended with functions which describe the reduction of e.g. the diffusion coefficients due to local environmental conditions (e.g. the moisture content), this is not worked out completely. It should at the moment be used for situations where conditions are homogeneous.
References	<p><i>Root sampling:</i> Do Rosario, M.; Oliveira, G.; Van Noordwijk, M.; Gaze, S.R.; Brouwer, G.; Bona, S.; Mosca, G.; Hairah, K. 2000. Auger sampling, ingrowth cores and pinboard methods. In: Smit, A.L.; Bengough, A.G.; Engels, C.; Van Noordwijk, M.; Pellerin, S.; Van De Geijn, S. (eds.) Root Methods, Springer, Berlin, pp. 175-210.</p> <p><i>Theory and analytical solutions:</i> De Willigen, P.; Heinen, M.; Mollier, A.; Van Noordwijk, M. 2002. Two-dimensional growth of a root system modelled as a diffusion process. I. Analytical solutions. Plant and Soil 240: 225-234.</p>

Numerical solutions:
 Heinen, M.; Mollier, A.; De Willigen, P. 2003. Growth of a root system described as diffusion. II Numerical model and application. *Plant and Soil* 252: 251-265.

Application to ornamental crops:
 Pronk, A.A.; De Willigen, P.; Heuvelink, E.; Challa, H. 2002. Development of fine and coarse roots of *Thuja occidentalis* „Brabant“ in non-irrigated and drip irrigated field plots. *Plant and Soil* 243: 161-171.

Uptake models:
 Heinen, M. 2001. FUSSIM2: Brief description of the simulation model and application to fertilization scenarios. *Agronomie* 21: 285-296

Additional information

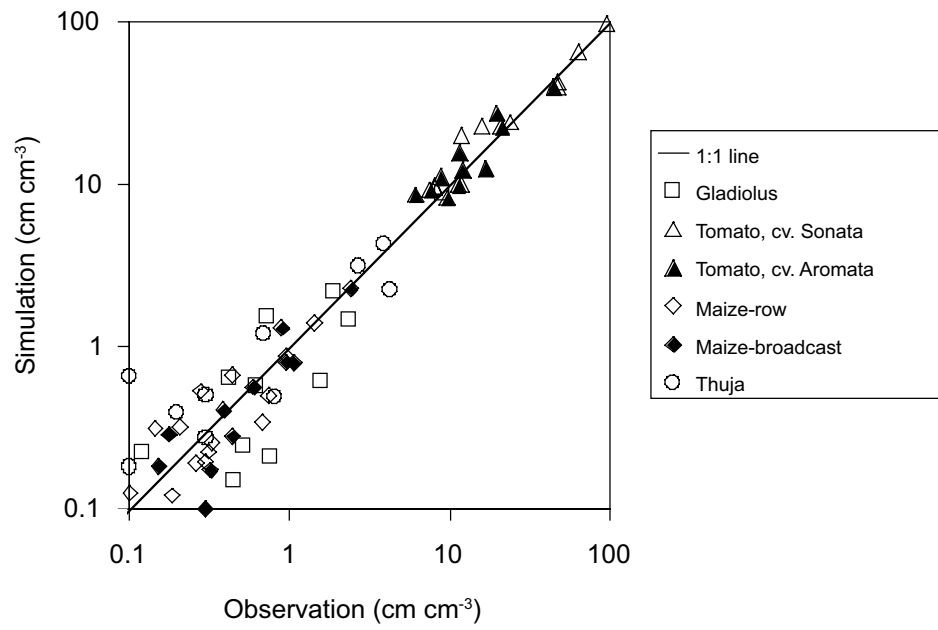

Fig. 1: Observed and simulated root length densities for different crops (from Heinen et al., 2003; with kind permission of Springer Science and Business Media).

ID	51_Doussan
Author	Doussan, Claude INRA – Unité Climat, Sol, Environnement – Domaine S ⁱ Paul – Site Agroparc – 84914 Avignon Cedex 9, France doussan@avignon.inra.fr; ++33 4 32 72 22 38
Parameter	Soil water content/gradients from the rhizosphere to root system scales; Root water uptake and flow within the root system
Soil type	Any
Plant species	Any; but species tested so far: maize, narrow leaf Lupin, peach tree
System	Single root to whole root system scales
Model type	Water uptake and transfer in the soil-root system coupled with root system architectural modelling
Model description	Soil water uptake by plant roots results from the complex interplay between plant and soil which modulates and determines transport processes at a range of spatial and temporal scales: at small scales, uptake rates are determined by local soil and root hydraulic properties but, at the plant scale, local processes interact within the root system and are integrated through the hydraulic architecture of the root system and plant transpiration. We propose a model describing both soil and plant processes involved in water uptake at the scale of the whole root system with explicit account of individual roots. This is achieved through the unifying concepts of root system architecture and hydraulic continuity between the soil and plant. The model is based on a combination of architectural, root system hydraulic and soil water transfer modelling (Figure 1).
Do's, don'ts, potential limitations, untested possibilities	<i>Output:</i> 3D water content, water potential variations with time and space in the soil; water potential and water fluxes in the root system. <i>Other possibilities:</i> It is possible to simulate only the root system architecture and growth, or only the root hydraulics, or only the soil water transfer. <i>Limitations:</i> Calculations can be lengthy and restrict simulation for a period of a few days of uptake. Growth is not taken into account on this time period. Numerous data needed to parameterize the soil and the plant characteristics.
References	Doussan, C.; Pagès, L.; Vercambre, G. 1998. Modelling of the hydraulic architecture of root systems: An integrated approach to water absorption -- 1. Model description, <i>Annals of Botany</i> 81: 213-223. Pages, L.; Vercambre, G.; Drouet, J.L.; Lecompte, F.; Collet, C.; Le Bot, J. 2004. Root Typ: a generic model to depict and analyse the root system architecture. <i>Plant and Soil</i> 258: 103-119. Doussan, C.; Pierret, A.; Garrigues, E.; Pagès, L. 2006. Water uptake by plant roots: II – Modelling of water transfer in the soil root-system with explicit account of flow within the root system – Comparison with experiments. <i>Plant and Soil</i> 283: 99-117.
Links	Check at http://www.avignon.inra.fr/internet/unites/cse/TMSH/version_index_html for updated informations

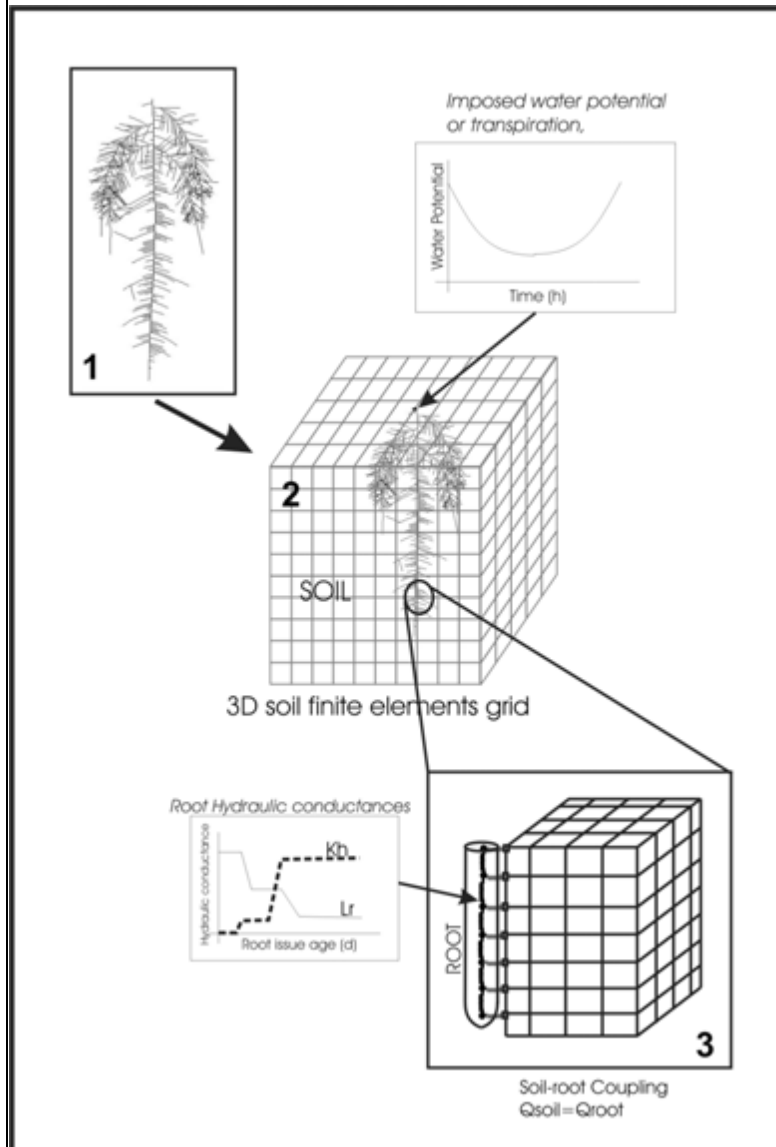
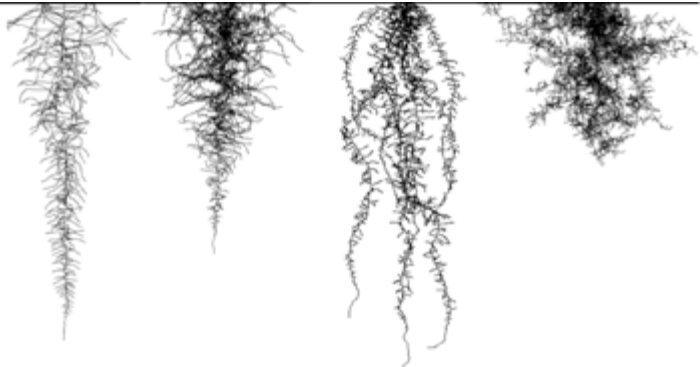

Figure 1 : Modelling sequence of the water transfer in the soil-root system. 1) A simulated root system is generated by the architecture model of the root system. 2) The calculation nodes of the simulated root system are interfaced with a finite element grid for solution of soil water transfers. 3) Calculation nodes at the interface between the root and the soil are used to set the soil water potential boundary condition for the plant and the internal sink condition for the soil. Plant and soil solutions are iterated until difference of flux entering the root/leaving the soil is less than a prescribed threshold. Plant root hydraulic conductance distribution within the root system and soil hydrodynamic characteristics are model parameters. Either xylem water potential (~ leaves water potential) at the base of the root system or plant transpiration is the 'atmospheric' boundary condition for the plant (from Doussan et al., 2006; with kind permission of Springer Science and Business Media).

ID	51_Dunbabin
Author	Dunbabin, Vanessa Tasmanian Institute of Agricultural Research, University of Tasmania, Private Bag 54, Hobart, Tasmania, 7001, Australia Vanessa.Dunbabin@utas.edu.au; ++61 3 6226 2651
Parameter	Water and solute transport to, and uptake from rhizosphere soil by plant roots
Soil type	Any
Plant species	Annual species with fibrous root systems
Model type	ROOTMAP, three dimensional root architectural model
Model description	<p>Current modelling approaches operate at distinct scales, from solute transport and uptake at the rhizosphere-scale (see 51_Schnepf and 51_Nietfeld), to water and nutrient uptake and growth at the plant and crop scales. Interaction between these scales of modelling is needed to investigate the impact of rhizosphere-scale processes on plant and crop production. The three-dimensional root architecture model ROOTMAP incorporates a rhizosphere soil volume for simulating the effect root exudates on solute transport and uptake by whole plants.</p> <p>The ROOTMAP three-dimensional root architecture model simulates soil water and nutrient dynamics, and root growth responses to these dynamics. ROOTMAP utilises a positive feedback relationship between plant demand signals for soil resources (water and nutrients), and local supply signals from each root segment, to drive the allocation of internal assimilates, affecting growth rate of root tips, root branching behaviour, and local nutrient uptake rates. Root systems therefore respond to local soil conditions, and overall growth is affected by the total uptake of soil resources. ROOTMAP can simulate any root architecture, modelling the development of root systems of individual plants, of monoculture crops, or of species mixtures with different rooting architectures and root function.</p> <p>ROOTMAP incorporates a rhizosphere soil volume that encapsulates all roots. The physical properties of the rhizosphere soil, such as soil water release and phosphate adsorption characteristics, can be changed by the release of root exudates. This in turn will affect water and nutrient transport to the rhizosphere, and plant uptake.</p> <p>Water and nutrients are transported around the bulk soil and between bulk soil and rhizosphere soil by mass flow and diffusion, as described by the advection-dispersion equation. Bulk soil values of water and solute concentration vary in time and 3D space, at a predefined grid resolution. Water and nutrient uptake is from the rhizosphere soil volume. Potential for ion uptake at the root surface is described by Michaelis-Menten kinetics. The water uptake routine is based on a Feddes sink term, and the redistribution of water in 3D space is described by Darcy's law. Van Genuchten's relationships describe soil water retention and conductivity. The Langmuir equation describes the phosphate adsorption isotherm.</p> <p>ROOTMAP can be used to investigate the interactions between root form and function, the dynamic and heterogeneous soil environment, and root exudation, and to investigate the impact of these interactions on resource foraging by root systems.</p>

Do's, don'ts, potential limitations, untested possibilities	<ul style="list-style-type: none"> • The volume of soil affected by root exudates can differ depending upon the species, the exudate, the root type, plant age and nutrition. Currently, the rhizosphere volumes in the model are of a predefined thickness that can be different for each root branching order. • Exudation can be limited to specific root types/root orders. • Initial testing work has simulated young plants with root exudates/root mucilage affecting soil properties along the root length. • This method could be developed further to simulate the effect of the decay of compounds in root mucilage on soil physical properties in the rhizosphere.
References	<p><i>Incorporating a rhizosphere volume into ROOTMAP for considering rhizosphere dynamics in whole root system modelling:</i> Dunbabin, V.M.; McDermott, S.; Bengough, A.G. 2006. Plant Soil 283: 57-72.</p> <p><i>Detailed description of the ROOTMAP model:</i> Dunbabin, V.M.; Diggle, A.J.; Rengel, Z.; van Hugten, R. 2002. Plant Soil. 239: 19-38.</p>
Links	http://www.clima.uwa.edu.au/research/pulses/rootssystem
Additional information	 <p>Fig. 1. Example of some of the root architectures that can be produced by the ROOTMAP model.</p>

ID	51_Hopmans
Author	Hopmans, Jan W. Hydrology/LAWR, University of California, Davis, CA 95616 USA jwhopmans@ucdavis.edu; ++1 530 752 3060
Parameter	Plant water and nutrient uptake in soil-root systems
Soil type	Any
Plant species	Any
Model type	Numerical modeling of root architecture coupled with unsaturated soil water flow and nutrient transport; whole plant level
Model description	<p>The importance of root function in water and nutrient transport is becoming increasingly clear, as constraints on agricultural resources are imposed due to water limitations and environmental concerns. Water and nutrient transport towards plant roots can be mechanistically formulated by a coupled dynamic approach, linking nutrient extraction to water uptake, controlled by the transient and locally-variable supply of water and nutrients to the roots. In the most general approach, the sink term S_i denoting root water uptake in the Richards' Equation for each soil compartment i of the root zone domain, can be written as</p> $S_i(t) = \alpha_i(h_m, \pi, t) RDF_i T_{pot}(t) \quad (1)$ <p>where $T_{pot}(t)$ denotes the potential plant transpiration ($L T^{-1}$) and RDF_i ($L^2 L^{-3} L^{-1}$) represents a multi-dimensional normalized root water uptake function, distributing water uptake according to the relative presence of roots. The localized stress response function $\alpha_i(h_m, \pi, t)$, accounts for the local influence of soil water osmotic (π) and matric potential (h_m) on root water uptake rate as a function of time (t), with values between zero and one (no stress). The value of $T_{pot}(t)$ is solely defined by atmospheric conditions.</p> <p>In its most general form, the three-dimensional root water uptake model can be written as</p> $RDF_i = \frac{X_m Y_m \beta_i}{\int_0^{X_m} \int_0^{Y_m} \int_0^{Z_m} \beta_i dx dy dz} \quad (2a)$ $\text{where } \beta_i = \left(1 - \frac{x_i}{X_m}\right) \left(1 - \frac{y_i}{Y_m}\right) \left(1 - \frac{z_i}{Z_m}\right) e^{-\frac{\rho_x}{X_m} x^* - x_i - \frac{\rho_y}{Y_m} y^* - y_i - \frac{\rho_z}{Z_m} z^* - z } \quad (2b)$ <p>and X_m, Y_m, and Z_m, denote maximum root exploration in directions of x, y, and z, respectively. With empirical parameters ρ_x, ρ_y, ρ_z, x^*, y^*, and z^*, this single expression was shown to simulate a wide variety of water-uptake patterns, with parameter values estimated using inverse modeling, minimizing residuals of spatially-distributed measured and simulated water content values. The coupled model by Clausnitzer and Hopmans (1994) simulates space and time dependent values of β_i, as controlled by local soil environmental conditions such as water content, temperature, and soil resistance. Similarly, a comprehensive form of $\alpha(h_m, \pi)$ can be written as</p> $\alpha(h_m, \pi) = \frac{1}{1 + \left[\frac{\chi h_m + \pi}{\pi_{50}} \right]^3} \quad (3)$ <p>Nutrient movement towards the root surface occurs by the parallel transport of convective flow and diffusion. Nutrient transport by convection describes movement by the water as it moves through the soil towards the plant roots, as computed by</p>

	<p>solution of the Richards' Equation. High water flow rates, as for example induced by irrigation, will provide increased access of dissolved nutrients to the roots, whereas small water flow velocities tend to create depletion of nutrients near the roots. Although mass flow in general is not ion specific, differences in diffusion and adsorption coefficients between ions result in differences in soil transport rate and root supply between nutrients. Since nutrient uptake rates can be ion-specific, nutrient concentrations at the soil-root interface can be either accumulating or depleting. In addition to soil transport, nutrient uptake is controlled by the spatial distribution of roots, as influenced by its architecture, morphology and presence of active sites of nutrient uptake, including root hairs.</p> <p>Macroscopic models of nutrient uptake for a whole rooting system, use a macroscopic sink term S' in the convection-dispersion equation, that predicts nutrient uptake for each soil element i, with concentration c from:</p> $S'_i = \gamma(c)RDF_i S'_{pot} \quad (4)$ <p>where S'_{pot} denotes potential plant uptake as controlled by plant nutrient demand ($M L^{-3} T^{-1}$) and can be computed from the nutrient use efficiency using known values of the biomass produced per unit nutrient taken up, and the nutrient stress factor, γ, characterizes the effect of plant nutrient stress on crop biomass production. Rather than by describing nutrient uptake by a single macroscopic mechanism, S'_i may include both passive and active pathways, acting in parallel. For example, Somma et al. (1998) described the partitioning between passive (P) and active (A) nutrient uptake, by defining total root nutrient uptake for each volume element i by</p> $S'_i = P_i + A_i, \text{ where } P_i = S_i c_i, \text{ and } A_i \text{ is computed from } A_i = \left(\frac{J_{max} c_i}{K_m + c_i} \right), \text{ where}$ <p>J_{max} ($ML^{-2}T^{-1}$) is the maximum nutrient uptake rate and K_m (ML^{-3}) the Michaelis-Menten constant.</p>
Do's, don'ts, potential limitations, untested possibilities	<ul style="list-style-type: none"> • The modeling approach applies to a single plant root system, not allowing for competition for water and nutrients between plants. • The approach does not consider mykorrhizal effects on plant uptake. • The degree of partitioning between passive and active uptake is not clear beforehand, but is expected to depend on ion and plant species, water and nutrient stress, and other factors.
References	<p>Clausnitzer, V.; Hopmans, J.W. 1994. Simultaneous modeling of transient three-dimensional root growth and soil water flow. <i>Plant Soil</i> 164: 299-314.</p> <p>Hopmans, J.W.; Bristow, K.L. 2002. Current capabilities and future needs of root water and nutrient uptake modeling. <i>Adv. Agron.</i> 77: 104-175.</p> <p>Pierret, A.; Moran, C.J.; Doussan, C. 2005. Conventional detection methodology is limiting our ability to understand the roles and functions of fine roots. <i>New Phytologist</i>: 1-14.</p> <p>Somma, F.; Clausnitzer, V.; Hopmans, J.W. 1998. Modeling of transient three-dimensional soil water and solute transport with root growth and water and nutrient uptake. <i>Plant Soil</i> 202: 281-293.</p>
Additional information	Documentation and source code for the Somma et al. (1998) model is available upon request

ID	51_Kirk
Author	Kirk, G. NSRI, Cranfield University, Silsoe MK45 4DT, UK g.kirk@cranfield.ac.uk; ++44 1585 863294
Parameter	Buffer powers and interaction coefficients for solutes that influence each others solubilities
Soil type	Any
Plant species	Any
Model type	Chemical equilibrium – transport model on the individual root level
Model description	<p>Theory for quantifying the interactions between two or more mobile solutes that influence each others solubilities. This is often more appropriate for soils than applying surface complexation models developed for individual soil constituents. The theory is explained here for a pair of solutes, but the same principles could be applied to combinations of more than two solutes. The purpose is to express the concentrations of the solutes in the whole soil in terms of their concentrations in the soil solution; thereby the interactions can be allowed for in solute transport equations, solved simultaneously. The means of measuring the corresponding buffer powers and interaction coefficients is described in the next section.</p> <p>Considering solutes X and Y, the general reaction between them in a volume of soil forming an open system is: soil-X + Y_{solution} = soil-Y + X_{solution}.</p> <p>The changes in the concentrations in solution, δX_L and δY_L, will depend on the additions or removals from the soil, δX and δY. Hence</p> $\delta X_L = (\partial X_L / \partial X)_Y \delta X + (\partial X_L / \partial Y)_X \delta Y$ $\delta Y_L = (\partial Y_L / \partial Y)_X \delta Y + (\partial Y_L / \partial X)_Y \delta X .$ <p>Let $(\partial X / \partial X_L)_Y = b_X$ and $(\partial Y / \partial Y_L)_X = b_Y$ be the soil buffer powers of X and Y (at constant Y and X, respectively), and $(\partial X_L / \partial Y_L)_X = \lambda$ and $(\partial Y_L / \partial X_L)_Y = \nu$ be the X-Y and Y-X interaction coefficients (at constant X and Y, respectively). Then substituting these in the above equations expanded using the chain rule gives:</p> $b_X (\delta X_L - \lambda \delta Y_L) = (1 - \nu \lambda) \delta X$ $b_Y (\delta Y_L - \nu \delta X_L) = (1 - \nu \lambda) \delta Y .$ <p>Hence terms in X and Y in transport equations can be expressed in terms of X_L and Y_L and the equations solved.</p>
Do's, don'ts, potential limitations, untested possibilities	<p>The buffer powers and interaction coefficients can be measured as follows. Often changes in X_L have little effect on changes in Y_L, as for example where X is soil phosphate and Y is a solubilizing acid. Then $\nu = 0$ and</p> $b_X (\delta X_L - \lambda \delta Y_L) = \delta X$ $b_Y \delta Y_L = \delta Y .$ <p>Hence at a particular constant value of X_L (i.e. $\delta X_L = 0$),</p> $(\delta X / \delta Y)_{X_L} = -\lambda b_X / b_Y .$

	Therefore λ can be found by evaluating $(\delta X/\delta Y)_{X_L}$ at the appropriate value of X_L and multiplying it by b_X/b_Y . The buffer powers are found from the appropriate adsorption or desorption isotherms. Often the buffer powers are roughly linear over the relevant concentration ranges.
References	<p><i>Original theory:</i> Nye, P.H. 1983. The diffusion of two interacting solutes in soil. J. Soil Sci. 34: 677-691. Nye, P.H. 1984. On estimating the uptake of nutrients solubilized near roots or other surfaces. J. Soil Sci. 35: 439-446.</p> <p><i>Applications:</i> Kirk, G.J.D.; Saleque, M.A. 1995. Solubilization of phosphate by rice plants growing in reduced soil: prediction of the amount solubilized and the resultant increase in uptake. Eur. J. Soil Sci. 46: 247-255. Kirk, G.J.D. 1999 A model of phosphate solubilization by organic anion excretion from plant roots. Eur. J. Soil Sci. 50: 369-378. Huguenin-Elie, O. Kirk, G.J.D.; Frossard E. 2003. Phosphorus uptake by rice from soil that is flooded, drained or flooded then drained. Eur. J. Soil Sci. 54: 77-90.</p>

ID	51_Kuzyakov
Author	Kuzyakov, Yakov Institute of Landscape Matter Dynamics, Leibniz-Centre for Agricultural Landscape Research ZALF, Eberswalder Str.84, D-15374 Müncheberg, Germany kuzyakov@zalf.de; ++49 33432 82326
Parameter	Separation of root respiration and rhizomicrobial respiration in non-sterile soil
Soil type	Not useful for alkaline soils
Plant species	Crops, grassland. Not useful for trees.
System	Microcosm, controlled conditions
Model type	Modeling of $^{14}\text{CO}_2$ efflux dynamics for separation of root and rhizomicrobial respiration
Model description	<p><i>Aim:</i> Separation of root respiration and rhizomicrobial respiration in non-sterile soil and estimation of C amount passed through both fluxes.</p> <p><i>Method:</i> Coupling of pulse labelling of plants in $^{14}\text{CO}_2$ atmosphere with modelling of below-ground C fluxes</p> <p><i>Steps:</i></p> <ol style="list-style-type: none"> 1) Plant shoots are pulse labeled in $^{14}\text{CO}_2$ atmosphere for a short period (0.5 – 5 hours) 2) The dynamics of $^{14}\text{CO}_2$ efflux from the soil (optional: and ^{14}C content in shoots, roots, microorganisms, dissolved organic carbon and soil) is measured during the first 1-2 weeks after labelling 3) Model (references below) parameters responsible for root respiration and exudation will be fitted on the experimentally measured $^{14}\text{CO}_2$ efflux from the soil 4) Both processes: root respiration and rhizomicrobial respiration are modelled separately by using fitted parameters and integrated to obtain C amounts passed through each flow. <p>The model describes well $^{14}\text{CO}_2$ efflux from the soil and ^{14}C dynamics in shoots, roots and soil, but predicts unsatisfactorily the ^{14}C content in microorganisms and DOC. The model also allows for division of the total $^{14}\text{CO}_2$ efflux from the soil in $^{14}\text{CO}_2$ derived from root respiration and $^{14}\text{CO}_2$ derived from rhizomicrobial respiration by use of exudates and root residues.</p> <p><i>Results:</i> For 43-days-old <i>Lolium perenne</i>, root respiration and rhizomicrobial respiration amounted for 7.6% and 6.0% of total assimilated C, respectively, which accounts for 56% and 44% of root-derived $^{14}\text{CO}_2$ efflux from the soil. The sensitivity analysis has shown that root respiration rate affected the curve of $^{14}\text{CO}_2$ efflux from the soil mainly during the first day after labelling. The changes in the exudation rate influenced the $^{14}\text{CO}_2$ efflux later than first 24 hours after labelling.</p>
Do's, don'ts, potential limitations	<ul style="list-style-type: none"> • Model parameterization is necessary. • Can be used only with ^{14}C or ^{13}C labeling of plants.

References

Kuzyakov, Y.; Kretschmar, A.; Stahr, K. 1999. Contribution of *Lolium perenne* rhizodeposition to carbon turnover of pasture soil. *Plant and Soil* 213: 127-136.

Kuzyakov, Y.; Ehrensberger, H.; Stahr, K. 2001. Carbon partitioning and below-ground translocation by *Lolium perenne*. *Soil Biology and Biochemistry* 33: 61-74.

Kuzyakov, Y.; Domanski, G. 2002. Model for rhizodeposition and CO₂ efflux from planted soil and its validation by ¹⁴C pulse labelling of ryegrass. *Plant and Soil* 239: 87-102.

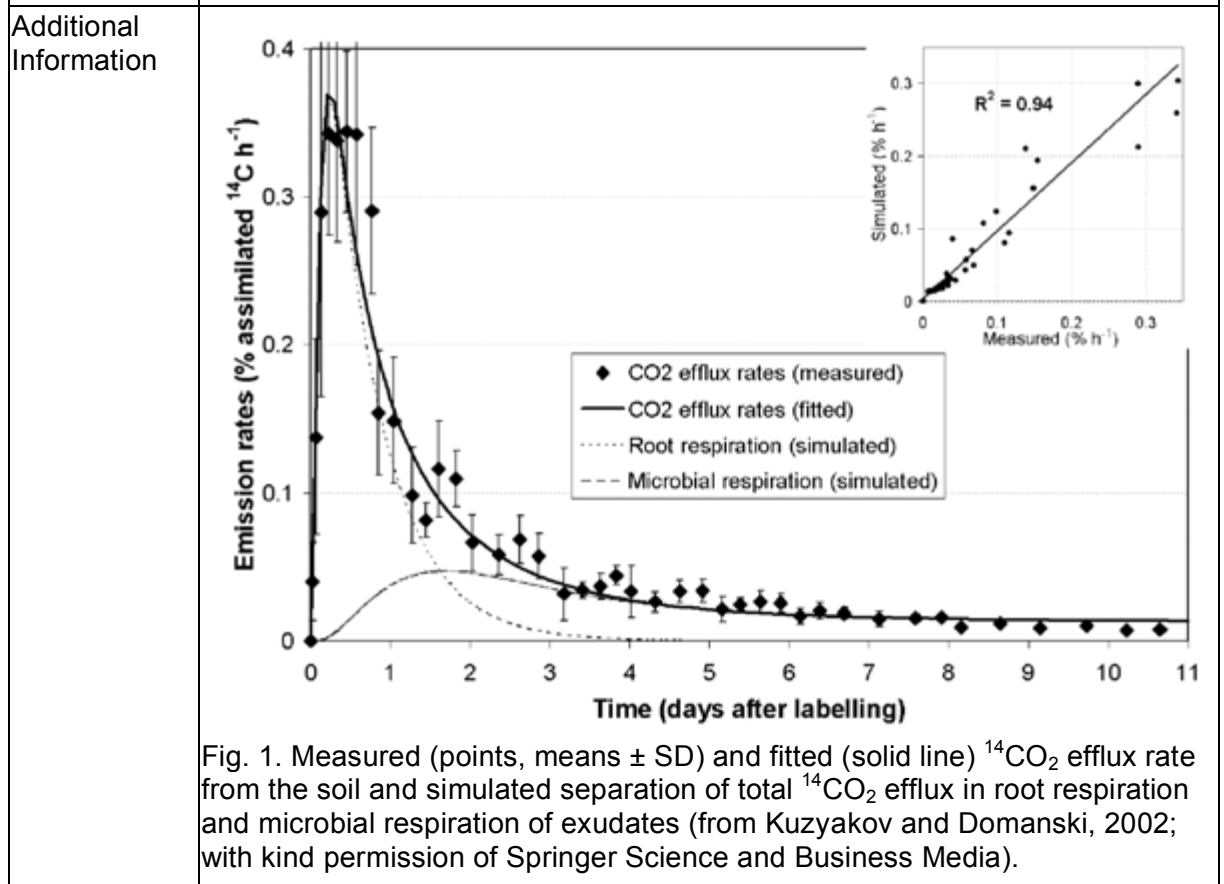

ID	51_Nietfeld
Author	Nietfeld, Heino Institute of Soil Science & Forest Nutrition, University of Göttingen Büsgenweg 2, D-37077 Göttingen, Germany hnietfe@gwdg.de; ++49-551-393518
Parameter	Modelling of ion dynamics in the rhizosphere (pre-defined set of ions)
Plant species	Any
Model type	Multispecies rhizosphere model on the single root level
Model description	<p>The multi-species model may be considered as an extension of the one-component models (see Nye and Tinker, 2000). It describes the dynamics of a predefined species set in the rhizosphere that also includes the mineral nutrients relevant for the cation-anion uptake balance.</p> <p>The transport of the ions in the rhizosphere soil is described by diffusion and a transpiration-induced daily-patterned water flux. The diffusion transport is modelled according to the Nernst-Planck equation. The Nernst-Planck equation describes the ion diffusion fluxes in electrolyte systems and considers the concentration gradient and the gradient of the diffusion potential as driving forces. The diffusion potential is essential due to the differences of the self diffusion mobilities of the ions involved. In contrast to the constant buffer power (linear adsorption isotherm) used in one-component rhizosphere models the multi-species model describes the exchange between soil solution and soil exchanger via the cation selectivity approach (Gaines-Thomas approach). The self-ionization of water, the protolysis of H₂CO₃ and the formation/dissolution of aluminium complexes (in acid soils) are included in the model. The root uptake is modelled according to the Michaelis Menton kinetics. The efflux rates of H⁺ or OH⁻ ions are calculated implicitly by means of the cation-anion imbalance of the actual root ion uptake rates. Thus, the model provides for maintenance of electro-neutrality of soil, solution and root nutrient uptake.</p>
Do's, don'ts, potential limitations, untested possibilities	<p><i>Output:</i> The model calculates simultaneously the ion-specific depletions and accumulations of nutritional ions and other ions involved in the species set, the root-induced pH changes and the actual root uptake rates of the ions involved.</p> <p><i>Other possibilities:</i> For model validation the model is available in Cartesian coordinates in order to simulate the ion dynamics in soil columns and modified root containers (operational rhizosphere)</p> <p><i>Limitations:</i> Measurements of all relevant ions in soil solution, soil exchanger and plant are needed for comparison with model results</p>
References	Nietfeld, H. 2001. Modelling of the aluminum chemistry in the rhizosphere of forest trees roots growing in acid soils. In: Gobran, G.; Wenzel, W.W.; Lombi, A. (eds.) Trace Elements in the Rhizosphere, CRC Press, Boca Raton, FL., pp. 253-308.

ID	51_Nowack
Author	Nowack, Bernd (Coordinator) EMPA – Materials Science and Technology, Lerchenfeldstrasse 5, CH-9014 St. Gallen, Switzerland; nowack@empa.ch; ++41 71 274 76 92 Authors: members of the “Modeling” Working Group 1 of COST Action 631
Parameter	Modelling rhizosphere processes
Soil type	Any
Plant species	Any
Model type	Coupled speciation-transport models
Model description	The classical model for root uptake of solutes from the soil supposes a cylindrical root surrounded by soil through which the solute diffuses and is taken up in a Michaelis-Menten process. The conventional modeling of solute uptake does not consider feedback loops between the root and the soil, e.g. root-induced chemical changes in the rhizosphere. These changes can be for example acidification or exudation of organic anions to solubilize ions. These processes change the chemical characteristics in the rhizosphere and therefore affect the uptake. We have used available coupled speciation-transport codes to include these feedback loops into solute uptake into roots. These codes are ORCHESTRA, PHREEQC, and MIN3P.
Do's, don'ts, potential limitations, untested possibilities	<ul style="list-style-type: none"> • The different approaches to implement a cylindrical root in these coupled speciation-transport codes have been validated using the analytical solution of the solute uptake by a single root as reference. • The implementation of root uptake into these three codes will be very useful for researchers working on rhizosphere-soil interactions and help to ease modeling of chemical processes in the rhizosphere. • The procedures for the different codes can be obtained from the developers (see addresses below)
Reference	Nowack, B.; Mayer, K. U.; Oswald, S. E.; Van-Beinum, W.; Appelo, C. A. J.; Jacques, D.; Seuntjens, P.; Gérard, F.; Jaillard, B.; Schnepf, A.; Roose, T. 2006. Verification and intercomparison of reactive transport codes to describe root-uptake. <i>Plant and Soil</i> 285: 305-321.
Contact details of the developers:	<p>ORCHESTRA: <i>Wendy VanBeinum</i>, Central Science Laboratory, Sand Hutton, York YO41 1LZ, UK, w.vanbeinum@csl.gov.uk</p> <p><i>Andrea Schnepf</i>, University of Natural Resources and Applied Life Sciences, BOKU, Department of Forest and Soil Sciences, A-1180 Vienna, Austria, andrea.schnepf@boku.ac.at</p> <p>PHREEQC: <i>Diederik Jacques</i>, Performance Assessment Section, Waste & Disposal Department, SCK*CEN, Boeretang 200, B-2400 Mol, Belgium; djacques@sckcen.be</p> <p><i>Piet Seuntjens</i>, Vito, Flemish Institute for Technological Research, Boeretang 200, B-2400 Mol, Belgium, piet.seuntjens@vito.be</p> <p>MIN3P: <i>Sascha Oswald</i>, Department of Hydrogeology (HDG), UFZ Centre for Environmental Research Leipzig-Halle GmbH, 04318 Leipzig, Germany; sascha.oswald@ufz.de</p> <p><i>Uli Mayer</i>, Department of Earth and Ocean Sciences, University of British Columbia, Vancouver, British Columbia V6T 1Z4, Canada, umayer@eos.ubc.ca</p>

ID	51_Roose_a
Author	Roose, Tiina Mathematical Institute, 24-29 St Giles', Oxford OX1 3LB, United Kingdom. Tel. roose@maths.ox.ac.uk; ++44 1 865 270 744
Parameter	Plant nutrient uptake, single root scale
Soil type	Any
Plant species	Any
Model type	Mathematical Modeling; Analytical approximations
Model description	<p>The classic nutrient uptake model of Barber (1995) describes the root system effectively as a single cylindrical sink with the same length and volume as the root system being simulated, but ignoring the variation in root radius, branching and three-dimensional spatial relations. The model considers the diffusion and convection of nutrients in the soil pore water and its uptake at the root surface, i.e.,</p> $(\theta + b) \frac{\partial C_L}{\partial t} - \frac{aV}{r} \frac{\partial C_L}{\partial r} = \frac{\theta D}{r} \frac{\partial}{\partial r} \left(r \frac{\partial C_L}{\partial r} \right),$ <p>where V is the water flux at the root surface, a is the root radius and therefore $u = -aV/r$ is the water flux at distance $r=a$ from the root surface, θ is the soil fluid volume fraction, b is the buffer power, and D is the diffusivity of the solute in the soil pore space.</p> <p>The flux of nutrient into the root is given by a boundary condition</p> $\theta D \frac{\partial C_L}{\partial r} - VC_L = F_{\max} \frac{C_L}{C_L + K_m} \quad \text{at } r = a$ <p>where F_{\max} and K_m are Michaelis-Menten nutrient uptake parameters. Far away from the root we can assume that the nutrient concentration is undisturbed from initial $C_L \rightarrow C_{L,0}$ as $r \rightarrow \infty$.</p> <p>Crucially, since the uptake at the root surface is given by the non-linear Michaelis-Menten uptake law, this model has in past been solved only numerically making the extension of the model for more complex root morphologies very difficult. Roose et al. (2001) show how this model can be solved analytically. However, before proceeding with solution, a lot can be learned from dimensional analysis of the model. By non-dimensionalising the model using the following scales $C_L^* = \frac{C_L}{K_m}$, $r^* = \frac{r}{a}$ and $t^* = \frac{\phi D}{(\phi + b)a^2} t$, we get the following dimensionless model, on dropping asterisks,</p> $\frac{\partial C_L}{\partial t} - Pe \frac{1}{r} \frac{\partial C_L}{\partial r} = \frac{1}{r} \frac{\partial}{\partial r} \left(r \frac{\partial C_L}{\partial r} \right)$ $\frac{\partial C_L}{\partial r} + Pe C_L = \lambda \frac{C_L}{1 + C_L} \quad \text{at } r = 1$ $C_L = C_{L\infty} \quad t > 0, r \rightarrow \infty; t = 0, 1 < r < \infty$ <p>where the dimensionless parameters are the Péclet number $Pe = \frac{aV}{\theta D}$, the uptake coefficient $\lambda = \frac{F_{\max} a}{\theta D K_m}$ and the far-field concentration $C_{L\infty} = \frac{C_{L0}}{K_m}$.</p> <p>For typical plants the Peclet number is very small and thus the dominant mechanism for nutrient movement to the root surface is diffusion. The nutrient uptake parameter λ and farfield concentration $C_{L\infty}$ can be of any size.</p>

	<p>Roose et al. (2001) solved the above equation using matched asymptotic expansions and found that the flux of nutrient into the root as a function of time is given by</p> $F(t) = \frac{2C_{L,\infty}\lambda}{1 + C_{L,\infty} + L(t) + \sqrt{4C_{L,\infty} + [1 - C_{L,\infty} + L(t)]^2}},$ <p>where $L(t) = \frac{\lambda}{2} \ln(4e^{-\gamma}t + 1)$.</p> <p>The concentration profile around the root is given by</p> $C_L(r,t) = C_{L,\infty} - \frac{F(t)}{2} E_1\left(\frac{r^2}{4t}\right), \quad E_1(x) = \int_x^\infty \frac{e^{-y}}{y} dy.$ <p>The above expressions for $F(t)$ and $C_L(r,t)$ give the dimensionless flux and concentration.</p> <p>The dimensional functions can be derived using the scaling presented earlier and they are given by:</p> $F_{\text{dim}}(t_{\text{dim}}) = \frac{2F_m C_{L,\infty}}{1 + C_{L,\infty} + L(t_{\text{dim}}) + \sqrt{4C_{L,\infty} + [1 - C_{L,\infty} + L(t_{\text{dim}})]^2}},$ $C_{L,\text{dim}}(r_{\text{dim}}, t_{\text{dim}}) = C_{L,0} - \frac{2C_{L,0}\lambda}{1 + C_{L,\infty} + L(t_{\text{dim}}) + \sqrt{4C_{L,\infty} + [1 - C_{L,\infty} + L(t_{\text{dim}})]^2}} E_1\left(\frac{(\phi + b) r_{\text{dim}}^2}{\phi D 4t_{\text{dim}}}\right),$ $L(t_{\text{dim}}) = \frac{\lambda}{2} \ln(4e^{-\gamma} \frac{\phi D}{(\phi + b)a^2} t_{\text{dim}} + 1).$ <p>The dimensionless parameters in those equations are still</p> $\lambda = \frac{F_{\text{max}} a}{\theta DK_m} \quad \text{and} \quad C_{L,\infty} = \frac{C_{L,0}}{K_m}.$ <p>A further aspect that the standard Barber model assumes is that there are no soil water saturation gradients around roots and that the soil water content is constant or slowly varying in comparison to the nutrient concentration. Roose and Fowler (2004a) investigated this situation and were able to derive asymptotic expansions to the water uptake by the single root. It was found that the Barber assumptions might be valid for only very specific controlled experimental system.</p>
Do's, don'ts, potential limitations, untested possibilities	<p>The work mentioned above has highlighted the importance of the dimensional analysis and use of matched asymptotic approximations when dealing with single root scale phenomena. In particular, when the Peclet number is small we can neglect the convection term in the main transport equation. However, whether we can neglect the Peclet number term in the boundary condition depends on the value of θ i.e., if $Pe \ll 1$ we can neglect the Peclet number term in the boundary condition, for other cases we have to retain Pe it.</p>
References	<p>Barber, SA. 1995. Soil Nutrient Bioavailability. A Mechanistic Approach. Wiley, New York, 414 pp.</p> <p>Roose, T.; Fowler, A.C. 2004b. A mathematical model for water and nutrient uptake by roots. <i>Journal of Theoretical Biology</i> 228:173-184.</p> <p>Roose, T.; Fowler, A.C. 2004a. A model for water uptake by plants, <i>Journal of Theoretical Biology</i>, 228:155-171.</p> <p>Roose, T.; Fowler, A.C.; Darrah, P.R. 2001. Mathematical model of plant nutrient uptake, <i>Journal of Mathematical Biology</i> 42:347-360.</p> <p>Darrah, P.R.; Roose, T. 2000. Modelling the rhizosphere. In: Pinton, R.; Varanini, Z.; Nannipieri, P. (eds.). <i>The Rhizosphere: Biochemistry and Organic Substances at Soil Plant Interface</i>. Marcel-Dekker Inc., New York, pp. 327-373.</p>
Links	<p>http://www.maths.ox.ac.uk/~roose</p>

ID	51_Roose_b
Author	Roose, Tiina Mathematical Institute, 24-29 St Giles', Oxford OX1 3LB, United Kingdom. roose@maths.ox.ac.uk; ++44 1 865 270 744
Parameter	Plant nutrient uptake
Soil type	Any
Plant species	Any
Model type	Mathematical modelling; analytical approximations; multiscale homogenization of root branching structures and soil processes
Model description	<p>The classic nutrient uptake model of Barber (1995) describes the root system effectively as a single cylindrical sink with the same length and volume as the root system being simulated, but ignoring the variation in root radius, branching and three-dimensional spatial relations. To test the validity of these approximations, Roose and colleagues developed a model for a three-dimensional branched root system allowing for competition between roots and transient-state nutrient transport through the soil using a homogenization methodology based on analytic solutions of the individual root-soil transport equations (Roose et al., 2001; Roose and Fowler, 2004a,b). They found the proper inclusion of branching gave a four-fold greater uptake of P from a defined soil compared with the Barber model for the same root mass and mean root radius.</p> <p>A further aspect not properly treated in the Barber model is the effect of water uptake on nutrient uptake. Although the Barber model allows for convective transport of nutrient towards the root due to water inflow, it does not allow for the decrease in soil water content near the root caused by water uptake. Roose and Fowler (2004b) addressed this issue by calculating changes in soil water content with a separate water uptake model, and allowing for the effects of changes in water content on rates of solute transport (Roose and Fowler, 2004a). The figure shows results for realistic rates of water inflow.</p> <p>These two developments of the Barber model show the necessity of treating all factors associated with nutrient uptake rigorously and on an equal footing within a single mathematical framework.</p>
Do's, don'ts, potential limitations, untested possibilities	<p>The work mentioned above has highlighted the importance of the branching structure in rhizosphere models. Therefore a care should be taken to include sufficient detail about the root size distribution in the soil. In majority of cases the volume averaging of the root structure can lead to model prediction errors of order 30% thus making the direct comparison between the experimental data and model very difficult, if not possible. However, clearly, the computer simulations for field crop situation need to be tractable and fast, therefore exact 3D root architecture cannot and should not be incorporated. Instead, a rigorous homogenization and analysis of processes on different spatial scales and different times scales can be used to derive average equations suitable for the field scale study. Such field scale models will retain a necessary detail about branching structure without making the model intractable analytically or numerically.</p> <p>So far we have developed models that deal with the water and highly buffered nutrient uptake in the soil. The reason why we are able to deal with this is that the movement of water and movement of highly buffered nutrient occur at</p>

	<p>very different timescales. This separation of timescale is very useful for deriving analytical approximations for a single root scale model that can be fed into model on a root system scale. However, the case for nitrite circulation in the soil and uptake by root branching structures proves to be a more significant challenge since the nitrate compounds are very mobile in the soil pore space and therefore their movement cannot be decoupled from the water movement.</p> <p>The next problem to be tackled by the group based in Oxford Mathematics department is to include the effects of root exudates and mycorrhizae to the model for water and highly buffered nutrient uptake. This will open up new avenues for investigating the competitive allocation of carbon resources into those two different pools in comparison to the overall carbon cost of growing and maintaining the root system. This modelling will be done using rigorous upscaling methodology by solving each of those problems separately on a single root scale and then incorporating the single root scale solutions to the root branching structure models. In order to do this modelling in a scientifically consistent manner, an integrated approach is needed where mathematical modelling goes hand in hand with experimental investigation. In particular, there appears to be lack of data from experiments where both, nutrient uptake and root morphology and branching structure, are simultaneously measured. However, as highlighted by our previous studies, there is an urgent need for data in this area, otherwise the models cannot be validated rigorously. Similarly, more data is needed showing mycorrhizae length density profiles in the soil, how these profiles change in time and in response to nutritional status of the plant.</p>
References	<p>Barber, SA. 1995. Soil Nutrient Bioavailability. A Mechanistic Approach. Wiley, New York, 414 pp.</p> <p>Roose, T.; Fowler, A.C. 2004b. A mathematical model for water and nutrient uptake by roots. <i>Journal of Theoretical Biology</i> 228:173-184.</p> <p>Roose, T.; Fowler, A.C. 2004a. A model for water uptake by plants, <i>Journal of Theoretical Biology</i>, 228:155-171.</p> <p>Roose, T.; Fowler, A.C.; Darrah, P.R. 2001. Mathematical model of plant nutrient uptake, <i>Journal of Mathematical Biology</i> 42:347-360.</p> <p>Darrah, P.R.; Roose, T. 2000. Modelling the rhizosphere. In: Pinton, R.; Varanini, Z.; Nannipieri, P. (eds.). <i>The Rhizosphere: Biochemistry and Organic Substances at Soil Plant Interface</i>. Marcel-Dekker Inc., New York, pp. 327-373.</p>
Links	<p>http://www.maths.ox.ac.uk/~roose</p>

ID	51_Schnepf
Author	Schnepf, Andrea Institute of Hydraulics & Rural Water Management, University of Natural Resources and Applied Life Sciences Vienna, Muthgasse 18, 1190 Vienna, Austria; andrea.schnepf@boku.ac.at; ++43 1 36006 5482
Parameter	Concentration gradients of solutes in the rhizosphere, solute uptake by roots
Soil type	Any
Plant species	Any
Model type	Use of pde-solvers (FlexPDE); Single root scale
Model description	Many rhizosphere models are based on solute transport theory and hence partial differential equations (pde's). Users of such models are limited within the capabilities of the respective model. Pde-solvers enable also non-mathematicians to solve a range of pde's and corresponding initial and boundary conditions in a relatively short time, and to modify existing models. If designing a numerical algorithm, pde-solvers can be used for rapid prototyping. A finite element equation solver is FlexPDE (Nelson, 1998). It provides a robust numerical solution technique to systems of nonlinear pde's. The user has to be able to describe PDE's and boundary conditions in the format of a text editor. FlexPDE was tested by Schnepf et al. (2002) and proved to be suitable for current 1 D rhizosphere models.
Do's, don'ts, potential limitations, untested possibilities	<p><i>Advantages:</i> FlexPDE was robust in most cases. Appropriate scaling of variables proved to be helpful. Use of the key word "upwind" in the input file for FlexPDE ensures numerical stability in the presence of convective terms. Adaptive refinement of the finite element mesh is provided. There exists a well moderated user's forum at http://www.flexpde.com.</p> <p><i>Limitations:</i> The numerical solution remains a black box to the user. The finite element method has to be suitable for the problem.</p> <p><i>Untested possibilities:</i> FlexPDE has almost no limitations regarding the shape of the 2D or 3D domain. However, we have only worked in 1D so far, in order to simulate the concentration gradients measured in rhizobox experiments.</p>
References	Nelson, R.G. 1998: www.pdesolutions.com ., Sunol, CA. Schnepf A.; Schrefl, T.; Wenzel, W.W. 2002. The suitability of pde-solvers in rhizosphere modeling, exemplified by three mechanistic rhizosphere models. J. Plant Nutr. Soil Sci. 165: 713-718.
Links	http://www.flexpde.com

ID	51_Seuntjens
Author	Seuntjens, Piet ¹⁾ ; Nowack, Bernd ²⁾ ; Schulin, Rainer ²⁾ ¹⁾ VITO, Flemish Institute for Technological Research, Boeretang 200, 2400 MOL, Belgium; piet.seuntjens@vito.be; ++32 14 33 59 51 ²⁾ Institute of Terrestrial Ecology (ITOE), ETH Zürich, Universitätstrasse 16, CH-8092 Zürich, Switzerland
Parameter	Root-zone uptake and leaching of trace elements in the presence of organic ligands
Soil type	Generic model soil consisting of quartz sand with 2% goethite
Plant species	Generic model plant
System	Soil column
Model type	Speciation and transport modeling
Model description	<i>Numerical model</i> The calculations were made using the hydrogeochemical model PHREEQC2. Chemical interactions for each element were calculated separately from the transport part for each time step. <i>Upscaling microscopic rhizosphere processes to macroscopic plant uptake and leaching</i> Typical microsite processes such as diffusion to roots, root-uptake, ligand exudation, were calculated imposing kinetic sink terms in each macroscopic grid cell. Data on root uptake and exudation kinetics, ligand degradation, were obtained from microscopic rhizosphere studies. Root properties were normalized to the standard units (L water) of the macroscopic grid cells. This allowed to calculate simultaneous processes such as vertical transport, root uptake and root exudation.
Do's, don'ts, potential limitations, untested possibilities	<i>Methodological restraints</i> In the description of diffusion towards the root a formula is used that combines diffusion of the ligand and the free ion into a lumped diffusion coefficient. This is a relatively poor representation of the root uptake process, since no mass flow is included and depletion cannot be described. In a follow up modeling experiment, this diffusion and mass flow problem is simulated and verified against other codes. The integration of the two modeling approaches will allow to describe root uptake more accurately. <i>Applicability of the model</i> The model is a research model that helps to design rhizosphere experiments. It has been developed for a synthetic soil, with well-known constituents. It has not been tested against less-defined real world experiments. The model can easily be extended to soils for which isotherms in the presence or absence of ligands are determined. Literature review showed however that relatively few data on trace element sorption in the presence of ligands are available.
References	<i>Root zone model development</i> Seuntjens, P.; Nowack, B.; Schulin, R. 2004. Root-zone modeling of heavy metal uptake and leaching in the presence of organic ligands. Plant and Soil 265: 61-73. <i>Modeling single root uptake</i> Nowack, B.; Mayer, K. U.; Oswald, S. E.; Van-Beinum, W.; Appelo, C. A. J.; Jacques, D.; Seuntjens, P.; Gérard, F.; Jaillard, B.; Schnepf, A.; Roose, T.

2006. Verification and intercomparison of reactive transport codes to describe root-uptake. *Plant and Soil* 285: 305-321.

Additional information

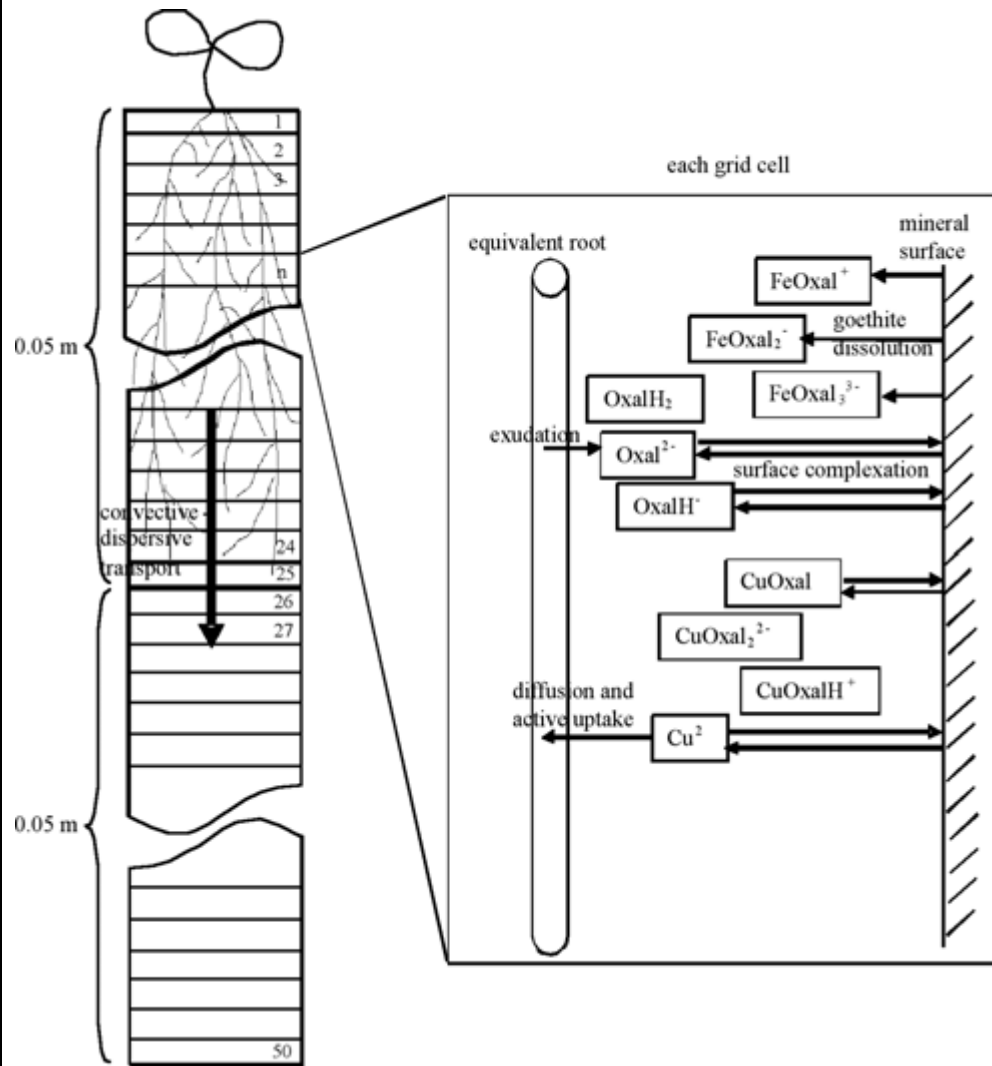

Fig. 1: from Seuntjens et al. (2004); with kind permission of Springer Science and Business Media.

ID	51_Silk
Author	Silk, Wendy K. Dept. Of L.A.R., University of California, Davis CA 95616-8627 wksilk@ucdavis; 001 530 752 0686
Parameter	Chemical fields in the rhizosphere
Soil type	Any
Plant species	Any
Model type	Root efflux coupled with transport
Model description	<p><i>Spatial, temporal, and material aspects:</i> To understand spatial and temporal aspects of rhizosphere function, three points of view should be considered (Kim et al., 1999; Silk, 2002; Watt et al., 2006). From the point of view of the moving root tip, we see a chemical field surrounding the tip during movement to deeper soil layers. A complementary perspective is the point of view of the stationary point in the soil that will eventually lie beside a mature root cell. The fixed soil point will experience the processes associated with a neighboring root element, so that fluxes corresponding to the different root locations will be encountered in a predictable sequence. If the root tip is moving 0.5 mm h⁻¹ downward, every half-hour the flux into or from the soil particle will be for a root element that is located 0.25 mm farther from the root tip. Thus the “age” of the rhizosphere can be quantified in terms of the time that has elapsed since the root tip passed the soil point (Kim et al., 1999; Watt et al., 2006). The third perspective is that of a real or “material” particle attached to a cell initially on the surface of the root tip (Silk and Erickson, 1979; Silk, 2002). With time the particle and cell accelerate away from the tip to reach a displacement velocity equal to the root elongation rate, as the cell decelerates to a final fixed location in the soil profile. Note that the novelty of this approach is the attention given to spatial (site specific) and material (particle specific) aspects of rhizosphere development and function.</p> <p><i>Chemical fields in the rhizosphere of the root tip:</i> For a non biodegradable substance, the shape and chemical concentration pattern of the chemical plume carried by the root tip in soil can be calculated with information on spatial patterns of flux into/from the root, diffusivity <i>D</i> of the substance in the soil, and elongation rate <i>V</i> of the root (Kim et al., 1999). We can simplify the problem by imagining a stationary root, surrounded by a moving soil medium which is flowing 0.5 mm h⁻¹ upward. Solving for the chemical field around the moving growth zone involves following a slice of soil as it moves upward, keeping track of the history of the radial profile and updating the chemical flux and diffusion over time as the soil encounters the older tissue elements (Kim et al., 1999; Nichol and Silk, 2001)The equation is</p> $\frac{\partial [H]}{\partial t} = V \frac{\partial [H]}{\partial x} + D \left[\frac{1}{r} \frac{\partial [H]}{\partial r} + \frac{\partial^2 [H]}{\partial r^2} + \frac{\partial^2 [H]}{\partial x^2} \right]$ <p>Where [<i>H</i>] is the concentration of the substance of interest, <i>x</i> is longitudinal distance from the root tip and <i>r</i> is radial distance from the root surface. Boundary conditions are the reported exudate efflux from the root surface. The equation, used with empirical data on proton efflux and root growth rates, was solved to predict successfully the pH field in the rhizosphere of maize. The dimensionless Peclet number $P=Vs/D$, where <i>s</i> is a scale factor on the</p>

	<p>order of 1 mm for many roots, is the ratio of the time scales of diffusion and growth-associated convection. The diameter of the rhizosphere of the root tip was shown to increase with the reciprocal of P. Root growth zones affected soil pH (low diffusivity) only on the mm scale but affected agar pH (high diffusivity) to a distance of several cm. A rhizosphere number $R = (D/Vs)^{0.5}$ should be useful for predicting the size of the rhizosphere around the tip and the time for the plume to stabilize after establishment of particular environmental conditions. This notion is related to the arguments developed in the historical literature, that the root affects the spatial patterns of different nutrients in different ways. The boundary of the rhizosphere varies with the diffusivity of the substance of interest - it does not make sense to speak of a general "rhizosphere boundary." The difference between the Silk models and other models in the literature is that we use a moving reference frame and explicitly incorporate the growth velocity, so that the geometry and chemistry of the rhizosphere can be shown as a function of position relative to the (moving) tip. Following the path of the tip moving through the soil, with simple growth observation experiments, can then be used to visualize the pattern in the soil profile. It is instructive to recognize that the logarithmic growth of the rhizosphere shown in the Nye models can be seen as a spatial increase in diameter in the models of Silk et al. That is, if we look back from the tip we may see a widening of the rhizosphere. This would be the growth in the extent of the rhizosphere seen at a fixed location in the soil, since the soil point is progressively farther from the root tip with time.</p>
References	<p>Silk, W.K.; Erickson, R.O. 1979. Kinematics of Plant Growth. <i>Journal of Theoretical Biology</i> 76: 481-501.</p> <p>Kim, T.K.; Silk, W.K.; Cheer, A.Y. 1999. A mathematical model for pH patterns in the rhizospheres of growth zones. <i>Plant, Cell and Environment</i> 22: 1527-1538.</p> <p>Nichol, S. A.; Silk, W.K. 2001. Plant Cell Environment Empirical evidence of a convection-diffusion model for pH patterns in the rhizospheres of root tips. <i>Plant, Cell and Environment</i> 24: 967-974.</p> <p>Silk, W.K. 2002. Kinematics of Primary Growth. In: Waisel, Y.; Eshel, A. (eds.) <i>Plant Roots: the Hidden Half</i>, Third edition. Marcel Dekker, New York, pp. 113-126.</p> <p>Watt, M.; Silk, W.K.; Passioura, J. 2006. Rates of root and organism growth, soil conditions, and temporal and spatial development of the rhizosphere. <i>Annals of Botany</i> 97: 839-855.</p>

ID	51_Steingrobe
Author	Steingrobe, Bernd; Claassen, Norbert Georg-August University, Department of Crop Science, Plant Nutrition, Carl-Sprengel-Weg 1, 37075 Göttingen, Germany bsteing@gwdg.de; ++49-551-395548 nclaass@gwdg.de; ++49-551-395569
Parameter	Modelling nutrient transport in soil and plant uptake
Soil type	Any
Plant species	crop species
Model type	NST 3.0; transport model
Model description	<p>The model is based on the transport equation of Nye and Marriott:</p> $\frac{\partial C}{\partial t} = \frac{1}{r} \frac{\partial}{\partial r} (r D_e b \frac{\partial C_L}{\partial r} + v_0 r_0 C_L)$ <p>with $D_e = D_L \Theta f \frac{1}{b}$;</p> <p>buffer power b is calculated according to a Freundlich equation: $C = b C_L^a + c$</p> <p>Inflow is calculated by Michaelis-Menten kinetics: $I_n = \frac{I_{max} (C_L - C_{Lmin})}{K_m + C_L - C_{Lmin}}$</p> <p><i>Input parameters:</i> D_L Diffusion coefficient in water Θ soil volumetric water content f tortuosity or impedance factor v_0 water flow at the root surface C_{Li} initial soil solution concentration a, b, c fitting parameter of Freundlich function I_{max} maximum inflow per root surface area K_m Michaelis constant C_{Lmin} minimum concentration r_0 root radius r_1 average half distance between two roots</p> <p>The model calculates inflow and uptake of 1 cm root. When root length at the beginning and root growth rate is given, average inflow and total uptake of a growing root system can be calculated.</p> <p><i>Model assumptions:</i></p> <ul style="list-style-type: none"> • no nutrient flux at r_1 • $\Theta, f, v_0, I_{max}, K_m, C_{Lmin}, r_0$ and r_1 are constant during the calculation • C_{Li} – the initial soil solution concentration is the same in the whole soil volume • root distribution is homogenous <p><i>Output:</i> Nutrient inflow and uptake with time, development of depletion zones around the roots.</p>

Do's, don'ts, potential limitations, untested possibilities	<ul style="list-style-type: none"> • The model is tested and widely used for P and K. It is also used for nitrate for teaching. Experiences for other nutrients is limited. • Uptake of root hairs can be considered using a quasi-steady state approach with the following input parameters: Root hair radius, half distance between two root hairs in different distances to the root surface, Michaelis-Menten parameter of root hairs.
References	<p><i>Validation:</i> Claassen, N.; Syring, K.-M.; Jungk, A. 1986. Plant Soil 95: 209-220.</p> <p><i>Description of the underlying processes:</i> Claassen, N., 1990. Nährstoffaufnahme höherer Pflanzen aus dem Boden, Severin Verlag, Göttingen.</p> <p>Jungk, A.; Claassen, N. 1997. Adv. Agronomy 61: 53-109.</p> <p>Claassen, N.; Steingrobe, B. 1999. In: Rengel, Z. (ed.) Mineral nutrition of crops. Haworth Press, Inc., New York, pp. 327-367.</p> <p><i>Use of Freundlich function:</i> Steingrobe, B.; Claassen, N.; Syring, K.-M. 2000. J. Plant Nutr. Soil Sci. 163: 459-465.</p>
Links	The model can be downloaded: www.gwdg.de/~uaac (click 'Aktuell' and 'download')

ID	51_VanBeinum
Author	Van Beinum, Wendy Central Science Laboratory, Sand Hutton, York YO41 1LZ, United Kingdom, w.vanbeinum@csl.gov.uk; ++44 1904 462437
Parameter	Concentration gradients of solutes in the rhizosphere, solute uptake by roots
Soil type	Any
Plant species	Any
Model type	ORCHESTRA, a coupled chemical equilibrium – transport model; single root scale
Model description	ORCHESTRA is a modelling framework developed by Meeussen (2003) that facilitates modelling chemical speciation in combination with transport. A model was implemented to simulate Michaelis-Menten uptake by a single root, radial diffusion towards the root, and release of solutes from the soil surrounding the root (buffering). The latter was modelled by a simple equilibrium sorption reaction. Radial diffusion was solved with a finite difference numerical method by dividing the soil surrounding the root into concentric layers. Diffusion between the layers is calculated for small time steps. The numerical method was optimised by increasing the thickness of the layers with the distance from the root. The cumulative uptake in time, and the concentrations in the soil at the end of the simulation, are given as output for each solute. A description of the model can be found in Nowack et al. (2006).
Do's, don'ts, potential limitations, untested possibilities	<p><i>Possibilities:</i> The model can be extended to include convective transport towards the root, alternative uptake mechanisms, exudation of solutes by the root and interactions between solutes (e.g. complexation in soil solution, competitive sorption). An example is the model by Geelhoed et al. (1999) that describes the influence of citrate exudation on the uptake of phosphate (Nowack et al., 2006). Other processes that can be included are for example mineral precipitation/dissolution, kinetic reactions such as degradation and more advanced surface complexation reactions.</p> <p><i>Advantages:</i> The advantage of ORCHESTRA is that the model structure and equations are completely user-defined. Experienced users will be able to adjust or add model descriptions according to requirement.</p> <p><i>Disadvantages:</i> The existing ORCHESTRA software is not easy to use for non-experienced users. A more comprehensive user interface, example models and short course are in development. A disadvantage for numerical transport modelling is that the optimum time step and number of layers have to be checked manually.</p> <p><i>Do's and don'ts:</i> When modelling in ORCHESTRA, start with an existing example model and make adjustments gradually. Always test if the adjusted or added processes give the expected output. Test the accuracy of a numerical solution by varying the number of layers and time-steps. The results should not change significantly if the number of layers or time steps is doubled.</p>

References	<p>Meeussen, J.C.L. 2003. ORCHESTRA: An object-oriented framework for implementing chemical equilibrium models. <i>Environmental Science & Technology</i> 37: 1175-1182.</p> <p>Nowack, B.; Mayer, K. U.; Oswald, S. E.; Van-Beinum, W.; Appelo, C. A. J.; Jacques, D.; Seuntjens, P.; Gérard, F.; Jaillard, B.; Schnepf, A.; Roose, T. 2006. Verification and intercomparison of reactive transport codes to describe root-uptake. <i>Plant and Soil</i> 285: 305-321.</p> <p>Geelhoed, J.S.; van Riemsdijk, W.H.; Findenegg G.R. 1999. Simulation of the effect of citrate exudation from roots on the plant availability of phosphate adsorbed on goethite. <i>European Journal of Soil Science</i> 50: 379-390.</p>																
Links	<p><i>The model is available on the ORCHESTRA website:</i> http://www.meeussen.nl/orchestra</p>																
Additional information	<div data-bbox="478 660 1340 1164" data-label="Figure"> <table border="1"> <caption>Data points estimated from Figure 1</caption> <thead> <tr> <th>Distance from root (cm)</th> <th>Concentration in soil (mol m⁻³)</th> </tr> </thead> <tbody> <tr><td>0.0</td><td>0.0</td></tr> <tr><td>0.1</td><td>0.6</td></tr> <tr><td>0.2</td><td>1.0</td></tr> <tr><td>0.5</td><td>1.5</td></tr> <tr><td>1.0</td><td>1.75</td></tr> <tr><td>1.5</td><td>1.8</td></tr> <tr><td>2.0</td><td>1.8</td></tr> </tbody> </table> </div> <p>Fig. 1: Concentration of potassium near the root after simulation of 120 days potassium uptake by the root</p>	Distance from root (cm)	Concentration in soil (mol m ⁻³)	0.0	0.0	0.1	0.6	0.2	1.0	0.5	1.5	1.0	1.75	1.5	1.8	2.0	1.8
Distance from root (cm)	Concentration in soil (mol m ⁻³)																
0.0	0.0																
0.1	0.6																
0.2	1.0																
0.5	1.5																
1.0	1.75																
1.5	1.8																
2.0	1.8																

ID	51_VanBodegom
Author	Van Bodegom, Peter Institute of Ecological Science, Vrije Universiteit Amsterdam, de Boelelaan 1085, 1081 HV Amsterdam, the Netherlands peter.van.bodegom@ecology.falw.vu.nl; ++31 20 5986964;
Parameter	Modelling methane oxidation in the rhizosphere
Soil type	Any, anoxic conditions
Plant species	adapted to anoxic conditions
Model type	Numerical modelling
Model description	<p><i>Processes to be considered</i> Methane is produced in anoxic systems with inherently low diffusion rates where it may reach high concentrations. Methane emission is strongly mitigated by plant roots that provide carbon substrates (exudates), substrate for oxidation (O₂ through root oxygen loss) and a gas transport medium (aerenchyma channels). The rhizosphere thus has high O₂ influx rates, with concomitantly high O₂ consumption rates by chemical and microbial oxidation processes, including the oxidation of methane diffusing from the anaerobic soil into the rhizosphere.</p> <p><i>The modelling approach</i> A cylindrical geometry around a root is assumed. The concentration C of species j at each distance r from roots i is given by:</p> $\frac{\partial C_{i,j}}{\partial t} = \text{production}_{i,j} - \text{consumption}_{i,j} + \text{net transport}_{i,j} \quad (1)$ <p>Generally, iron oxidation is the most important chemical oxidation process. Neglecting other chemical reactions, iron oxidation is described by first order kinetics, which is commonly used in geochemical models:</p> $R_{FeOx} = k_{Feox} \cdot Fe^{2+} \cdot O_2 \quad (2)$ <p>in which k_{Feox} is the iron oxidation kinetic constant. Methane oxidation and heterotrophic respiration - simplified to the oxidation of acetate, the most important organic acid in rhizospheres - are microbially mediated and described by double Monod kinetics:</p> $\mu_j = \mu_{max,j} \cdot \frac{O_2}{K_{sO_2,j} + O_2} \cdot \frac{C_j}{K_{sC,j} + C_j} \quad (3)$ <p>in which μ is the relative growth rate of micro-organisms and μ_{max} its maximum value, K_s is a kinetic constant and j stands for either acetate or methane. The resulting oxidation rates are:</p> $R_{AcOx/MeOx} = \mu_j \cdot B_j \cdot \frac{\nu_j - Y_j}{Y_j} \quad (4)$ <p>in which B represents microbial biomass, ν a stoichiometry coefficient and Y the microbial yield coefficient. Double Monod kinetics allows both substrates to be limiting and allows changes in maximum conversion rates under influence of microbial growth, which is not possible when applying a Michaelis-Menten equation. Other microbial processes included are Fe³⁺ reduction to Fe²⁺ and acetate reduction to methane. Both reactions are inhibited by O₂ and are described by equations similar to Eq. (3) with an additional inhibition term $1/(1+K_{ij} \cdot O_2)$ in which K_i is the inhibition constant.</p>

	<p>Finally, acetate is produced by mineralisation. Iron adsorption processes and pH regulation are described elsewhere. Transport is driven by diffusion, neglecting dispersion and convective flows that are unimportant in small-scale water-saturated systems:</p> $R_{diff,j} = D_{eff,j} \cdot A_i \cdot \frac{\partial C_j}{\partial r} \quad (5)$ <p>in which A_i is the cross section area and D_{eff} the effective diffusion coefficient, given by:</p> $D_{eff,j} = D_{w,j} \cdot \tau_B \cdot \theta^{\tau_A} \quad (6)$ <p>in which D_w is the diffusion coefficient in water, θ water filled porosity and τ_A and τ_B tortuosity coefficients defining path length extension due to soil particles.</p> <p><i>Boundary conditions</i> Acetate flows into the rhizosphere by root exudation. Methane, O₂ and H⁺ - assumed to have constant concentrations in the root - diffuse through the root epidermis. In addition, H⁺ is released actively from the root to balance plant uptake of ammonia. It is assumed that iron does not exchange with the root. It is also assumed that there is equilibrium at the interface with the bulk soil with no net exchange. The whole set of equations and boundary conditions can be implemented in any numerical environment.</p>
Do's, don'ts, potential limitations, untested possibilities	<p><i>Limitations</i></p> <ul style="list-style-type: none"> • Each of the process descriptions is a simplification of reality and may be refined. • The process, and consequently the model, of high-affinity methane oxidation in aerobic soils is different. Similarly, the model cannot be used for anaerobic oxidation of methane, e.g. in marine sediments, by SO₄²⁻ instead of O₂. • Steady state conditions with the bulk soil may not always be true, because roots grow, taking the aerobic zone with them. • Parameterisation may be system-specific.
References	<p><i>Complete model description:</i> van Bodegom, P.M.; Leffelaar, P.A.; Goudriaan, J. 2001. Biogeochemistry 55: 145-177.</p> <p><i>Extended models on one or more sub-processes:</i> van Bodegom, P.M.; Groot, T.; van den Hout, B.; Leffelaar, P.A.; Goudriaan, J. 2001. J. Geophys. Res. 106D: 20861-20873 Segers, R. 2001. J. Geophys Res. 106D: 3511-3528 Rappoldt, C. 1993. Geoderma 57: 69-88</p>

Colour Plates

Summary 5.1. Rhizosphere Models (p. 101)

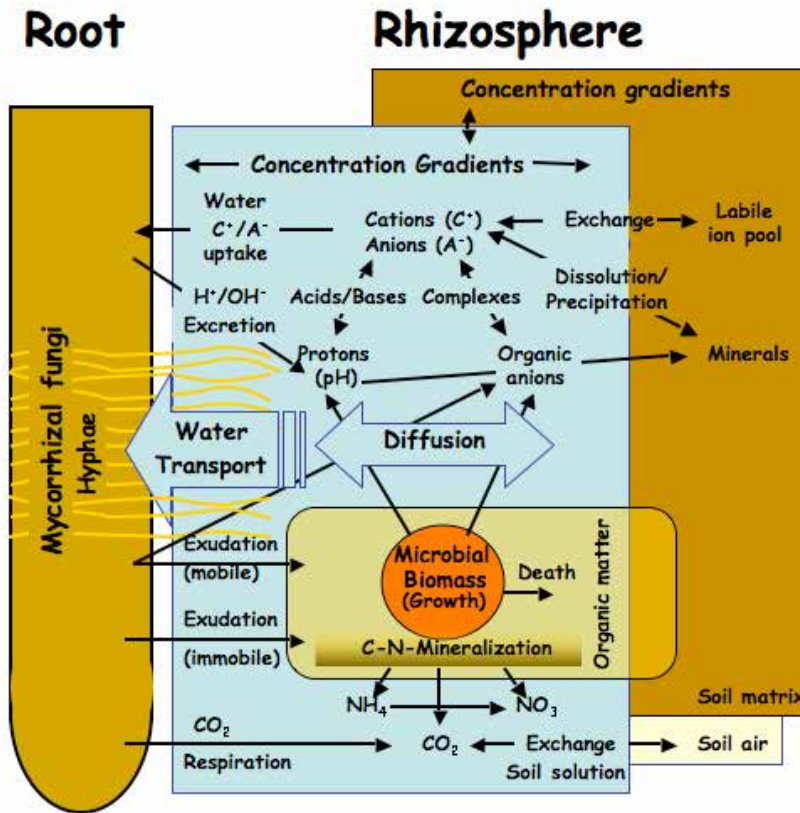

Fig.1: Schematic representation of major processes in the rhizosphere

11_EI_Azab (p. 125)

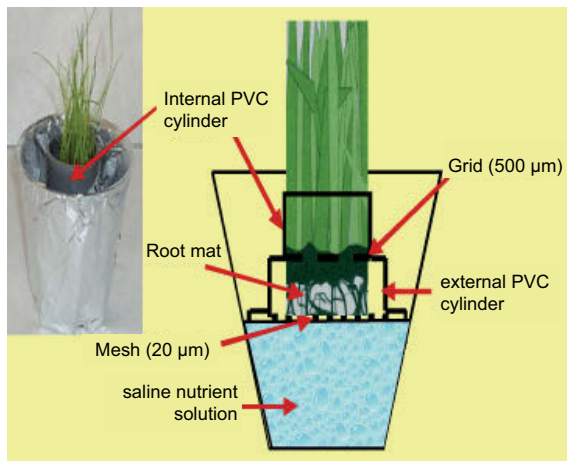

Fig. 1. Preculture Stage

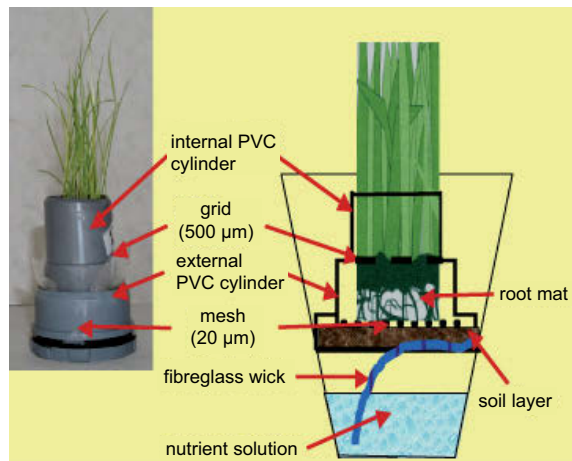

Fig. 2. Soil-Contacting Stage

Colour Plates

11_Hacin (p. 134)



Fig. 2. Split-root growth assemblies arranged in home made racks - from wood and Al wire

Colour Plates

11_Neumann (p. 144)

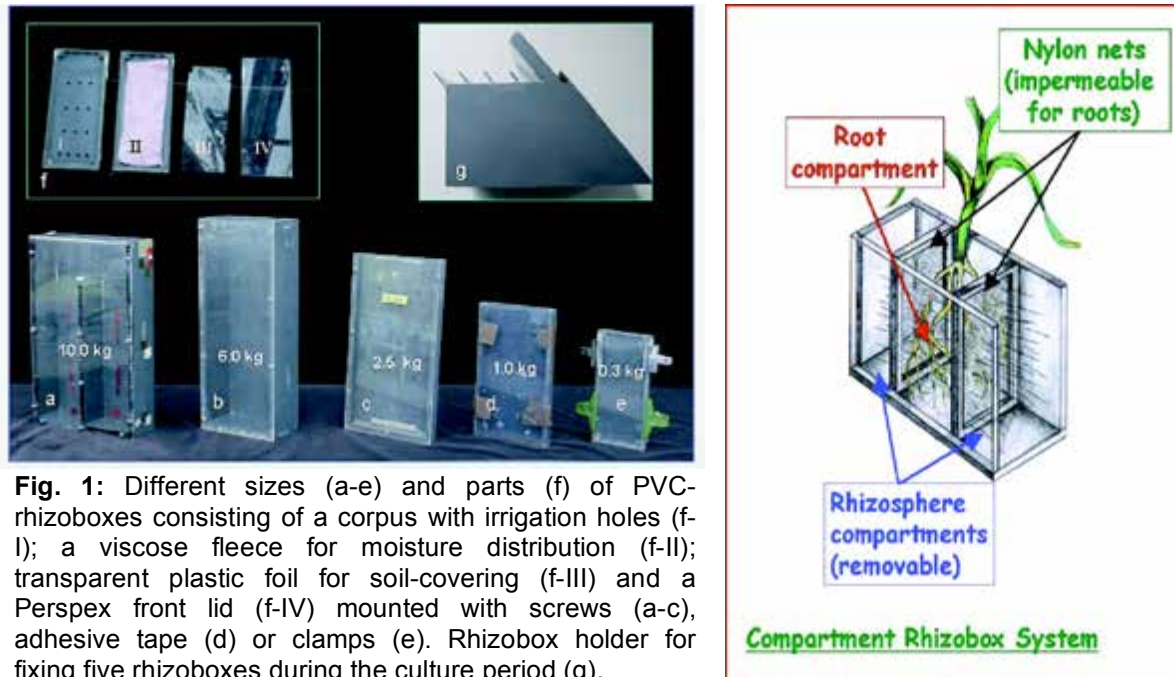

Fig. 1: Different sizes (a-e) and parts (f) of PVC-rhizoboxes consisting of a corpus with irrigation holes (f-I); a viscose fleece for moisture distribution (f-II); transparent plastic foil for soil-covering (f-III) and a Perspex front lid (f-IV) mounted with screws (a-c), adhesive tape (d) or clamps (e). Rhizobox holder for fixing five rhizoboxes during the culture period (g).

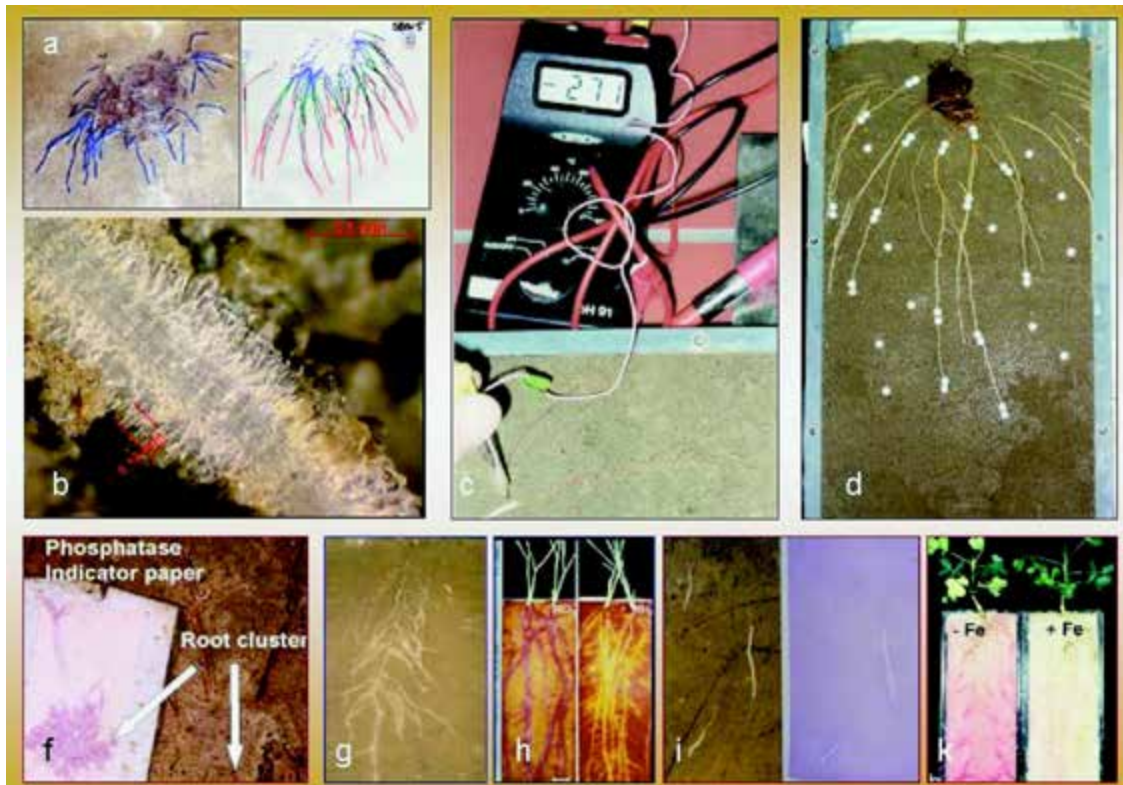

Fig. 3: Rhizobox applications: Monitoring of root growth (a); length measurements of root hairs (b); determination of rhizosphere pH with antimony micro-electrodes (c); collection of rhizosphere soil solution with filter paper (d); detection of root-induced chemical changes: acid phosphatase activity (f); Mn-reduction with Mn-oxide indicator paper; pH-changes with bromocresol-purple agar (h); aluminium complexation with aluminon-agar; iron-III reduction with BPSD-agar (for details see chapter 3.1.: Root exudates and organic composition of plant roots).

Colour Plates

12_Hargreaves (p. 155)

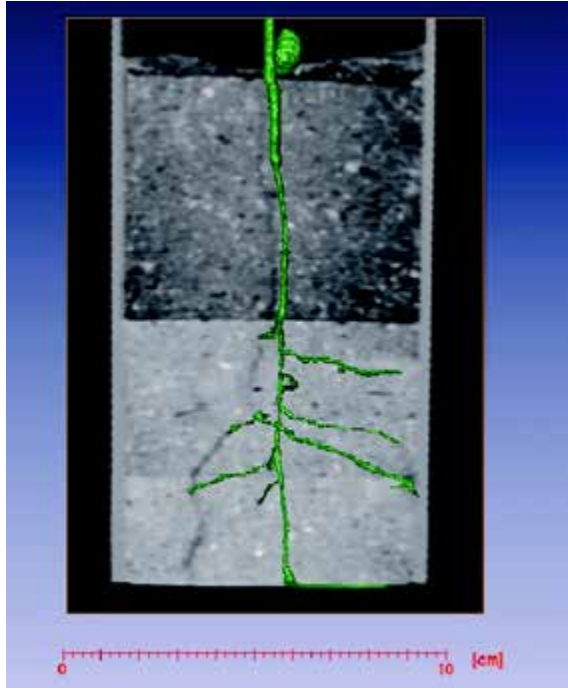

Fig. 1a. 14-day Lupin root in 1 and 4Mpa soil Adelaide Medical CT.



Fig. 1b. Two 3-day-old wheat seedlings, Reading micro CT.

12_Himmelbauer (p. 158)

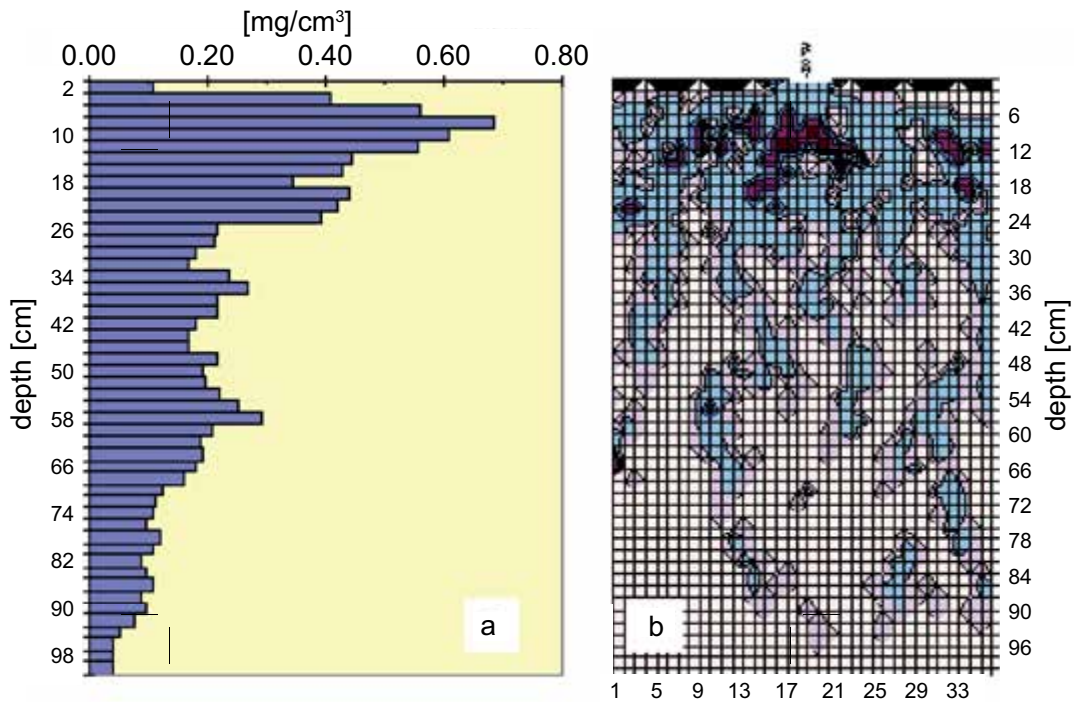
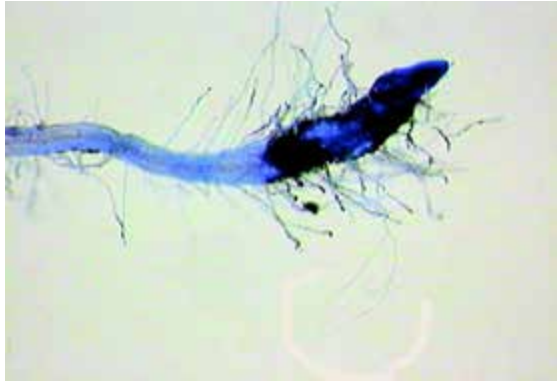

Fig. 1. Root profile distribution expressed as a) dry mass density and b) index related to the number and size of the visible roots per square (*Zea mays* L., Sarnevo, Bulgaria, 1993).

Colour Plates

12_Loes (p. 163)

The figure below demonstrates that fungal hyphae may be visible at the magnification that is used for measuring root hair length. The root was stained to study possible infections by mycorrhizal fungi. The thread-like structure below the root tip is branched, whereas root hairs are normally not branched. Hence, this structure is most probably a hyphae.



It is possible that it is a *Rhizoctonia spec.*, because this fungus has relatively thick hyphae with a characteristic branching. Some normal root hairs can be seen to the left on the picture, whereas the root hairs close to the tip seem to be damaged (due to fungal infection?) and therefore more heavily stained.

Picture: Anne-Kristin Løes.

21_McNear (p. 205)

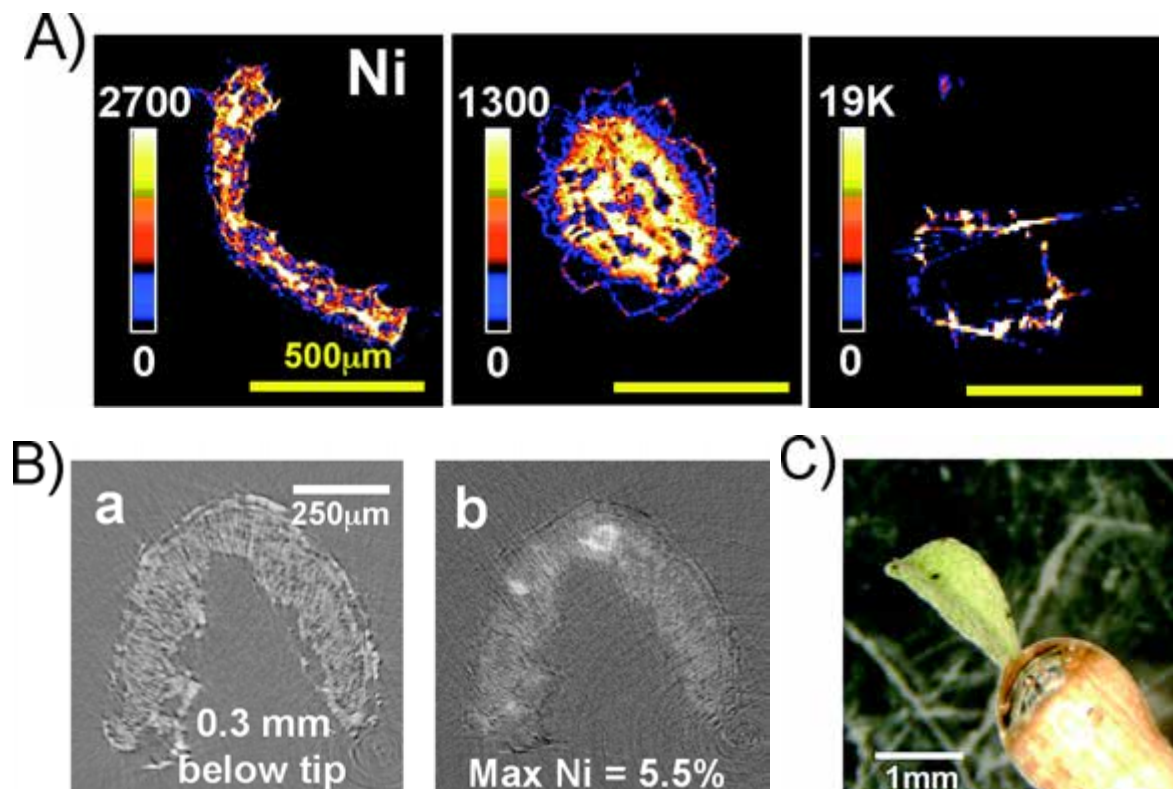

Figure 1: A) Ni concentrations (ppm dry weight) and micro-distributions in a leaf, stem and root acquired by F-CMT; B) captured frames from AE-CMT movie showing the Ni conc. (% wet weight) and distribution (brighter regions) 0.3 mm below the tip of an *Alyssum murale* "Kotodesh" leaf; C) leaf mounted in epoxy resin on the end of wooden shaft for analysis via F-CMT

Colour Plates

21_Tappero (p. 210)

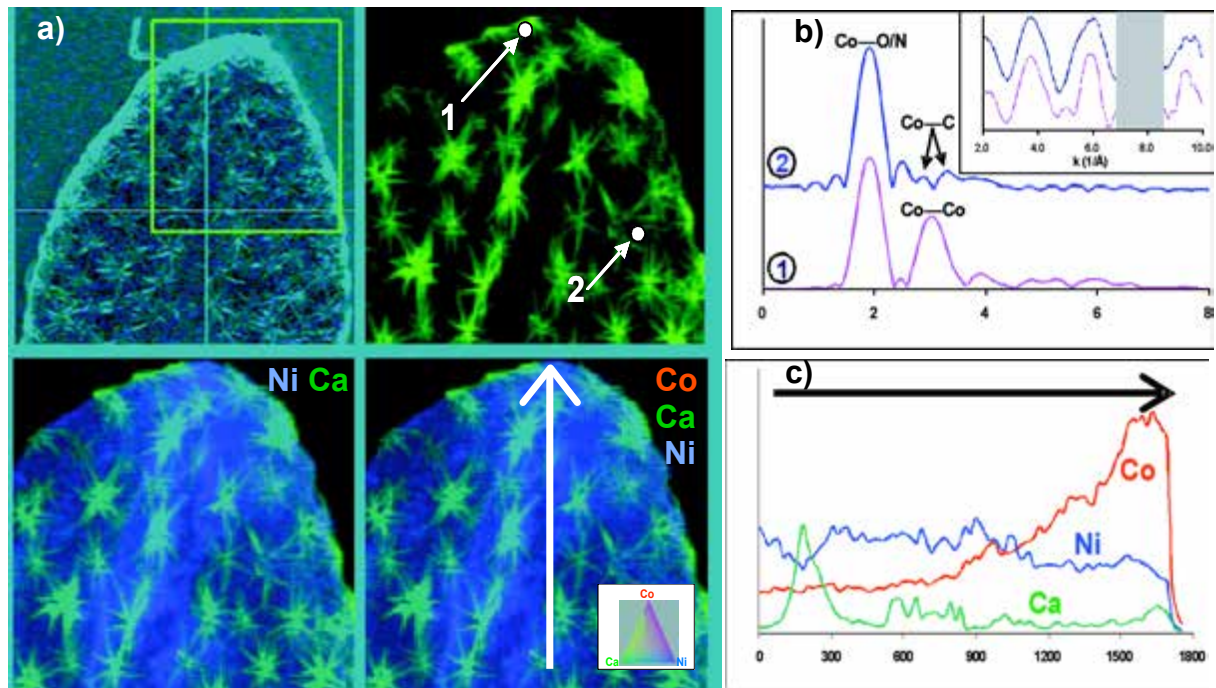

Fig. 1. μ -SXRF images (Co, Ni) of a fresh, hydrated leaf from hyperaccumulator *Alyssum murale* (a), Co-XAFS k^3 -weighted chi (inset) and corresponding Fourier transforms (b) for the leaf tip and mid-leaf region, and line spectra (Co, Ni, Ca) for the region indicated (arrow) on the tricolor SXRF image (c).

22_Tappero (p. 236)

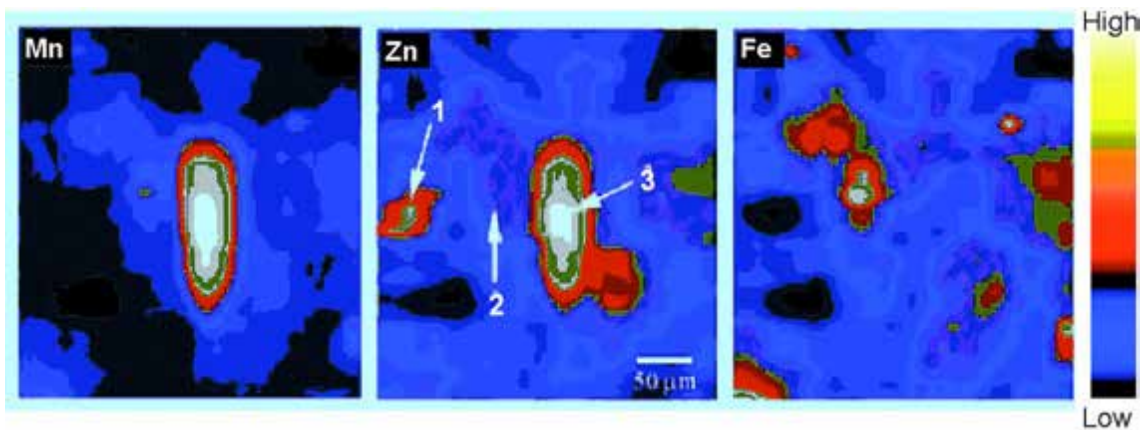

Figure 1. m-SXRF images for subsurface soil from a Zn smelter (reprinted in part with permission from Roberts, D.R.; Scheinost, A.C.; Sparks, D.L. 2002. Zinc speciation in a smelter-contaminated soil profile using bulk and microspectroscopic techniques. *Environ. Sci. Technol.* 36:1742-1750.; Copyright (2002) American Chemical Society).

Colour Plates

23_Hinsinger_a (p. 255)

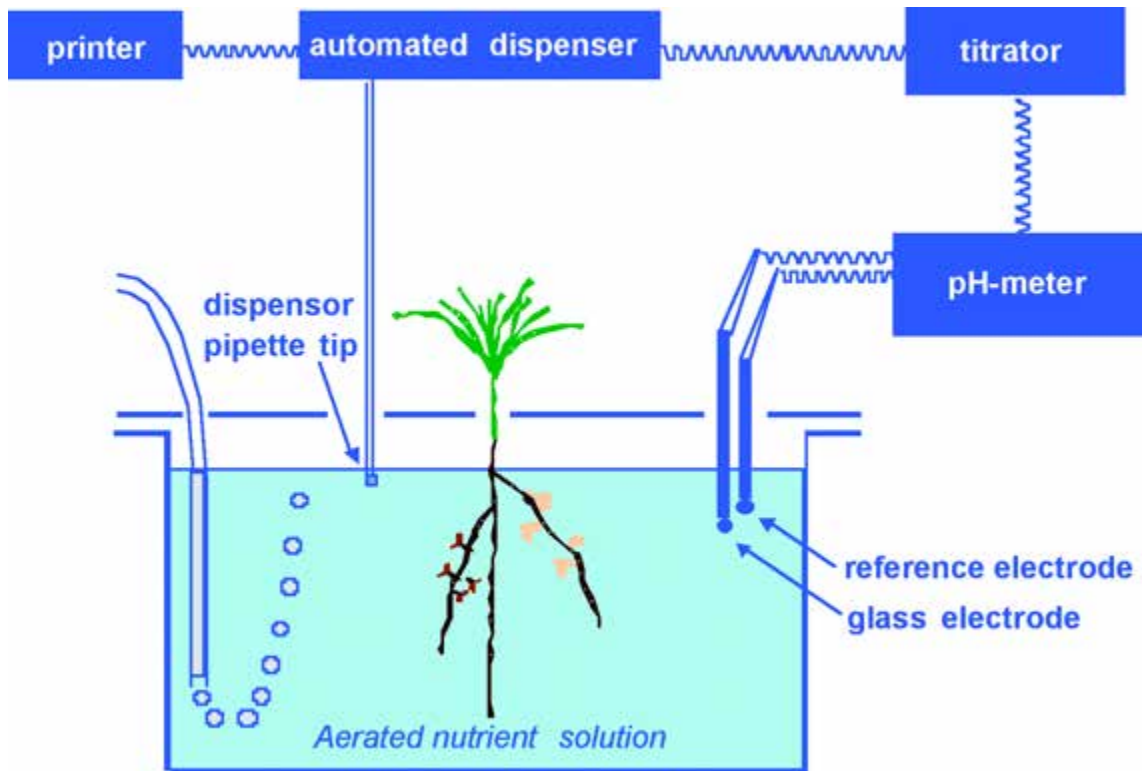
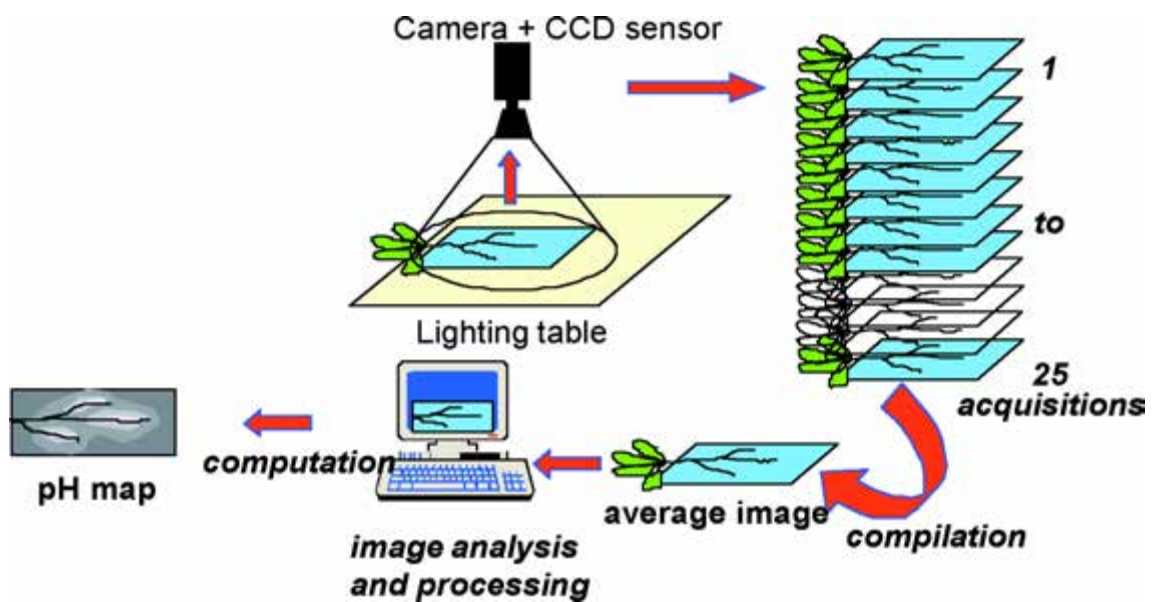

Fig. 1. Experimental set-up for continuous monitoring of proton efflux/influx from roots grown in hydroponics at a given pH values (pH-stat device).

23_Hinsinger_b (p. 257)



Colour Plates

23_Loes (p. 264)

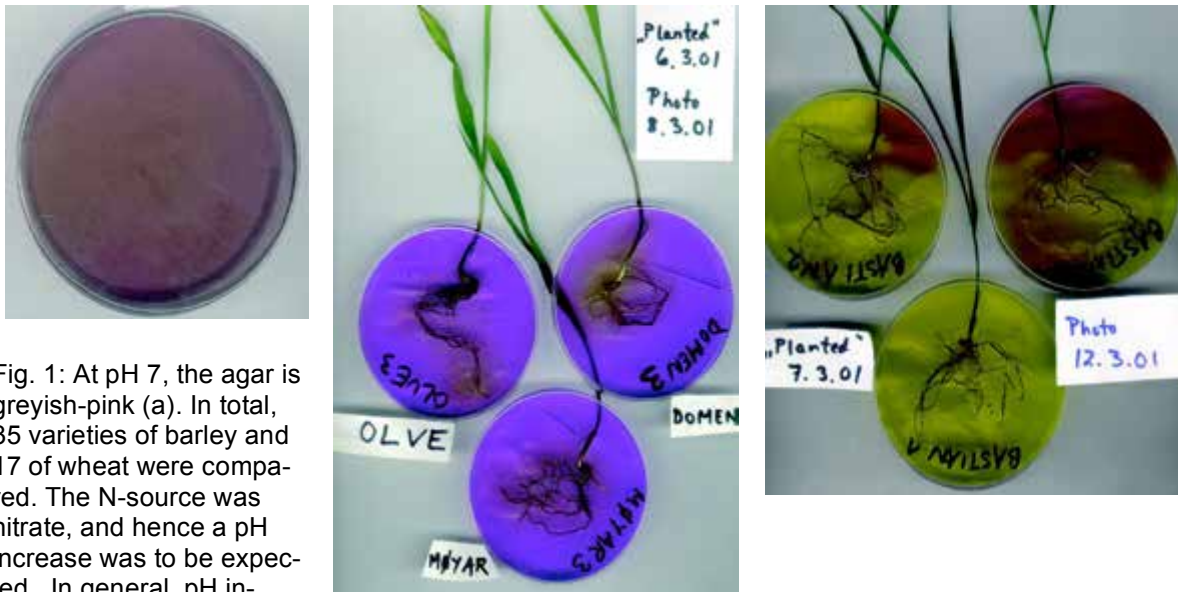
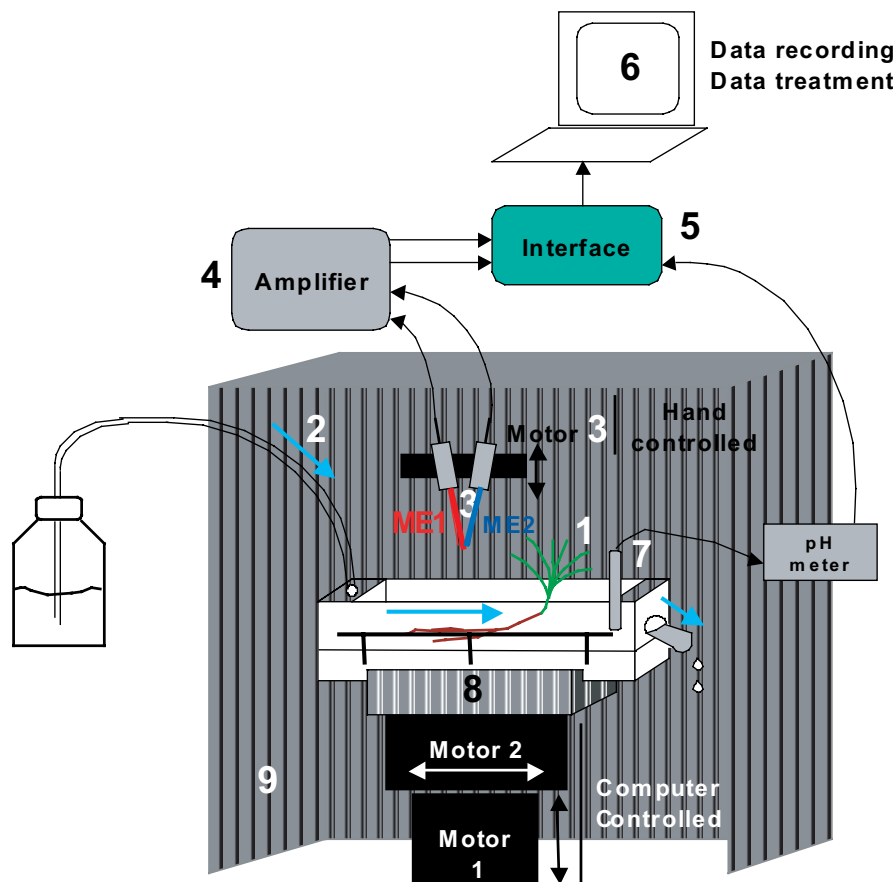

Fig. 1: At pH 7, the agar is greyish-pink (a). In total, 35 varieties of barley and 17 of wheat were compared. The N-source was nitrate, and hence a pH increase was to be expected. In general, pH increased in barley (blue agar; b), but decreased in wheat (yellow agar, c).

23_Plassard (p. 270)

Fig. 1. Experimental set-up for continuous monitoring of ion fluxes using ion-selective microelectrodes.

- 1: Intact plant in a perspex cuvette,
- 2: flowing solution,
- 3: ion-selective microelectrodes plugged in head-stages and moved by a hand-controlled motor, 4: amplifier,
- 5: interface (McLab),
- 6: computer (Mac Intosh), 7: combined pH-macroelectrode,
- 8: mobile plate moving the cuvette using computer controlled motors,
- 9: Faraday cage



Colour Plates

23_Sauve_b (p. 277)

Fig. 1.: Polarograms
Used for a sample
calibration curve

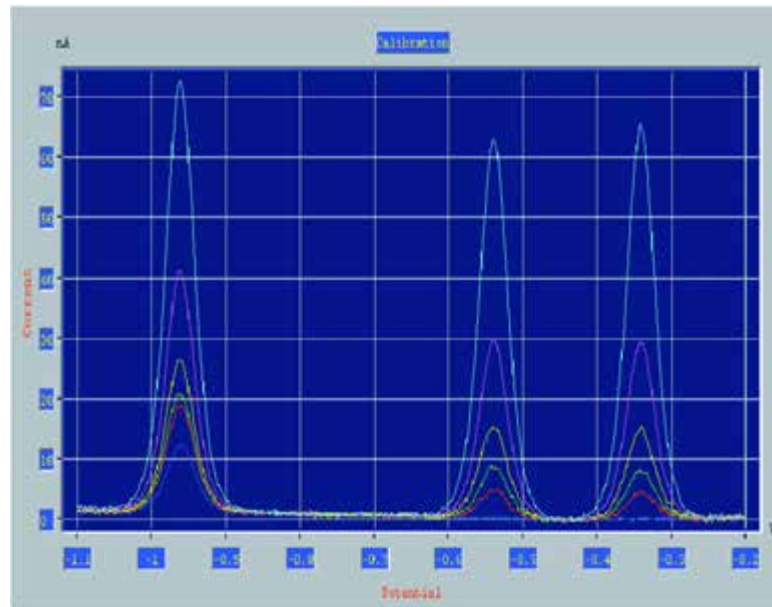

23_Temminghoff (p. 278)

Donnan Membrane Technique (DMT)

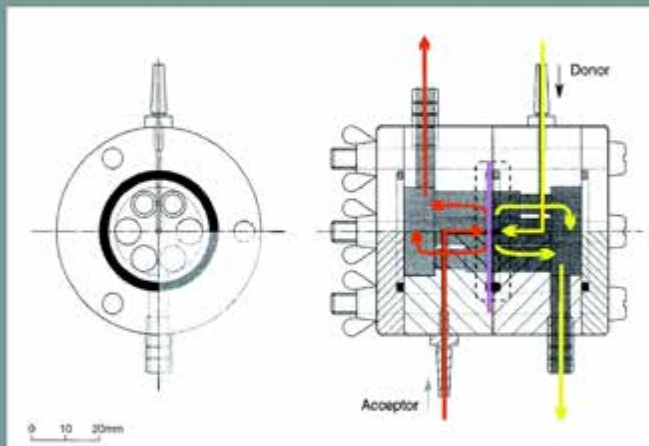

Donor = Sample solution

Acceptor = electrolyte with
same salt level as Donor

Membrane = semipermeable
negatively charged cation
exchange membrane

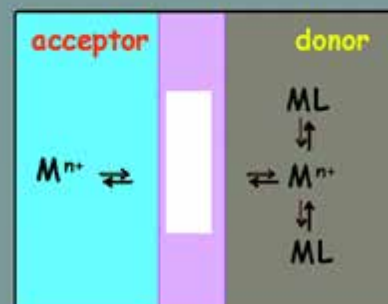

Colour Plates

31_Kuzyakov (p. 310)

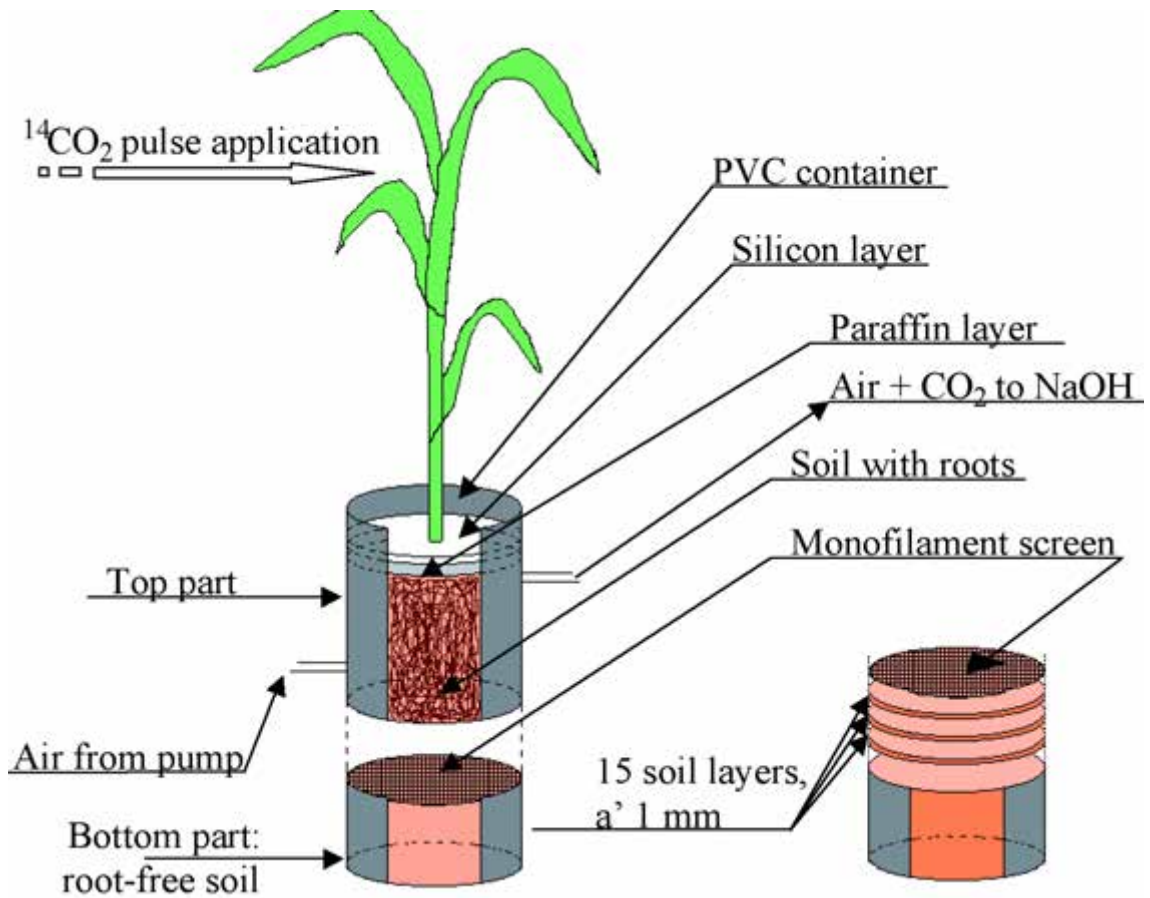

Fig. 1: Two-compartment pot for studying distribution of root-derived carbon as a function of root proximity and estimation of exudate diffusion (from Kuzyakov, Y.; Raskatov, A.V.; Kaupenjohann, M. 2003. Turnover and distribution of root exudates of *Zea mays*. Plant and Soil 254: 317-327; with kind permission of Springer Science and Business Media).

31_Morel (p. 313)



Fig. 1: Nodal roots covered with mucilage



Fig. 2 : Collection of mucilage

Colour Plates

31_Neumann_a (p. 316)

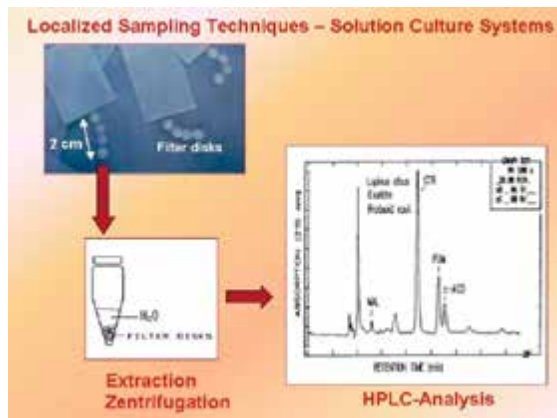

Fig. 1: Localized collection of root exudates from plants grown in hydroponics by application of filter paper with subsequent extraction and HPLC analysis

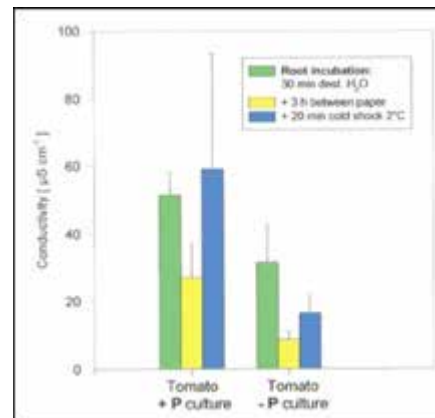
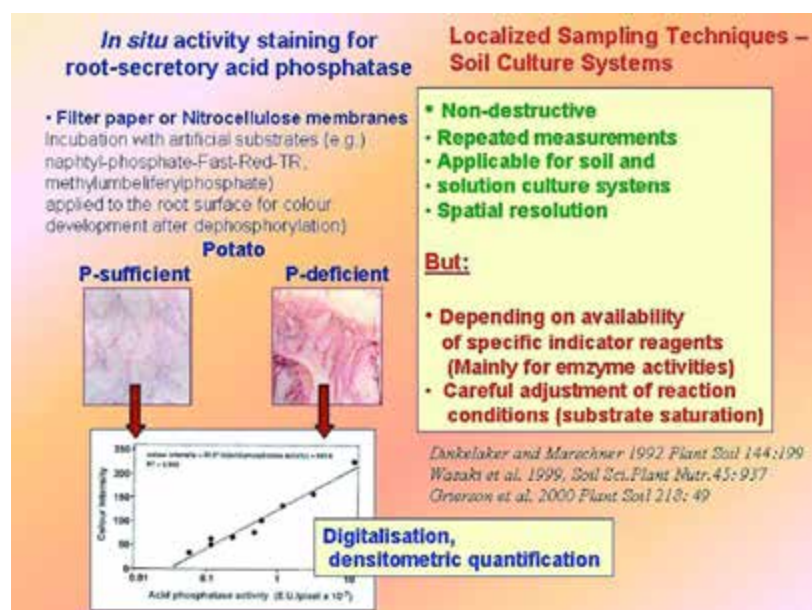

Fig. 2: Root injury was evaluated by measuring electrical conductivity of root washings before and after covering the root systems with filter paper. The conductivity was not increased by paper application, indicating that there was no mechanical damage of the roots. In contrast, cold-shock treatments (20 min 2°C) increased the conductivity by approximately 100 %, proving the sensitivity of the conductivity test.



Fig.3: Fluorescent phenolics released along the main root of cowpea seedlings. Collection by application of a nylon membrane onto the root surface.

Fig.4



Colour Plates

31_Neumann_b (p. 318)

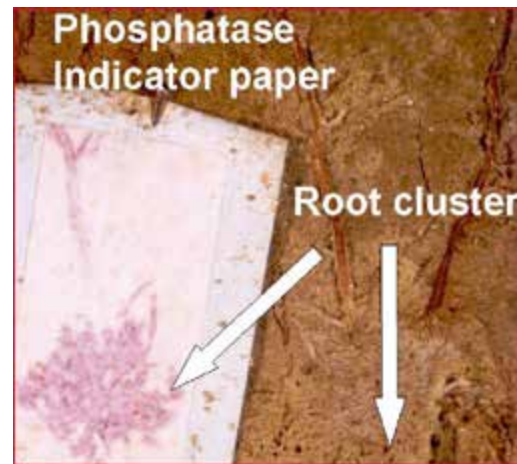
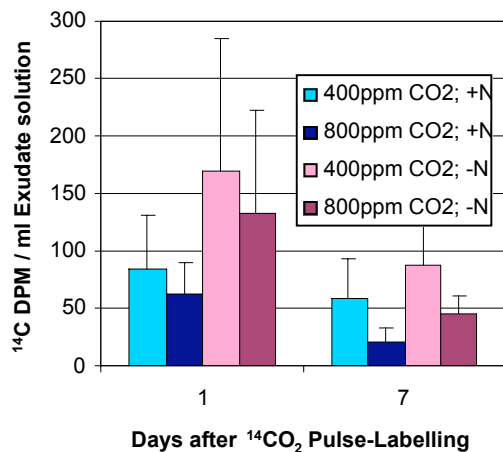
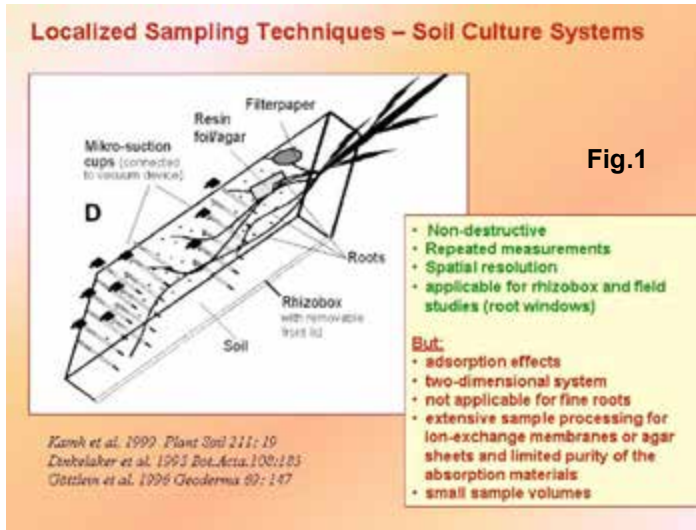

Fig. 2: Localized collection of ¹⁴C-labeled root exudates collected with paper discs (∅ 5 mm, see Fig.1) in 1 cm apical root zones after ¹⁴CO₂ shoot pulse-labelling of bean plants grown in rhizobox culture depending on N supply and atmospheric CO₂ concentration.

Fig.3: Detection of acid phosphatase activity with phosphatase indicator paper at the root surface of cluster roots of *Hakea undulata* in rhizobox culture.

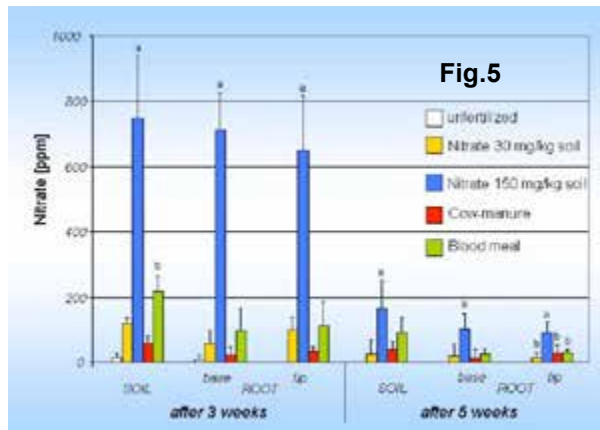

Fig.4: Fluorescent phenolics released from bean roots in rhizobox culture. Collection by 20-application of a nylon membrane onto the root surface.

Fig.5: Nitrate in soil solutions collected with paper discs (∅ 5 mm, see Fig.1) in a rhizobox culture system with apple seedlings supplied with different forms of N fertilization.

Colour Plates

31_Neumann_e (p. 324)

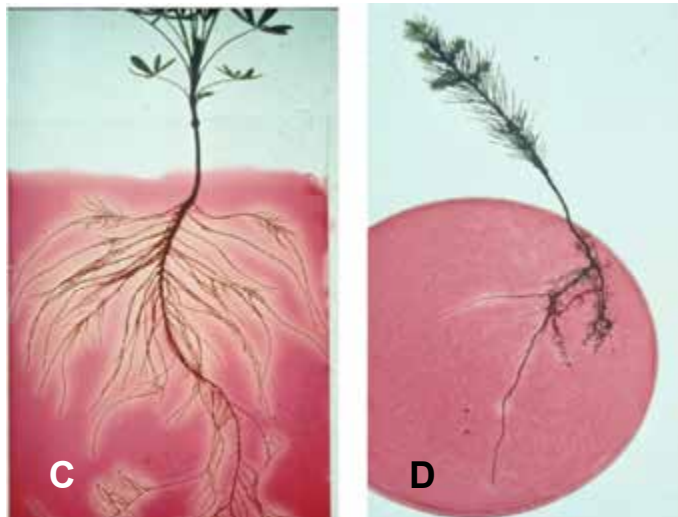
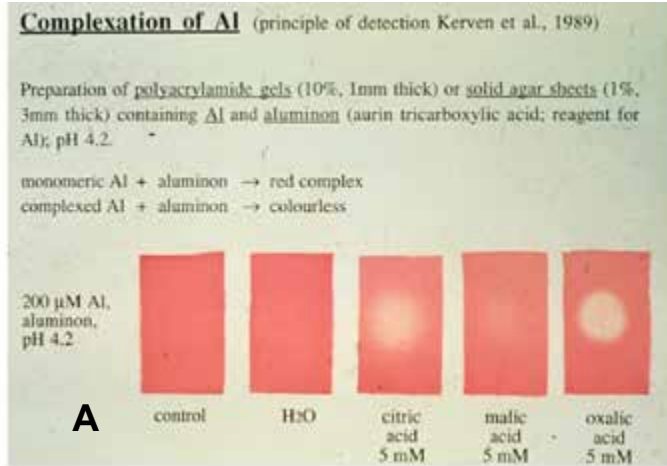

Fig. 1: Principle (A) and applications for *in situ* detection of Al complexation with the aluminon competition test: (B) Al-complexation along roots of Norway spruce in rhizobox culture. (C) Root-induced Al-complexation in seedlings of *Lupinus luteus* and (D) Norway spruce, grown in hydroponic culture.

31_Neumann_f (p. 325)

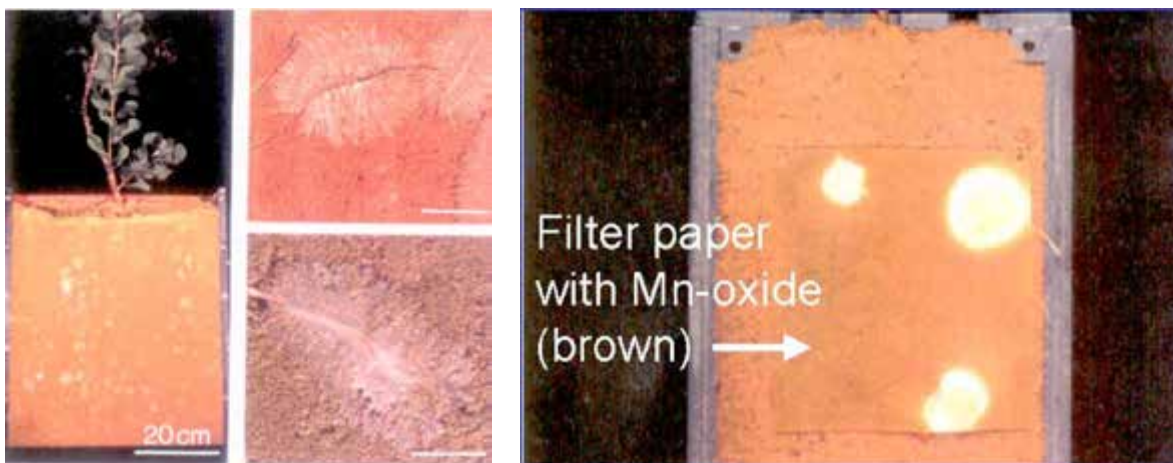

Fig. 1. Mn-reduction detected by decolouration of Mn-oxide impregnated filter paper in the rhizosphere of *Hakea undulata* (Proteaceae) grown in rhizobox culture on a P-deficient Arenosol from West Africa

Colour Plates

31_Neumann_g (p. 327)

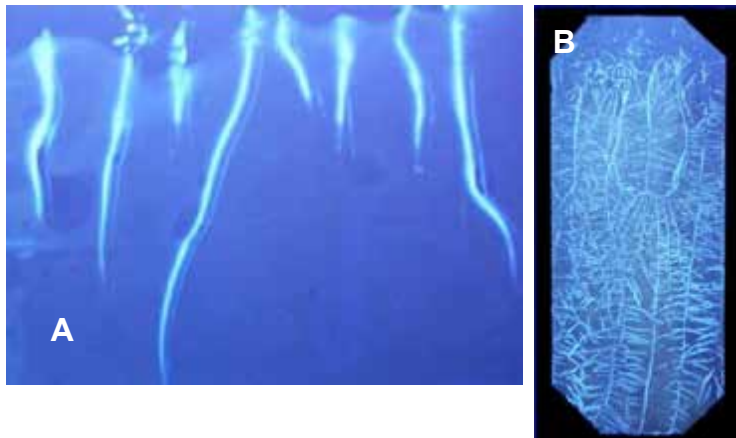

Fig.1: Fluorescent phenolics released along the main root of cowpea seedlings germinated in filter paper (A) and from roots of soil-cultured *Phaseolus vulgaris* in rhizoboxes (B). Collection by 20-application of a nylon membrane onto the root surface.

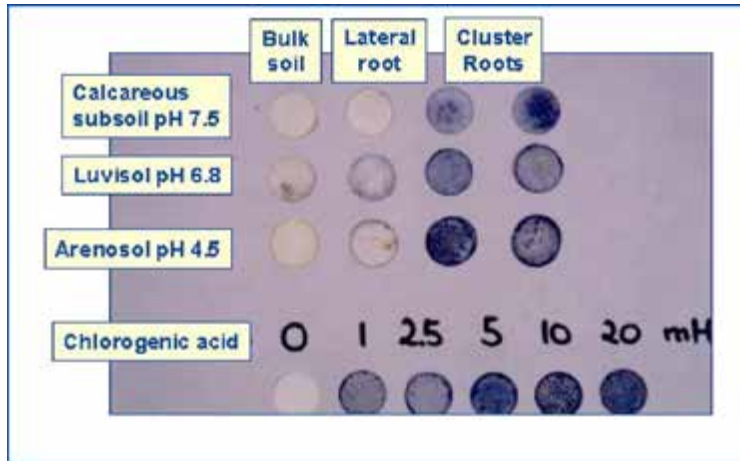
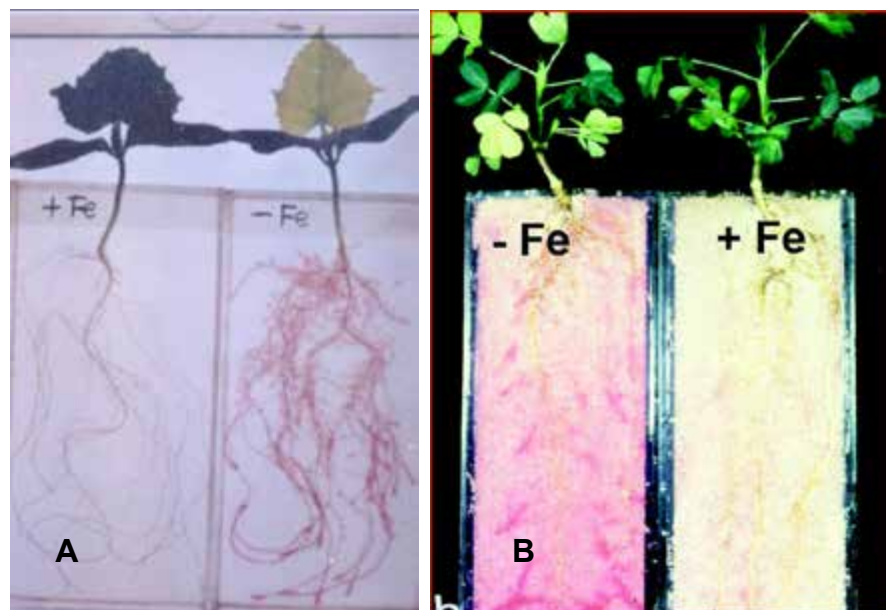

Fig. 2: Semi-quantitative detection of phenolics, released from roots of *Hakea undulata* in rhizobox culture. Collection by application of cellulose-acetate filters onto the root surface and subsequent detection with Folin reagent. Chlorogenic acid was used as a standard.

31_Neumann_i (p. 330)

Fig. 1: FeII reduction along roots of cucumber (A) grown in hydroponics and of peanut in rhizobox culture (B) with or without Fe supply. Detection by formation of red Fe^{2+} complexes with BPDS.



Colour Plates

31_Neumann_j (p. 332)

***In situ* activity staining for root-secretory acid phosphatase**

- Filter paper or Nitrocellulose membranes

Incubation with artificial substrates (e.g.) naphthyl-phosphate-Fast-Red-TR, methylumbeliferylphosphate) applied to the root surface for colour development after dephosphorylation)

Potato

P-sufficient **P-deficient**



- **Non-destructive**
- **Repeated measurements**
- **Applicable for soil and solution culture systems**
- **Spatial resolution**

But:

- **Depending on availability of specific indicator reagents (Mainly for enzyme activities)**
- **Careful adjustment of reaction conditions (substrate saturation)**

Dinkelaker and Marschner 1992 Plant Soil 144:199
Wazaki et al. 1999, Soil Sci.Plant Nutr.45: 937
Grierson et al. 2000 Plant Soil 218: 49

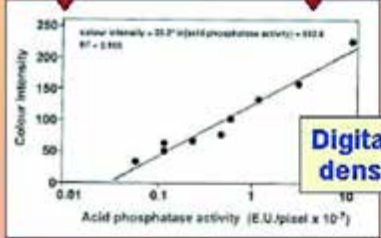

Digitallisation, densitometric quantification

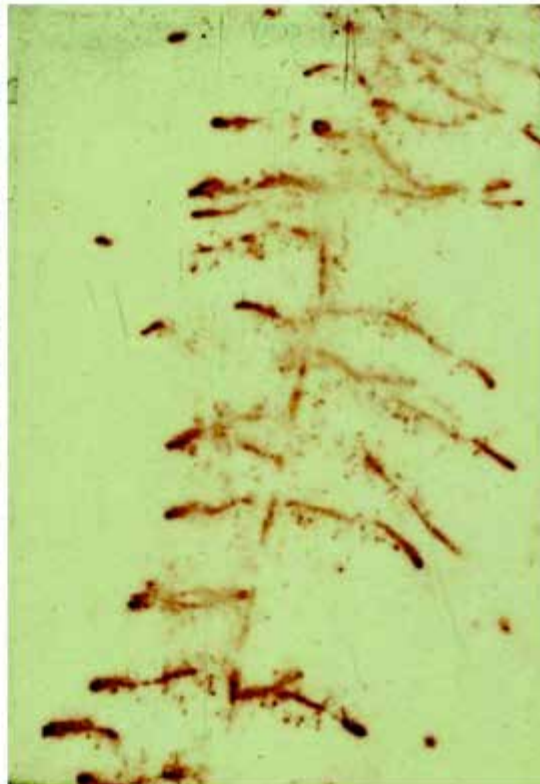

Acid phosphatase activity in the rhizosphere of soil-grown plants in rhizobox-culture by application of filter paper soaked with naphthyl-phosphate. Fast-Red TR substrate solution.

Colour Plates

32_Dennis (p. 337)

Fig 1. (right) Diagram of labelling setup.

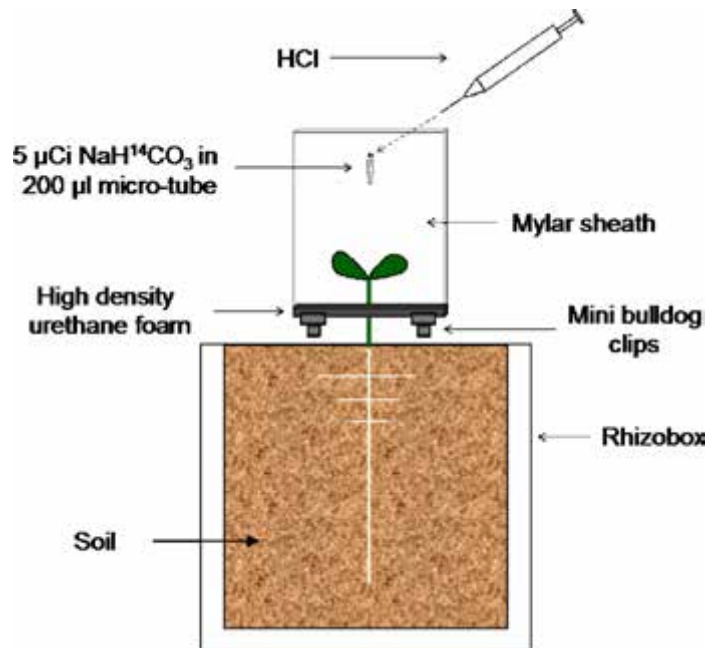
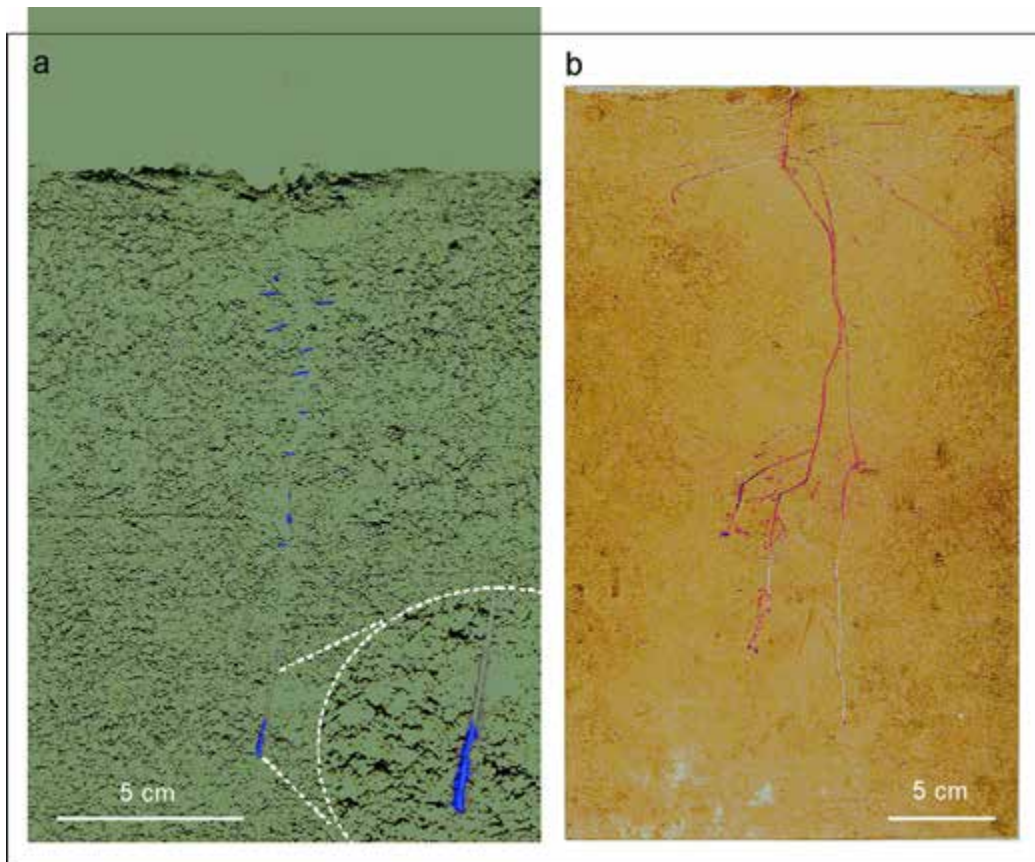

Fig 2. (below) (a) Carbon allocation in a 6 day old Brassica napus plant. Overlay image generated from a phosphor image and photograph (b) Carbon allocation pattern in a 32 day old B.napus plant.



Colour Plates

32_Finlay (p. 339)

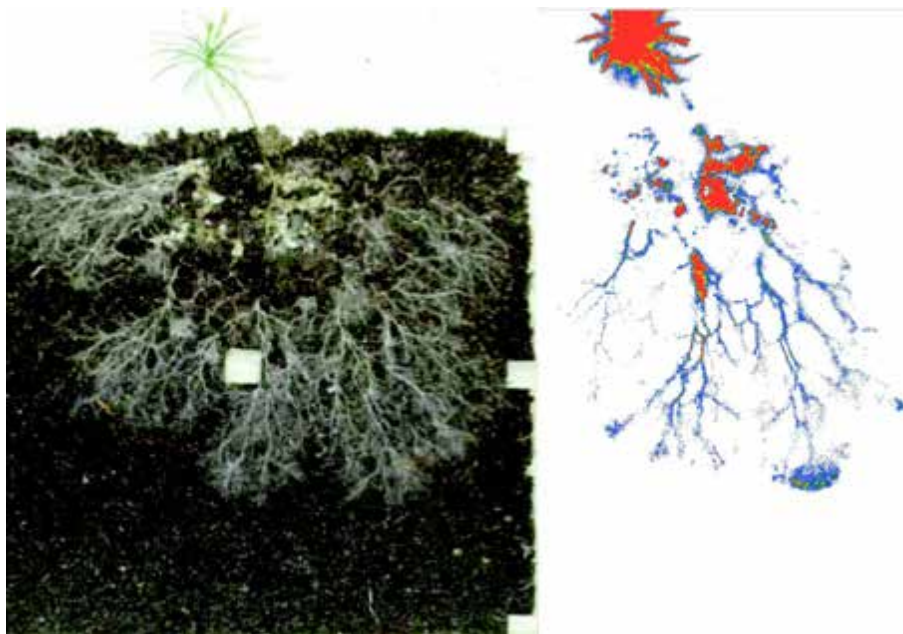
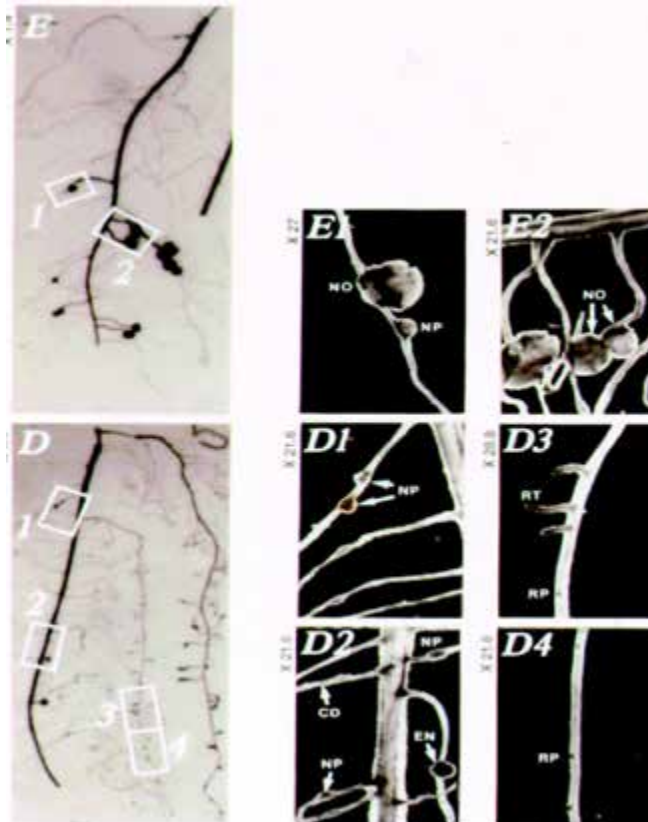

Fig. 1. scan of a microcosm containing a mycorrhizal pine seedling labelled with ^{14}C CO_2 . The distribution of carbon to the margin of the ectomycorrhizal mycelium is evident

32_Hacin (p. 342)

Figure 1. Autoradiographs and corresponding details on stained roots of the E-early and D- delayed inoculated split-root system of soybean. Abbreviations: NO – nodules, EN- emerging nodule, NP- nodule primordia, CD-cortical cell division centres, RP-root primordia, RT-root tips (from Hacin, J.; Bohlool, B.B.; Singleton, P.W. 1997. Partitioning of ^{14}C -labelled photosynthate to developing nodules and roots of soybean (*Glycine max*). *New Phytol.* 137: 257-265; reproduced with permission of the *New Phytologist* Trust).



Colour Plates

41_Blaschke (p. 381)

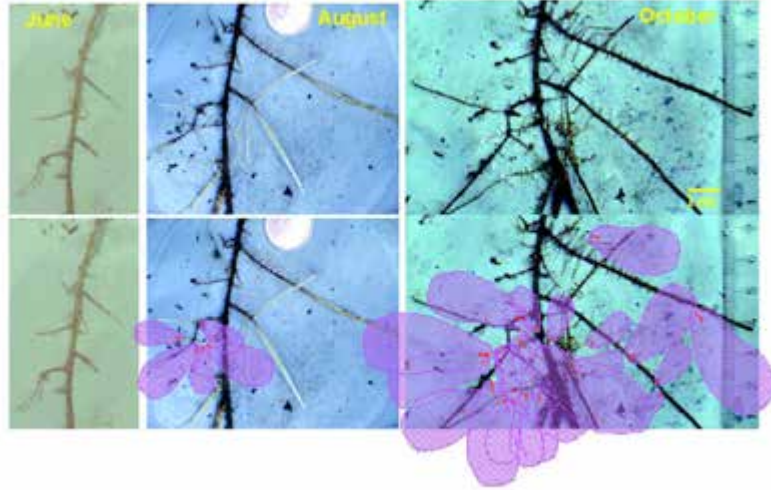
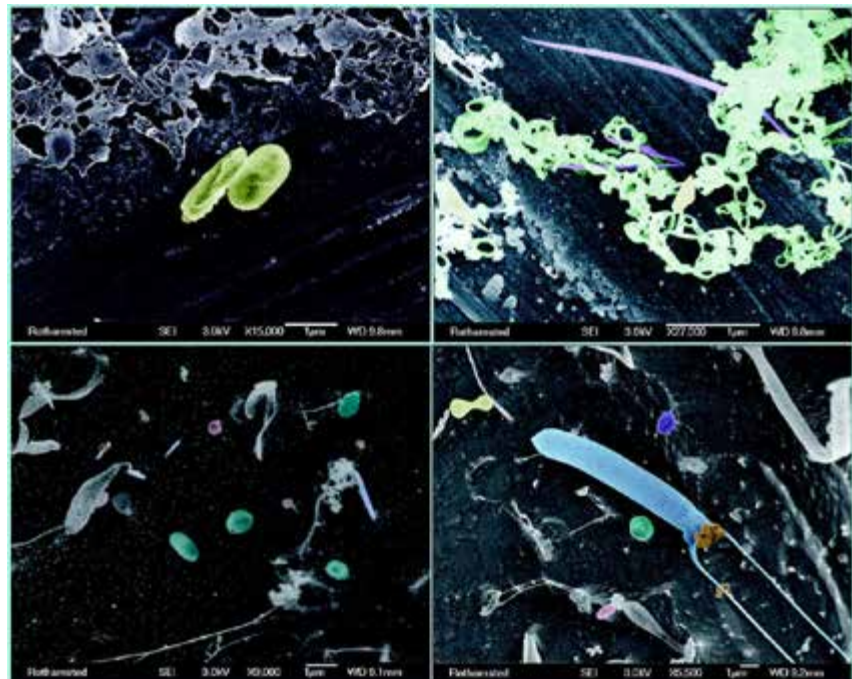

Fig. 1. Color images of individual fine root segments of Norway spruce used to determine establishment and growth dynamics of ectomycorrhiza inside TSSC frames (root screen 10x10cm). Individual frames of the resulting binary image of root segment (see **12_Nikolova**). Enlarged consecutive images of roots from time series are used for detailed examination of ectomycorrhizal colonization and formation of rhizomorphal connections, soil exploitation, and space sequestration in-between ramified mycorrhizal systems of *Xerocomus* spec. Bar length represents 10mm. (Nikolova and Blaschke 2002/2005, unpublished data).

41_Dennis_a (p. 385)

Fig. 3 False colour scanning electron micrographs of cryo-fixed, chromium coated microsample contents. Images demonstrate diverse range of sizes and morphologies of microorganisms. We thank Jean Devonshire (Rothamsted Research) for assistance.



Colour Plates

41_Dennis_b (p. 387)

Fig 1. Colonisation pattern of *P. fluorescens* SBW25 *luxCDABE* in the rhizosphere of a 4 day old *Brassica napus* root; (a) overlay (b) light field and (c) dark field.

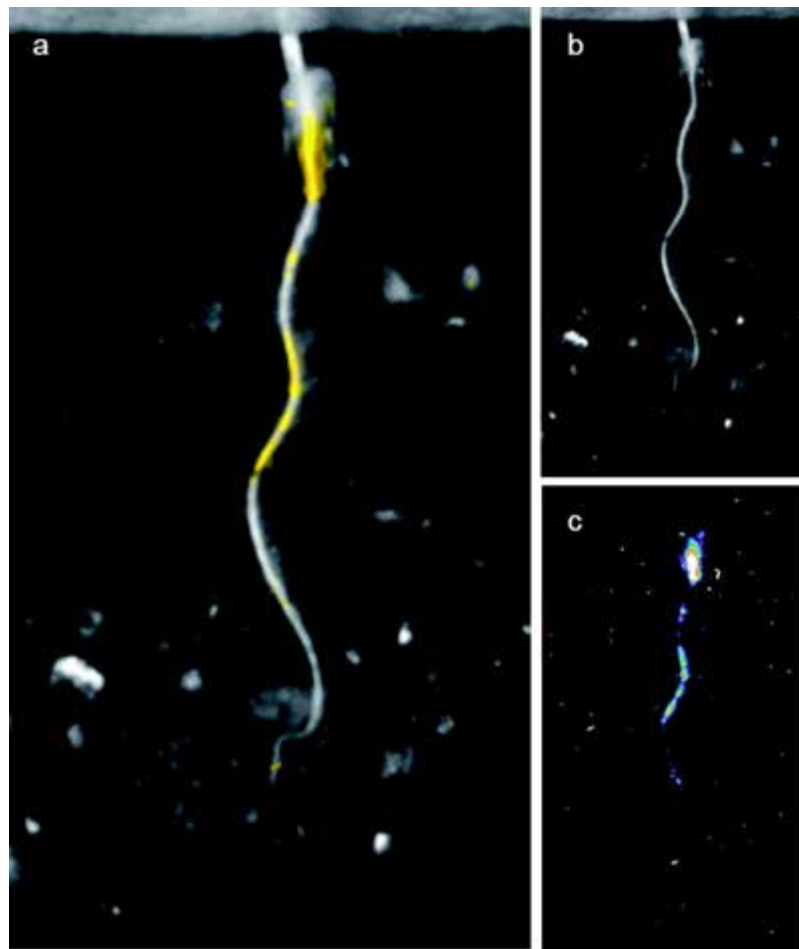

41_Rothballer (p. 404)

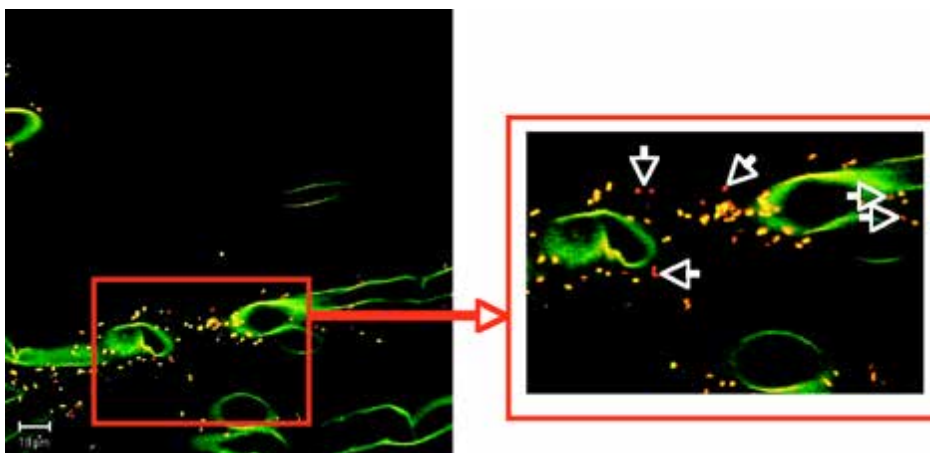

Fig. 1: Rhizosphere bacteria stained with DNA binding dye SYTO orange 81 on wheat roots; AHL production of *Acidovorax* sp. N35 (red cells) is indicated by *gfp* expression of the sensor strain *S. liquefaciens* MG44 (yellow cells: combination of GFP and red fluorescing SYTO dye), which contains the sensor construct pBAH9 (Huber, unpublished). Picture by Brigitte Hai