



HAL
open science

Identification of New Antimicrobial Peptides that Contribute to the Bactericidal Activity of Egg White against *Salmonella enterica* Serovar Enteritidis at 45 °C

Marie-Françoise Cochet, Florence Baron, Sylvie Bonnassie, Sophie Jan, Nadine Leconte, Julien Jardin, Valérie Briard-Bion, Michel Gautier, Simon C Andrews, Catherine Guérin-Dubiard, et al.

► To cite this version:

Marie-Françoise Cochet, Florence Baron, Sylvie Bonnassie, Sophie Jan, Nadine Leconte, et al.. Identification of New Antimicrobial Peptides that Contribute to the Bactericidal Activity of Egg White against *Salmonella enterica* Serovar Enteritidis at 45 °C. *Journal of Agricultural and Food Chemistry*, 2021, 10.1021/acs.jafc.0c06677 . hal-03142882

HAL Id: hal-03142882

<https://hal.inrae.fr/hal-03142882>

Submitted on 16 Feb 2021

HAL is a multi-disciplinary open access archive for the deposit and dissemination of scientific research documents, whether they are published or not. The documents may come from teaching and research institutions in France or abroad, or from public or private research centers.

L'archive ouverte pluridisciplinaire **HAL**, est destinée au dépôt et à la diffusion de documents scientifiques de niveau recherche, publiés ou non, émanant des établissements d'enseignement et de recherche français ou étrangers, des laboratoires publics ou privés.



Distributed under a Creative Commons Attribution - NonCommercial - NoDerivatives 4.0 International License

Identification of New Antimicrobial Peptides that Contribute to the Bactericidal Activity of Egg White against *Salmonella enterica* Serovar Enteritidis at 45 °C

Marie-Françoise Cochet,* Florence Baron, Sylvie Bonnassie, Sophie Jan, Nadine Leconte, Julien Jardin, Valérie Briard-Bion, Michel Gautier, Simon C. Andrews, Catherine Guérin-Dubiard, and Françoise Nau



Cite This: <https://dx.doi.org/10.1021/acs.jafc.0c06677>



Read Online

ACCESS |

Metrics & More

Article Recommendations

ABSTRACT: A recent work revealed that egg white (EW) at 45 °C exhibits powerful bactericidal activity against *S. enterica* serovar Enteritidis, which is surprisingly little affected by removal of the >10 kDa EW proteins. Here, we sought to identify the major EW factors responsible for this bactericidal activity by fractionating EW using ultrafiltration and nanofiltration and by characterizing the physicochemical and antimicrobial properties of the resulting fractions. In particular, 22 peptides were identified by nano-LC/MS-MS and the bactericidal activities of representative peptides (with predicted antimicrobial activity) were further assessed. Two peptides (FVPPVQR and GDPSAWSWGAEAHS) were found to be bactericidal against *S. enterica* serovar Enteritidis at 45 °C when provided in an EW environment. Nevertheless, these peptides contribute only part of this bactericidal activity, suggesting other, yet to be determined, antimicrobial factors.

KEYWORDS: egg white, ultrafiltration, antimicrobial activity, peptide, *Salmonella* Enteritidis

INTRODUCTION

Egg white (EW) represents a hostile medium for microorganisms due to its alkaline pH, high viscosity, nutrient deficiency, and the array of antimicrobial proteins and peptides it contains (in particular, lysozyme, ovotransferrin, protease inhibitors, and vitamin-binding proteins).^{1,2} Lysozyme exerts hydrolytic activity against the cell wall of Gram-positive bacteria leading to membrane disruption. Ovotransferrin is a high-affinity iron-chelating protein that promotes iron restriction and mediates damage to bacterial cytoplasmic membranes.³ Protease inhibitors (e.g., ovomucoid, ovoinhibitor, cystatin, and ovostatin) would inhibit proteases of pathogenic bacteria required for host colonization. EW vitamin-binding proteins, namely, flavoprotein, avidin, and the thiamine-binding protein sequester riboflavin, biotin, and thiamine, respectively, and thus would induce a bacteriostatic effect. In addition, some minor proteins and peptides recently revealed by high-throughput approaches may also play a role in defense against bacterial contamination, and it is quite possible that the various antibacterial factors associated with EW interact synergistically to enhance protection against bacterial invaders.⁴

Previous studies on the antimicrobial activity of chicken EW largely focused on *Salmonella enterica* serovar Enteritidis, hereinafter referred to as *S. Enteritidis*, since this serotype is the major food-borne pathogen (90%) associated with the consumption of eggs and egg products.⁵ The high association of *S. Enteritidis* in egg-related salmonellosis is thought to be due to its specialized ability to survive exposure to the hostile conditions of EW.^{6–8} It is generally accepted that upon

exposure to EW *Salmonella* suffers from two major harmful influences, iron deficiency (resulting in a bacteriostatic effect) and cell-envelop damage (which is bactericidal).⁴ However, physicochemical factors, such as alkaline pH and temperature of incubation, also play important roles in EW antimicrobial activity. Indeed, *S. Enteritidis* is able to grow weakly in EW at 20 °C and 30 °C.^{2,9} However, at higher temperatures (≥42 °C), EW exerts a bactericidal effect against *S. Enteritidis*.^{1,6,10}

It is notable that the lowest temperature at which significant bactericidal activity is observed for EW is close to that naturally encountered during egg formation (i.e., that of the hen body, 42 °C). For this reason, this temperature is routinely used in studies on the bactericidal activity of EW.^{11,12} The importance of temperature in the antimicrobial activity of EW is highlighted by a method for pasteurization of liquid EW involving heat treatment at 42–45 °C for 1–5 days. This treatment allows subsequent storage of EW at room temperature for several months,¹³ and critically, it results in a complete killing of *S. Enteritidis* and is more efficient than the traditional EW pasteurization treatment (57 °C for 2–5 min) that requires subsequent storage under refrigeration.

Exposure of *S. Enteritidis* to EW model medium (namely, egg white 10 kDa filtrate supplemented with 10% EW) at 45

Received: October 21, 2020

Revised: January 21, 2021

Accepted: January 27, 2021

°C for 45 min results in extensive changes in global gene expression¹⁰ indicative of a major response of *S. Enteritidis* to nutrient deprivation (iron and biotin) and cell damage/stress, and a shift in energy metabolism and catabolism. These changes were considered to reflect attempts by *S. Enteritidis* to overcome the antibacterial activities of EW that lead to eventual cell death after prolonged incubation at 45 °C. Surprisingly, removal of the ≥ 10 kDa proteins from EW by ultrafiltration had little impact on the global expression pattern (only 64 genes were affected after 45 min, 2% of the total genome) and the bactericidal activity (over 24 h) compared to the EW model medium, indicating that the EW proteins of ≥ 10 kDa are not strictly required for the bactericidal activity of EW at 45 °C,¹⁴ despite potentially active. In addition, the ≥ 10 kDa proteins of EW were not required for lysis of *S. Enteritidis* in EW at 45 °C.¹⁴ Thus, it was concluded that low-mass (<10 kDa) components of EW (such as minerals and/or small bioactive/antimicrobial peptides) are probably the major contributors to the bactericidal activity of EW at 45 °C.¹⁴

The aim of this study was to determine the key low-mass (<10 kDa) factors responsible for *Salmonella* killing by EW at 45 °C. To identify such factors, successive ultra- and nanofiltration steps were applied to EW (10 kDa, 1 kDa, and 400 Da cutoff membranes, respectively) and the antimicrobial activities and compositions of the resulting filtrates were determined.

MATERIALS AND METHODS

Bacterial Strain. *S. enterica* serovar Enteritidis NCTC13349 was kindly provided by Matthew McCusker (Center for Food Safety and Food Borne Zoonomics, Veterinary Sciences Centre, University College Dublin, Ireland). This strain was isolated from an outbreak of human food poisoning in the United Kingdom traced back to a poultry farm. The stock cultures were stored at -80 °C in 25% (v/v) glycerol. Before use, the cells were propagated twice overnight at 37 °C in tryptic soy broth (TSB, Merck, Darmstadt, Germany) without shaking.

Preparation of Sterile Egg White. EW was prepared from 5- to 10-day-old eggs provided from a local supermarket. The eggshell surface was cleaned with a tissue, checked for cracks, and then sterilized using 70% alcohol; residual alcohol was removed by briefly flaming the shell. Eggshells were then broken under sterile conditions, and the egg whites were collected before aseptic homogenization with a D125 Basic homogenizer (Ika, Grosseron, Saint-Herblain, France) at 9500 rpm for 1 min. The egg white pH was 9.3 ± 0.1 .

Egg White Fractionation. EW ultrafiltration was carried out according to Baron et al.² using a pilot unit (Millipore type PRO LAB MSP 006239) equipped with an organic spiral-wound membrane (0.3 m², 10 kDa cutoff). The concentrated EW (egg white retentate, EWR) was circulated back to the feed-tank while the EW filtrate (10 kDa EWF) was drained off and collected in a beaker (Figure 1). The 10 kDa EWF was then either subjected to ultrafiltration (as above) using an organic spiral-wound membrane (0.3 m², 1 kDa cutoff) to obtain the 1 kDa EWF, or to nanofiltration with a Helicon Nanomax 50 membrane (0.3 m², 400 Da cutoff) to obtain the 400 Da EWF (Figure 1). All EW filtrates (EWF) were sterilized by filtration (NalgeneR filter unit, pore size <0.2 μ m, Osi, Elancourt, France), measured for pH and then stored at 4 °C until use.

Physicochemical Analyses. The nitrogen content of EW and EWFs was determined by the Kjeldahl method. Glucose was quantified using an enzymatic spectrophotometric test (Glucose GOD FS) according to the instructions of the provider (DiaSys GmbH, Germany). Mineral quantification by ICP-OES was carried out using samples in 10% iron-free nitric acid (Sigma-Aldrich; 438073), incubated in sealed, plastic tubes at 80 °C overnight with occasional vortexing. The samples were centrifuged (4 °C, 30 min, 18 111g), and the supernatants were diluted twofold. The multi-

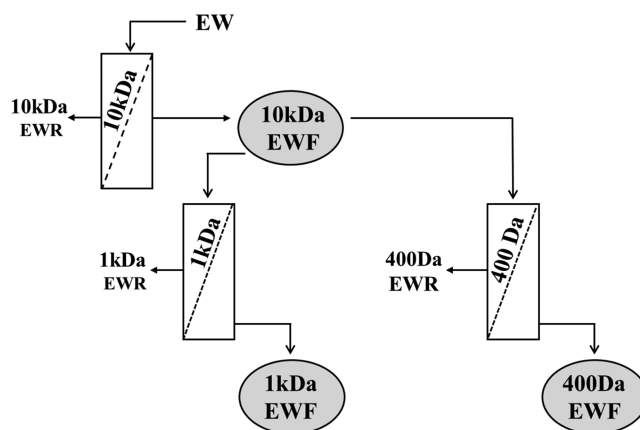

Figure 1. Flowchart of egg white (EW) fractionation by ultrafiltration and nanofiltration for the preparation of the 10 kDa, 1 kDa, and 400 Da egg white filtrates (EWFs). Egg white retentates (EWRs) are the fractions retained by the membranes.

elemental contents of the nitric-acid-dissolved sample solutions were determined using a PerkinElmer Optima 3000 ICP-OES with radial view and a crossflow nebulizer (Anne Dudley, Analytical Technical Services, University of Reading).

Mass Spectrometry Analysis. Mass spectrometry (MS) analysis was performed on EW fractions (10 kDa EWF, 400 Da EWF, and 400 Da EWR) using a NanoLC Dionex U3000 system fitted to a Q Exactive mass spectrometer (Thermo Scientific, San Jose) equipped with a nano-electrospray ion source. The samples (100 μ L) were diluted in a solution composed of 100 μ L of nano-LC solvent A described below and 50 μ L of 2% formic acid. These samples were concentrated on a C18 PepMap100 cartridge (5 μ m particle size, 100 Å pore size, 300 μ m i.d., 5 mm length; Dionex, Amsterdam, The Netherlands), before peptide separation on a C18 PepMap100 column (3 μ m particle size, 100 Å pore size, 75 μ m i.d., 150 mm length; Dionex). Elution was performed using solvent A (2% v/v acetonitrile, 0.08% v/v formic acid and 0.01% v/v TFA in deionized water) and solvent B (95% v/v acetonitrile, 0.08% v/v formic acid, and 0.01% v/v TFA in deionized water) by applying a gradient from 5 to 70% solvent B over 28 min followed by a gradient from 70 to 95% solvent B over 5 min at a flow rate of 0.3 mL/min.

Eluted peptides were directly electrosprayed into the Proxeon source operating in positive-ion mode with an optimized voltage of 2.1 kV. The mass spectra were recorded in an m/z range from 250 to 2000, with a resolution of the mass analyzer set to 70 000. For each scan, the 10 most intense ions were selected for fragmentation. MS/MS spectra were recorded with a resolution set to 17 500, with exclusion from MS/MS fragmentation of the parent ion for 15 s. The equipment was externally calibrated according to the supplier's instructions. All samples were analyzed in triplicate.

Identification of Peptides. Peptides were identified from the MS/MS spectra using X!Tandem pipeline software (Plateforme d'Analyse Protéomique de Paris Sud-Ouest (PAPPSO), INRAE, Jouy-en-Josas, France; <http://pappso.inra.fr>). The search was performed against a database composed of reviewed proteins of *Gallus gallus* (2262 proteins downloaded to which was added the common Repository of adventitious Protein; <http://thegpm.org/crap>). Database search parameters were specified as follows: nonspecific enzyme cleavage; a 0.05 Da mass error for fragment ions; 10 ppm mass error for parent ions; with methionine oxidation and serine phosphorylation as putative modifications. A minimum score corresponding to an e -value below 0.05 was required for valid peptide identification.

Prediction of Antimicrobial Activity of Peptides. According to an approach previously described by Bishop et al.,¹⁵ the peptide sequences identified in the EW fractions were submitted to the free web-based ADAM database¹⁶ using SVM Predict (Support Vector Machine) (http://bioinformatics.cs.ntou.edu.tw/ADAM/svm_predict.php) or to the cAMP database using SVM, random forest

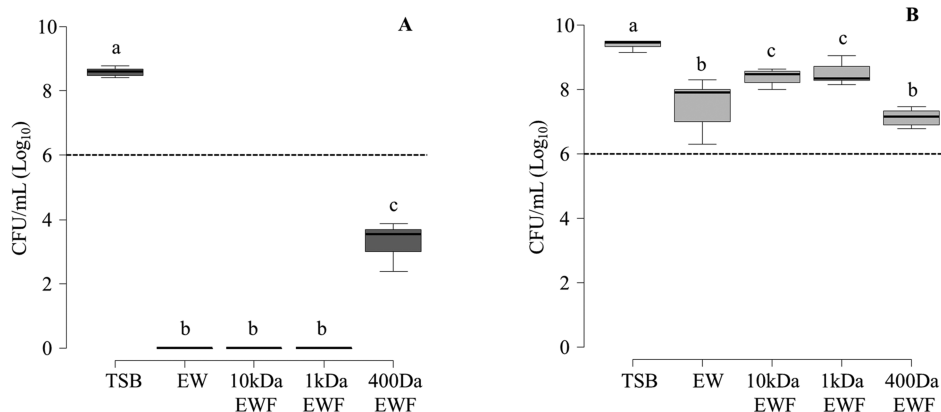

Figure 2. *S. Enteritidis* numeration after incubation for 24 h at 45 °C (A) and 30 °C (B) in TSB pH 7.3, egg white (EW) and 10 kDa, 1 kDa, and 400 Da egg white filtrates (EWFs). Bacteria were initially inoculated at 10⁶ CFU/mL (dotted line). Means and standard deviations were calculated from nine replicates (three biological replicates, each with three technical replicates). Samples with different letters display significantly different mean values ($p < 0.0001$ in (A), $p < 0.001$ in (B)).

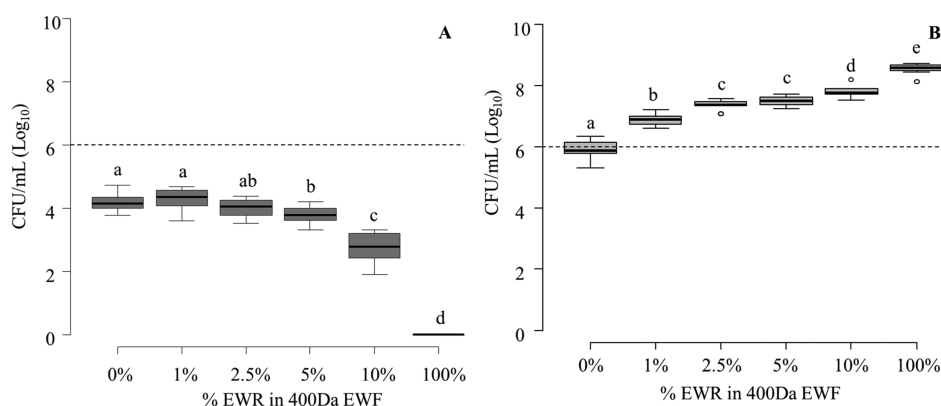

Figure 3. *S. Enteritidis* survival after incubation for 24 h at 45 °C (A) and 30 °C (B) in 400 Da egg white filtrate (EWF) supplemented with increasing levels of the 400 Da egg white retentate (EWR). Bacteria were initially inoculated at 10⁶ CFU/mL (dotted line). Means and standard deviations were calculated from nine replicates (three biological replicates, each with three technical replicates). Samples with different letters display significantly different mean values ($p < 0.001$).

(RF), artificial neural network (ANN), and discriminant analysis (DA) (<http://www.camp.bicnirrh.res.in/predict/hii.php>). Several physicochemical characteristics of these peptides were also calculated using ProtParam tools (ExPASy Bioinformatics Resource Portal): theoretical molecular weight, theoretical pI, hydrophobicity evaluated by the GRAVY index (Grand Average Hydropathy value), and stability evaluated by the instability index. The net charge at pH 7.0 and 9.0 was predicted using the Protein Calculator v3.4 (<https://protcalc.sourceforge.net/cgi-bin/protcalc>). Comments about structure features were extracted from the Antimicrobial Peptide Calculator and Predictor APD3 (<http://aps.unmc.edu/AP/prediction/actionInput.php>).

Peptide Synthesis. The peptides P1=VFPVQQR, P2=GDPASAWSWGAEAS, P3=TPPFGGFR, and P4=HPFIQHPVHG were synthesized by Eurogentec (Angers, France) at purity rates above 95%. Stock solutions were prepared by dissolving each synthetic peptide in sterile ultrapure water at 2 mg/mL and stored at −20 °C until use.

Anti-Salmonella Activity Measurement. The anti-*Salmonella* activity of EW, EWFs, and isolated EW peptides was determined by incubation with *Salmonella* for 24 h at 45 and 30 °C (as a control temperature) as follows. After overnight propagation in tryptone soy broth (TSB, pH 7.3, Merck, Darmstadt, Germany), *Salmonella* cultures were centrifuged (5600g at 15 °C for 7 min) and the cells were washed three times in the same volume of tryptone salt medium (AES, Combourg, France) or TSB (when TSB was used as the assay medium). The washed pellets were finally resuspended in the same

volume of tryptone salt medium and diluted to inoculate at 2% 96-well microplates 2.2 mL (Starlab, Bagneux, France) containing 800 μL of the assay medium to obtain a final *Salmonella* inoculum level of 6 ± 0.2 log₁₀ CFU/mL.

To test the antibacterial activity of the peptides of interest, assay medium with synthetic P1, P2, P3, or P4 peptides (100 μg/mL) in either 400 Da EWF or minimal medium M63 (60 mM KH₂PO₄, 1.5 mM (NH₄)₂SO₄, 1 mM MgSO₄, 0.4% glucose) was used; pH was adjusted to 9.2 with KOH 30%.

To test the effect of pH and nutritional deficiency, the pH of the 400 Da EWF was adjusted to 9.2 with 2 M NaOH, and glucose and NH₄Cl were added to final concentrations of 25 and 3 mM, respectively.

After incubation for 24 h at 30 °C, viable cell numbers were determined using a numeration method based on the miniaturization of the conventional plate-counting technique, according to Baron et al.¹⁷ with a Tryptone soya agar (TSA) (Merck, Darmstadt, Germany) overlay procedure. Results were compared using analysis of variance and the average comparison test using the R 2.13.0 software (<http://cran.r-project.org>).

RESULTS AND DISCUSSION

Removal of Components >400 Da Significantly Reduces but Does Not Eliminate the Bactericidal Activity of EW against *S. Enteritidis* at 45 °C. The approach adopted to investigate the key factors responsible for the bactericidal effect of EW and EWFs on *S. Enteritidis* at

45 °C was based on an EW fractionation strategy using successive ultrafiltration and nanofiltration steps (10 kDa, 1 kDa, and 400 Da cutoff, respectively) followed by assessment of *S. Enteritidis* survival at 45 °C (and 30 °C as a control) in EW and in the three resulting fractions: 10, 1, and 400 Da EWF.

A strong bactericidal effect was observed after 24 h at 45 °C in all EW fractions: *Salmonella* cells were undetectable in EW, 10 kDa EWF and 1 kDa EWF, which corresponds to a 6 log₁₀ reduction in cell numbers. However, *S. Enteritidis* only decreased by 2.6 ± 0.5 log₁₀ in the 400 Da EWF (Figure 2A). The bactericidal effect observed was not simply due to temperature as there was an increase of 2.6 ± 0.2 log₁₀ CFU/mL after 24 h when incubation at 45 °C was performed in TSB rather than EW or the EWFs. However, the bactericidal effect was only observed for EW and EWFs at 45 °C; at 30 °C, the *Salmonella* cells count increased in all of the media tested (Figure 2B). Nevertheless, the growth at 30 °C was significantly lower in EW and EWFs (+1.5 ± 0.7 log₁₀ CFU/mL in EW; +2.4 ± 0.2 log₁₀ CFU/mL in 10 kDa and 1 kDa EWF; and +1.1 ± 0.2 log₁₀ CFU/mL in 400 Da EWF) than in TSB medium (+3.4 ± 0.1 log₁₀ CFU/mL). The above results are in agreement with those previously obtained in EW and 10 kDa EWF at 30 °C² and 45 °C,^{10,14} and they indicate that EW and the EWFs allow significant growth of *S. Enteritidis* at 30 °C, but become strongly bactericidal at 45 °C, unlike standard growth medium. Importantly, the bactericidal activity toward *S. Enteritidis* at 45 °C was significantly reduced for the 400 Da EWF, suggesting that EW factors larger than 400 Da play a major role in the bactericidal activity of EW at this temperature.

To confirm the differences in the bactericidal activity of the 400 Da EWF and the other EW fractions, *S. Enteritidis* survival was measured at 45 °C (and 30 °C as a control) in the 400 Da EWF with the addition of the 400 Da EWR at 0–100% (v/v) concentration (Figure 3). A clear dose-dependent response was observed, with a progressive increase in bactericidal activity at 45 °C achieved as the percentage of 400 Da EWR was elevated, with the activity reaching a maximum 6 log₁₀ reduction with 100% (v/v) 400 Da EWR (Figure 3A), as was obtained for the 1 kDa and 10 kDa EWFs (Figure 2A). Addition of the 400 Da EWR to the 400 Da EWF also restored the growth of *S. Enteritidis* at 30 °C (Figure 3B) such that the same level of growth was seen as that obtained for the 1 kDa or 10 kDa EWFs (Figure 2B). This indicates that the 400 Da EWR provides a source of nutrients for *S. Enteritidis* growth at 30 °C, but contributes to the antibacterial activity observed at 45 °C. In summary, the above data indicate that the bactericidal components of EW can be separated into two fractions on the basis of mass (> and <400 Da) and that recombining these fractions restores the bactericidal activity obtained at 45 °C to match that seen for whole EW. The results therefore support that the bactericidal activity of EW at 45 °C is a multifactorial phenomenon¹ and suggest it may result from the combination of physicochemical factors and small molecules (<10 kDa and >400 Da) such as antimicrobial peptides.

Contribution of Physicochemical Factors to the Bactericidal Activity of EW at 45 °C. Chemical analysis of EW and the 10 kDa and 400 Da EWFs was performed (Table 1) to determine whether there are any differences that could explain the reduced bactericidal activity seen for the 400 Da EWF. The glucose (180 Da) concentration in EW and

Table 1. Main Physicochemical Characteristics of 10 kDa and 400 Da Egg White Filtrates (EWF) and of Egg White (EW)

	EW	10 kDa EWF	400 Da EWF
pH	9.3	9.2	8.7
glucose (mM)	25	21.5	4.8
total N (mM)	1364	2.3	0.69
Na (mM)	67.4–80.9 ^a	96.1	62.7
K (mM)	35.8–44.2 ^a	44.7	28.7
Ca (mM)	1.2–2.9 ^a	0.96	0.24
Iron (mM)	0.003–0.018 ^a	<0.00002	0.00044
Mg (mM)	3.7–4.9 ^a	3.32	0.92
Zn (mM)	0.005–0.018 ^a	0.0005	0.001
Cu (mM)	0.003–0.006 ^a	0.00098	0.00072
Mn (mM)	0.001–0.002 ^a	<4.18 e ⁶	<4.18 e ⁻⁶

^aData from the Literature.^{53–57}

10 kDa EWF (21 and 25 mM, respectively) was approximately 2-fold higher than that typically used in culture media (around 11 mM glucose); a similar glucose concentration (17 mM) was also measured in 1 kDa EWF (data not shown). This suggests that there is sufficient glucose in EW but also in 10 kDa EWF and 1 kDa EWF to support *S. Enteritidis* growth. However, it is possible that the 4- to 5-fold lower level of glucose (4.8 mM) in the 400 Da EWF might contribute to the lower growth observed at 30 °C in 400 Da EWF in comparison to 10 kDa EWF (+1.1 ± 0.2 log₁₀ CFU/mL and +2.4 ± 0.2 log₁₀ CFU/mL, respectively). However, it is unlikely that this difference in glucose content is responsible for the reduced bactericidal activity of the 400 Da EWF at 45 °C.

The total nitrogen concentration was much higher in EW (1364 mM) than in the 10 kDa and 400 Da EWFs (2.3 and 0.69 mM, respectively), which is consistent with the high level of protein (around 10% w/v) in EW and the loss of protein from the EWFs through filtration (Table 1); the nitrogen content in 1 kDa EWF (2.1 mM) was similar to that measured in 10 kDa EWF (data not shown). The low nitrogen concentration of 400 Da EWF is close to the threshold concentration (1 mM) for enterobacteria growth.¹⁸ As for glucose, this relatively low nitrogen availability could contribute to the lower growth of *S. Enteritidis* at 30 °C in the 400 Da EWF compared to the 10 kDa EWF, as suggested by Figure 4. However, it is unlikely that this low protein content is responsible for the reduced bactericidal activity of 400 Da EWF at 45 °C. As for the lower growth at 30 °C in EW in comparison to 10 kDa EWF and 1 kDa EWF, it was likely due to the presence of antimicrobial proteins in EW.⁴

For the eight major minerals presented in Table 1, some differences were found between EW and the EWFs. In particular, there were major decreases in iron and manganese, and modest decreases for zinc, copper, calcium, potassium, and magnesium in the EWFs compared to EW (7.5–900, 250–500, 5–36, 3–9, 5–12, 0.98–1.25, and 1.11–4 times, respectively; Table 1). However, except for iron, the measured mineral concentrations are above the concentration thresholds considered necessary for bacterial growth.^{19–24} EW is well recognized as an iron-deficient medium, and it is generally considered that in whole EW, iron is almost entirely bound to ovotransferrin⁴ which would be lost upon filtration; this explains why the 10 kDa and 400 Da EWFs (both ovotransferrin-free) contain up to 900-fold less iron than EW. The reduced Zn, Cu, and (particularly) Mn in the EWFs

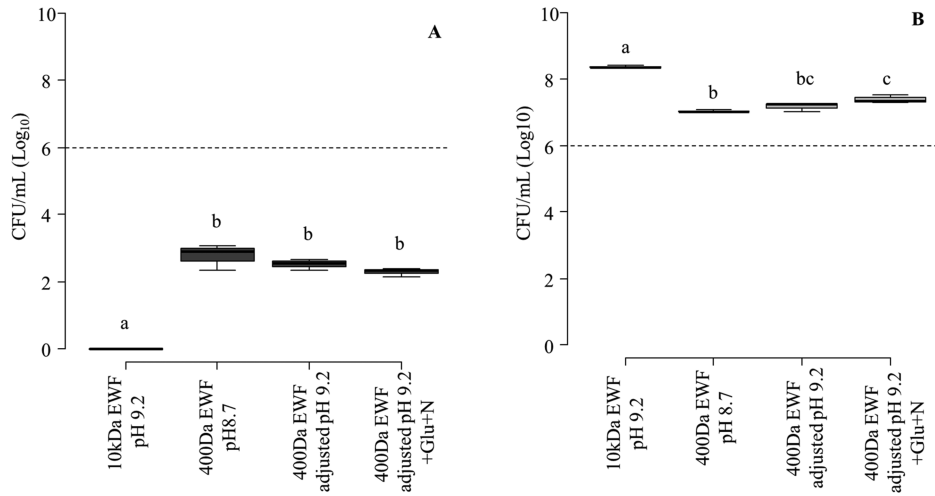

Figure 4. Effect of pH, glucose, and nitrogen levels on *S. Enteritidis* survival in the 400 Da EWF. *S. Enteritidis* was incubated for 24 h at 45 °C (A) or 30 °C (B) in 10 kDa EWF at pH 9.2, in 400 Da EWF at pHs 8.7 and 9.2, in 400 Da EWF at pH 9.2 and with addition of a nitrogen (N) source and glucose (Glu) (up to 3 mM N and 25 mM glucose). Bacteria were initially inoculated at 10⁶ CFU/mL (dotted line). Means and standard deviations were calculated from three technical replicates. Samples with different letters display significantly different mean values (*p* < 0.01).

Table 2. Sequences of the Peptides Identified in 10 kDa EWF, 400 Da EWR, and 400 Da EWF, Divided into Five Groups based on the Shortest Common Sequence^a

GROUPS	PEPTIDES	presence in		cAMP Prediction Score				Fragment	ORIGIN	Physicochemical characteristics									
		10kDa EWF	400Da EWR	ADAM Score	SVM	RF	ANN			DA	Experimental MW	Theoretical MW	pI	Net charge at pH7	Net charge at pH9	GRAVY	Instability index	Comments	
1	A F V P P V Q R	X	X	-	AMP 1.66	NAMP 0.057	NAMP 0.354	AMP	NAMP 0.020	212-219	clusterin precursor (NP_990231.1)	913.09	913.52	9.79	0.9	0.1	0.225	rich in P	
	A F V P P V Q R V	-	X	-	AMP 1.46	NAMP 0.139	NAMP 0.450	AMP	NAMP 0.064	212-220		1012.22	1012.59	9.79	0.9	0.1	0.667	putative helix	
	E A F V P P V Q R	X	X	-	AMP 0.99	NAMP 0.088	NAMP 0.277	NAMP	NAMP 0.001	211-219		1042.20	1042.57	6.10	-0.1	-0.9	-0.189	putative helix	
	E A F V P P V Q R V R	X	X	-	AMP 0.65	NAMP 0.013	NAMP 0.165	NAMP	NAMP 0.080	211-221		1297.53	1297.74	9.70	0.9	0.1	-0.182	putative helix	
	F V P P V Q R = P1	X	X	-	AMP 2.07	NAMP 0.000	NAMP 0.363	AMP	NAMP 0.012	213-219		842.01	842.49	9.75	0.9	0.1	0.000	91.11 unstable	rich in P
2	D P S A W S W G A E A H S	-	X	-	AMP 0.61	NAMP 0.075	NAMP 0.118	NAMP	NAMP 0.018	87-99	zona pellucida sperm binding protein 3 isoform X1 (XP_025009555.1)	1400.43	1400.59	4.35	-1.8	-2.9	-0.846	putative helix	
	G D P S A W S W G A E A H S = P2	-	X	-	AMP 0.90	NAMP 0.015	NAMP 0.170	NAMP	NAMP 0.108	86-99		1457.48	1457.61	4.35	-1.8	-2.9	-0.814	3.51 stable	putative helix
3	T P P F G G F = P3	X	X	-	AMP 2.25	AMP 0.999	NAMP 0.432	NAMP	NAMP 0.143	203-209	clusterin precursor (NP_990231.1)	721.81	722.35	5.19	-0.1	-0.9	0.129	81.23 unstable	rich in P or G
	T P P F G G F R	X	X	-	AMP 1.96	AMP 0.690	NAMP 0.338	AMP	NAMP 0.177	203-210		878.00	878.45	9.41	0.9	0.1	-0.450	rich in P or G	
	T P P F G G F R E A F V P P V Q R V	-	X	-	AMP 1.39	NAMP 0.055	NAMP 0.139	NAMP	NAMP 0.114	203-220		2001.32	2001.07	9.26	0.9	0.1	-0.061	putative helix	
4	T P P F G G F R E A F V P P V Q R V R	-	X	-	AMP 1.29	NAMP 0.049	NAMP 0.259	NAMP	NAMP 0.178	203-221	clusterin precursor (NP_990231.1)	2157.51	2157.17	11.70	1.9	1.1	-0.295	putative helix	
	H P F I Q H P V H G = P4	-	X	-	AMP 2.31	NAMP 0.390	NAMP 0.240	NAMP	NAMP 0.010	234-243		1168.32	1168.60	7.02	0.6	-0.9	-0.520	31.39 stable	rich in H
5.1	E I H P F I Q H P V H G F H R	-	X	-	AMP 2.3	NAMP 0.120	NAMP 0.041	NAMP	NAMP 0.075	232-246	ovolectin-116 precursor (NP_989900.1)	1851.11	1850.96	7.19	0.9	-0.9	-0.607	rich in H	
	G Q A A R P E V A P A P S T G G R	-	X	-	NAMP -0.51	NAMP 0.022	NAMP 0.229	NAMP	NAMP 0.001	568-578		1041.13	1041.53	6.10	-0.1	-0.9	-0.518	putative helix	
	G Q A A R P E V A P A P S T G G R	X	X	-	NAMP -1.05	NAMP 0.061	NAMP 0.194	NAMP	NAMP 0.062	562-578		1621.78	1621.84	9.60	0.9	0.1	-0.712	putative helix	
	G Q A A R P E V A P A P S T G G R I V A P G G H R A	-	X	-	NAMP -0.67	NAMP 0.413	NAMP 0.407	AMP	AMP 0.827	562-587		2480.78	2480.32	11.70	2.2	1.1	-0.381	putative helix	
	I G Q A A R P E V A P A P S T G G R	X	X	-	NAMP -0.51	NAMP 0.055	NAMP 0.300	NAMP	NAMP 0.207	561-578		1734.94	1734.92	9.60	0.9	0.1	-0.422	putative helix	
	Q A A R P E V A P A P S T G G R	X	X	-	NAMP -1.50	NAMP 0.060	NAMP 0.111	NAMP	NAMP 0.014	563-578		1564.72	1547.79	9.60	0.9	0.1	-0.731	putative helix	
	R P E V A P A P S T G G R	X	X	-	NAMP -0.86	NAMP 0.113	NAMP 0.113	NAMP	NAMP 0.002	566-578		1294.44	1294.69	9.60	0.9	0.1	-0.908	putative helix	
	S T D V P R D P W V V G S A H P Q A Q H T R	-	X	-	NAMP +1.63	NAMP 0.024	NAMP 0.040	NAMP	NAMP 0.082	622-643		2528.73	2528.22	6.66	0.4	-0.9	-1.245	putative helix	
	V Q Q E V A P A R G V V G G M V V P E G H R A	X	X	-	NAMP -0.61	NAMP 0.105	NAMP 0.250	NAMP	NAMP 0.077	459-481		2343.70	2343.23	6.73	0.2	-0.9	0.065	putative helix	
	V Q Q E V A P A R G V V G G M V V P E G H R A R	X	X	-	NAMP -0.88	NAMP 0.092	NAMP 0.216	NAMP	NAMP 0.099	459-482		2499.89	2499.34	9.49	1.2	0.1	-0.125	putative helix	

^aAntimicrobial property was predicted from the ADAM database using SVM (support vector machine), or from the cAMP database using SVM, RF (random forest), ANN (artificial neural network), or DA (discriminant analysis); for each prediction method, peptides are regarded as antimicrobial (AMP) or not antimicrobial (NAMP). “Origin” indicates the protein from which each peptide originates, and “Fragment” indicates the positions of the first and last amino acid residues in the protein sequence. Physicochemical properties are either experimental (MW, molecular weight determined by mass spectrometry) or theoretical, predicted using ProtParam tools (MW; pI, isoelectric point; GRAVY, hydrophobicity index; instability index), or Protein Calculator v3.4 (net charge at pHs 7.0 and 9.0). Structure features predicted using APD3 (Antimicrobial Peptide Calculator and Predictor) are indicated as “Comments”. Peptides selected for further study (P1–P4) are indicated in bold.

suggest that these metals are also retained; this is likely to be due to association with EW macromolecules.²⁵ However, such reductions in mineral levels are unlikely to explain the reduced bactericidal activity of the 400 Da EWF toward *S. Enteritidis* at 45 °C (or reduced growth seen in 400 Da EWF at 30 °C) since levels of these minerals are similar in the 10 kDa and 400 Da EWFs (Table 1).

One last difference between the 400 Da EWF, EW, and the 10 kDa EWF is pH, which was lower in the 400 Da EWF (Table 1). The importance of alkaline pH for the antimicrobial

activity is well reported.^{1,6} Therefore, it is reasonable to suggest that the lower pH measured in the 400 Da EWF could partly explain the lower bactericidal activity of this fraction compared to EW and 10 kDa EWF. From all of the physicochemical characteristics of 400 Da EWF determined here, its pH (8.7) is the most likely hypothesis to explain the least bacteria destruction observed at 45 °C in this medium in comparison to 10 kDa EWF. To test whether the reduced pH, glucose, or nitrogen concentrations of the 400 Da EWF compared to EW and 10 kDa EWF could account for its reduced bactericidal

activity, *Salmonella* survival was measured in the 400 Da EWF at 45 °C (and 30 °C as control) at pH 8.7 and 9.2, with glucose at 25 mM and nitrogen at 3 mM (final concentrations) (Figure 4). The modifications of 400 Da EWF did not significantly change ($p > 0.05$) bactericidal activity at 45 °C (Figure 4A), indicating that the changes in pH, glucose, and nitrogen availability are not responsible for the reduced bactericidal activity of the 400 Da EWF compared to the 10 kDa EWF. However, the combined increase in pH, nitrogen, and glucose content of the 400 Da EWF did result in a significant increase in *S. Enteritidis* growth at 30 °C, although growth was still lower than that obtained in 10 kDa EWF (Figure 4B). These findings indicate that nutrient (carbon and/or nitrogen sources) availability and pH are factors that impact *S. Enteritidis* growth in EW at 30 °C. Since adjusting pH, glucose, and nitrogen availability only partly restored growth in 400 Da EWF at 30 °C toward that seen in the 10 kDa EWF, it is likely that there are other differences between these filtrates that affect growth. As the iron, zinc, copper, and manganese levels are similar in the 400 Da and 10 kDa EWFs, it is unlikely that differences in availability of these metals would explain the difference in growth. Therefore, other factors are likely responsible for this effect.

Putative Antimicrobial Peptides (AMPs) Are Present in EW Ultrafiltrates. To test the possible involvement of small bioactive compounds in the bactericidal activity of EW and EWFs at 45 °C, the 10 kDa EWF, 400 Da EWF, and 400 Da EWR were analyzed by mass spectrometry (MS). No peptides could be detected in the 400 Da EWF, consistent with the very low nitrogen content measured in this fraction (equivalent to a peptide content of 0.06 g/L), but 12 peptides were identified in the 10 kDa EWF, the peptide content of which was estimated at 0.2 g/L. All 12 peptides were also detected in the 400 Da EWR in addition to 10 other peptides (Table 2). The higher number of peptides detected in the 400 Da EWR likely results from a higher concentration in the retentate (peptide content estimated at 0.44 g/L) with respect to that in the more diluted 10 kDa EWF. However, due to the detection threshold of LC-MS/MS analysis, it is likely that other peptides present at very low concentration might exist in EWFs. Similarly, because of technical limits which make the identification of peptides smaller than 5–6 amino acid residues and those larger than 40–45 amino acid residues impossible, the list of peptides detected in 10 kDa EWF and 400 Da EWR is likely not exhaustive. In particular, it is noteworthy that avian β -defensin 11 (AvBD11; 82 amino acid residues), gallin (OvoDA1; 41 amino acid residues), and OvoDB1 (45 amino acid residues), all previously identified in EW, were not detected in the present study.^{4,26,27}

The peptides identified originate mainly from ovocleidin-116 and clusterin, two minor proteins previously identified in EW^{28,29} (Table 2). Ovocleidin-116 is a major component of the eggshell matrix and a main actor of the regulation of eggshell calcification.³⁰ Hen egg clusterin is a structural component of the eggshell matrix and also identified in EW;³¹ clusterins are ubiquitous proteins with molecular chaperone function.³² Among the 11 peptides stemming from clusterin, four belong to the fragment [203–221: TPFFGGFREAFFPPVQRVR] (group 3, Table 2), five to the fragment [211–221: EAFVPPVQRVR] (group 1, Table 2), and two to the fragment [232–246: EIHPFIQHPVHGFHR] (group 4, Table 2). Among the nine peptides derived from ovocleidin-116 (group 5, Table 2), two

belong to the fragment [459–482: VQQEVA-PARGVVGGMVVPEGHRAR], six to the fragment [561–587: IGQAARPEVAPAPSTGGRIVAPGGHRA], and one corresponds to the fragment [622–643: STDVPRDPVWVWGSAPQAQHTR]. Moreover, two peptides originate from zona pellucida sperm binding protein 3, called ZP3. ZP3 is one of the five ZPs present in the vitelline membrane of bird eggs, all playing an important role in egg fertilization. ZP3 is especially involved in the binding of sperm in the germinal disk region of the yolk.^{33,34} Both peptides stemming from this protein and identified in 400 Da EWR belong to the fragment [86–99: GDPSAWSWGAEAHS] (group 2, Table 2). To the best of our knowledge, no antibacterial activity has been ever reported for ovocleidin-116, hen egg clusterin, and ZP3.

The main physicochemical properties of the peptides are summarized in Table 2. Their molecular weight ranges from 722 to 2528 Da, and their predicted pI from 3.39 to 11.8. A high proportion of these peptides (16 out of 22) is likely to form an α -helix. Moreover, most (17 out of 22) are predicted to be positively charged at neutral pH, and 13 are predicted to remain positively charged at pH 9 (close to the pH of 9.3 used in the present study, that is, the natural EW pH a few days after laying). A positive net charge and helicity are well-known characteristics of AMPs.³⁵ To further probe the potential antibacterial activity of the peptides identified, a bioinformatics approach was applied.

All of the peptide sequences identified were evaluated for their potential antimicrobial activity using web-based prediction tools in the ADAM and cAMP databases (see the Materials and Methods section). Nine peptides presented a negative ADAM score and were not considered for further analysis. All nine of these peptides stemmed from ovocleidin-116 (group 5, Table 2). In contrast, 13 peptides achieved a positive ADAM score ranging from 0.61 to 2.31. These 13 peptides can be divided into four groups, based on the shortest common sequence (Table 2). As a complement to this analysis based on the ADAM database, the cAMP prediction scores were calculated for these 13 peptides, using four different algorithms. To enable experimental determination of the antimicrobial activity of representative peptides from the set identified, four peptides were selected for synthesis on the basis of the following criteria: (i) the peptide showing the highest ADAM score within each of the four groups (1–4) of relevance (Table 1) and (ii) possessing at least one positive cAMP database score. Thus, four peptides (designated P1, P2, P3, and P4 in Table 2) were selected.

With a GRAVY index score above zero, P3 is considered a hydrophobic peptide, whereas P2 and P4 are mostly hydrophilic, and P1 has a predicted intermediary hydrophobic/hydrophilic nature (Table 2). Moreover, out of the four potential AMPs selected, P2 is the only one likely to form an α -helix, whereas P1 and P3 are rich in proline residues, well-known for their “helix-breaker” effect.³⁶ P1 and P3 are also predicted to be structurally unstable, based on instability index, whereas P2 and P4 are predicted as stable (Table 2).

Two of the Four Putative EW AMPs Selected Exert Bactericidal Activity against *S. Enteritidis* at 45 °C. To experimentally determine the antimicrobial activity of the four selected predicted AMPs, *S. Enteritidis* survival was assessed at 45 °C (and 30 °C for control) in 400 Da EWF with chemically synthesized P1, P2, P3, or P4 peptides, and the bacterial

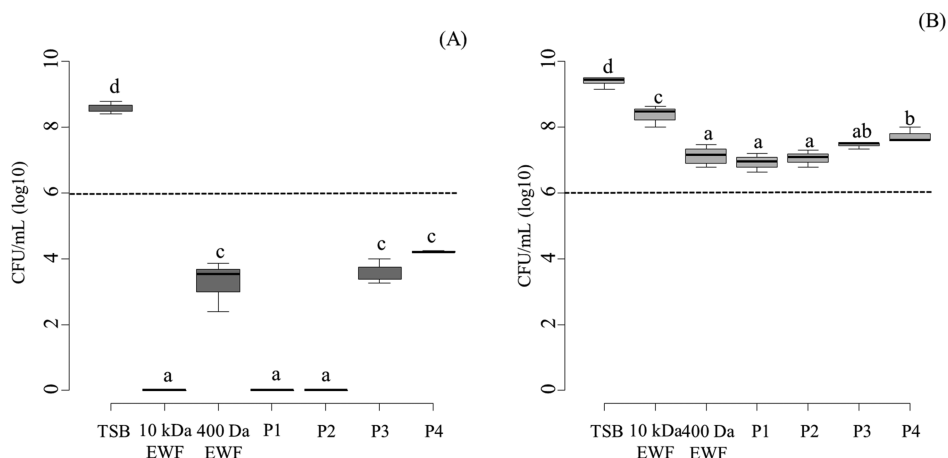

Figure 5. Effect of P1–P4 peptides on *S. Enteritidis* survival in 400 Da EWF. *S. Enteritidis* was incubated for 24 h at 45 °C (A) and 30 °C (B) in TSB pH 7.3, 10 kDa EWF, 400 Da EWF, and 400 Da EWF with addition of 100 $\mu\text{g}/\text{mL}$ of the P1, P2, P3, or P4 synthetic peptides. Bacteria were initially inoculated at 10^6 CFU/mL (dotted line). Means and standard deviations were calculated from three technical replicates. Samples with different letters display significantly different mean values ($p < 0.001$).

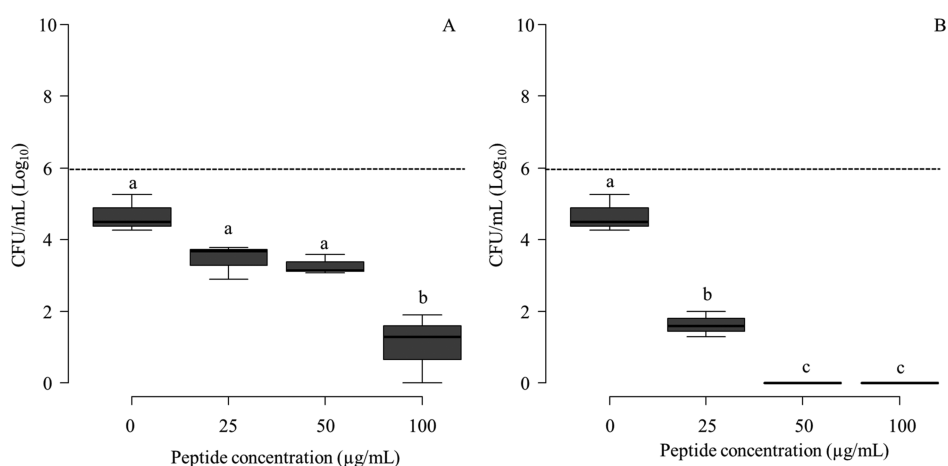

Figure 6. Effect of peptide concentration on the bactericidal activity of P1 and P2 against *S. Enteritidis* in 400 Da EWF at 45 °C. P1 (A) and P2 (B) were added at 0 to 100 $\mu\text{g}/\text{mL}$. Bacteria were initially inoculated at 10^6 CFU/mL (dotted line). Means and standard deviations were calculated from six replicates (two biological replicates, each with three technical replicates). Samples with different letters display significantly different mean values ($p < 0.01$ for (A), and $p < 0.001$ for (B)).

enumeration was compared to that obtained in 10 kDa EWF, 400 Da EWF, and TSB (Figure 5).

None of the four peptides tested displayed antibacterial activity at 30 °C (Figure 5B). Additionally, the P3 and P4 peptides had no effect on the bactericidal activity of 400 Da EWF at 45 °C (Figure 5A). In contrast, the P1 and P2 peptides (at 100 $\mu\text{g}/\text{mL}$; 119 and 69 μM for P1 and P2, respectively) strongly increased ($p < 0.001$) the bactericidal activity of 400 Da EWF at 45 °C. Indeed, the addition of either P1 or P2 resulted in a substantial 6 \log_{10} reduction of *S. Enteritidis* that is the same bactericidal effect as that observed for 10 kDa EWF at 45 °C (Figure 5A). Therefore, the results suggest that P1 and P2 contribute to the bactericidal activity of EW and EW ultrafiltrates at 45 °C. The effect of concentration on the bactericidal activities of P1 and P2 was also tested, and the results show a dose-dependent response for both peptides at 45 °C in 400 Da EWF over a concentration range of 0–100 $\mu\text{g}/\text{mL}$, with a higher bactericidal effect for P2 (Figure 6B) than for P1 (Figure 6A).

Thus, the P1 and P2 peptides can be classified as bactericidal peptides active against *S. Enteritidis* under the specific

conditions of EW or EW ultrafiltrates at 45 °C. Since 45 °C is close to the body temperature of the hen, P1 and P2 are likely to play a role in resisting *S. Enteritidis* infection during egg formation. However, the P1 and P2 peptides displayed no bactericidal activity in M63 minimal medium, even at 45 °C, either at pH 7.8 or 9.2 (Figure 7). Then, P1 and P2 peptides cannot explain by themselves the bactericidal activity of EW and EW ultrafiltrates at 45 °C. Actually, it is very likely that both peptides interact in EW, as well as in 10 kDa and 1 kDa EWFs, with other harmful factors such as nutrient deprivation, alkaline pH, or other unknown antimicrobial compounds.

To test any synergistic action for the P1 and P2 peptides, the bactericidal effect of combining the two peptides in 400 Da EWF at 45 °C was examined (Figure 8). The results show a clear synergistic effect for a 1:1 w/w combination of P1 and P2 (25 $\mu\text{g}/\text{mL}$ total concentration) with higher bactericidal activity compared to that obtained for each peptide alone at the same concentration (Figure 8). A 6 \log_{10} reduction of *S. Enteritidis* was obtained after 24 h incubation with the peptide mixture, whereas only 2.55 ± 0.48 and $4.5 \pm 0.15 \log_{10}$ reductions were obtained with P1 and P2 alone, respectively

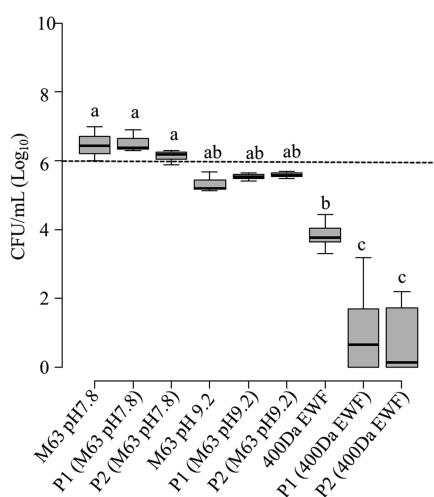

Figure 7. Effect of both AMPs P1 and P2 on *S. Enteritidis* survival in M63 minimal medium and in 400 Da EWF. *S. Enteritidis* was incubated for 24 h at 45 °C in M63 at pHs 7.8 and 9.2, and in 400 Da EWF, with or without addition of 100 μg/mL P1 or P2. Bacteria were initially inoculated at 10⁶ CFU/mL (dotted line). Means and standard deviations were calculated from three technical replicates. Samples with different letters display significantly different mean values ($p < 0.001$).

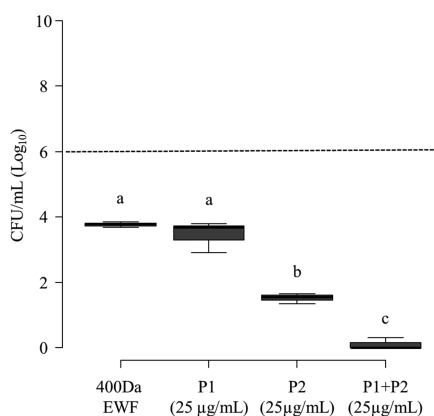

Figure 8. Synergistic bactericidal effect of the AMPs P1 and P2 against *S. Enteritidis* at 45 °C in 400 Da EWF. *S. Enteritidis* was incubated for 24 h at 45 °C in 400 Da EWF with addition of P1 (25 μg/mL), P2 (25 μg/mL), or P1 + P2 (12.5 μg/mL P1; 12.5 μg/mL P2). Bacteria were initially inoculated at 10⁶ CFU/mL (dotted line). Means and standard deviations were calculated from three technical replicates. Samples with different letters display significantly different mean values ($p < 0.001$).

(Figure 8). Combining P1 and P2 had no apparent effect on *S. Enteritidis* growth in 400 Da EWF at 30 °C compared to that observed in the absence of peptides (data not shown).

To conclude, this study has advanced understanding of the bactericidal activity of EW at 45 °C. In particular, two new AMPs (P1 and P2) have been identified in EW and their likely involvement in the bactericidal activity of EW has been revealed. The P1 and P2 peptides have characteristics commonly attributed to AMPs. These characteristics include a total hydrophobic ratio (defined using the APD tool: <http://aps.unmc.edu/AP/>³⁷) of 42 and 35% for P1 and P2, respectively, which matches the relatively high proportion (≥30%) of hydrophobic residues often associated with AMPs.³⁵ Moreover, P1 contains two Pro residues (28% of all

residues) and one Arg residue (14%), whereas P2 contains two Trp (14%), one Pro (7%), and one His (7%) residues, which are common features of AMPs.^{35,37} Furthermore, according to the APD tool for structure prediction, P2 may form an α -helix with at least three residues on the same hydrophobic surface, suggesting an amphiphilic helix folding pattern, as hypothesized for AMPs such as magainins or cecropins; this property is thought to promote interaction with the bacterial membrane.^{35,38} Finally, P1 has 43% similarity to an AMP registered in the APD database under ID AP02431 (TPPQS), which originates from *Bacillus subtilis*,³⁹ while P2 has 43% similarity to another AMP registered under ID AP02938 (GTAWR-WHYRARS), obtained from the rumen microbiome.⁴⁰ P1 has a predicted alkaline pI (pI = 9.75) and thus would be very slightly cationic at pH 9 (i.e., close to the pH here tested), while P2 is an acidic peptide (pI = 4.35). Thus, under the conditions tested here, neither P1 nor P2 have the strong cationic characteristics widely reported for AMPs, and regarded as critical for interaction between AMPs and bacterial membranes, which is considered as the first step leading to AMP-mediated membrane dysfunction and disruption.³⁵ Nonetheless, some anionic or noncationic peptides are proven AMPs,³⁸ suggesting that a cationic characteristic is not a strict requirement for AMP functionality. In any case, it is likely that P1 and P2 do not act like typical AMPs since their most striking feature is that their activity requires both a permissible temperature (45 °C) and a specific medium composition (EW or EWF).

Despite the original features of P1 and P2 in comparison to most of AMPs, the assumption of membrane disruption induced by these peptides is preferred. Indeed, a previous study evidenced membrane damage (inner and outer membranes) on *E. coli* during incubation under same conditions, i.e., in EW at 45 °C.⁴¹ Moreover, the influence of temperature on P1 and P2 bactericidal activity could be related to membrane fluidity as high temperatures increase the fluidization of biological membranes.⁴² Then, the ability of antimicrobial components to cross and/or disrupt the bacterial membrane increases as membrane fluidity rises. The mechanism governing the observed synergy between P1 and P2 is unclear, but this finding highlights the potential for synergistic action of antimicrobial components in EW.

Finally, this study confirms the antibacterial role of the EW peptide fraction, besides that of antibacterial proteins described for a long time.⁴ It is especially significant as only less is known about the antibacterial peptides naturally present in EW. Despite a great number of peptides have been identified in EW during the last decades thanks to proteomics, the biological functions of most of them, and especially their antimicrobial activities have still to be investigated.⁴ To date, an avian- β -defensin and a gallin have been identified in hen EW⁴³ and their antibacterial activities have been confirmed.^{26,44} These natural peptides both belong to the family of defensins, which are part of the innate immune system in many living species. Avian- β -defensins are cationic peptides of 1–9 kDa identified in the eggs of several bird species.⁴⁵ These peptides are expressed in many different tissues, including the hen oviduct,⁴⁶ which explains that the different compartments of hen egg contain avian- β -defensins, which are supposed to be involved in the protection of the embryo during hatching.²⁶ Ovodefensins, a subfamily of β -defensins including gallin (4732 Da), have been also identified in the EW of different bird species.⁴ Moreover, it is more than likely that EW contain

many other antimicrobial peptides, not yet identified, as indicated by the consequence of EW treatment with proteinase K. This treatment eradicated the anti-Salmonella activity of a 3 kDa EWF, suggesting that antimicrobial polypeptides smaller than 3 kDa play an active role in the antibacterial defense of EW.⁴⁷ However, what does differ between both peptides identified in the present study and antimicrobial peptides such as defensins is that P1 and P2 are not expressed as such from the hen genome, but are stemming from larger proteins, namely, clusterin and ZP3, respectively. This consequently indicates that these proteins have been hydrolyzed in situ. It is noteworthy that in quail eggs, a 26 amino acid sequence containing a homologous sequence of P2 peptide was removed from ZP3 after ovulation, presumably by a protease secreted in the infundibulum.⁴⁸ This might explain why P2 peptide, which stems from a vitelline membrane protein (ZP3), was found in EW. It could be hypothesized that this peptide, released from the vitelline membrane into the forming EW after ovulation, could play a role in protecting the embryo during the completion of egg formation in the oviduct. The fact that P2 peptide specifically acts at 45°C, close to the hen body temperature, supports this assumption. More generally speaking, protein degradation during formation and/or storage of eggs was previously reported, based on the decrease of the band intensity of some proteins in electrophoresis,⁴⁹ and more recently, the release of small peptides (<10 and <3 kDa) was also established.⁵⁰ However, the mechanisms responsible for the proteolysis still remain unknown in most cases. Various proteases naturally present in EW⁵¹ could catalyze the proteolysis. Self-degradation of proteins has been also described as a spontaneous and quite universal phenomenon.⁵² However, only small peptides stemming from ovotransferrin, ovomucin, ovomucoid, and ovoinhibitor, i.e., major proteins, have been described in EW to date.⁵⁰ In the present study, it is noteworthy that the EW fractionation strategy using ultra- and nanofiltration membranes, leading to a concentrated fraction (400 Da EWR), enabled the access to peptides stemming from minor EW proteins. Then, whereas protein degradation can be seen as a potentially detrimental phenomenon when it concerns antimicrobial proteins (ovotransferrin, lysozyme, ovoinhibitor, ovomucoid), the present study highlights it could also contribute to a higher protection of eggs against bacteria, thanks to the release of antimicrobial peptides from nonantimicrobial proteins such as clusterins and ZP3. Beyond the specific issue of egg protection, this study also underlines that egg white proteins, even nonantimicrobial ones, should be considered as potential natural sources of antimicrobial peptides. This has special relevance where innovative antimicrobial molecules are being sought to counteract increasing bacterial resistance, which is a major public health challenge.

AUTHOR INFORMATION

Corresponding Author

Marie-Françoise Cochet – STLO, INRAE, Institut Agro, 35042 Rennes, France; Phone: +33(0)223485575; Email: marie-francoise.cochet@agrocampus-ouest.fr

Authors

Florence Baron – STLO, INRAE, Institut Agro, 35042 Rennes, France

Sylvie Bonnassie – UFR Sciences de la Vie et de l'Environnement, Rennes 35700, France

Sophie Jan – STLO, INRAE, Institut Agro, 35042 Rennes, France

Nadine Leconte – STLO, INRAE, Institut Agro, 35042 Rennes, France

Julien Jardin – STLO, INRAE, Institut Agro, 35042 Rennes, France

Valérie Briard-Bion – STLO, INRAE, Institut Agro, 35042 Rennes, France

Michel Gautier – STLO, INRAE, Institut Agro, 35042 Rennes, France

Simon C. Andrews – School of Biological Sciences, Knight Building, University of Reading, Reading RG6 6AS, U.K.

Catherine Guérin-Dubiard – STLO, INRAE, Institut Agro, 35042 Rennes, France

Françoise Nau – STLO, INRAE, Institut Agro, 35042 Rennes, France

Complete contact information is available at:

<https://pubs.acs.org/10.1021/acs.jafc.0c06677>

Notes

The authors declare no competing financial interest.

ACKNOWLEDGMENTS

The authors thank Anne Dudley (Analytical Technical Services Division, University of Reading) for ICP-OES analysis.

ABBREVIATIONS USED

EW, egg white; EWR, egg white retentate; EWF, egg white filtrate; AMP, antimicrobial peptide; cAMP, collection of antimicrobial peptides; SVM, support vector machine; RF, random forest; ANN, artificial neural network; DA, discriminant analysis; GRAVY, grand average hydropathy value; APD, antimicrobial peptide database; Nano LC-MS/MS, nanoscale liquid chromatography coupled to tandem mass spectrometry; ICP-OES, inductively coupled plasma-optical emission spectrometry

REFERENCES

- (1) Alabdeh, M.; Lechevalier, V.; Nau, F.; Gautier, M.; Cochet, M.-F.; Gonnet, F.; Jan, S.; Baron, F. Role of Incubation Conditions and Protein Fraction on the Antimicrobial Activity of Egg White against Salmonella Enteritidis and Escherichia Coli. *J. Food Prot.* **2011**, *74*, 24–31.
- (2) Baron, F.; Gautier, M.; Brule, G. Factors Involved in the Inhibition of Growth of Salmonella Enteritidis in Liquid Egg White. *J. Food Protect.* **1997**, *60*, 1318–1323.
- (3) Garibaldi, J. A. Role of Microbial Iron Transport Compounds in Bacterial Spoilage of Eggs. *Appl. Microbiol.* **1970**, *20*, 558–560.
- (4) Baron, F.; Nau, F.; Guérin-Dubiard, C.; Bonnassie, S.; Gautier, M.; Andrews, S. C.; Jan, S. Egg White versus Salmonella Enteritidis! A Harsh Medium Meets a Resilient Pathogen. *Food Microbiol.* **2016**, *53*, 82–93.
- (5) Hald, T.; Baggesen, D. L. EFSA BIOHAZ Panel (EFSA Panel on Biological Hazards), 2014. *Scientific Opinion on the Public Health Risks of Table Eggs Due to Deterioration and Development of Pathogens*; European Food Safety Authority, 2014.
- (6) Kang, H.; Loui, C.; Clavijo, R. I.; Riley, L. W.; Lu, S. Survival Characteristics of Salmonella Enterica Serovar Enteritidis in Chicken Egg Albumen. *Epidemiol. Infect.* **2006**, *134*, 967.
- (7) Gantois, I.; Eeckhaut, V.; Pasmans, F.; Haesebrouck, F.; Ducatelle, R.; Immerseel, F. V. A Comparative Study on the Pathogenesis of Egg Contamination by Different Serotypes of Salmonella. *Avian Pathol.* **2008**, *37*, 399–406.

- (8) Lu, S.; Killoran, P. B.; Riley, L. W. Association of *Salmonella Enterica* Serovar Enteritidis YafD with Resistance to Chicken Egg Albumen. *Infect. Immun.* **2003**, *71*, 6734–6741.
- (9) Růžicková, V. Growth and Survival of *Salmonella Enteritidis* in Selected Egg Foods. *Vet. Med.* **1994**, *39*, 187–195.
- (10) Baron, F.; Bonnassie, S.; Alabdeh, M.; Cochet, M.-F.; Nau, F.; Guérin-Dubiard, C.; Gautier, M.; Andrews, S. C.; Jan, S. Global Gene-Expression Analysis of the Response of *Salmonella Enteritidis* to Egg White Exposure Reveals Multiple Egg White-Imposed Stress Responses. *Front. Microbiol.* **2017**, *8*, 829.
- (11) Raspoet, R.; Shearer, N.; Appia-Ayme, C.; Haesebrouck, F.; Ducatelle, R.; Thompson, A.; Immerseel, F. V. A Genome-Wide Screen Identifies *Salmonella Enteritidis* Lipopolysaccharide Biosynthesis and the HtrA Heat Shock Protein as Crucial Factors Involved in Egg White Persistence at Chicken Body Temperature. *Poult. Sci.* **2014**, *93*, 1263–1269.
- (12) De Vylder, J.; Raspoet, R.; Dewulf, J.; Haesebrouck, F.; Ducatelle, R.; Van Immerseel, F. *Salmonella Enteritidis* Is Superior in Egg White Survival Compared with Other *Salmonella* Serotypes. *Poult. Sci.* **2013**, *92*, 842–845.
- (13) Liot, R.; Anza, L. Procédé de Traitement de Blanc d'oeuf Liquide. 9608356, July 4, 1996.
- (14) Baron, F.; Cochet, M.-F.; Alabdeh, M.; Guérin-Dubiard, C.; Gautier, M.; Nau, F.; Andrews, S. C.; Bonnassie, S.; Jan, S. Egg-White Proteins Have a Minor Impact on the Bactericidal Action of Egg White towards *Salmonella Enteritidis* at 45 °C. *Front. Microbiol.* **2020**, *11*.
- (15) Bishop, B. M.; Juba, M. L.; Devine, M. C.; Barksdale, S. M.; Rodriguez, C. A.; Chung, M. C.; Russo, P. S.; Vliet, K. A.; Schnur, J. M.; van Hoek, M. L. Bioprospecting the American Alligator (*Alligator Mississippiensis*) Host Defense Peptidome. *PLoS One* **2015**, *10*, No. e0117394.
- (16) Lee, H.-T.; Lee, C.-C.; Yang, J.-R.; Lai, J. Z. C.; Chang, K. Y. A Large-Scale Structural Classification of Antimicrobial Peptides, <https://www.hindawi.com/journals/bmri/2015/475062/> (accessed April 13, 2018).
- (17) Baron, F.; Cochet, M. F.; Ablain, W.; Grosset, N.; Madec, M. N.; Gonnet, F.; Jan, S.; Gautier, M. Rapid and Cost-Effective Method for Microorganism Enumeration Based on Miniaturization of the Conventional Plate-Counting Technique. *Lait* **2006**, *86*, 251–257.
- (18) Magasanik, B. Regulation of Nitrogen Assimilation. In *Regulation of Gene Expression in Escherichia coli*, Lin, E. C. C.; Lynch, A. S., Eds.; Springer US: Boston, MA, 1996; pp 281–290.
- (19) van der Ploeg, J. R.; Iwanicka-Nowicka, R.; Kertesz, M. A.; Leisinger, T.; Hryniewicz, M. M. Involvement of CysB and Cbl Regulatory Proteins in Expression of the tauABCD Operon and Other Sulfate Starvation-Inducible Genes in *Escherichia Coli*. *J. Bacteriol.* **1997**, *179*, 7671–7678.
- (20) Schramke, H.; Laermann, V.; Tegetmeyer, H. E.; Brachmann, A.; Jung, K.; Altendorf, K. Revisiting Regulation of Potassium Homeostasis in *Escherichia Coli*: The Connection to Phosphate Limitation. *MicrobiologyOpen* **2017**, *6*, No. e00438.
- (21) Andrews, S. C.; Robinson, A. K.; Rodriguez-Quinones, F. Bacterial Iron Homeostasis. *FEMS Microbiol. Rev.* **2003**, *27*, 215–237.
- (22) Pontes, M. H.; Groisman, E. A. Protein Synthesis Controls Phosphate Homeostasis. *Genes Dev.* **2018**, *32*, 79–92.
- (23) Anjem, A.; Varghese, S.; Imlay, J. A. Manganese Import Is a Key Element of the OxyR Response to Hydrogen Peroxide in *Escherichia Coli*. *Mol. Microbiol.* **2009**, *72*, 844–858.
- (24) Outten, C. E.; O'Halloran, T. V. Femtomolar Sensitivity of Metalloregulatory Proteins Controlling Zinc Homeostasis. *Science* **2001**, *292*, 2488–2492.
- (25) Tan, A. T.; Woodworth, R. C. Ultraviolet Difference Spectral Studies of Conalbumin Complexes with Transition Metal Ions. *Biochemistry* **1969**, *8*, 3711–3716.
- (26) Hervé-Grépinet, V.; Réhault-Godbert, S.; Labas, V.; Magallon, T.; Derache, C.; Lavergne, M.; Gautron, J.; Lalmanach, A.-C.; Nys, Y. Purification and Characterization of Avian β -Defensin 11, an Antimicrobial Peptide of the Hen Egg. *Antimicrob. Agents Chemother.* **2010**, *54*, 4401–4409.
- (27) Gong, D.; Wilson, P. W.; Bain, M. M.; McDade, K.; Kalina, J.; Hervé-Grépinet, V.; Nys, Y.; Dunn, I. C. Gallin; an Antimicrobial Peptide Member of a New Avian Defensin Family, the Ovodefensins, Has Been Subject to Recent Gene Duplication. *BMC Immunology* **2010**, *11*, 12.
- (28) Hincke, M. T.; Nys, Y.; Gautron, J.; Mann, K.; Rodriguez-Navarro, A. B.; McKee, M. D. The Eggshell: Structure, Composition and Mineralization. *Front. Biosci.* **2012**, *17*, 1266–1280.
- (29) Reyes-Grajeda, J. P.; Moreno, A.; Romero, A. Crystal Structure of Ovocleidin-17, a Major Protein of the Calcified Gallus Gallus Eggshell. *J. Biol. Chem.* **2004**, *279*, 40876–40881.
- (30) Riou, C.; Cordeiro, L.-A.; Gérard, N. Eggshell Matrix Proteins OC-116, OC-17 and OCX36 in Hen's Sperm Storage Tubules. *Anim. Reprod. Sci.* **2017**, *185*, 28–41.
- (31) Mann, K.; Gautron, J.; Nys, Y.; McKee, M. D.; Bajari, T.; Schneider, W. J.; Hincke, M. T. Disulfide-Linked Heterodimeric Clusterin Is a Component of the Chicken Eggshell Matrix and Egg White. *Matrix Biol.* **2003**, *22*, 397–407.
- (32) Bertacchini, J.; Mediani, L.; Beretti, F.; Guida, M.; Ghalali, A.; Brugnoli, F.; Bertagnolo, V.; Petricoin, E.; Poti, F.; Arioli, J.; Anselmi, L.; Bari, A.; McCubrey, J.; Martelli, A. M.; Cocco, L.; Capitani, S.; Marmiroli, S. Clusterin Enhances AKT2-Mediated Motility of Normal and Cancer Prostate Cells through a PTEN and PHLPP1 Circuit. *J. Cell. Physiol.* **2019**, *234*, 11188–11199.
- (33) Nishio, S.; Kohno, Y.; Iwata, Y.; Arai, M.; Okumura, H.; Oshima, K.; Nadano, D.; Matsuda, T. Glycosylated Chicken ZP2 Accumulates in the Egg Coat of Immature Oocytes and Remains Localized to the Germinal Disc Region of Mature Eggs. *Biol. Reprod.* **2014**, *91*, No. 107.
- (34) Bausek, N.; Ruckenbauer, H. H.; Pfeifer, S.; Schneider, W. J.; Wohrab, F. Interaction of Sperm with Purified Native Chicken ZP1 and ZPC Proteins. *Biol. Reprod.* **2004**, *71*, 684–690.
- (35) Mahlapuu, M.; Håkansson, J.; Ringstad, L.; Björn, C. Antimicrobial Peptides: An Emerging Category of Therapeutic Agents. *Front. Cell. Infect. Microbiol.* **2016**, *6*, 194.
- (36) Williamson, M. P. The Structure and Function of Proline-Rich Regions in Proteins. *Biochem. J.* **1994**, *297*, 249–260.
- (37) Wang, G.; Li, X.; Wang, Z. APD3: The Antimicrobial Peptide Database as a Tool for Research and Education. *Nucleic Acids Res.* **2016**, *44*, D1087–1093.
- (38) Lei, J.; Sun, L.; Huang, S.; Zhu, C.; Li, P.; He, J.; Mackey, V.; Coy, D. H.; He, Q. The Antimicrobial Peptides and Their Potential Clinical Applications. *Am. J. Transl. Res.* **2019**, *11*, 3919–3931.
- (39) Ramachandran, R.; Chalasani, A. G.; Lal, R.; Roy, U. A Broad-Spectrum Antimicrobial Activity of *Bacillus subtilis* RLID 12.1, <https://www.hindawi.com/journals/tswj/2014/968487/> (accessed June 2, 2020).
- (40) Oyama, L. B.; Girdwood, S. E.; Cookson, A. R.; Fernandez-Teniente, N.; Privé, F.; Vallin, H. E.; Wilkinson, T. J.; Golyshin, P. N.; Golyshina, O. V.; Mikut, R.; Hilpert, K.; Richards, J.; Wootton, M.; Edwards, J. E.; Maresca, M.; Perrier, J.; Lundy, F. T.; Luo, Y.; Zhou, M.; Hess, M.; Mantovani, H. C.; Creevey, C. J.; Huws, S. A. The Rumen Microbiome: An Underexplored Resource for Novel Antimicrobial Discovery. *npj Biofilms and Microbiomes* **2017**, *3*, 1–9.
- (41) Jan, S.; Baron, F.; Alabdeh, M.; Chaari, W.; Grosset, N.; Cochet, M.-F.; Gautier, M.; Vié, V.; Nau, F. Biochemical and Micrographic Evidence of *Escherichia Coli* Membrane Damage during Incubation in Egg White under Bactericidal Conditions. *J. Food Protect.* **2013**, *76*, 1523–1529.
- (42) Los, D. A.; Murata, N. Membrane Fluidity and Its Roles in the Perception of Environmental Signals. *Biochim. Biophys. Acta, Biomembr.* **2004**, *1666*, 142–157.
- (43) Mann, K. The Chicken Egg White Proteome. *Proteomics* **2007**, *7*, 3558–3568.
- (44) Whenham, N.; Lu, T. C.; Maidin, M. B. M.; Wilson, P. W.; Bain, M. M.; Stevenson, M. L.; Stevens, M. P.; Bedford, M. R.; Dunn, I. C. Ovodefensins, an Oviduct-Specific Antimicrobial Gene Family,

Have Evolved in Birds and Reptiles to Protect the Egg by Both Sequence and Intra-Six-Cysteine Sequence Motif Spacing1. *Biol. Reprod.* **2015**, *92*, No. 154-1.

(45) van Dijk, A.; Veldhuizen, E. J. A.; Haagsman, H. P. Avian Defensins. *Vet. Immunol. Immunopathol.* **2008**, *124*, 1–18.

(46) Mageed, A. M.; Isobe, N.; Yoshimura, Y. Expression of Avian Beta-Defensins in the Oviduct and Effects of Lipopolysaccharide on Their Expression in the Vagina of Hens. *Poult. Sci.* **2008**, *87*, 979–984.

(47) Huang, X.; Hu, M.; Zhou, X.; Liu, Y.; Shi, C.; Shi, X. Role of YoaE Gene Regulated by CpxR in the Survival of *Salmonella Enterica* Serovar Enteritidis in Antibacterial Egg White. *mSphere* **2020**, *5* (1), e00638-19.

(48) Pan, J.; Sasanami, T.; Nakajima, S.; Kido, S.; Doi, Y.; Mori, M. Characterization of Progressive Changes in ZPC of the Vitelline Membrane of Quail Oocyte Following Oviductal Transport. *Mol. Reprod. Dev.* **2000**, *55*, 175–181.

(49) Guyot, N.; Labas, V.; Harichaux, G.; Chessé, M.; Poirier, J.-C.; Nys, Y.; Réhault-Godbert, S. Proteomic Analysis of Egg White Heparin-Binding Proteins: Towards the Identification of Natural Antibacterial Molecules. *Sci. Rep.* **2016**, *6*, No. 27974.

(50) Liu, M.; Yu, W.; Ren, F.; Wu, J. Formation and Characterization of Peptides in Egg White during Storage at Ambient Temperature. *Food Chem.* **2018**, *263*, 135–141.

(51) Mann, K.; Mann, M. In-Depth Analysis of the Chicken Egg White Proteome Using an LTQ Orbitrap Velos. *Proteome Sci.* **2011**, *9*, 7.

(52) Sharma, M.; Luthra-Guptasarma, M. Degradation of Proteins upon Storage at Near-Neutral PH: Indications of a Proteolytic/Gelatinolytic Activity Associated with Aggregates. *Biochim. Biophys. Acta* **2009**, *1790*, 1282–1294.

(53) Nys, Y.; Sauveur, B. Valeur nutritionnelle des oeufs, <http://prodinra.inra.fr/?locale=fr#!ConsultNotice:77361> (accessed Feb 17, 2016).

(54) Sauveur, B. Structure, Composition et Valeur Nutritionnelle de l'oeuf. In *Reproduction des volailles et production d'oeufs*; Lavoisier: Paris, 1988; pp 35–39.

(55) Nau, F.; Guérin-Dubiard, C.; Baron, F.; Thapon, J.-L. *Science et technologie de l'oeuf production et qualité* Technique et Documentation: Lavoisier; Vol. 1.

(56) Ciqual Table de composition nutritionnelle des aliments, <https://ciqual.anses.fr/> (accessed Jan 24, 2020).

(57) *Egg Science and Technology*, Stadelman, W. J.; Cotterill, O. J., Eds.; Macmillan Education UK: London, 1986.