



**HAL**  
open science

## **NOAW project deliverable 7.3: Best-practice guidelines for farms and businesses on agricultural waste management**

Szilvia Joó, Tünde Kuti, Csaba Baár, Andras Sebők, Florian Paillet, Eric Trably, Mechthild Donner, Hugo De Vries, Nathalie Gontard, Anne Verniquet,  
et al.

### **► To cite this version:**

Szilvia Joó, Tünde Kuti, Csaba Baár, Andras Sebők, Florian Paillet, et al.. NOAW project deliverable 7.3: Best-practice guidelines for farms and businesses on agricultural waste management. [Research Report] Campden BRI Magyarország Nonprofit Kft (CBHU). 2020, 89 p. hal-03346874

**HAL Id: hal-03346874**

**<https://hal.inrae.fr/hal-03346874v1>**

Submitted on 16 Sep 2021

**HAL** is a multi-disciplinary open access archive for the deposit and dissemination of scientific research documents, whether they are published or not. The documents may come from teaching and research institutions in France or abroad, or from public or private research centers.

L'archive ouverte pluridisciplinaire **HAL**, est destinée au dépôt et à la diffusion de documents scientifiques de niveau recherche, publiés ou non, émanant des établissements d'enseignement et de recherche français ou étrangers, des laboratoires publics ou privés.

# NoAW project



**Innovative approaches to turn agricultural waste into ecological and economic assets**

## ***D7.3***

***Best-practice guidelines for farms and businesses on agricultural waste management***

**Planned delivery date (as in DoA): 31/03/2020 (M42)**

**Actual submission date: 28/05/2020 (M44)**

**Workpackage: 7**

**Workpackage leader: CBHU**

**Deliverable leader: CBHU**

**Dissemination level: PU**

**EC Version: V1**

**Research and Innovation action: GA no. 688338**

**Start date of the project: October 1<sup>st</sup>, 2016**

**This project has received funding from the European Union's Horizon 2020 research and innovation programme under grant agreement No 688338**

## TABLE OF CONTENTS

<b>1. Document Info .....</b>	<b>4</b>
<b>2. Summary.....</b>	<b>6</b>
<b>3. Introduction .....</b>	<b>7</b>
<b>4 Valuable raw materials in agricultural wastes .....</b>	<b>8</b>
4.1 Straw and stalk from cereals crop .....	9
4.2 Animal manure from livestock farming.....	11
4.3 Winery wastes in the context of production grapes and wines.....	14
4.4 Review of legislation.....	15
4.4.1 EU Waste Legislation & Circular Economy Package .....	17
4.4.2 EU Agricultural & Fertiliser Regulation.....	18
4.4.3 EU legislation on Food Contact Materials .....	21
4.5 Concluding remark .....	21
<b>5 Best practices and methods for agricultural waste valorisation .....</b>	<b>22</b>
5.1 Overview of the main possibilities of agricultural waste valorisation routes .....	22
5.2 Biomaterials, bioplastics: Summary of bioplastics, production of PLA, PHAs (PHB, PHV) and their uses, cellulosic materials, starch, etc. ....	24
5.3 Biogas production and bioenergy.....	30
5.3.1 Biogas in the context of Bioeconomy .....	31
5.3.2 Biogas upgrading into biohythane at pilot scale .....	33
5.4 Organic fertilizer production and composting .....	36
5.4.1 Fertiliser products from digestate .....	38
5.4.2 Comparison of specific costs for digestate treatment methods .....	43
5.4.3 Best practice example: Agroenergie Hohenlohe GmbH.....	44
5.4.4 Best practice example: High nutrient dense ABC-BioPhosphate recovery from food grade animal bones	46
5.5 Best practice examples of waste valorisation routes .....	49
5.6 System approach for waste and loss analysis .....	51
<b>6 Business models for agro-waste valorisation for practical implementation .....</b>	<b>61</b>
6.1 Main triggers of eco-innovations .....	61
6.2 Success and failure factors of existing eco-innovative case studies .....	64
6.3 Business model development using business model canvas .....	70

---

6.4	Summary of business models developed .....	77
<b>7</b>	<b>Success stories (see detailed in NoAW D5.1) .....</b>	<b>79</b>
<b>8</b>	<b>Conclusion.....</b>	<b>82</b>
<b>9</b>	<b>References .....</b>	<b>83</b>
<b>10</b>	<b>Partners involved in the work .....</b>	<b>86</b>
<b>11</b>	<b>FAIR Data management .....</b>	<b>87</b>
<b>12</b>	<b>Annexes.....</b>	<b>88</b>
12.1	List of Figures.....	88
12.2	List of Tables .....	89

## 1. Document Info

### 1.1. Author(s)

Organisation name lead contractor	CBHU	
Author	Organisation	e-mail
† Szilvia Joó	CBHU	
Tünde Kuti	CBHU	<a href="mailto:t.kuti@campdenkht.com">t.kuti@campdenkht.com</a>
Csaba Baár	CBHU	<a href="mailto:c.baar@campdenkht.com">c.baar@campdenkht.com</a>
András Sebők	CBHU	<a href="mailto:a.sebok@campdenkht.com">a.sebok@campdenkht.com</a>
Florian Paillet	INRAE	<a href="mailto:florian.paillet@inra.fr">florian.paillet@inra.fr</a>
Eric Trably	INRAE	<a href="mailto:eric.trably@inrae.fr">eric.trably@inrae.fr</a>
Mechthild Donner	INRAE	<a href="mailto:mechthild.donner@inrae.fr">mechthild.donner@inrae.fr</a>
Hugo De Vries	INRAE	<a href="mailto:hugo.de-vries@inrae.fr">hugo.de-vries@inrae.fr</a>
Nathalie Gontard	INRAE	<a href="mailto:nathalie.gontard@inrae.fr">nathalie.gontard@inrae.fr</a>
Anne Verniquet	SOFIES	<a href="mailto:anne.verniquet@so-fiesgroup.com">anne.verniquet@so-fiesgroup.com</a>
Annamaria Celli	UNIBO	<a href="mailto:annamaria.celli@unibo.it">annamaria.celli@unibo.it</a>
Katrin Kayser	IBBK	<a href="mailto:k.kayser@ibbk-biogas.de">k.kayser@ibbk-biogas.de</a>
Burkhard Schaer	ECOZ	<a href="mailto:schaer@ecozept.com">schaer@ecozept.com</a>
Denise Gider	ECOZ	<a href="mailto:gider@ecozept.de">gider@ecozept.de</a>
Mauro Majone	UNIROMA	<a href="mailto:mauro.majone@uniroma1.it">mauro.majone@uniroma1.it</a>
Marianna Villano	UNIROMA	<a href="mailto:marianna.villano@uniroma1.it">marianna.villano@uniroma1.it</a>

### 1.2. Revision history

Version	Date	Modified by	Comments
1	27.03.2020	Csaba Baár	Starting version
2	30.04.2020	Csaba Baár	Internal review : ammendments
3	11.05. 2020	Csaba Baár	2 <sup>nd</sup> internal review : ammendments
4	26.05.2020	Csaba Baár	3rd internal review : ammendments

---

### 1.3. Dissemination level

<b>This deliverable is part of a project that has received funding from the European Union's Horizon 2020 research and innovation programme under grant agreement No. 688338</b>	
--	--

<b>Dissemination Level</b>	
----------------------------	--

PU Public	
-----------	--

	PU
--	----

## 2. Summary

<p><b>Background</b></p>	<p>The NoAW project is dealing with innovative approaches to turn agricultural waste into ecological and economic assets using a circular economy approach for agricultural wastes on a territorial and seasonal scale. Mostly unavoidable and continuously generated agricultural wastes are a true resource for valorisation. The agricultural waste can be converted into bioenergy and bio-based products by cascading conversion processes, which may yield potentially to sustainable bio-products such as energy, fertilizers, bio-materials (e.g. bio-packages) and biochemical molecules.</p> <p>The agro wastes should be rather considered and called agricultural by-products: turning waste into resources is one of the key elements of a circular economy and “near-zero-waste-society”.</p>
<p><b>Objectives</b></p>	<p>The best practice guideline was prepared by the No-Agricultural Waste (NoAW) for farms and businesses on agricultural waste management.</p> <p>It aims to show best practices and new solutions with special focus on manure, straw and winery wastes to serve and facilitate the implementation of circular economy and environmental investments reducing environmental impacts in the agriculture, by valorising agricultural by-products that would otherwise mainly be landfilled or burned.</p>
<p><b>Methods</b></p>	<p>Views from a broad team of NoAW experts were integrated in this guideline. Specifically, members of the NoAW Knowledge Exchange Stakeholder Platform were consulted in order to obtain the broadest view possible with the connected stakeholders.</p> <p>In practice, the following approach was followed. First, the topics, the table of content, the responsible writers for each chapter and the deadlines were discussed and agreed. Then the compiled versions were sent out for further comments (three times to the task partners, once to the Knowledge Exchange Stakeholder Platform, and once to everyone in consortia). The draft version was made public on the internet for discussion. After the final correction, the deliverable was prepared.</p>
<p><b>Results &amp; implications</b></p>	<p>This guide gives an overview about the types of agricultural wastes that can be valorized and presents these valuable materials (in particular the options related to straw and stalk from cereals crop, animal manure from livestock farming, winery wastes).</p> <p>The guideline also shows the best practices and methods for agricultural waste valorisation, gives best practice examples and presents success stories as well. Beyond that to help the practical implementation of the new solutions gives an overview of the business model development for agro-waste valorisation.</p> <p>Finally, the guideline served as a basis for the compilation of related training materials in the topic subject, thus facilitating to write modules of training courses.</p>

---

### 3. Introduction

Agricultural by-products are a huge pool of (partly) untapped biomass resources, with significant potential of economic value generation and reduction of environmental burdens in many regions of Europe and the world, especially considering the trend of specialization and separation of animal husbandry and crop production. Many agricultural wastes can be used for the production of bioenergy, a state of the art technology in Europe, and bio-based products (for example biofertilizers or bioplastics) hereby exploiting them as true resources, within a circular economy context. They should be rather considered and called agricultural by-products. However, there are still some major challenges in managing these biomass streams, promoting the effective use of resources and waste reduction.

Agricultural by-products are usually defined as plant or animal residues that are not (or not further processed into) food or feed, most often creating additional environmental and economic burdens in the farming and primary processing sectors. To further improve resource efficiency, reducing waste and improving waste management in primary production is considered of paramount importance to promote the circular economy. Agricultural by-products can be turned into resources using intensified conversion processes, which may yield to sustainable bio-products such as fertilizers, energy, materials and chemical molecules. The residues valorisation is crucial for supporting the decoupling of economic growth and human well-being from (primary) resources use, preventing putting pressure on land, causing adverse effects on biodiversity and jeopardizing global food security.



## 4 Valuable raw materials in agricultural wastes

The range of agricultural wastes and/or by-products that can be valorised in primary production are quite large in general. These streams are generated during production, rearing or growing of primary products including harvesting of the crop, milking and farmed animal production.

Value of agricultural by-products often depends on the ratio between value for the by-product and cost for transportation and processing (e.g. nutrients in manure). This is a big challenge!

The usability of the crop by-products (for example, cereal straw, beet leaves, potato foliage, corn cobs, etc.) is relatively wide, varying from the feed, litter in rearing, building material (insulation), to bioenergy, biofuels and bioplastics. Likewise, specific streams from biorefining crop residues may deliver platform molecules.

The transformation of agricultural wastes and by-products into biofuels and value-added molecules is becoming increasingly popular as a way to mitigate global warming, to diversify energy sources and fulfilling the growing demand for biobased solutions. For this purpose, circular bio-economy based on agricultural wastes and by-products has become a major issue for sustainable development of the agricultural sector.

Anaerobic digestion (AD) is a biological process by which organic matter is transformed in absence of oxygen into valuable biomolecules (like methane in biogas, or hythane (blend of methane and hydrogen) or volatile fatty acids). AD process has been found to be a promising route for the valorisation of agricultural wastes such as manure, crop residues and winery wastes. The biogas produced can be valorised as transport biofuel or injected in the national gas grid (biomethane after a purification step) or further converted into heat and electricity through a Cogeneration (Combined Heat and Power - CHP) system. Through specific AD processes, biodegradable polymers can be produced, like polyhydroxy-alkanoates, PHAs, which could replace, at least partially, the traditional oil-based plastics.

Winery residues, olive wastes and several other agro-processing wastes streams are rich in bioactive compounds like polyphenols. Due to the continuously increasing consumer demand for the use of a natural compound, there is a growing interest in the utilization of grape and winery by-products.

By these innovative routes we can extract from winery wastes bio-active chemicals, that can be exploited as building-blocks for new bio-based materials or antioxidant additives; moreover, winery wastes can be converted into bio-polymers, from which new composites can be also prepared. In this way, NoAW will contribute to enlarge the resources for sustainable packaging production. Besides, a nutrient-rich digestate is produced. It is generally used as fertilizer. In Germany, also bio-fertilizer is produced for (home) gardeners. An integrated production system with conventional and innovative end-products of agricultural waste valorisation are summarized in Figure 1. (Gontard, és mtsai., 2018).

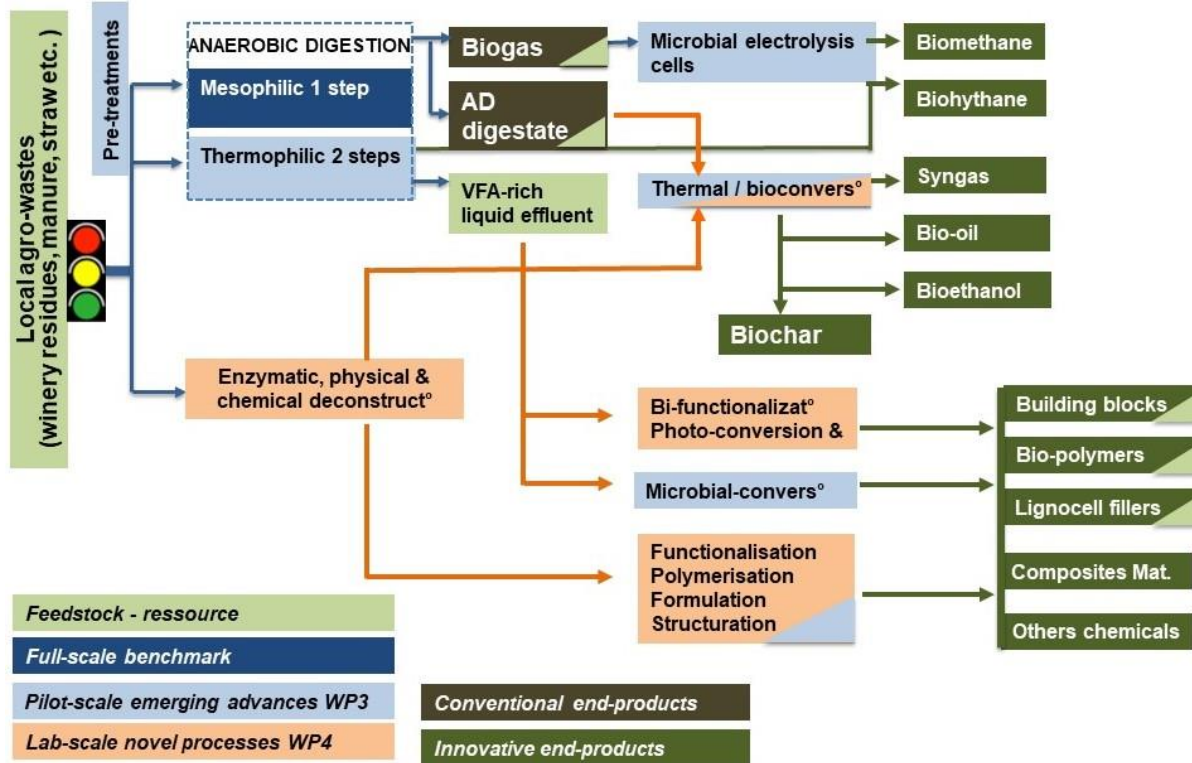

Figure 1: Integrated biorefinery system that produces conventional and innovative end-products from agro-wastes [Gontard et al. 2018]

Agro-waste presents potentially high opportunities as a source of added value bio-molecules and bio-products. However, its molecular complexity and heterogeneity complicates its eco-efficient conversion. Presently, only 5% of chemicals are bio-based, whereas it is known that agricultural products, lignocellulosic material and waste biomass could be converted to platform chemicals (Pfaltzgraff et al. 2013) and then to secondary chemicals, intermediates and final products (Jang et al. 2012).

The straw left after harvest is mostly under-valorised even though it can serve as one of the inputs for renewable energy and materials.

The next subchapters focus into three valuable group of agricultural by-product: crop residues, animal manure and winery wastes.

### 4.1 Straw and stalk from cereals crop

Huge amount of straw and stalk as agriculture by-products generated during harvesting from the cultivated cereal crops (straw from wheat, spelt, rye, rice, barley, oat, and triticale, stalk from maize).

As it is shown in Figure 1, the cultivated production of cereals (including rice) in the European Union (EU) was 310 million tonnes in 2017, which means about 12 % of global production. Common wheat and spelt represented 46 % of all cereal grains harvested in the EU in 2017. The next shares in order are: grain maize and corn-cob-mix 21 %, barley 19 %, oats 2.6%, rye and winter cereals mixtures 2.5% and remaining other cereals 9.1% (Eurostat online data code: apro\_cpnh1). The share of the total cereals production in other years in the period 2008-2017 was similar.

This project has received funding from the European Union’s Horizon 2020 research and innovation programme under grant agreement No 688338

## Share of main cereals, EU-28, 2017

(% of EU-28 total cereals production)

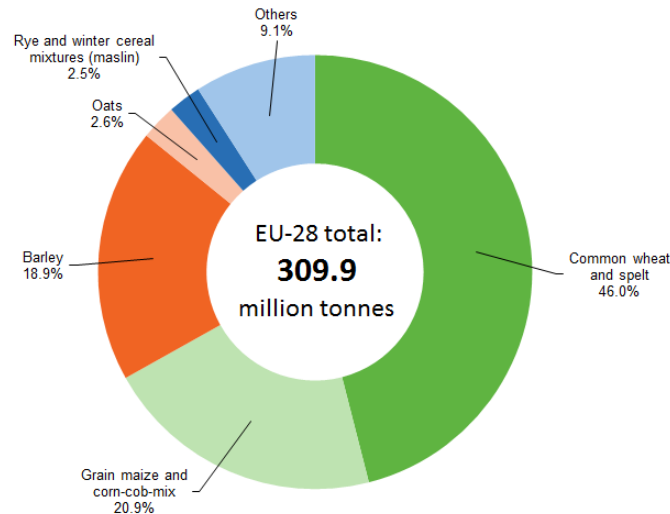

Note: 'Total cereals' includes cereals for the production of grain (including seed). 'Others' includes rice, triticale, sorghum and buckwheat, millet, canary seed, etc.)  
 Source: Eurostat (online data code: apro\_cpnh1)

eurostat 

Figure 2: Share of main cereals, Eu-28, 2017

### Straw

Among different lignocellulosic raw materials, wheat straw is very suitable for a biorefinery approach (Tomás-Pejó et al., 2017). The production of 1 kg of wheat grain generates of 1.1 kg of straw (Bamaga et al., 2003). Straw often also used for animal bedding (mainly for cattle).

It should be emphasized that only a part of the straw is collected; the bottom part of the stems is released on the soil, consequently, more than 50% from the organic matter remains in the field. There are other limiting factors which reduce the current straw production: both the modern combines cut the stems higher and grind more the straw, and the cereal breeding to prevent lodging of grain is directed towards the production of short stems varieties.

However, straw has value for soil quality, because important for maintaining soil organic matter. Therefore, the volume of straw that may be removed requires attention and agricultural expertise.

### Corn residues

Traditionally if the grain yield was poor and the yield of cereal straws was below normal, after harvest cobs the remained part of maize was used by small farms as bedding or even as feed replacement too. Corn is one of the main agricultural crops in EU countries and worldwide. The corn residues (including mainly stalks and cobs) are also valuable. Corn stover consists of the different part of the plant like stalk, leaves, husks, cobs, tassels, which belongs to the second-generation ethanol crops. However, there are challenges in harvesting, handling, storing and transporting the biomass.

In the US the milled cobs used for various industries (feed filler-additive, oil-drilling adsorbent, desiccant, or bio-abrasive). The usage of corn cobs is being developed as a feedstock for gasification projects, co-firing, and cellulosic ethanol. On dry matter basis cob represent about 16% of the total stover biomass in a field, and the yield of cobs is in average 14% of the grain yield (Dahiya et al., 2015).

This project has received funding from the European Union's Horizon 2020 research and innovation programme under grant agreement No 688338

Italian researchers (Blandino et al, 2016) found the relative yield of maize cobs are about 18.7%. Due to its composition cob is more stable than other vegetative parts (leaves, stalks) of maize, therefore cobs could be used as feedstock in different ways, like as freshly harvested, or stored by silage (alone or mixed with maize plant).

The stalks of maize represent also a significant bioenergy potential, or the cobs residues can be used as valuable raw material to produce bio packaging compounds.

## 4.2 Animal manure from livestock farming

There are varieties of animal manures (e.g. livestock dung, liquid manure from livestock holding facilities) from the farming stage. As fertiliser, the animal manure is one of the most used by-products in agriculture: if handled properly, manure can represent a valuable resource for its nutrients recovery for agriculture. However, the handling and storage of manure may lead to problems such as e.g. odours, ammonia evaporation, pathogens, nutrient run-off and infiltration into water bodies caused by nutrient leaching, and greenhouse gas emissions. Part of the organic matter is quickly degraded on/in the soil, which is considered ineffective.

### New statistics of nitrogen inputs to agricultural soils from livestock manure (FAO New Statistics, 2018)

The statistics of nitrogen inputs to agricultural soils typically involve the manure applied to soils, manure left on pasture and synthetic (chemical) fertilisers.

Highlights from these new statistics:

- i) Global N input from livestock manure and synthetic (chemical) fertiliser during the period 1961 – 2014 (see Figure 3):
  - the whole Global input from all livestock increased from 66 to 113 million tonnes of N (Mt N) with 71% (however, this increase was caused mostly by manure left on pasture);
  - Due to the higher demand of modern agriculture, was a seven-fold increase (from 12 to 102 Mt N) in the usage of chemical fertiliser
    - caused by this huge increase, the inputs from synthetic fertiliser became not only comparable with inputs from livestock, but in 2014 they represented the highest proportion of N inputs

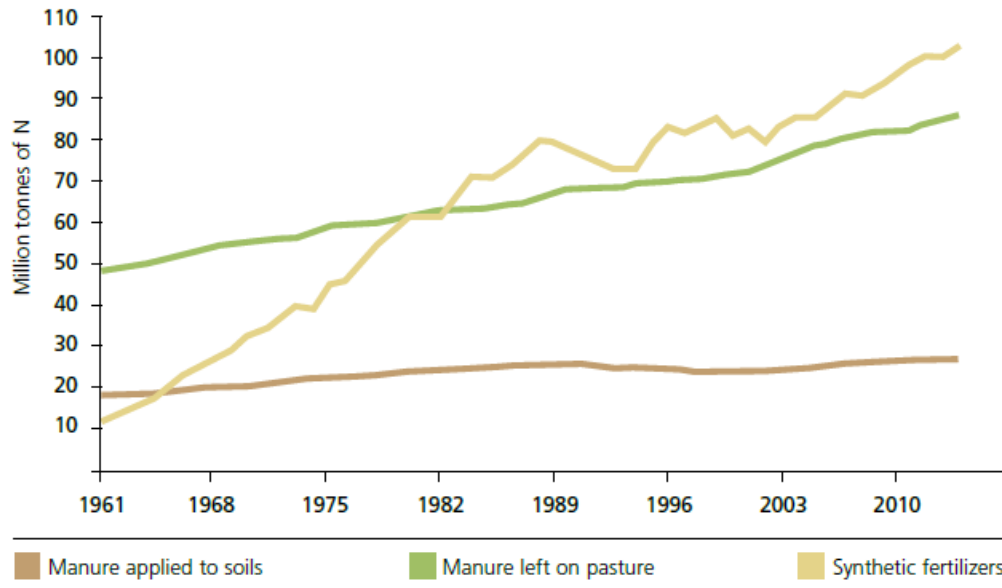

Figure 3: Global N input from livestock manure and synthetic (chemical) fertiliser during the period 1961 – 2014

- ii) Regional (only Asia and Europe) N inputs from livestock manure and synthetic (chemical) fertiliser during the period 1961 – 2014
  - Asia (see Figure 4 ):
    - the N input from manure left on pasture increased from 4 million tonnes in 1961 to about 12 million tonnes in 2014 by 140 percent (despite this growth, the ratio of the N inputs from manure deposited on pasture reduced significantly to a half (from 61% in 1961 to 30% in 2014))
    - Manure-N applied to soils increased from 4 million tonnes of N in 1961 to about 12 million tonnes of N in 2014
    - was 26 fold increase in the usage of synthetic N-fertiliser, and 2014 synthetic fertilizers accounted for 56.7 million tonnes of N and represented almost 60 percent of total N inputs.

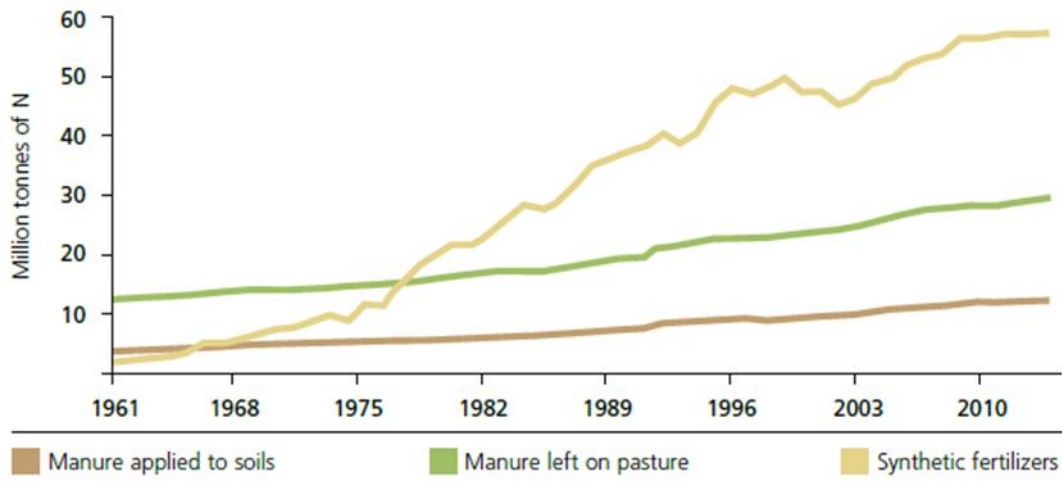

Figure 4: Asia, Regional N input from livestock manure and synthetic fertilizers, 1961-2014

- Europe (see Figure 5):
  - The usage of synthetic N-fertiliser increased from 33% of the total in the 1960s to about 55 percent by the 1980s. However, there was a marked decrease in fertilizer N inputs from 1980s to the 1990s (it is worth mentioning, that Europe was the only global region where the use dropped). This nearly 50 percent decrease could be due to the EU nitrate directive that led to tight limitations in nutrient use (Sutton et al., 2011)

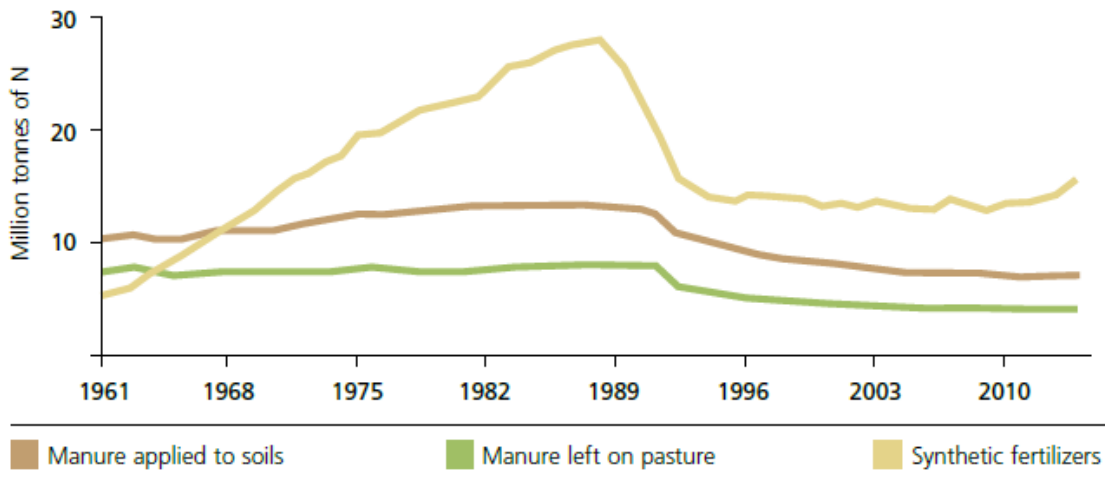

Figure 5: Europe, Regional N input from livestock manure and synthetic fertilizers, 1961-2014

### 4.3 Winery wastes in the context of production grapes and wines

Grape production is one of the main extended agro-economic activities in the world. As stated in the 2019 Report on World Vitiviniculture of the International Organization of Vine and Wine (OIV 2019), 77.8 million tons of grapes were produced globally in 2018. The grape production (grapes intended for all uses, as wine, table and dried grapes) shows an increasing trend between 2000 – 2018 (see Figure 6). The majority of this production was wine grape (57%), followed by table grape (36%) and dried grape (7%).



Figure 6: The evolution of the global grapes production, 2000-2018

Source: 2019 Report on World Vitiviniculture of the International Organization of Vine and Wine

In 2018 the global wine production was 292 million hectolitres (mhl). Italy was the first wine-producing country in the world with 54.8 mhl, followed by France with 48.6 mhl, and Spain with 44.4 mhl. Figure 7 shows the world wine production by countries in 2018.



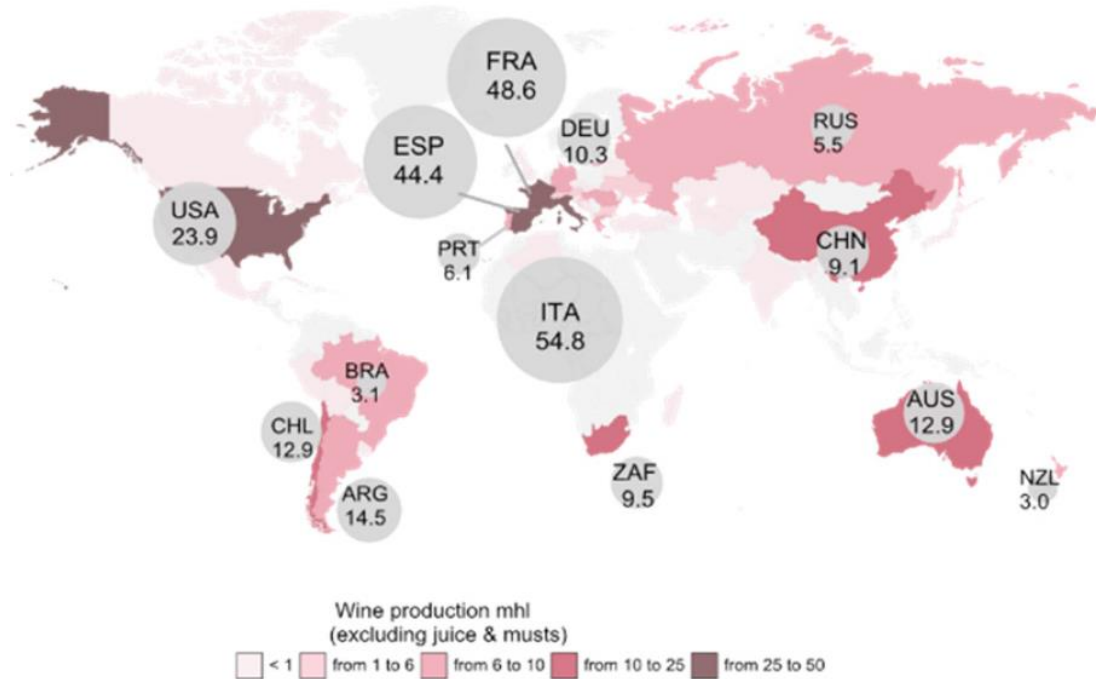

Figure 7: Wine production by countries, 2018

Source: 2019 Report on World Vitiviniculture of the International Organization of Vine and Wine

The winery sector is a high waste stream producer, because they dispose of a large amount of grape pomace.

In the leading countries of the global wine production, like Italy, France and Spain the estimated annual grape pomace is nearly 1200 tonnes per year (Beres et al., 2017).

Winery waste can be divided into two main categories, solid and liquid waste. Solid waste is generated during the collection of grapes and mixed waste is generated during the winemaking process. The main winery wastes are grape stalks, grape pomace and grape seeds and wine lees (Da Ros et al., 2016a; Da Ros et al., 2016b; Zacharof, 2016)

The main components of pomace are seeds, stems, residual pulp and skin: all contain a significant amount of bioactive compounds, such as phenols, and fibres. It is reported that about 70% of phenolic content is retained in grape pomace after wine processing.

#### 4.4 Review of legislation

NoAWs concept is to valorise agricultural residues and by-products to substitute fossil-based energy, plastics, chemicals and fertiliser. To achieve this existing anaerobic digestion plants shall serve as hubs for additional or improved processes studied in this project. For optimising the whole process, NoAW looks at the feedstock, digestion process itself and the output streams, which partly cover already existing outputs like biogas and digestate, but also innovative outputs like biopolymers as a basis for biobased and possibly biodegradable plastics. It is obvious that the legislation related to agricultural waste valorisation has to cover all areas from feedstock via the biogas plant to the different output streams. Thus, the respective legislation covers topics from the following sectors:

This project has received funding from the European Union’s Horizon 2020 research and innovation programme under grant agreement No 688338



- Waste Management / Circular Economy
- Agriculture & Organic agriculture
- Emission Control (air, soil, water)
- Chemical Safety,
- Construction,
- Product's safety,
- Plastics,
- Energy & Vehicle Fuels,
- Food Safety,
- Packaging,
- Worker's health and Safety
- (Natural) Gas

While some of the listed sectors are well covered by legislation – in this case, we are focussing on EU-Directives that have already been or soon need to be implemented into national legislation –, other sectors don't cover possible products from agricultural by-product valorisation properly. Especially biobased and biodegradable plastics are only partly considered as a reasonable step to reduce the effects of plastics accumulation in the environment. Figure 8 shows a schematic representation of how the typical biogas system and as other possibilities, the added NoAW-system relates to current EU legislation.

Within the frame of this Best Practice Guide, the focus is put on legislation about the feedstock and the products that are studied in the NoAW project. Legislation relating to the technical, economic and organisational aspects of the biogas plant and technical NoAW add-ons will not be discussed here. Also exempt from this overview is the legislation on the use of renewable energies, as this legislation is considered to target already the existing biogas sector and is not considerably affected by the NoAW products.

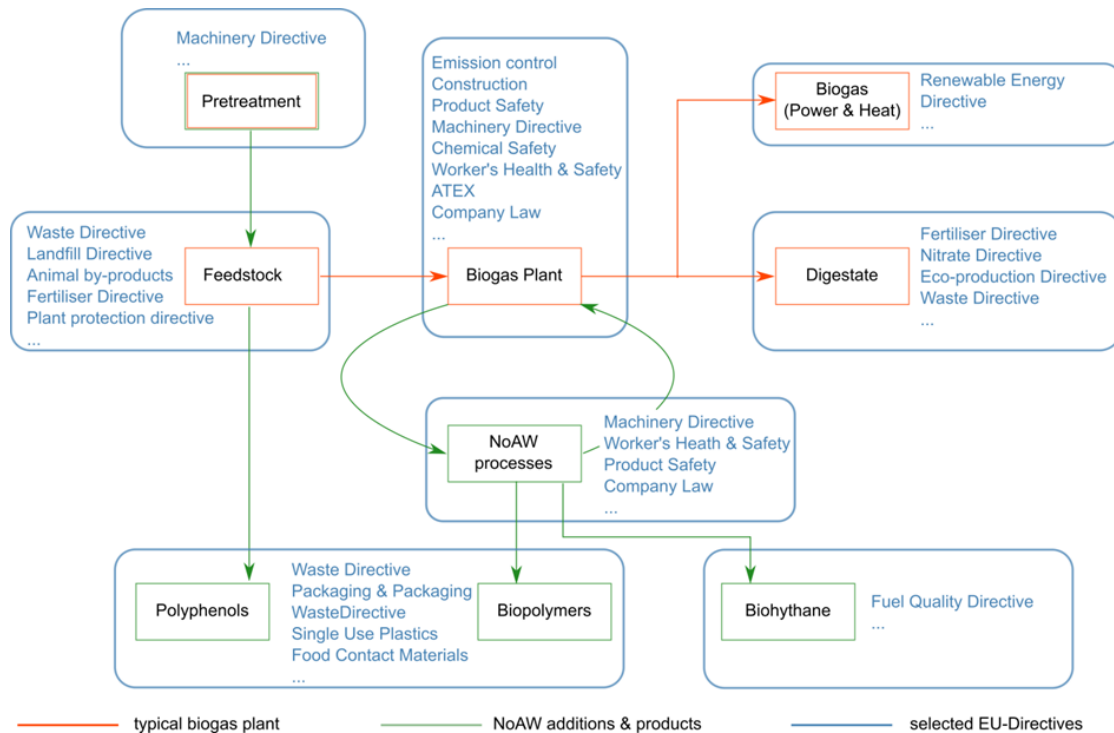

Figure 8: EU legislation and how it relates to the NoAW-project (non-exhaustive representation)

#### 4.4.1 EU Waste Legislation & Circular Economy Package

The EU the Waste Framework Directive (WFD) – Directive 2008/98/EC – sets the basic concepts and definitions related to waste management, such as definitions of waste, recycling, recovery. It explains when a waste ceases to be a waste and becomes a secondary raw material (so-called end-of-waste criteria), and how to distinguish between waste and by-products. The Directive lays down some basic waste management principles: it requires waste to be managed without endangering human health and harming the environment, and in particular without risk to water, air, soil, plants or animals, without causing a nuisance through noise or odours, and without adversely affecting the countryside or places of special interest. It further introduces a hierarchy of how to manage waste with the top priority of preventing waste via preparing for reuse, recycling, recovery and finally disposal.

The Packaging and Packaging Waste Directive (Directive 94/62/EC), which has been amended lately regarding lightweight plastic carrier bags (Directive (EU) 2015/720), also plays a role with regards to the topic. In its original version, it defines “organic recycling” as one means to reduce the negative impacts of packaging on the environment. In the latest amendment, a clearer distinction between oxo-degradable, biodegradable and compostable is discussed, at least with regards to specifications and labelling.

In recent years the Circular Economy Package of the European Commission revised and complemented the legislative framework on waste. The implementation of Directive (EU) 2019/904 on the reduction of impacts of certain plastic products on the environment (Single-Use Plastics Directive) is important because it opens the field for the introduction of biobased and truly biodegradable plastics as one option to solve the issue of increasing accumulation of plastics and micro-plastics in the (marine) environment. For NoAW domain this Directive is highly relevant because it highlights the need for new, innovative solutions. One of the main focuses of the NoAW project is the production of poly-hydroxy-alkanoates

(PHA), precursors of the biodegradable plastics based on agricultural waste such as livestock manure and crops silages, which is fully in line with the formulations in this new Directive.

#### 4.4.2 EU Agricultural & Fertiliser Regulation

Anaerobic digestion usually yields a digestate that is used as fertilizer in agriculture and hence fertilizer-related legislation has to be considered. Since fertilizers influence surface and groundwater bodies, fertilizer and water-related legislation are interlinked.

To protect (ground)water bodies against pollution caused by nitrates and phosphate on surface water bodies from agricultural sources, including digestate from anaerobic digestion or digestate products, the Nitrate Directive (Council Directive 91/676/EEC) promotes good farming practices, for example by limiting the periods and amount of applying nitrogen from organic fertilisers like livestock manure, by reducing nitrogen run-off or leachate through better fertiliser management on the farm level, by planting intercrops that « catch » nutrients outside the main crops vegetation period or before the main crop fully covers the soil or by storing manures over a longer period time. Solutions need to be found to extract and concentrate nutrients from livestock manure in areas where excess nutrient levels pose a risk for the water bodies. By doing so the nutrients become worthwhile transporting them over long distances into regions or sectors where they are needed. Additionally, methods of fertilising near the plants nutrient demand during the vegetation period need to be established and promoted. NoAW addresses this topic as described above for the Groundwater Directive by assessing precision fertilising using Near-infrared Spectroscopy and GPS.

The Fertiliser Directive (Regulation (EC) No 2003/2003) aims at removing trade barriers between member states for mineral fertilisers and thus creating an internal fertiliser market. Due to its focus on mineral fertilisers it, however, only covers about 50% of all fertilisers and excludes all fertilisers and fertilising products made from organic materials (e.g. livestock manures, organic wastes, agricultural by-products). Organic materials offer the opportunity for sourcing nutrients like phosphate and nitrogen locally and thus contribute not only to better waste and nutrient management, but also to reducing dependency from external sources, to reduce greenhouse gas emissions and to strengthen the circular economy. Within the Circular Economy Package, the Commission reflected on this situation and presented a draft proposal for a new Fertiliser Products Regulation in COM 2016/157/EC in 2016. Along with this are amendments in Regulations (EC) No. 1069/2009 and (EC) No 1107/2009. This is for example relevant with regards to biochar products, which have also been part of NoAW scenario.

For organic farming, the EU-Eco-Directive (Council Regulation (EEC) No. 834/2007) on organic production and labelling of organic products defines how agricultural products and food labelled as organic products have to be grown. This includes regulations on suitable fertilisers and the use of livestock manures and resulting digestates from anaerobic digestion in organic farming. In general the EU-Eco-regulation is very open towards the use of digestate as fertiliser, even if feedstock does not come from organic farms. The only limitation it makes is that livestock manure from conventional farms may only be used, if it comes from non-industrial and area bound animal husbandry. It stipulates a minimum standard that – at least in Germany – is surpassed by most organic farming labels.

### EU Fertilising Products Regulation (EU 1009/2019)

The new EU Fertilising Products Regulation (EU 1009/2019) providing harmonised conditions for making fertilisers made from such recycled or organic materials available on the entire internal market should be established in order to provide an important incentive for their further use. Promoting increased use of recycled nutrients would further aid the development of the circular economy and allow a more resource-efficient general use of nutrients. The aim is to reduce the EU dependency on nutrients from third countries, most importantly the replacement of the Cadmium and Uranium contaminated chemo-synthetic mineral phosphate fertilisers targeted. The EU 1009/2019 scope of the full harmonisation; which will be implemented from July 16, 2022; extended to include recycled and organic materials. Already in 2022, the primary food production sector has to meet future policy changes: most importantly the new EU Fertilising Product Regulation functionality specifications.

The European Commission envisages a replacement of the currently valid Regulation (EC) No 2003/2003, expanding its scope to secondary raw material based, i.e. recovered and bio-based fertilising products. A new EU Fertilising Products Regulation (EU) 2019/1009 was approved by the European Parliament and the Council of the European Union on 5 June 2019.

The new (EU) 1009/2019 Regulation is repealing (EC) No 2003/2003 by July 16, 2022, and shall enter into force on the twentieth day following that of its publication in the Official Journal of the European Union. This Regulation shall apply from 16 July 2022 and shall be binding in its entirety and directly applicable in all Member States. The Regulation (EC) No 2003/2003 will be replaced by the new Regulation by July 16, 2022.

The existing EU rules do not affect the so-called 'national fertilisers' placed on the market of the Member States in accordance with national legislation. Some Member States have very detailed national rules whereas others do not. Producers can choose to market a fertiliser as 'EC fertiliser' or as 'national fertilisers'.

#### **The key elements of the new and bioeconomy driven Agri fertilizer product rules are:**

- Opening the Single Market for bio-based fertilisers: The agreement on the Fertilising Products Regulation will open the market for new and innovative organic fertilisers by defining the conditions under which these can access the EU Single Market.
- Rules on safety and quality: The new Regulation will provide strict rules on safety, quality and labelling requirements for all fertilisers to be traded freely across the EU. Producers will need to demonstrate that their products meet those requirements before affixing the CE mark.
- EU fertilising products divided into different product function categories (PFC), which should each be subject to specific safety and quality requirements adapted to their different intended uses.
- Component materials for EU fertilising products divided into different categories, which should each be subject to specific process requirements and control mechanisms. It should be possible to make available on the market an EU fertilising product composed of several component materials from various component material categories, where each material complies with the requirements of the category to which the material belongs.
- Introducing new limit values for contaminants in fertilisers.

This project has received funding from the European Union's Horizon 2020 research and innovation programme under grant agreement No 688338

Table 1: Type of fertiliser and the maximum limit of Cadmium

Type of fertiliser	Maximum Cadmium limit
Organic fertilisers, inorganic soil improver and other bio-fertilisers	1.5 mg/kg dry matter
Organic soil improver and liming materials	2 mg/kg dry matter
Inorganic macronutrient and organo-mineral fertilisers less than <5% P <sub>2</sub> O <sub>5</sub> content by mass	3 mg/kg dry matter
Inorganic macronutrient and organo-mineral fertilisers above >5% P <sub>2</sub> O <sub>5</sub> content by mass ('phosphate fertiliser').	60 mg/kg phosphorus pentoxide (P <sub>2</sub> O <sub>5</sub> )
Low cadmium content organo-mineral fertilisers	20 mg/kg phosphorus pentoxide (P <sub>2</sub> O <sub>5</sub> )
Inorganic micronutrient fertilisers	200 mg/ kg total micronutrient content

- Contrary to most other product harmonisation measures in Union law, Regulation (EC) No 2003/2003 does not prevent non-harmonised fertilisers from being made available on the internal market in accordance with national law.
  - Compliance with harmonised rules should, therefore, remain optional, and should be required only for products, intended to provide plants with nutrient or improve plants' nutrition efficiency, which are CE marked when made available on the market. This Regulation should therefore not apply to products which are not CE marked when made available on the market.

The new EU regulation content is demonstrated in practice through the NUTRIMAN Nitrogen and Phosphorus recovery thematic network, which ensures that when the new EU Fertilising Products Regulation law harmonization is reaching implementation status by 2022, the agricultural practitioners already know, have tried and are applying such recovered products in practice (<https://nutriman.net/farmer-platform>).

**EU Critical Raw Materials (COM (2017) 490 final)**

Disrupted nutrient recycling is a problem for Europe and all over the world. Phosphorus and nitrogen are lost across environmental media during food production or are wasted instead of being used for plant nutrition (European Commission, 2016b). Reserves of the phosphate rock used to make such fertilizers are finite, and concerns have been raised that they are in danger of exhaustion. For long term global food security is the sustainable supply of Phosphorus, a key resource for soil fertilisation that

cannot be substituted (European Commission, 2011a). One of the main fertiliser constituents is chemically processed phosphate rock, which has been identified by the Commission as a critical raw material. For phosphate fertilisers, the EU is currently highly dependent on import of phosphate rock mined outside of the EU (European Commission, 2016a). Concentration of phosphorus mines outside the EU makes the EU fertilising product industry and the European society dependent and vulnerable on imports, high prices of raw materials as well as the political situation in supplying countries. (European Commission, 2016b). High risk element is also that the mined and chemosynthetically processed mineral phosphate rock containing various levels of toxic cadmium and uranium contaminations (Smidt, 2011) (Schung E, 2013). The fragmentation of the non-harmonised part of the market is seriously hindering trade opportunities (European Commission, 2016c).

Phosphorus-containing mineral fertilisers are produced from toxic Cadmium and Uranium contaminated mineral phosphate deposits. Currently, a 20% efficiency of phosphorus (P) use along the mine-to-fork pathway is calculated, giving room for improvement along each step of the process. Therefore, Phosphorous recycling is one of the key priorities of the sustainable agricultural systems to replace mineral phosphate. Trends and developments on the global phosphate rock market are putting the EU's security of supply of phosphate rock under increasing pressure. (de Ridder M., 2012).

#### **4.4.3 EU legislation on Food Contact Materials**

Biobased plastics and polyphenols extracted from agricultural by-products might come into contact with food. For this reason, the EU legislation on Food Contact Materials (FCM) applies. The framework is set by the Commission Regulation (EC) No 1935/2004. For plastic materials and articles with food contact, the rules are specified in the Commission Regulation (EU) No 10/2011 (Plastics Implementation Measure). The latter describes rules on the composition of plastic FCMs and establishes a Union list of materials that are permitted for use in the manufacturing of plastic FCMs. The Regulation also describes restrictions on the use of the listed substances and provides rules to determine, whether or not plastic materials and article comply with the Regulation.

The Regulation uses „migration limits” to ensure the safety of plastic FCMs. Two migration limits exist: Specific Migration Limits (SML) and the Overall Migration Limit (OML). The SMLs are based on the toxicity of each specific substance on the Union list. Since a plastic FCM does not only consist of one substance, the OML restricts the overall migration to a food from all substances together to 60 mg/kg food, or 10 mg/dm<sup>2</sup> of food contact area.

Strong emphasis is put on documentation to ensure the safety and compliance of plastic materials. Therefore, adequate data has to be provided – meaning communicated – throughout the production chain up to but excluding the retail stage via a „Declaration of Compliance” (DoC).

This regulation is being amended regularly based on the findings and scientific opinions published by the European Food Safety Authority (EFSA). A compilation of all amendments can be found online at [https://ec.europa.eu/food/safety/chemical\\_safety/food\\_contact\\_materials/legislation\\_en](https://ec.europa.eu/food/safety/chemical_safety/food_contact_materials/legislation_en) (last visited 22 October 2019).

#### **4.5 Concluding remark**

Above an overview of applicable legislation for the NoAW domain was presented. Apparently, the subject is highly topical. The relevancy of practices from amongst other NoAW practices is elaborated in the following chapters.



## 5 Best practices and methods for agricultural waste valorisation

### 5.1 Overview of the main possibilities of agricultural waste valorisation routes

#### Valorisation of manure as feedstock biogas production

Manure produced by intensive livestock rearing systems contains excess of nutrients and organic matter. Manure, similarly to other agricultural residues, is destined to be used as feedstock in biogas plants, especially if manure or slurry results from large animal number in intensive farming. The biogas plant is a proven technology, it is a ready part of the agricultural sector, but it needs to be improved to be more efficient. The 2-steps anaerobic digestion provides valuable materials besides the biogas. Moreover, we can use microbial cells to upgrade biogas to have biomethane. This can be used in the automotive sector or injected into the gas network.

#### Valorisation of straw

Straw potential can be used as a renewable energy source. However, not the whole straw potential is collectable, because there are existing competitive uses, which are limiting the whole collectable straw potential: the major one is the animal bedding (cattle and chickens). The crop protection (for the protection of sensitive vegetables during winter against frost when they are left in the ground), or mushroom growing industry (where wheat straw is used to provide a composted medium), or paper pulping, etc. are also limiting factors.

Taking into account the wheat straw already used for animal feeding/breeding and soil maintenance, about 60% of the world production is still available for energy production purposes (varying from the geographical localization), missing clearly of valorisation outputs (Kim and Dale, 2004).

Second-generation biofuels are produced from lignocellulosic crops, such as fast-growing trees and permanent grasses or from straw residues. As stated by researchers (Rouches et al., 2016), could be reached a significant increase in methane production from wheat straw basis when the straw was pre-treated with white-rot fungi. Wheat straw is also suitable for biorefinery approach.

PHA is an important polymer family that has been in the development stage for a while but to finally enter the commercial market at of which production capacities are estimated to quadruple in the next five years (Chen et al., 2016; Briassoulis and Giannoulis, 2018). It has been proven to have great potential as a substitute for traditional plastics due to its biodegradability. Agro-industry waste has been investigated as a low-cost substrate for polyhydroxyalkanoates (PHAs) production. Organic waste may be subjected to anaerobic fermentation or hydrothermal treatment to produce organic acid rich solutions. The volatile fatty acid (VFA) rich liquors are an ideal feedstock for PHA production.

The research activities are intensive on the production of polyhydroxyalkanoates using straw as cheap substrate: PHAs are polyesters of natural origin accumulated in form of intracellular granules by a wide variety of bacterial strains. Due to these R+D activities, the industrial production of polyhydroxyalkanoates used straw as a cheap carbon source is getting closer.

#### Valorisation of winery waste towards bio-materials

About 55 million tonnes of vegetable waste has been produced in Europe in 2016 (Eurostat, Generation of waste by waste category, hazardousness and NACE Rev. 2 activity, 2019). This large amount of agro-waste does not yet find a valuable exploitation, due to the difficulties connected to the management

of a so large amount of waste and the poor diffusion of the idea that vegetal waste can contain high-value resources.

Grape growing and winemaking activities generate wastes, aside from the wine. Vine shoots, grape stalks, and wine pomace are not properly exploited although they are rich in lignocellulosic fibres and high-value molecules, such as polyphenols.

Lignocellulosic materials, such as vine shoots and stalks, constitute a significant vegetal waste in terms of amount. Moreover, from the winery industry, the main solid organic waste is grape pomace. The amount of pomace generated depends on the grape cultivar, the pressing and fermentation processes. However, studies have shown that pomace represents about the 20-30% of the original grape weight. Grape pomace as a potential source of many valuable healthy and technological compounds, which can be applied by different industries like food and feed production, pharmaceutical and cosmetic industry, etc..

The main components of pomace are seeds, stems, residual pulp and skin: all contain a significant amount of bioactive compounds, such as phenols, and fibres. Indeed, it is reported that about 70% of phenolic content is retained in grape pomace after wine processing.

The difficulties encountered in a real exploitation of the grape pomace can be identified in a not controlled composition, that depends on the grape variety, location, fertilization conditions, soil and harvest period. Therefore, a better knowledge of the grape pomace composition should be useful for future industrial applications.

For example, polyphenols contained in grape pomace could be better exploitable as bio-active molecules. The conventional methods used to extract phenols from grape pomace are based on the use of solvent, more specifically a mixture of solvent and water. Other not traditional techniques have been also investigated mainly at lab scale. In any case, the extraction procedures do not find yet a large development at the industrial scale.



## 5.2 Biomaterials, bioplastics: Summary of bioplastics, production of PLA, PHAs (PHB, PHV) and their uses, cellulosic materials, starch, etc.

Nowadays, the worldwide production of plastic is about 335 million tonnes per year with bioplastics accounting only for approximately one percent of the total production (European Bioplastics, 2019.). However, bioplastics market is estimated to continuously increase due to the great interest that they are attracting over the last years. Bioplastics are not a single material, but a family of materials with different properties. According to European Bioplastics (European Bioplastics, 2019.), a bioplastic is a biobased or a biodegradable material or a plastic material with both features. The term *biobased* means that plastics are derived from renewable resources whereas *biodegradable* indicates the property of a material to be degraded into natural substances (such as water, carbon dioxide, methane and compost) by means of microorganisms available in the environment. This property strictly depends on the chemical structure of plastics and it is not related to the source feedstock a completely biobased material may be non-biodegradable whereas a biodegradable plastic can be of fossil origin. Figure 9 represents the three different types of bioplastics.

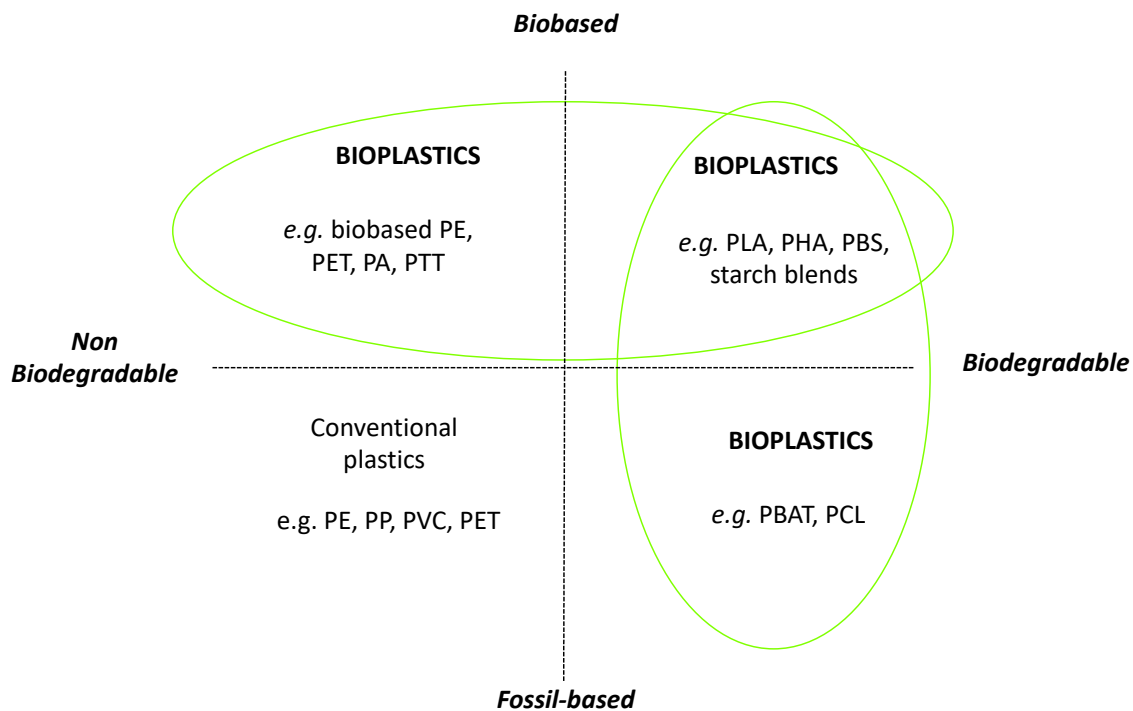

Figure 9: Classification of bioplastics (European Bioplastics, 2019.)

A small group of bioplastics comprises materials that are based on fossil resources but are biodegradable, such as the copolymer polybutylene adipate terephthalate (PBAT) or polycaprolactone (PCL), that is a polyester. These materials are typically used in combination with other bioplastics in order to increase their biodegradability. Technologies to make these bioplastics at least partially bio-based are being developed.

Another family is made of commodity plastics that are biobased but non-biodegradable, such as biobased polyethylene (PE), polypropylene (PP), polyethylene terephthalate (PET), polyamides (PA), polytrimethylene terephthalate (PTT). These petroleum-free materials, besides limiting the consumption of fossil fuels, allow reducing greenhouse gas emissions and their properties are identical to petrochemical derivatives. Currently, the most commonly used feedstock is bioethanol, that is typically obtained from the fermentation of sugarcane or sugar beets or by hydrolysed starch deriving from corn grains or from other crops, such as potatoes and wheat. However, since the production of this bioethanol (referred to as “first-generation” ethanol) competes with food production, there is a huge attention towards the development of the “second-generation” ethanol, produced from lignocellulosic biomass, that is the most abundant carbohydrates source and includes agricultural wastes, wood, and grasses. Among this group of bioplastics, bio-PE is being produced on a large scale since, in general, polyethylene accounts for more than 30% of the global plastics market.

Both bio-based and biodegradable properties belong to the third family of bioplastics which mainly include starch blends made of thermo-plastically modified starch or polyesters like polybutylene succinate (PBS), polylactic acid (PLA) and polyhydroxyalkanoates (PHA).

PBS derives from poly-condensation of succinic acid and 1-4 butanediol. It was exclusively derived from fossil sources in the past, but now it can be completely biobased and its market is expected to increase.

As for PLA, in 2016 it was among the most utilized bioplastics in the world. PLA is obtained from lactic acid (LA) and converted back into its monomer when hydrolytically degraded. LA is a naturally occurring organic acid traditionally produced by fermentation of sugars obtained from renewable resources, such as agricultural waste straws, dairy waste, algal biomass, food waste. PLA presents several distinct forms due to the chiral nature of lactic acid and, therefore, it is a very versatile material with attractive mechanical and physical properties, including excellent barrier properties. This makes PLA a suitable candidate for several demanding applications including film and packaging materials, textile and fibres, construction and automotive products. Also, thanks to its biocompatibility (due to the fact that can be assimilated by a biological system) and non-toxic features, PLA can be adopted for biomedical applications such as drug delivery, blood vessels and tissue engineering.

PHA is among the main drivers of the growth of bioplastics, mainly due to the fact that PHA is not a single polymer, but a family of copolymers which feature a wide array of physical and mechanical properties depending on the length and composition of the side chains. The chemical structure of PHA is reported in Figure 10.

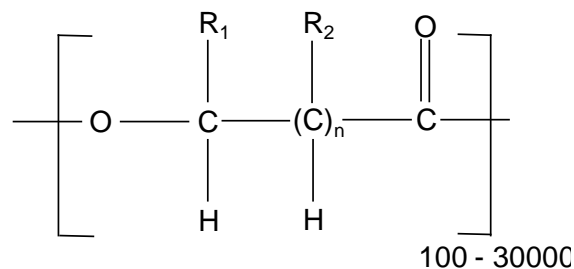

Figure 10: PHA chemical structure. R1 and R2 represent variable hydrocarbon side chains; n represents the number of carbon atoms in the linear polyester structure

The most promising PHA is the poly(hydroxybutyrate-hydroxyvalerate) copolymer, P(HB-HV), with properties similar to polypropylene but completely biodegradable in the environment under both aerobic and anaerobic conditions. These polyesters are synthesized by over 300 different species of microorganisms

as insoluble granules in the cell cytoplasm that function as an internal source of carbon and energy for microbial metabolism. PHA can be obtained from a large range of available organic feedstock, including industrial and agricultural wastes, food waste, animal waste, and molasses, provided that a preliminary acidogenic fermentation (AF) process is performed. The final PHA composition also depends on the composition of the mixture of acids deriving from AF, that is primarily affected by the feedstock nature. As a consequence, PHA can be used for a broad portfolio of market applications, including packaging, heat-sensitive adhesives, disposable utensils, agricultural films, bulk commodity plastics, as well as medical applications such as drug delivery. However, a large commercialization of PHA is mainly limited by their high production cost mainly due to the use of pure microbial cultures. The development of innovative and robust technologies that imply mixed microbial cultures makes it possible to estimate a rapid increase in the PHA market in the next future.

It is worth of mentioning that PHA is 3-times biopolymers, because besides being biobased and biodegradable, they are also biologically synthesized. These properties offer specific advantages for their use in agriculture and horticulture. The use of plastics in these sectors has steadily expanded in the last 50 years and an attractive application is the production of mulching films. Indeed, farming practices require the use of large quantities of plastic mulching films that are used to create a favourable microclimate at the zone of the plant roots growth by modifying soil temperature, preventing moisture loss, retaining nutrients, and limiting/suppressing weed growth. Due to their excellent properties, these films have a positive impact on agriculture because improve crop yields and allow producing earlier crops and minimizing the use of pesticides. However, the majority of mulching films are made of non-biodegradable plastics and cannot be naturally degraded in the land environment, and their use likely leads to a gradual increase of plastic fragments in the soil. Therefore, they are removed after each growing season, generating thousands of tons of agricultural plastic wastes each year. Only a small fraction of plastic films is recycled since recycling is complicated (due to a high contamination with soil) and expensive. In many cases, large quantities of agricultural plastic waste are disposed in the fields or landfills or burnt by the farmers, releasing toxic or harmful substances, and possibly affecting food safety. This creates serious problems of waste management and negative environmental effects, that can be solved by using mulching films made of biodegradable plastics. These can be incorporated into the soil at the end of the crop season undergoing biodegradation by soil microorganisms. Mulching films based on bioplastics provides similar benefits to plastic-based films with no significant differences in crop yields, and it has been reported that about 200 days after the incorporation of a biodegradable film into the soil, the concentration of its residues can be very small. Presently, most commercially available biodegradable mulching films are based on polysaccharides such as cellulose and starch blends but a variety of biodegradable plastics can be used and, in this context, PLA and PHA (that are both biodegradable and biobased) represent a real challenge for enhancing sustainable and environmentally friendly agricultural activities.

Other examples of bioplastic applications in agriculture and horticulture sectors are the production of films for banana bushes (to be protected from dust and environmental factors) or plant pots. The use of biodegradable plastics for pot-plant marketing is particularly interesting because it allows to directly put in the soil herbs, plants or flowers with their pots. The latter can disperse in the soil without negative environmental impacts while plants growth can occur. An appropriate example is Poinsettia, that is a winter ornamental pot-plant whose demand is concentrated in the Christmas period. A large quantity of plastic pots for Poinsettia is produced per year becoming a waste at the end of their utilization. The possibility to replace conventional plastics with biodegradable plastics creates a good and sustainable solution to this environmental problem.

Finally, the largest market area of bioplastics is the packaging sector with particular reference to the food packaging industry. The requirements for food packaging are as various as different are the types of food. As an example, flexible packaging solutions (e.g. films and trays) are suitable for fresh products, such as fruits and vegetables, but are inadequate for shelf-life food. Even though bioplastic packaging

materials feature as existing conventional plastic packaging materials in terms of food protection and self-life food prolongation, there is the need to improve their antimicrobial and barrier properties, which include gaseous (e.g. water vapour, oxygen and carbon dioxide) permeability. In this context, innovative bioplastic-based materials for food packaging are being studied in the frame of the NoAW project which involve the production of composite materials made of PHA and fibres or PHA and polyphenols, that are known to possess antimicrobial activities.

### NoAW progresses

The first class of materials that can be obtained by starting from agro-waste are bacterial polymers, specifically poly(hydroxy alkananoate)s (PHAs). In NoAW the production of PHAs is developed by starting from Volatile Fatty Acids (VFA), produced by two-step anaerobic fermentation.

In particular, a research activity concerns the production of PHAs converting VFAs by an innovative system that uses a mixed culture of photosynthetic organisms. In this way, solar energy will be the only source of energy and it will be possible to decrease the final cost of the material.

The PHA materials not only are fully bio-based materials, produced by microorganisms, but also are fully biodegradable, including in seawater, therefore they can contribute to the decrement of the environmental plastic pollution.

Moreover, NoAW contributes to developing new strategical routes towards the valorisation of winery waste for the production of a series of materials, as shown in Figure 11, and, more in detail in Figure 12.

Here a sequence of different activities that can be developed:

- vine shoots and grape pomaces can be milled and the obtained powders can be directly added to a polymeric matrix using a melt-mixing procedure at high temperature to produce biocomposites;
- in parallel bioactive molecules can be extracted from winery waste: a mixture of polyphenols, tannins, some specific molecules, for example, vanillic acid, if present in a sufficient amount can be obtained. Two extraction procedures (solvent and pressurized liquid extractions) have been optimized starting from two different kinds of grape pomaces. The most promising extraction technique (solvent extraction) has been selected through an evaluation by its environmental and cost impacts and will be scaled up. In this way, it will be possible to solve some problems concerning the scaling up at pre-industrial scale of the extraction procedures.

The mixture of polyphenols can be used as antioxidant additives for polymers. In this way, an active packaging, with intrinsic antioxidant properties, by exploiting natural polyphenols extracted from grape pomace can be produced.

- Tannins can be used as building blocks to obtain new bio-based polymeric resins. Vanillic acid (or similar difunctional molecules) can be used to prepare new bio-based polymers and copolymers, such as PET-like (co)-polyesters.
- Finally, the residues of extraction are added to a polymeric matrix to prepare new biocomposites.

The biocomposites, prepared by using the bacterial PHAs as a matrix (Vannini, 2019, Celli 2018), have the advantages:

- to be 100% bio-based;
- to be biodegradable;
- to decrease the cost of the polymeric matrix, maintaining the final mechanical properties;

- to probably have improved performances, for example in terms of antioxidant properties.

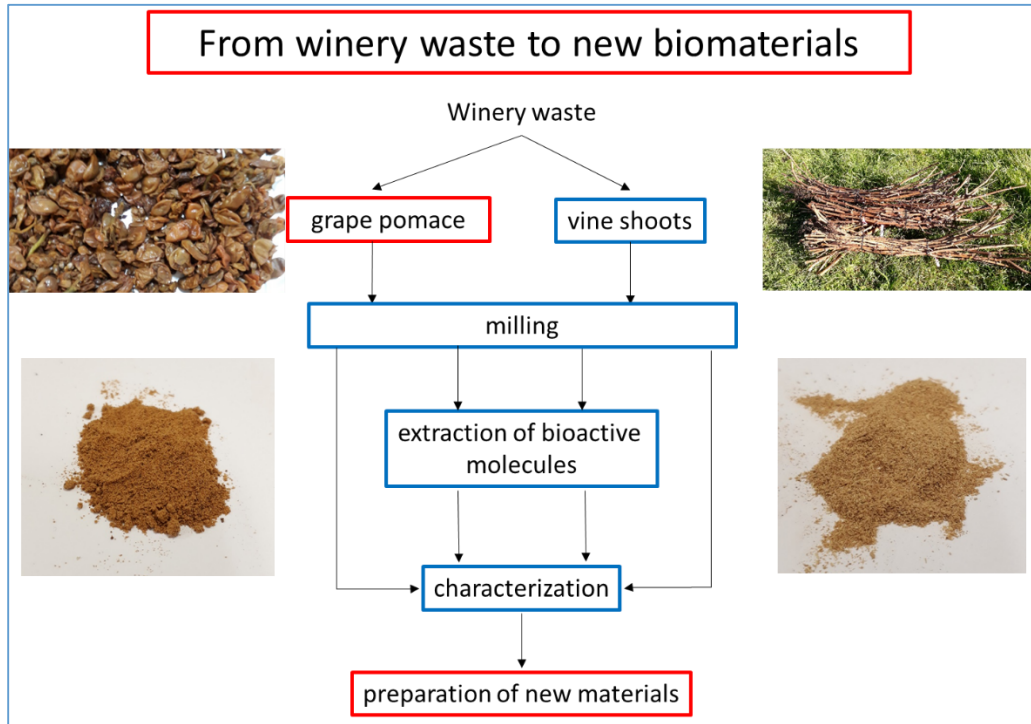

Figure 11: Activities developed in NoAW to valorize winery waste

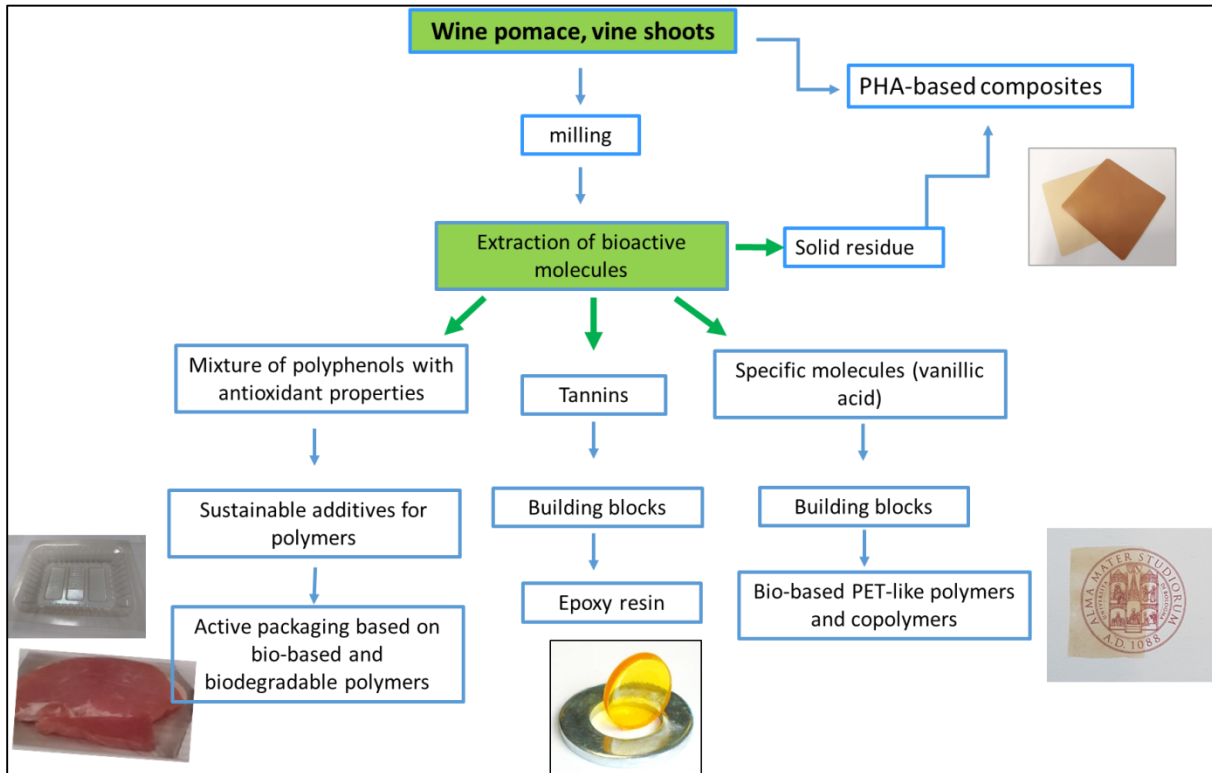

Figure 12: Activities developed in NoAW correlated to the extraction of bioactive molecules from winery

Finally, agricultural waste can be exploited

- to produce monomers for polymer synthesis: a mixture of fruit and vegetal waste can be used to produce succinic acid by fermentation.
- to extract different active molecules, according to the composition: for example, proteins and pectin can be extracted from potato processing waste.



### 5.3 Biogas production and bioenergy

Bioenergy is a form of renewable energy that derives from organic material. In this context organic matter refers to biomass, e.g. wood, straw, manure, agricultural products and by-products as well as the organic fraction of municipal solid waste, catering waste and residues from the food processing industry. The processes to convert organic matter into energy can be physical, chemical, thermal, biological or a combination of those.

Biogas production via anaerobic digestion is one way of converting organic matter into bioenergy. It is a biological process in which consortia of microorganisms convert organic matter into biogas and fertiliser. Suitable feedstock for this process is any type of “soft” biomass, meaning that it is poor in lignin and celluloses. Cellulosic feedstock like straw needs special pre-treatment before it can be added to the digester. Anaerobic digestion takes place in digesters which aim at providing ideal conditions for the microorganisms. The produced biogas is a mix of methane, carbon dioxide with traces of hydrogen sulphide and ammonia.

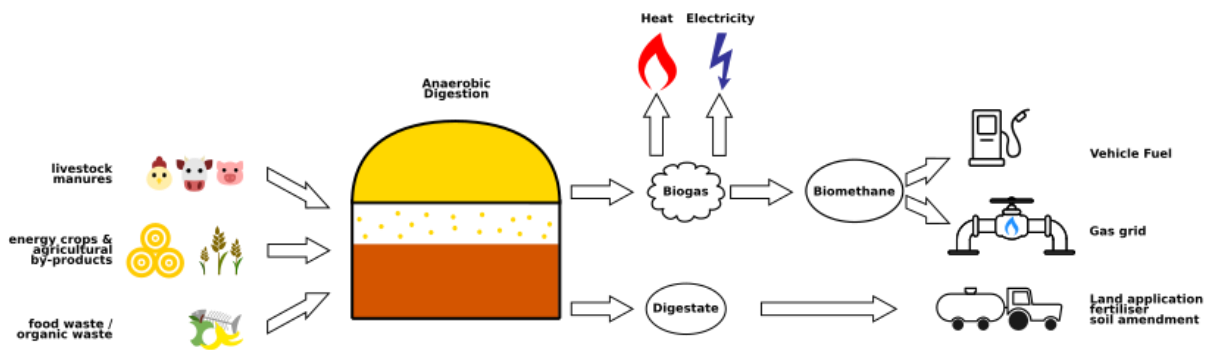

Figure 13: Traditional Flow streams on biogas plants

This gas can be used in a variety of ways (see Figure 13). It is usually burned in a combined heat and power unit (CHP), also called cogeneration unit, and the generated electricity is fed into the public grid. The biogas plants' own electricity requirements can be met either from the power grid or directly from the CHP unit. In addition to electricity, CHP operation also produces heat. Part of the waste heat generated during this process is used to heat the fermenters. Depending on the size of the biogas plant, however, most of the heat generated is available for other uses, for example, to supply heat to a district heating grid or directly to industrial enterprises.

The amount of power and heat produced by one CHP depends on its electrical and thermal efficiency. As a rule of thumb, the electric efficiency increases with size, while the thermal efficiency decreases with size. Nevertheless, variations are possible depending on the supplier and the CHP model. Table 2 shows a range of CHP sizes with typical electric and thermal efficiencies.

Table 2: Typical electric and thermal efficiencies of CHPs

	50 kW	75 kW	160 kW	250 kW	550 kW	1 MW	2,2 MW
El. efficiency	35 %	38 %	41 %	42 %	42 %	41 %	43 %
Therm. efficiency	50 %	43 %	40 %	42 %	43 %	45 %	41 %
Total	85 %	81 %	81 %	84 %	85 %	86 %	85 %

However, one big problem for thermal efficiency is after the CHP : Grid loss and different need of heat over the year.

This project has received funding from the European Union’s Horizon 2020 research and innovation programme under grant agreement No 688338

Biogas can also be used in boilers to generate low temperatures for heating and drying systems or for steam generation. The prerequisite is that the biogas quality meets the requirements of the boiler. Alternatively, the biogas can be upgraded to biomethane by separating the CO<sub>2</sub> and thus be used as a natural gas substitute.

Apart from biogas, the digested feedstock which is called digestate leaves the process. This digestate still contains the largest part of the nutrients that have entered the digester with the feedstock. Apart from the macro-nutrients nitrogen, phosphorus and potassium, digestate contains organic matter for humus production and possibly also heavy metals as well as organic pollutants. The latter is found in digestate from the digestion of organic household waste, fat and grease as well as catering waste. Heavy metals might come from animal feed, especially in pig husbandry.

The digestates' nutrient content depends on the feedstock composition, their nutrient content and the fermentation conditions. During anaerobic digestion, the readily degradable organic matter is degraded, leaving behind mainly a more difficult to degrade, relatively stable organic matter, which will eventually convert into humus. Humic matter contributes to soil aggregate stability and thus also to the soils' capability of retaining water and nutrients.

In the digestate nitrogen is present in an organically bound and a dissolved form. During anaerobic digestion up to 80% of the nitrogen is converted into ammonium (NH<sub>4</sub>-N) which is the dissolved form. In its dissolved form nitrogen is readily plant available and therefore has the same fertilising properties as mineral nitrogen fertiliser. The organically bound nitrogen, on the other hand, remains in the soil and will only become plant available after further degradation of the organic matter which might take some years to happen.

Digestate usually has a pH-value of around 8 or even slightly higher. In combination with the ammonium, this bears the risk of losing nitrogen in the form of ammonia. One consequence is a reduced fertilising effect, another consequence is high emissions. Therefore, it is important to apply digestate close to the plants' demand and to immediately work it into the soil when land-spreading it – e.g. by using trail hose or trail shoe technology.

Apart from nitrogen, the digestate contains phosphate and potassium in a form that is easily plant available as well as sulphur. Because of the nutrients and the organic matter, digestate serves as fertiliser and also as a soil conditioner.

A conventional agricultural biogas plant with a 500 kW<sub>el</sub> CHP produces approx. 100 t/a of nitrogen. Considering a maximum allowed nitrogen placement of 170 kg/(ha\*a) a total area of 588 ha is needed to spread all the digestate. In areas where biogas plants meet a high number of animal heads the totally needed area might not be available thus creating local nutrient surpluses. In that case, digestate needs to be transported – often over long distances – to other sectors or regions. Alternatively, digestate processing allows to recover nutrients in a very concentrated form that can also be marketed.

### 5.3.1 Biogas in the context of Bioeconomy

Biogas plants have the potential to play a significant role in bioeconomy and by doing so to widen the range of services for generating income.

First of all biogas plants can digest a wide range of organic residues coming from various sectors, e.g. agriculture (manures, straw, intermediate crops), viticulture (grape pomace), horticulture (fruit pomace) and food-processing industries. Depending on the lignin and celluloses content a special pre-treatment might be needed to make the cells' content available for the microorganisms. This can either be physical processes like pressure and heat treatment or enzymatic processes. By using organic residues, biogas production is part of the circular economy in agriculture.



Secondly, the digestion process itself yields different types of intermediate products which are of interest for the creation of building blocks for further application. This is because of the wide range of microorganisms present in the process. They complement and partly depend on each other. Whilst the traditional biogas process relies on the complete degradation of volatile fatty acids (VFA) to acetic acid, hydrogen and carbonyl as shown in Figure 14, the process needs to be modified to produce longer chain fatty acids such as butyric acid which are interesting intermediates for the bioeconomy sector. Consequently, the production of biogas decreases, because the modification prevents a complete degradation of VFAs to acetic acid.

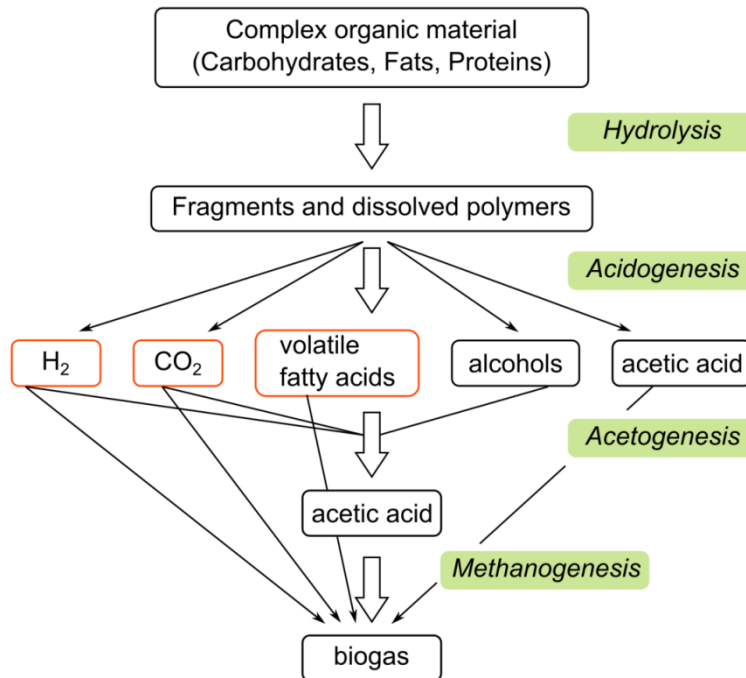

Figure 14: Degradation steps in anaerobic digestion

Thirdly, biological-technical interventions in the biogas process strive to increase the share of methane in the biogas up to a level that is comparable with natural gas or by producing hythane – a combination of hydrogen and methane.

When upgrading biogas to biomethane by removing CO<sub>2</sub>, this CO<sub>2</sub> can also be used for further applications, e.g. as dry ice. Research is currently trying to synthesize wax from CO<sub>2</sub>, e.g. for application in the cosmetics industry (A research project using Fischer-Tropsch process is running at Fraunhofer-Institut für Keramische Technologien und Systeme IKTS: [https://www.ikts.fraunhofer.de/de/blog/aus\\_co2\\_wird\\_wachs.html](https://www.ikts.fraunhofer.de/de/blog/aus_co2_wird_wachs.html) (German only), last visited 22 July 2019).

Finally, digestate as a fertiliser can be treated and upgraded in such a way that either conventional fertiliser products or new fertiliser products arise. In most of the projects, the aim is to concentrate nutrients and thus increase their transport worthiness. A very simple measure is the solid-liquid separation, which already leads to higher variability when fertilising. It also allows exporting the nutrients fixed in the solid form to another region. At the other end of the range are large plants that aim at extracting and concentrating specific nutrients – e.g. nitrogen or phosphorus. They use a combination of more sophisticated technologies. After recovering nutrients from the digestate, the remainder is a liquid that can also be used for irrigation purposes. A more detailed description of fertiliser production is given in chapter 5.4.

### 5.3.2 Biogas upgrading into biohythane at pilot scale

#### 5.3.2.1 Description of the pilot plant dedicated to biohythane ( $H_2+CH_4$ ) production

The pilot is composed of two anaerobic reactors in series as shown in Figure 15. The first reactor (22L) is dedicated to hydrogen production (acidogenic step). The retention time is ranging between a few hours to 1-2 days depending on the nature of the inlet and hydrogen performances. Pressure, pH and temperature are automatically regulated, and the reactor was mixed by magnetic stirring at 60 rpm. The temperature is regulated at 37°C or 55°C. The pressure is also regulated using two peristaltic pumps connected to a pressure sensor. Pumps are automatically activated when pressure is higher than the set value. An automatically controlled opening valve between the first and the second reactor allows transferring the effluent of fermentation into the second reactor for methane production. The second reactor, dedicated to methane production, has two compartments: one, at the top, treating wastewaters with microbial fixed beds, and the second, at the bottom, degrading the remaining solid residues after settling. This reactor presents a working volume of 358L, with a hydraulic retention time of 2-3 days for the liquid and a solid retention time as high as possible (>60-90 days).

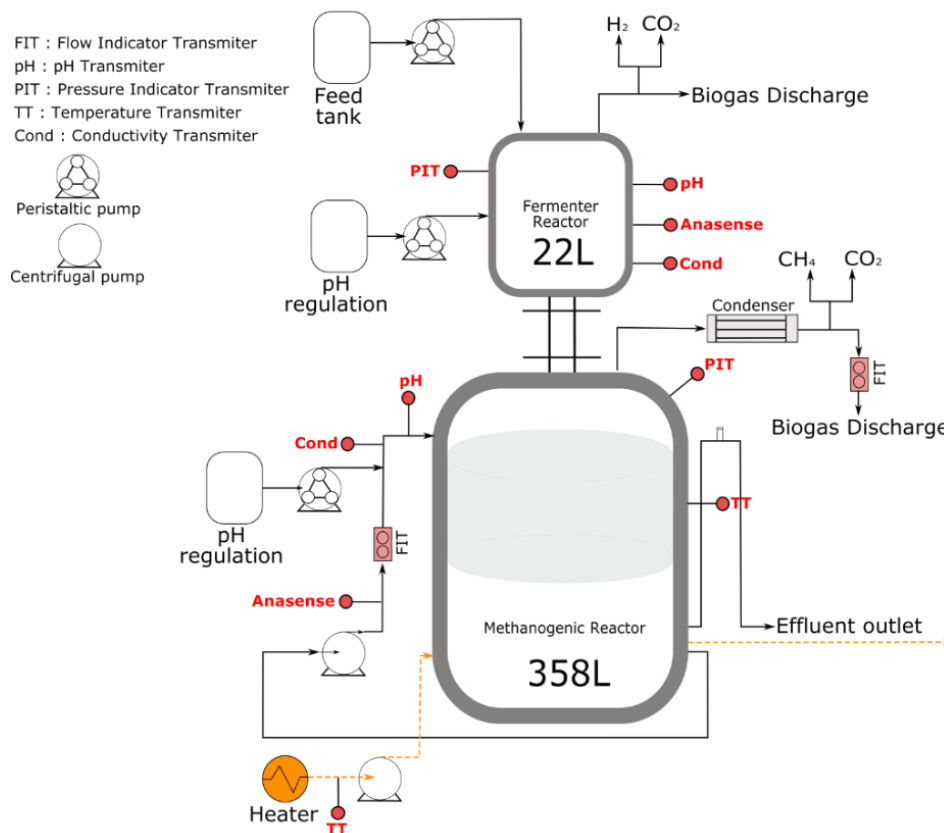

Figure 15: Fully automated two-stage process for biohydrogen and methane (biohythane) production with a feeding track specially designed for solid substrates

Biogas composition, as well as pH, temperature, conductivity, and redox, must be monitored online. Data are stored on a software called “SILEX” (Système d'Information pour l'EXpérimentation). Hydrogen production and VFAs concentration in the acidogenic reactor should be periodically determined by online GC-TCD, and manual analysis on GC-FID, respectively. Biogas productivity in the first reactor is measured using the working time of the calibrated peristaltic pump used for pressure regulation. The biogas productivity from the second reactor is measured using a Ritter meter and methane proportion is analysed using an infrared detector.

### 5.3.2.2 Preparation of the Inlet

The substrate (here wine distillery effluents and waste) should be used immediately or stored in a tank of 1 m<sup>3</sup> cooled at 5°C prior to feeding into the acidogenic reactor using a peristaltic pump (see Figure 16).



Figure 16: Vinasse storage tank

A mixture composed of vinasses and microbial inoculum (5% vol) must be preliminarily prepared and the pH adjusted to 6 using HCl (5M). The mixture can be then injected into the acidogenic reactor for hydrogen production using a peristaltic pump. The temperature in the first reactor should be kept at 37°C or 55°C, and the pressure set at 550 mBar. At the end of hydrogen production (2 to 4 days), the methanogenic reactor should be fed by the effluent of fermentation. Thereafter, 1/20<sup>th</sup> to the working volume, ie. 1 L of the effluent of fermentation is collected and used as inoculum to inoculate the next acidogenic cycle. The methanogenic reactor should be performed as a semi-continuous mode with a temperature regulated at 35°C and a pH at 7.5. The recirculation of the liquid phase is carried out using a pump working at 400 L/min to maintain the mixing within the reactor. The digestate (20L) can be collected each time the methanogenic reactor is fed by the effluent of fermentation.

### 5.3.2.3 *Special recommendations for running a two-step reactor system*

- Biohythane can be produced whatever the type of mixture of vinasses used as substrate. The full experiments showed that the mixture of vinasses used (concentrated and tartrate-poor vinasses) can produce biohythane whatever the ratio of vinasses.
- In order to reach a stable and robust biohythane production, we recommend using a temperature of 37°C, initial pH of 5.5, and regulated pressure at 550 mBar in the dark fermenter. These conditions enable to reach an energy recovery of  $3686 \pm 205$  kJ with a ratio of  $H_2/CH_4$  of  $23.3 \pm 4.7$  % per feeding. Moreover, with these conditions, a recirculation of the effluent in dark fermentation process without any treatment is feasible and reduces the cost of the process and the maintenance time (no inoculum treatment).
- If the objective is to produce a maximum of energy, the best performance was observed using 55°C and pH 7.0 in the dark fermenter reactor and reached an energy recovery of  $4906 \pm 926$  kJ with a ratio  $H_2/CH_4$  of  $8.9 \pm 2.1$  %. However, these conditions provoke a higher instability on hydrogen production due to the development of methanogens in the dark fermenter even though the inoculum is heat-treated before each dark fermentation. Thus, a maintenance of the process needs to be performed more frequently (*i.e.* cleaning the dark fermentation reactor) to operate the dark fermenter reactor at the optimal conditions and reach the best performances.
- The optimization of the acidogenic step enables the reduction of some pollutants, in particular nitrates. Interestingly, denitrification occurs during dark fermentation process but is involved in the consumption of the substrate which outcompetes the hydrogen production. We recommend (if denitrification is required) to operate the first acidogenic reactor at 55°C and at an initial pH of 7.5.

## 5.4 Organic fertilizer production and composting

Today organic matter is mainly being converted into organic fertilizer by applying either composting or anaerobic digestion possibly with post-treatment of the digestate. Composting and anaerobic digestion are completely different technologies for degrading organic matter. While anaerobic digestion is mainly suitable for treating the organic matter with a high water content, composting is used for treating the organic matter with a lower water content and higher shares of substances that are difficult to degrade, such as lignin. Figure 17 shows the suitability of wastes for composting or digestion depending on their water content and structure.

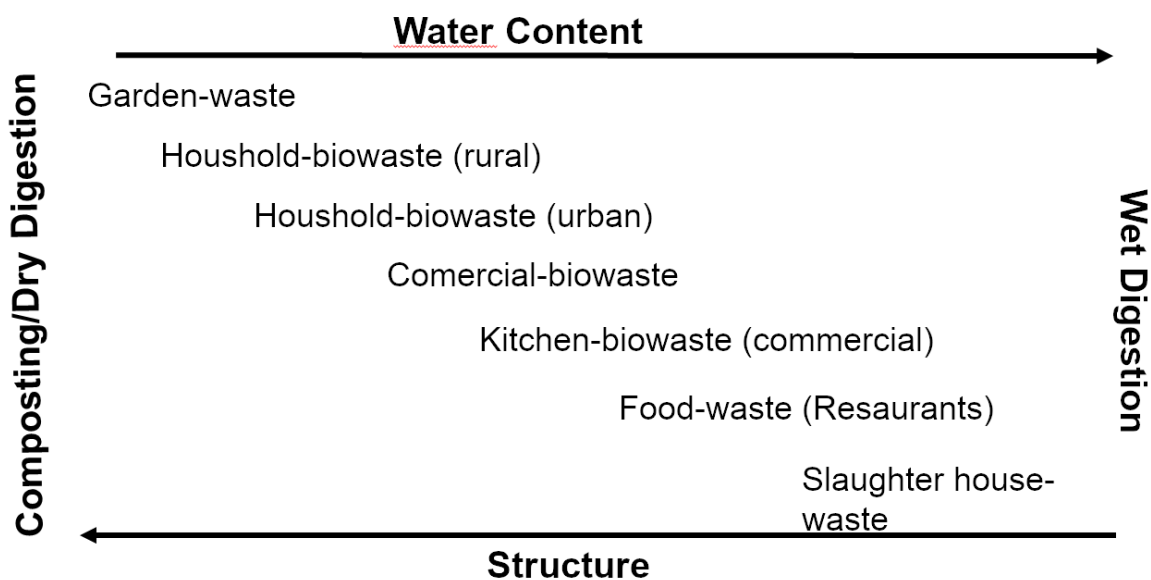

Figure 17: Suitability of organic matter for composting or anaerobic digestion depending on water content and structure

The main points distinguishing composting from anaerobic digestion are:

- the energy balance
- oxygen demand
- emissions
- odours
- technical complexity.

**Composting** is an aerobic process and needs a constant supply of air for optimal degradation of the organic matter. Therefore, it is important to provide a porous structure for the air to enter the composting heap and to maintain this during the whole process. Coarse material like green waste or branches help to create the needed pore volume. Composting depends on energy input, especially active ventilation during the main composting stage. During the actual process, the temperature inside the composting heap rises up to 70 °C, thus pasteurizing the material. After the process, the composted material serves as soil amendment and long-term fertiliser for example in agriculture. Most nutrients including nitrogen are bound to the organic matter. As a result, they are not readily available for the plants. Only about 5 %

This project has received funding from the European Union's Horizon 2020 research and innovation programme under grant agreement No 688338

of the total nitrogen content is available in the year of application the rest first needs to be mineralised before it becomes available to plants. Compost mainly contributes to increasing the soils nitrogen reserve. Additionally, the application of composting activates the soil organisms, improves soil structure, improves the soils air and water balance and finally improves the soils aggregate stability.

Composting plants range from simple systems with open windrow composting to completely closed composting plants with air treatment. Important aspects with composting are nutrient losses, odour and gas emissions that can go along with this technology. If, for example, ventilation is not sufficient, parts of the process become anaerobic which results in greenhouse gas and other emissions. Therefore, the application of best practices is crucial to maximising the benefits of composting.

**Anaerobic digestion** does not rely on air, but provides an environment free of air (anaerobic) for the processing of organic matter. While composting depends on energy input and energy dissipates in the form of heat, anaerobic digestion produces more energy than is needed to maintain the process. And while composting yields a solid product, digestate arises mainly in liquid form, though special digesters also yield a more solid digestate. Table 3 lists the main differences between composting and anaerobic digestion.

Table 3: Comparison between Composting and Anaerobic Digestion

	Composting	Anaerobic Digestion
<b>Substrate properties</b>	Rich in structure, rich in lignin	Poor in structure, Lignin poor
<b>Water content</b>	25-65%	45-90%
<b>Microorganisms</b>	facultative anaerobic, aerobic, bacteria, fungi, molds, yeasts, protozoa, rotifers, earthworms	fermentative, facultative anaerobic bacteria, strictly anaerobic archaea
<b>Temperature</b>	thermophilic (50-70 °C)	mesophilic (30-40 °C) thermophilic (50-55°C)
<b>pH-Value</b>	neutral to low alkaline	acidic to low alkaline
<b>Process duration</b>	8-19 Weeks	2-8 Weeks
<b>Degradation products</b>	Carbon dioxide, Heat	Methane, Carbon dioxide
<b>Technical input</b>	low to big danger of corrosion	big to very big
<b>Specific Land Use</b>	0,7-1 m <sup>2</sup> /Mg Input	0,2-0,3 m <sup>3</sup> /Mg Input 0,2-0,5 m <sup>2</sup> /Mg Input (aerob)



### 5.4.1 Fertiliser products from digestate

In contrast to compost the complete digestate from anaerobic digestion plants is usually liquid and contains considerable amounts of ammonium nitrogen ( $\text{NH}_4\text{-N}$ ). Because of this digestate is a quicker acting fertiliser which can be applied close to the plants' nitrogen demand. Additionally, organically bound nitrogen needs time to mineralise in order to become plant available. This part contributes to the soils' nitrogen reserve. On the other hand, ammonium is in a balance with ammonia ( $\text{NH}_3$ ), a gas that is released from the digestate at high temperatures and/or high pH-levels. Ammonia volatilisation leads to nitrogen losses into the air. Therefore special care has to be taken when applying digestate to the land. To minimise losses digestate is best applied during good growing conditions using a band applicator (trailing hose or trailing shoe) or a shallow injection system. In combination with a flow meter and a NIRS to determine the fertiliser value in real-time an optimal fertilisation is possible.

Digestate treatment has become increasingly relevant as an alternative to conventional land application, especially in regions where a high number of animal heads and many biogas plants exist, because both animal husbandry and anaerobic digestion produce fertilizer and thus influence the nutrient balance in the soil.

Digestate treatment is carried out to:

- Save application costs
- Facilitate transportation and nutrient export away from regions with a high nutrient concentration
- Produce marketable fertilizer
- Produce compost
- Reduce the amount of nutrients in the liquid phase
- Avoid the escape of gaseous pollutants into the atmosphere
- Decompose odor intense components
- Deactivate pathogens and weed seeds
- Improve transportability and reduce storage space through liquid removal

(Lokale Energie Agentur Oststeiermark, 2007; Weiland, 1997)

When it comes to digestate treatment, there are **physical**, **chemical** and **biological** processes, which, in many cases, depend on each other. Regardless of the final product the basic treatment processes usually start with the same first step: digestate is brought into a solid-liquid separator, producing a solid and a liquid phase. These phases are either treated further or applied directly to the field. Figure 18 shows this basic process step.

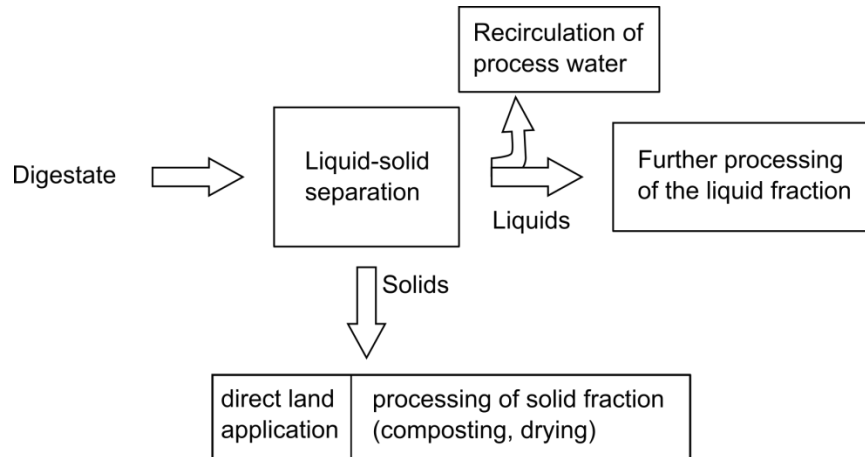

Figure 18: Basic processes of digestate upgrading (Fuchs & Drosig, 2010)

The following paragraphs describe the principle functioning of basic and further processing. Whether or not digestate treatment makes sense depends on many factors, especially the need for nutrient exports or the creation of a new business case, because each treatment step involves additional machinery, energy and efforts resulting in increased costs for the final products.

#### 5.4.1.1 Physical treatment methods

Physical treatment usually starts with separating **solid matter** from the liquid. This reduces the storage volume for the liquid phase, allows better fertilizer management and also facilitates further treatment of the solid matter. Further treatment of the solid matter usually includes drying or composting and sometimes pelletizing of the solid phase for the purpose of stabilization and upgrading the former digestate into a marketable product. This produces solid fertilizer, litter and, although very rarely, pellets to serve as fuel in stoves. For the most part, the practice of burning digestate pellets is still subject of discussion and research – especially because of the higher NO<sub>x</sub>-emissions in comparison with conventional burning materials. (Fuchs & Drosig, 2010)

The **liquid** phase's most popular application is still a land application for agricultural biogas plants. If the feedstock has a high dry matter content it is also recirculated within the plant to dilute the feedstock. In this case, nitrogen accumulation might be an issue and respective monitoring is needed.

For biogas plants in regions with a high nutrient concentration, it might be necessary to further treat the liquid phase because the maximum amount of nitrogen in the soil would otherwise be exceeded. In this case, the methods and targets are twofold:

- Mass reduction, mostly through vaporization or membrane separation techniques
- Extraction of nutrients or other components which allow the remaining liquid phase to be brought into surface waters

In most cases, these targets can only be achieved by lining up multiple processes. This means that the treatment is connected to relatively high efforts and costs.

Further physical treatment methods include ammonia-stripping, drying through evaporation and reverse-osmosis.

Examples of full-scale applications for nutrients recovery from digestate including a techno-economic analysis are given in Bolzonella et al (2018).



5.4.1.1.1 Screw press separators and decanter centrifuges

Depending on the digestate properties typical machines used for liquid-solid-separation are screw-press-separators or decanter centrifuges. Screw-press separators are used for fibrous digestate, as the fibres build a press cake that contributes to the result. Non-fibrous slurries, e.g. from anaerobic sludge stabilization or catering waste digestion, are separated using decanter centrifuges for separating liquids from solids. Often flocculants are needed to achieve an acceptable separation result.

Both the screw press separators and centrifuges represent “state of the art”-technology which means that they are relatively easy to handle and cost-efficient in both investment and maintenance.

The liquid phase makes up the majority of the mass, usually between 80 and 90 % of the total input. Further processing of the digestate without any previous separation of the solid and liquid phases is only rarely carried out. (Lokale Energie Agentur Oststeiermark, 2007)

It is not possible to separate or extract nutrients from the digestate with these applications, meaning that the nitrogen will remain in both phases, predominantly in the liquid phase. Phosphorus, however, is predominantly available in the solid phase.

Of these two machines, the screw press separator represents the most energy-efficient with a consumption of around 0.4-0.5 kWh/m<sup>3</sup> compared to that of the centrifuges 3-5 kWh/m<sup>3</sup>. Figure 19 shows the effect of mechanic separation (carried out with screw extractor separator) of digestate with the distribution of mass and contained components. The blue bars represent the liquid and the green bars the solid phase. (Fuchs & Drosch, 2010)

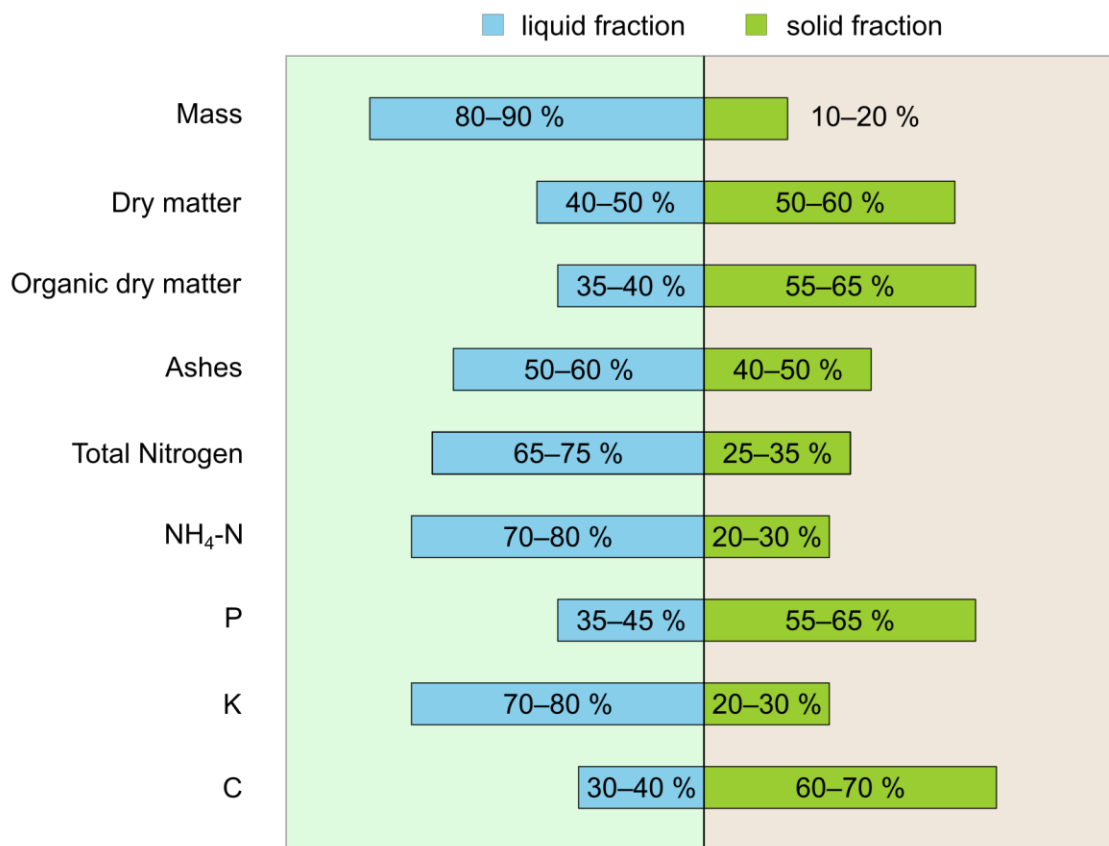

Figure 19: Nutrient distribution in digestate

As can be seen in Figure 19, the majority of the total mass and also the nitrogen content of the digestate, both total and organically bound, remains in the liquid phase after separation. This is especially important in regions where nutrient overload, nitrogen in particular, is an issue. Depending on the severity a subsequent further nitrogen removal – e.g. via stripping (section 5.4.1.1.5) – is theoretically possible and easier to achieve.

#### 5.4.1.1.2 Belt filters

Using a belt filter for solid-liquid separation of the digestate produces a solid phase with very high dry matter content compared to the screw press separator. It also consumes less energy than a centrifuge. A major downside is the high demand of flocculation products (chemical treatment) which are necessary for a satisfying separation process. It is about two to three times higher compared to the centrifuge and power consumption amounts to 1.5–2 kWh/m<sup>3</sup>.

#### 5.4.1.1.3 Drying through evaporation

Since thermal drying is very energy-intensive, this method is only used after a mechanical separation of the solid and liquid phases through one of the above-mentioned treatment options has been carried out. Normally the solid phase is dried further to make its transport more economic.

It is also possible to process the liquid phase using vacuum evaporation. Here the target is also volume reduction by evaporating the water and thus concentrating the nutrients in the concentrate. Often the concentrate is mixed with the separated solids before they are either dried further or spread on the land. The water vapour also still contains nutrients and can only be released into surface waters after yet further treatment.

In any of the two cases, a cheap heat source is needed, which is typically the recovered heat from the CHP-unit burning the biogas. Heat leads to increased ammonia evaporation and care has to be taken to recover ammonia in order to prevent venting it to the atmosphere.

The most common use for dried fertilizer is still agriculture, although attempts are being made to market the product to private gardeners. The reduced volume allows exporting nutrients to other regions.

#### 5.4.1.1.4 Filtration and reverse-osmosis

If a separation of fine, organic and inorganic digestate components from the liquid phase is desired, **micro- and ultrafiltration** represent an interesting treatment method, especially as a pre-treatment for the following reverse-osmosis. The size of removable particles ranges from 10 µm to 0.01 µm.

During the **reverse-osmosis**, the pre-treated liquid phase is pushed through a semi-permeable membrane to remove suspended solids, organic compounds, colourants, viruses and bacteria from the water. Around 95-99 % of all suspended solids and 99 % of the bacteria can be removed through this method.

#### 5.4.1.1.5 Ammonia-stripping

For the purpose of removing ammonia from the liquid phase or to extract it for fertiliser production, the liquid phase of the digestate can be stripped. This means that volatile compounds inside the liquid are pushed out via stripping gas. The volatile compounds enter the gaseous phase through an increase in temperature or a reduction in pressure and are then carried out of the system with the stripping gas. Usually, the stripping gas passes an acid washer to remove the ammonia from the gas before it is released to the atmosphere. Alternatively, the gas can be passed through gypsum (e.g. from flue gas desulphurization). In both cases, the final product is ammonium-sulphate-solution, a commercial fertilizer product. Depending on the stripping method CO<sub>2</sub> might also be released from digestate (One example is the ANA-Strip process by GNS). This CO<sub>2</sub> would also react with gypsum producing lime, which is also used on agriculture as a soil amendment.

#### 5.4.1.2 Chemical treatment methods

The digestate is treated chemically for the purpose of extracting nutrients, but also to prepare the digestate or slurry for liquid-solid-separation. For a complete removal of all nutrients, multiple processing steps are necessary. **Flocculation** and **precipitation of the nutrients** are the most common chemical treatments. This method is effective for phosphate but is not relevant for nitrogen removal. For this reason and for the high costs, the chemical treatment is not commonly used in agricultural biogas plants.

To reduce the nutrient quantity and extract them, iron- and aluminium-salts can be added to the digestate. This causes a **flocculation**, transferring the compounds into an insoluble state allowing the solid flocculants to be removed from the liquid via sedimentation, filtration or flotation. Although this technology represents a safe and reliable practice, it is only rarely used since a market for nutrient fertiliser has to be established and this method only works in line with previous treatments. Newer approaches also use a combination of lowering the pH-value by adding acid to raw manure or digestate and thus dissolve phosphorous into the liquid phase. After separating the solids, a caustic base (sodium hydroxide) will cause the precipitation of phosphorous salts that can then be separated from the liquid. (Lokale Energie Agentur Oststeiermark, 2007; Fuchs & Drosch, 2010; Wetter, 2018)

#### 5.4.1.3 Biological treatment – composting

Aerobic degradation or composting of the solid phase of the digestate after the first mechanical separation is a widely exerted method to produce a valuable and marketable end product. Since the digestate already underwent anaerobic digestion, the reduced content of carbon-based compounds considerably shortens the aerobic digestion process. This also means that the process temperature is lower compared to composting without preceding anaerobic digestion. Thus, it takes more time for the digestate to be sanitized. In particular, the *Regulation on the recovery of biowaste agricultural, forestry and horticultural use soils* (BioAbV) regulates the condition of the composting process in order to be considered also as sanitation of the biowaste. Composting is especially popular in dry digestion biogas plants since the digestate does not need to be separated into a liquid and solid phase, and the BioAbV regulates that the water content should be at least 40%. (Bundesministerium der Justiz und für Verbraucherschutz, 2017).

### 5.4.2 Comparison of specific costs for digestate treatment methods

Naturally, the most important criteria for planning and running a digestate treatment line are the investment and operating costs. All numbers of Table 4 compares net costs for six different method combinations. These represent a rough approximation since the exact costs depend on multiple factors like the type of the transporting machine, the distance from the biogas plant to the fields, the share of the liquid phase in the digestate, the nutrient content and more. (Fuchs & Drosch, 2010).

Table 4: Comparison of specific costs for digestate treatment methods. (Fuchs & Drosch, 2010)

	Direct digestate application	Screw press separation and application	Screw press separation and drying on a belt dryer	Centrifugal separation, ultrafiltration and reverse-osmosis	Centrifugal separation and evaporation	Centrifugal separation, stripping and flocculation
	[€/m <sup>3</sup> Digestate]					
Fixed costs	1.62	2.15	4.01	5.19	3.03	5.07
Energy and operation materials costs	0.29	0.30	3.74	2.77	7.03	3.42
Transportation and application costs	4.42	4.77	4.53	3.17	2.82	2.21
Gross costs	6.33	7.23	12.28	11.13	12.88	10.70
Nutrients (saved fertilizer costs)	-4.40	-4.40	-4.26	-4.40	-4.40	-4.38
Bonus for own heat usage *	-	-	-1.23	-	-2.15	-0.88
<b>Net costs</b>	<b>1.94</b>	<b>2.82</b>	<b>6.80</b>	<b>6.72</b>	<b>6.32</b>	<b>5.43</b>

Note\*: Bonus for own heat usage is depending on national legislation.

For the biogas plant operator, the most economical solution to treat digestate is the direct application onto the fields, followed closely by the solid-liquid separation using screw presses in combination with land application. Nutrients are mentioned as negative costs because the operator doesn't have to spend money on phosphorus-, nitrogen- and potassium-fertilizer. All processing steps lead to higher costs in comparison with direct application which is why digestate upgrading can only be economically attractive if there is a market for recovered and easily transportable nutrients or if the nutrient pressure on soil is very high. The condition for this scenario is a surplus of nutrients in the region where the biogas plant substrates are produced.

In future, a combination of treatment methods aiming at removing and concentrating nitrogen and phosphorous from digestate will become more and more relevant. The remaining water is rich in potassium

and can be applied to the land close to the biogas plant, while recovered nitrogen and phosphorous products are likely to be used in dedicated fertiliser products.

### 5.4.3 Best practice example: Agroenergie Hohenlohe GmbH

Originally Mr. Karles business was to fatten pigs. Due to low prices in this sector, he began to investigate additional sources of income for his farm. Biogas seemed to be a good option since it allows to generate income from treating manures. The plan was to complement the manure with other feedstock like sugar beet leaves and organic residues from the farm.

At that time – the turn of the millennium – only a small number of biogas plants existed and one had to travel far to visit a biogas plant and talk to operators about their experiences. This way Mr. Karle developed the idea about “his” biogas plant.

In 2001 Thomas Karle started operating his first biogas plant. The biogas plant was constructed with quite simple technology and had a digester volume of 600 m<sup>3</sup> and a co-generation unit with the power of 55 kW<sub>el</sub>, which was below average (190 kW<sub>el</sub>) at that time. Over time the biogas plant has been modified and optimised continuously.

Mr. Karle took the first step in 2003 when he increased the size of his biogas plant and installed a bigger CHP-unit with approx. 300 kW of electrical power. Operation of the new plant started in 2004. To produce the necessary amount of gas Mr. Karle increased the amount of digested energy crops and also added leftovers from fruit and vegetable processing.

Again, in 2007 the biogas plant was upgraded by installing a micro gas-turbine in cooperation with Greenenvironment GmbH and by constructing a green-house type system for drying the digestate. Greenhouse and micro gas-turbine had the synergy effect that exhaust gas from the gas turbine served as hot air for the drying process. After drying the digestate is pelletised and sold as fertiliser (see Figure 20 and Figure 21).



Figure 20: Pellets from Digestate (picture credits: IBBK Fachgruppe Bigoas GmbH)



Figure 21: Figure: Packaged Pellets for private Gardeners (picture credits: IBBK Fachgruppe Biogas GmbH)

To maximise the heat use from the CHP Mr. Karle has built a district heating grid in 2009 to supply the village of Füßbach with renewable heat. When the district heating started operation in winter 2009/2010,

This project has received funding from the European Union’s Horizon 2020 research and innovation programme under grant agreement No 688338



Fußbach was awarded to be the first “Bioenergy village” in the district. Another part of the heat is used for grain drying by an external company.

In 2012 the micro gas-turbines were taken out of operation because of technical issues with the gas cleaning. Instead a second CHP-unit was installed.

Since 2013 the CHPs are operated flexibly, which means that they produce electricity at times when electricity is expensive and don't run during the night, when the prices are low.

The next step of expanding the bioenergy village together with the biogas plant was the foundation of “eFüßle”, a car-sharing initiative for the village. At the moment the electricity for this initiative is taken from the grid into which the biogas plant also feeds the produced power. In future, after the period of fixed feed-in tariffs, electricity for charging the cars might directly come from the biogas plant.

Mr. Karle often cooperates with universities and research organisations. He collaborated with the “Fraunhofer Institut” in a project that aimed to find new and feasible ways for farms to produce a diverse range of fertilisers from the digestate. Currently, in 2019, a pilot plant for recovering nitrogen and phosphorous from digestate is taken to the next step by implementing a full-scale demonstration plant.



Figure 22: Biogas Plant Karle / Agro Energie Hohenlohe GmbH & Co. KG; blue containers in from: pilot plant for nutrient recovery (picture credit: IBBK Fachgruppe Biogas GmbH)

After a careful solids separation, the liquid phase is processed further. Nitrogen is recovered by firstly stripping it from the liquid and then washing it out of the stripped air in an acid washer producing ammonium sulphate solution. Phosphate is recovered by precipitating phosphorous salts. With those recovered nutrient streams it will be possible to produce tailor-made fertilisers for special demands, assumes Mr. Karle. What remains is a liquid with very low nutrient contents that is suitable for irrigation. More Information is available from the NoAW Factsheets (NoAW 2020 Factsheets, 2019).



#### 5.4.4 Best practice example: High nutrient dense ABC-BioPhosphate recovery from food grade animal bones

Europe's access to phosphate/phosphorus (critical raw material) is under threat, over >88% reliant on imports while contains dangerously high levels of Cadmium/Uraniun toxic metals.

TERRA BioPhosphate has been objective driven developed to fully meet Circular-Economy Fertilising Products Regulation and its new markets.

Terra developed (under multi-actor EU-application and market-driven RTD programmes 2002-2019) a market-creating, breakthrough and high-potential original innovation with the potential to create entirely new markets as of new 2022 EU Regulations to recover pure and concentrated phosphorus (BioPhosphate) from unexploited biomass food-grade cattle animal bone.

The company's proprietary "3R" zero-emission-pyrolysis-technology treats the bones at 850°C high carbon refinery temperature in the absence of oxygen. The result is the (apatite-based) BioPhosphate with 30%-36%  $P_2O_5$  content, having same concentration as mineral phosphate (also apatite-based) and considerably higher than other organic sources, usually far below <5%-  $P_2O_5$ .

The ABC-BioPhosphate is a natural and organic product with macrospores structure and economically high concentrated recovered Phosphorus content, that is made of food-grade animal bones. According to the Eurostat databases more than 45 million tonnes of animals (bovine, poultries and pigs) slaughtered in the EU 28 countries (Eurostat, 2015).

The ABC-BioPhosphate commercial products formulated to BIO-NPK-C in any composition as of user/market demands for both organic and low input farming application cases.

The ABC-BioPhosphate contains a high amount of Phosphorus expressed in  $P_2O_5$  (over >30%) and Calcium (37%) that are processed to be available for plants, which allows efficient, environmentally safe and naturally renewable phosphorus supply. Besides the highly available recovered phosphorus/calcium content, the ABC-BioPhosphate also contains other important recovered trace elements, and other nutrients, such as K and Mg.

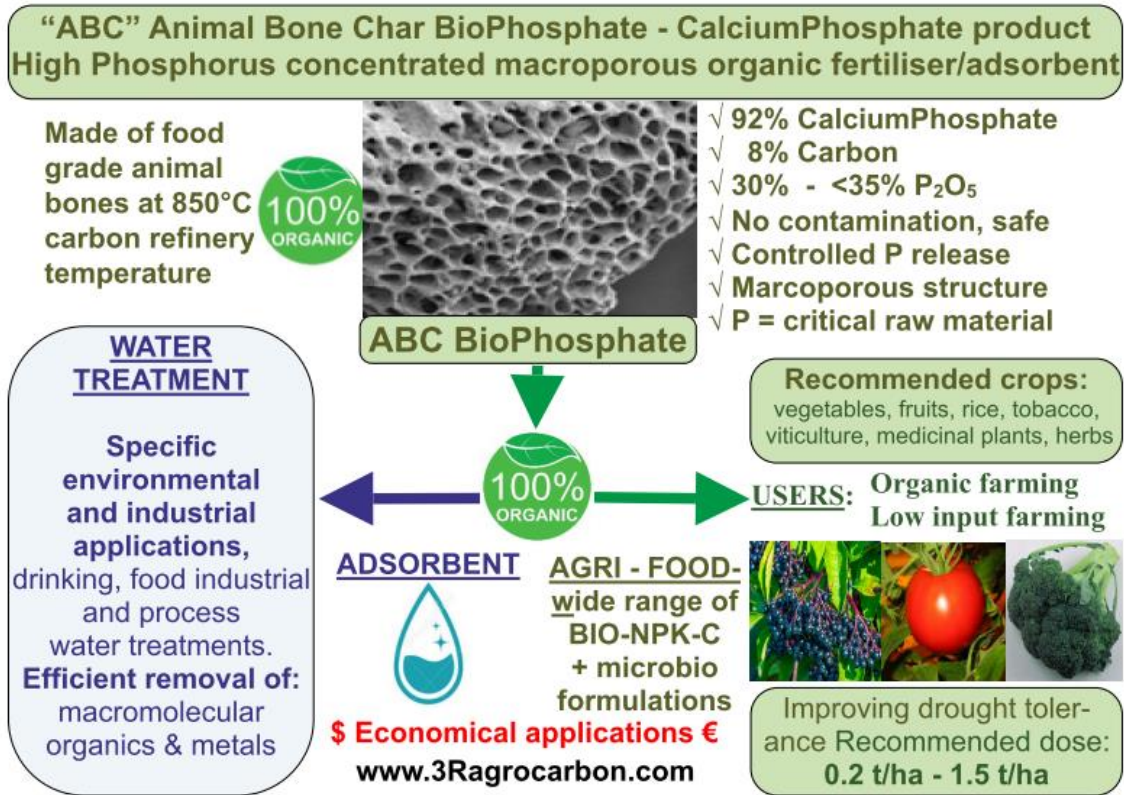

Figure 23: BioPhosphate technology (Figure credit: Terra Humana Ltd.)

The product is a fully safe and economical innovative fertilizer with primarily application in the horticultural organic/low input farming cultivations with combined beneficial and multiple effects. The market competitive ABC-BioPhosphate product is proven field demonstrated to validate ABC-BioPhosphate agronomical effects. Several open field and greenhouse cultivation tests have been performed in IT, IL, HU, DE, NL, SI and DK under different temperate climatic and soil conditions. Both the 3R zero emission pyrolysis and nutrient recovery process and the ABC-BioPhosphate products in open ecological soil environments are EU Authority permitted. (MS permit number: 6300/13393-2/2019 for lawful marketing in the EU 27 according to the EU 2019/515 implemented beyond 19 April, 2020.)

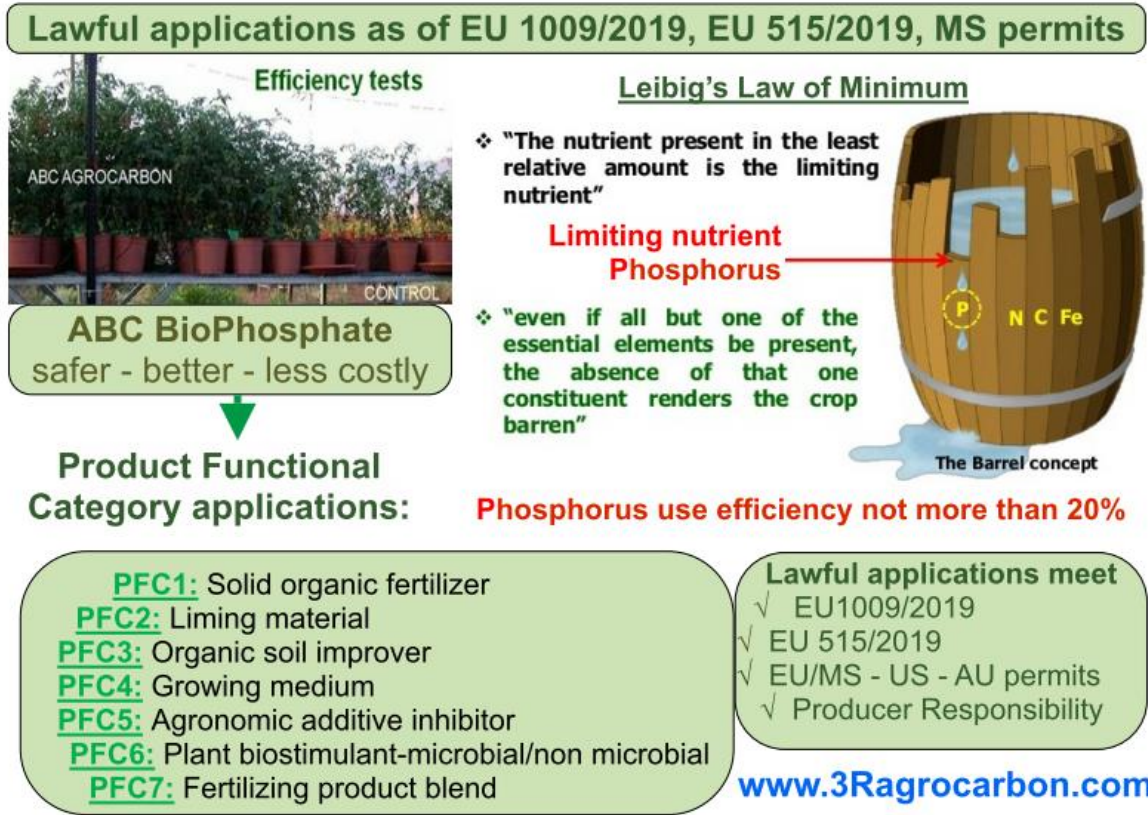

Figure 24: BioPhosphate products (Figure credit: Terra Humana Ltd.)

BioPhosphate technology and product information:

[nutriman.net/farmer-platform/product/id\\_192](http://nutriman.net/farmer-platform/product/id_192)

[nutriman.net/farmer-platform/technology/id\\_193](http://nutriman.net/farmer-platform/technology/id_193)

[www.3Ragrocarbon.com](http://www.3Ragrocarbon.com)

## 5.5 Best practice examples of waste valorisation routes

Within the NoAW project, an expert assessment on strengths, weaknesses, opportunities and threats (SWOT) of different waste valorisation routes was conducted. The so-called “SWOT analysis” aimed at identifying the strengths and weaknesses of the valorisation routes (internal to the valorisation routes) and to relate them with the opportunities and threats of the macro environment (external to the valorisation routes), such as economic or legal conditions.

To conduct the SWOT analysis, almost 60 interviews with experts in Europe and China were analysed. The target group of the interviews comprised a wide range of stakeholders dealing with agricultural wastes such as farmers, converters, R&D institutions, governmental organisations, NGOs and universities. In these interviews, the experts were asked for their most preferred valorisation routes and their assessment on these routes. These statements were coded to the 4 categories of SWOT: strengths, weaknesses, opportunities and threats.

This best practice guideline now focusses on the success factors and barriers of the SWOT results of the most preferred and most mentioned valorisation routines, as the experts overall mentioned more than 30 different valorisation routes.

### Grinding and mulching

Mainly stakeholders of the wine sector refer to this already established waste valorisation route. The majority of experts assess grinding and mulching as a low-cost valorisation route as it is labour extensive and time extensive. Additionally, it is easy to implement and has a positive environmental impact such as on the soil balance by improving the organic matter in soils. It meets today’s and future legal obligations. A success factor for grinding and mulching is identified in a legal obligation or tax incentives which in future could favour the use of wastes for grinding and mulching. Furthermore, it is successful if the cost- and time-effectiveness are major decision criteria for the valorisation route. A failure factor refers to the costly machinery for grinding and mulching and the lack of qualified staff.

### Composting

The experts assess composting as a cost-effective, environmentally- and particularly soil-friendly valorisation route. Major success factors from the experts’ point of view is the necessity to identify suitable markets for the valorised product and the handling of legal obligations or tax incentives. The combination of composting with biofuel production seems promising. Barriers are mainly identified for those schemes where composting is organized on a supra-organisational level. Schemes which need regrouping, sorting, treating and selling seem to hold several uncertainties and challenges. Firstly, investments are needed for cost-efficient solutions to collect and sort waste. Secondly, bureaucratic barriers should be reduced. Hence, at this moment, composting is a suitable valorisation route for straw-containing manures and plant residues on the level of the individual organisation. Composting at a bigger scale is less evident and needs solutions in terms of logistics, investments and marketing.

### Biomaterials

In general, the experts assess biomaterials as a future-oriented and commercially interesting technology. Furthermore, its scheme is advantageous as it can be combined with other valorisation routes such as biofertilizer and bioenergy. The experts emphasize an urgent necessity for a more cost-effective production of biomaterials, e.g. by combining its production with other valorisation routes. A further success factor is the need to invest in Research and Development as well as market research to identify possible markets. Barriers for a success of biomaterial valorisation routes are subsidies which favour biogas production and that not all wastes are suitable to produce biomaterials.



### Biogas and bioenergy (biomass)

Many experts comment on the valorisation routes biogas and bioenergy, wherefore only the most often arguments will be presented here. Biogas and bioenergy are assessed as a future-oriented promising technology. It is advantageous as it is an environmentally friendly technique. Many different success factors were mentioned, such as the profitability and cost-effectiveness of this valorisation route and the present degree of maturity of this valorisation route e.g. regarding the method itself and the logistic infrastructure. The possibility to combine this valorisation route with agricultural activities and other valorisation routes (biorefinery, composting, bio fertilisers) appears to be even more attractive. Furthermore, a crucial success factor is the governmental support as bioenergy is subsidized and biogas and bioenergy are a crucial part of the recent transformation of the energy sector. The experts identify barriers mainly in the availability of feedstock in sufficient quantity and quality and the along coming logistic questions, such as the collection of wastes. They also refer to certain challenges that can cause high production costs, e.g. depreciation, transportation, maintenance, labour and collection.

### Bio fertilisation

Many experts comment on the valorisation routes bio fertilisation, which is why only the most often arguments will be presented here. Many experts evaluate bio fertilization as a future-oriented and environmentally and soil friendly techniques contributing to a circular economy approach. Some experts state that it is a low-cost technique, e.g. because other ways to dispose of slurry and manure would be more expensive. It is also advantageous as it can also be combined with other waste valorisation routes. Relevant success factors are primarily the cost-effective of bio fertilisation, because the demand is still low and costs for collecting, transportation etc. of the wastes are high. A clear promoting factor are legal obligations or economic incentives through taxes to further push the bio fertilisation scheme. However, the legal framework for bio fertilisation is not yet clear. Missing logistical infrastructure due to e.g. missing storing or collection possibilities are also barriers for market success. Threats are also existing through the low costs of fossil-based fertilizer options.

### Synthesis of SWOT

Biogas, biomaterials and biofertilizers are considered as the most promising valorisation routes and confirm the pertinence of the cascading principle.

The **topic of logistics and appropriate scale** of the sites is for sure a crucial transversal challenge. Solutions for identifying, sorting, stocking and storing, transporting as well feedstock as of products is a crucial one. The necessity of, at least in part of the domains, industrial scale of the processing plants becomes evident. Particularly collecting and transporting heterogeneous low-value feedstock over long distances and from a large number of sites has evident limits. Re-distributing organic matter back to the agricultural land where they origin constitutes a further challenge. The ecological footprint is one of the key requirements to be fulfilled by future solutions, the transport issue has to be considered critically. Consequently, the research and development efforts have to take into account that not only big industrial sites are to be conceived, but as well medium or smaller solutions for local scopes.

The **equilibrium of organic matter in soils** is as well raised transversally by the experts. Soil fertility depends in a crucial manner on the content of organic matter. Modern agriculture has brought about an important reduction of organic matter, rendering soils vulnerably to erosion and incapable of maintaining nutrients and water. Future-oriented solutions for valorisation routes must consider this and organic matter (from manure and straw) must be fed back into soils. This is particularly important for organic agriculture which, following consumer demand, occupies rising surfaces all over Europe.

Another transversal issue is the question of **investments**: even in well-established valorisation routes, the economic equilibrium is often fragile and depends on the competitiveness with fossil-based material flows. It is difficult to get private funds for bigger and long-term investments under these conditions.

**Research and development** are the next transversal issue. All valorisation routes evoked here, even the well-established ones, need still more and new research and development input, on technical questions as well as on logistics and socioeconomics.

## 5.6 System approach for waste and loss analysis

There is an increasing demand for a more competitive production and on a global food market cost reduction is a basic requirement for food SMEs. Wastes, losses and related unnecessary costs can be identified by a system approach for waste and loss analysis. A new procedure was developed by Campden BRI Hungary for systematic identification of the valorisation opportunities of agro-waste to ensure the selection of the most feasible eco-efficient valorisation routes. The structured approach includes a step-by-step analysis of types, amount, sources, causes of losses and waste; the definition and characterisation of the targeted intermediate or end product for each valorisable material for each process step; the identification of methods, solutions, techniques for valorisation of waste, by-products into exploitable materials, products; followed by an exploration of the different alternatives; evaluation of strategies and techniques for valorisation of waste and by-products, and selection of the most efficient valorisation routes. Existing methods put less emphasis on chain approach therefore this new method provides a new framework. It helps to understand the potential of prevention, reduction and valorisation of agricultural wastes along the whole chain and integrates different assessments such as compliance with human safety and legal requirements, evaluation of environmental and social impact.

### Short description of the concept

The approach is based on mapping the process of production of the agricultural material along the whole value chain and analysis of the types of waste and losses, their causes, sources and valorisable material content step by step. Mapping means splitting the whole process into consecutive steps and preparing a flow chart. At the valorisation phase for the selected valorisation routes, the flow-chart has to be extended with the steps of the valorisation processes.

For each type of waste and losses and each cause of waste and losses the methods for its control (Reduce-Reuse-Recycle, i.e. prevention, elimination, reduction to an acceptable level) or/and valorisation will be defined systematically, the feasibility of the application for each control method and valorisation method will be assessed and the priorities will be established. An inventory of valorisable materials will be prepared during the step-by-step analysis.

Based on the priority analysis the hotspots for control of losses and valorisation of waste will be identified.

The flow chart shows the main steps from step1 to step 23, and it contains decision points.

The main approach is the following:

1. **It has to be ensured that only that type and amount of waste is generated, which is unavoidable**, e.g. to maintain the level of waste at the technical minimum (REDUCE principle). For this task, the amount of the generated waste and losses have to be measured and performance criteria shall be established for controlling the waste generation and to indicate when the actual operation is acceptable. (Steps 4, 6-9, see the flow chart).
2. For the **waste, which can't be avoided, the hotspots have to be identified**, considering the whole process of waste valorisation from collection through segregation, stabilisation, logistics till conversion. For **hot-spots strategies and techniques for valorisation of the waste and the by-products**

This project has received funding from the European Union's Horizon 2020 research and innovation programme under grant agreement No 688338



---

**have to be selected** (REUSE and RECYCLE principles) and developed, and their feasibility be verified with focus on the hot-spots. (Steps 5, 10-18, see the flow chart)

3. For the feasible strategies, technologies, the **compliance to food/feed safety and legal requirements has to be checked**. (Step 19, see the flow chart)

4. For those which are in compliance with the food safety and legal requirements, the **acceptability from the aspects of environmental** (step 20, see the flow chart) and **social impact** (step 21, see the flow chart) has to be evaluated.

5. Those **strategies, which are acceptable from the aspects of environmental and social impact, will be implemented**. (step 22, see the flow chart)

6. The whole analysis **has to be re-evaluated periodically at least every 3 years**, or in case of any significant change in the process. (step 23, see the flow chart)

## Flow Chart

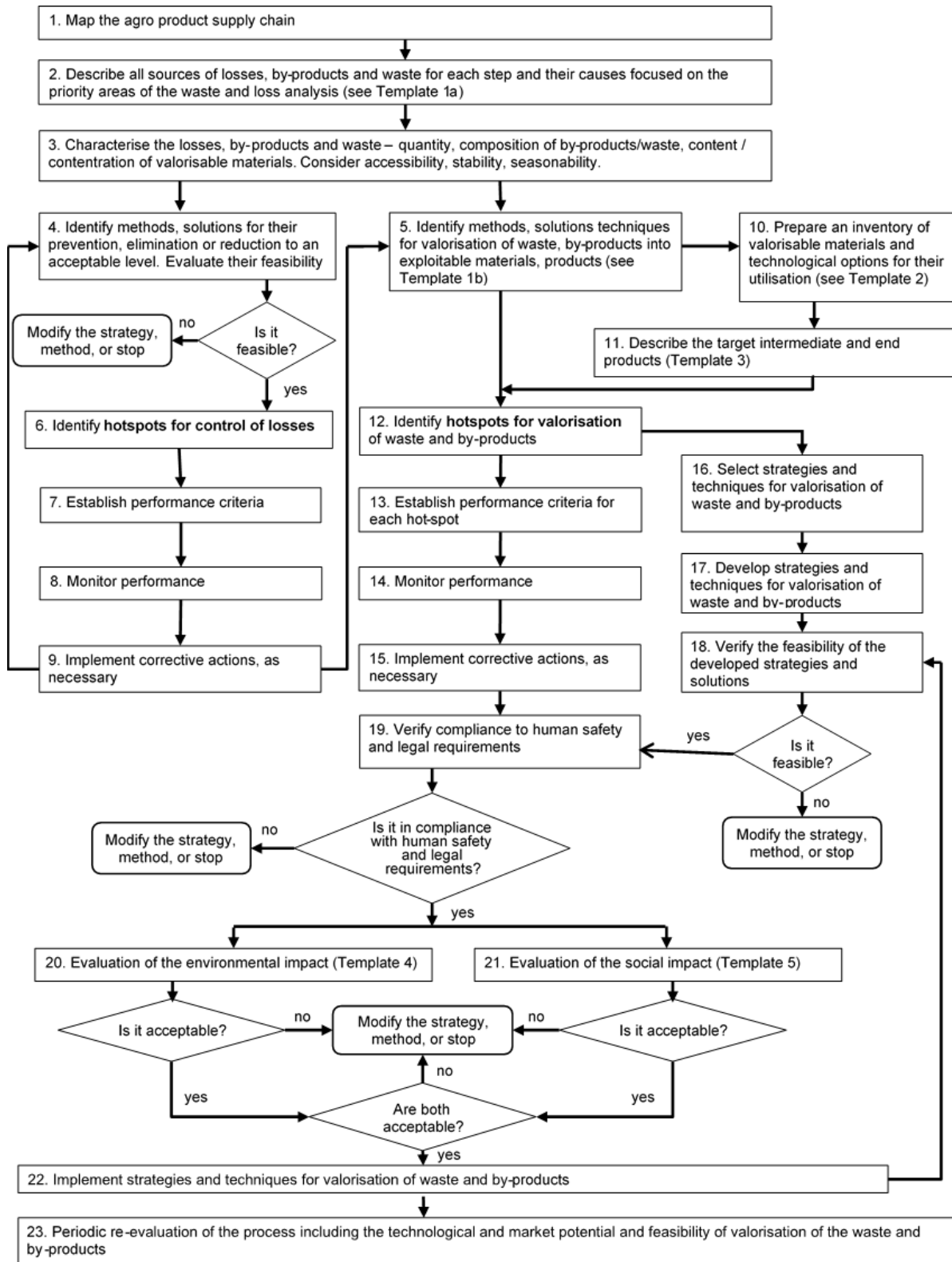

This project has received funding from the European Union’s Horizon 2020 research and innovation programme under grant agreement No 688338

A short explanation per step in the flow chart.

1. Map the agro product supply chain.
  - ✓ Define the agro product chain, which is analysed.
  - ✓ Define the starting steps and the final step of the agro-product chain.
  - ✓ Define the area of application. Specify the geographical area and/or a specific case within that, as appropriate.
2. For each process step of the production of the agricultural product list each type of waste + cause and targeted use (Template 1.a) Waste type/name: an accurate description of the type of the waste, e.g. straw, manure, head of sugar beet, corn husk, etc. Type of valorisable material: protein, bioactive material, biogas, PHA, digestate etc.
3. Describe the total quantity of waste, the concentration of the valorisable material and calculate the quantity of these valorisable materials
4. Define methods, techniques, technologies (measures), which can be used as prevention measures: to reduce Quantity (column J) by elimination or reduction of waste and by-products to an acceptable level OR measures to improve the Quality/Yield of the waste for further processing as applicable at the generating process.  
Calculate scores for defining the priorities from the previous aspects of preventive measures.

Use the following priority matrix:

Feasibility Significance	1.Difficult	2.Low	3.Medium	4.Considerable	5.Easy
1.Negligible	1	2	3	4	5
2.Medium	1	4	6	8	10
3.Considerable	3	6	9	12	15
4.High	4	8	12	16	20

*Notes: the categories of priority:*

*1 - 4: Action is not required*

*5 - 8: Short term action is not urgent, consider actions, changes on longer term*

*9 - 11: Action necessary*

*12 - 20: First priority for action*

6. Based on the top priority define hotspots, which are the main points on which preventive actions for reduction of waste should be focused.
7. Define measurable performance criteria, which indicate whether the waste reduction activities are carried out properly.
8. Establish a system for monitoring the performance of the preventive action. Define the method of monitoring, minimum frequency of checking (a continuous monitoring may be applicable), the responsibilities for monitoring and the file, where records are made.

9. Define and implement corrective action for the case, when monitoring indicates that the performance is poorer than the level defined by the performance criteria. Define the task to be carried out, the responsibility of corrective actions and name of the file, in which records are made.
5. Define the targeted intermediate or end product for each valorisable material for each process step (Template 1.b.)  
For each process step and targeted product and waste type define the measures (method, technology), which can be used to prepare the intermediate and end product.
10. Prepare an inventory for valorisable material (Template 2)
11. Characterise/describe the target intermediate/end product obtained from valorisation of agrowaste (Template 3).  
Prepare a description for each targeted end product and intermediate product.
16. Select strategies and techniques for valorisation of waste and by-products
17. Develop strategies and techniques.
18. Verify their feasibility.
19. Define the priority for valorisation of waste (Template 1.b).  
Use the same priority matrix as earlier:

Feasibility Significance	1.Difficult	2.Low	3.Medium	4.Considerable	5.Easy
1.Negligible	1	2	3	4	5
2.Medium	1	4	6	8	10
3.Considerable	3	6	9	12	15
4.High	4	8	12	16	20

*Notes: the categories of priority:*

*1 - 4: Action is not required*

*5 - 8: Short term action is not urgent, consider actions, changes on longer term*

*9 - 11: Action necessary*

*12 - 20: First priority for action*

*The top priority have /has methods, where the higher scores were received.*

12. Select hot-spots, priority action points for waste valorisation. These valorisation hotspots are the key points, which basically influence the success of the valorisation and where the proper operation of valorisation efforts has the largest impact.
13. Define performance criteria for the key steps of the valorisation procedure, when the process operates appropriately.
14. Establish a system for monitoring the performance of the valorisation step. Describe the method of checking, the frequency, the responsible person(s) and the files, where records are made.
15. Define corrective actions for the case, where the performance is not in line with the set performance criteria. Define the tasks to be carried out, the responsibility for the corrective action and the files, where records are made.
19. Evaluate compliance with human safety and legal requirements.

This project has received funding from the European Union's Horizon 2020 research and innovation programme under grant agreement No 688338

- 
- 20-21. If the product/process in compliance with the human safety and legal requirements, evaluate environmental impact (Template 4) and social impact (Template 5).  
The aspects of the evaluation of the environmental and societal impact for templates 4 and 5 will be provided by the NoAW project at a later stage.
22. Implement the strategies and techniques.
23. Review the whole process at any changes or at least in every 3 years.

## 1. Template for waste and loss analysis (a)

Process step in the chain	Waste type / source valorisable material, cause and targeted use	Quantity				Geographical area (region)	Seasonability (e.g. all year, or give month to month period for availability)	Current use of the waste
		Total waste amount (tons per year)	Component	Concentration of valorisable material (% , ppm etc. on DRY basis)	Total quantity of valorisable material (dry tons per year)			

Notes:

- Column B Waste type/name: accurate description of the type of the waste, e.g. straw, manure, head of sugar beet, corn husk, etc.
- Column C Type of valorisable material: protein, bioactive material, biogas, digestate, PHA, etc.
- Column D Please provide details for ALL valorisable components (1 line per component)
- Column G Seasonability: indicate NO or specify the period of availability, as appropriate
- Column H Current use of the waste: provide: intermediate and/or end product

## 1. Template for waste and loss analysis (a) - cont'd

Preventive measure aspects		Priority for preventive measures			Hot spot for PRevention	Performance criteria for PRevention	Monitoring (Method, Frequency, Responsibility, Record)	Corrective Actions (Tasks, Responsibility, Record)
Measures to prevent, eliminate, reduce the QUANTITY of waste (method, technique, technology)	Measures to improve the QUALITY/YIELD of waste (method, technique, technology)	Significance S	Feasibility F	Priority S x F = P				

5. Priority matrix for preventive measures and for valorisation methods:

**S** Significance (1-4): 1. Negligible; 2. Medium; 3. Considerable; 4. High

**F** Feasibility (1-5): 1. Difficult; 2. Low; 3. Medium; 4. Considerable  
5. Easy (strong, economic, worth to deal with)

**P** Priority:

1 - 4: Action is not required  
5 - 8: Short term action is not urgent  
9 - 11: Action necessary  
12 - 20: First priority for action



## 1. Template for waste and loss analysis (b)

Process step in the chain	Potential use of the waste			Priority for valorisation of the waste			Hot spot for valorisation	Performance criteria for <u>the hot-spot</u>	Monitoring of the performance at the hot-spot (Method, Frequency, Responsibility, Record)	Corrective Actions (Tasks, Responsibility, Deadline, Record)
	Targeted intermediate or end product	Net quantity of valorisable material (dry tons per year)	Measures for valorisation of waste (methods, technologies)	S	F	P				

## Template 2: Inventory

Name of the valorisable material	Process generating the waste	Type of waste	Geographical area (region)	Quantity of the valorisable material (dry)	Current use of valorisable material	Amount of currently used valorisable material	Potential use of waste	Targeted intermediate and end product	Technology for conversion	Priority* (1-20)

**P** Priority:  
 1 - 4: Action is not required  
 5 - 8: Short term action is not urgent  
 9 - 11: Action necessary  
 12 - 20: First priority for action

**Template 3.1: Description of intermediate/end products obtained from valorisation of agro-waste**

<b>Name of the product:</b>	
<b>End product:</b>	Y/N
<b>Intermediate product:</b> <i>If yes, specify further processing needed</i>	Y/N
<b>Use of the product:</b>	
<b>Physical properties:</b>	
<b>Chemical properties:</b>	
<b>Biological/microbiological properties:</b>	
<b>Human safety of products:</b>	
<b>Use for:</b>	
<b>Use patterns:</b>	
<b>Target Group / Target Sector:</b>	
<b>Reference price (bulk product):</b>	
<b>Main competitor of the product:</b>	

**Template 4: Evaluation of environmental impact**

(Note: The current version is only a demonstration of the approach. This should be replaced by the evaluation methods developed by the NoAW project as the results are available)

Method, technology for valorisation of agro waste	Impact on soil	Impact on water	Impact on air/climate	Impact on energy	Total impact

**Template 5: Evaluation of social impact**

(Note: The current version is only a demonstration of the approach. This should be replaced by the evaluation methods developed by the NoAW project as the results are available)

Method, technology for valorisation of agro-waste	Impact on human health and safety	Impact on employment	Fair trading practices

## 6 Business models for agro-waste valorisation for practical implementation

### 6.1 Main triggers of eco-innovations

Participant researchers in NoAW project by the leading of SOFIES and DLO-FBR have collected and listed existing international business concepts designed for an efficient use of agro-resources. More than 60 successful initiatives have been analysed. Success and failure factors, as well as key triggers of initiatives, were analysed and concluded in case of clustered and non-clustered agricultural waste utilization initiatives at different levels. After collecting information on case studies, triggers were analysed and summarized in this chapter. Entrepreneurs with eco-innovative ideas may be looking for these triggers in different areas to support implementation and develop relevant business models.

From analysing case studies, it can be concluded that mainly technological, environmental reasons, and financial, market and legal aspects trigger industries to develop industrial ecology solutions. Market need as a trigger of an initiative was found 7 times, technical development, valorisation of by-products, recycling wastes, avoiding or reducing pollution, environmental awareness and need for sustainable development could be observed in 5 cases each and the other aspects appeared less than 5 cases.

Key triggers and objectives of the analysed initiatives are listed according to occurrences:

1. Market need
2. Technical development
3. Valorisation of by-products, recycling wastes
4. Avoiding or reducing pollution
5. Environmental awareness and the need for sustainable development
6. Legislation and incentives
7. Need to cooperate to increase effectiveness
8. Additional income generation
9. To be energetically independent
10. Corporate Social Responsibility (CSR), Green marketing

**The market need** for use of agro resources can be for example the increasing demand for bio-sourced aromatic or the demand to replace a significant share of conventional fossil-based plastics with 100% bio-based and biodegradable plastics. A trigger can be the growing need for proteins based agricultural by-products to feed animals, or for example producing cellulosic ethanol from biomass as an alternative to petroleum from agricultural residues. When a company's customers in an industry are constantly looking for new solutions to reduce their CO<sub>2</sub> footprint, then modern bio-based materials may also fulfil a market need. Promoting the development of a bioeconomy model based on the efficient use of renewable resources and on the regeneration of local areas may be also an important aspect.

**Technical development** is an important trigger when industrial technology goes forward, and companies intend to keep their competitiveness. An objective can be increasing resource efficiency and better process control with an environmentally friendly alternative to fossil-based heater. Technological development is also a trigger when the aim is to bring a patented technology from a pre-commercial level to a commercial level, including demonstration of the whole value chain. A discovery may be used for others (for instance medical) applications. District heating can also be developed by using agro-waste or biogas from agro-waste.

**Valorisation of by-products, recycling wastes** can trigger eco-initiatives, because agricultural by-products are valuable resources of raw materials. Valorisation of corn husk and rice husk at the same

time in a region may lead actors to cooperate. Farming cooperation, a vast agricultural area, huge biobased feedstock, vertical integration, high willingness to collaborate to innovate may also lead to eco-initiatives, even in the area of cross-sectoral and non-food applications. The regional manure surplus, the local availability of emitted CO<sub>2</sub> and heat financial incentives for bio-energy can subserve the valorisation of residual biomass and heat through mutual exchange between different companies. Recycling vegetable remnants from the food industry can be used for eco-friendly colours in the textile industry. Valorizing manure on farms in energy production can lead to being self-sufficient and energy independent.

**Avoiding pollution or reducing pollution** is a strong trigger for companies because of the environmental and health effects and consequences of pollution, and environmental challenges. The aim can be to produce biodegradable product alternative or producing renewable energy on the territory. Industrial by-products and sewage sludge can be valorized into gas for vehicles which fuel is more effective than classic fuels in terms of air and noise pollution. Reducing the carbon footprint of a product also aims to reduce pollution. Agricultural residues when burned or buried lead to greater pollution, but recycling by-products of agricultural residues and waste reduces pollution.

**Environmental awareness and the need for sustainable development** is a strong trigger for eco-initiatives. Some committed and environmentally conscious majors get inspired after a visit in Sweden and their aim is to achieve ambitious climate goals. Some companies aspired to further develop their business, but in a more eco-sustainable way than stand-alone. Recognizing the impact of rapid climate change on the survival of the human race and to uphold the philosophy that we must all do our part to protect our only planet, a textile company (Singtex) has invested hundreds of millions of dollars over recent years to establish a pioneering R&D centre and precision environmentally dyeing centre. Their objective was to increase added value and branding via the development of eco-friendly functional textiles, via a partial substitution of fossil-based components for increased textile functions. Another company's customers in the footwear and consumer electronics industries are constantly looking for new solutions to reduce their CO<sub>2</sub> footprint, and bio-based thermoplastics polyurethane is one such solution. A project aims to improve eco-friendly colours in the competitive textile industrial chain made from recycled vegetable remnants because tons of fruit and vegetable peelings with potentially fantastic dyeing properties are sorted and then thrown away to make bioethanol.

**Legislation and incentives** are a great help for implementing innovative green technologies and circular economy approach. Incentives, favourable conditions for renewable energy production leads to additional income generation for farms through renewable energy production. Energy costs and waste disposal costs can be reduced by biogas production from waste and burning it for energy production to cover electricity demand and heat demand (e.g. in case of slaughterhouses and many other industries). A law obliges winemakers to deliver their waste for distillation and valorisation of grape marc for distillation as a response to legal obligation.

**Need to cooperate to increase effectiveness:** Clustering companies in the direct environment of other companies they could benefit from in terms of waste management, natural resources and logistics. In several cases, there is a need to reach a critical mass for this bioeconomy "emerging" sector and a need to organize the value chains and de-risk investments. For example, objectives can be to develop sustainable and competitive biobased industries in Europe, based on advanced biorefineries that source their biomass sustainably by demonstrating new technologies using biomasses and new consumer products from biomass; developing new business models integrating economic actors along the value chains; and setting-up flagship biorefinery plants deploying technologies & business models.

**Additional income generation** for a farm through renewable energy production, nutrient recovery and export to other regions/sectors and favourable conditions for renewable energy production also enhances the opportunities for eco-innovations and implementing developments.

---

Willingness **to be energetically independent** also can be motivating trigger for farmers. For example, valorizing the manure produced on a farm, be self-sufficient and supply other households.

**Corporate Social Responsibility (CSR), green marketing**, branding and greener products can also trigger eco-initiatives and eco-developments. Strong sustainability vision at a company with sustainability strategy, calculating and reducing the carbon footprint of a product or a company may improve company judgment by consumers and customers.

The list of the investigated initiatives and contacts are available at the NoAW coordinators.

## 6.2 Success and failure factors of existing eco-innovative case studies

In this chapter key learnings from eco-innovative case studies are summarized that turn agricultural waste into ecological and economic assets. Researchers of SOFIES and DLO-FBR have collected and listed existing international business concepts designed for an efficient use of agro-resources by analysing more than 60 successful eco-initiatives (as mentioned above). Success and failure factors of initiatives were analysed and concluded in the case of clustered and non-clustered agricultural waste utilization initiatives at different levels. Results are summarized in the followings. (source: NoAW D5.1)

### Transversal learnings from eco-initiatives

- Every business model is context-based;
- Operational and costs optimization via shared infrastructures, utilities and expertise (reaching a cost-competitive production) is a must to accelerate the roll-out of the bio-based economy;
- Industrial symbiosis (e.g. for heat and CO<sub>2</sub>) requires large volumes to get a return on investment. Industrial symbiosis requires a series of actors with different responsibilities to work (developer of networks, traders);
- Setting-up a large facility/cluster can only happen when local governments, citizens, entrepreneurs and NGOs are involved.

### Key learnings from clustered initiatives

#### Success factors identified in clustered initiatives

Level	Success Factors in clustered initiatives
<b>Organizational and/or spatial</b>	<ul style="list-style-type: none"> <li>• Geographical proximity of 3 ecosystems: industries, applied R&amp;D and academia;</li> <li>• Development of an open technological platform for industrial scaling-up of biotechnology processes;</li> <li>• Available space to grow in the future;</li> <li>• High-efficiency infrastructures, local smart-grids and driven Industrial Symbiosis to reduce production costs in an Agro-industrial Park;</li> <li>• Driven top-down strategy to benefit from efficient Industrial Symbiosis;</li> <li>• Geographical proximity of actors of the primary sector (growers) and actors of the secondary sector;</li> <li>• Development of local areas by using old industrial sites that are de-commissioned;</li> <li>• Combining the treatment of households' waste with bioethanol and biogas plants to reuse most by-products and to lower CO<sub>2</sub> emissions;</li> <li>• Collaboration between private companies and local municipalities.</li> </ul>
<b>Technical and/or logistic</b>	<ul style="list-style-type: none"> <li>• Huge quantity of feedstock available, high storage;</li> <li>• Vertical integration via existing agro-food actors in search of value creation through non-food applications;</li> </ul>



Level	Success Factors in clustered initiatives
	<ul style="list-style-type: none"> <li>• Optimal logistic model in and out;</li> <li>• Combining a variety of energy and supply tasks in a unified system concept to optimize synergies between individual elements by making efficient use of the energy flows between the individual plants;</li> <li>• 3 different companies in charge of the 3 steps in the biogas production;</li> <li>• Development of Bio-CCP (Carbon Capture Products) in the region.</li> </ul>
<b>Economic, financial and/or marketing</b>	<ul style="list-style-type: none"> <li>• Strong and long-lasting Public-Private partnership at regional level, with a clustered and topical competitiveness approach combined with an Eco-industrial park approach leading to advanced industrial symbiosis;</li> <li>• Economies of scale in a cluster or an agro-industrial park;</li> <li>• Strong open to the world promotion strategy;</li> <li>• Co-investment in R&amp;D and demonstration plants;</li> <li>• Economic promotion of local areas through the creation of new industries, products and jobs;</li> <li>• A non-profit principle leading to maximum hedging for investors, creditors and heat costumers;</li> <li>• Use of local biomass resources based on long-term contracts for high security of supply;</li> <li>• Strategic innovation to anticipate and lead the post fossil-based economy;</li> <li>• Financial support of the European Union</li> </ul>
<b>Environmental, social and/or cultural</b>	<ul style="list-style-type: none"> <li>• Setting-up a large facility/cluster can only happen when local governments, citizens, entrepreneurs and NGOs are involved;</li> <li>• Strategic Innovation and Research Program to anticipate and lead the post fossil-based economy;</li> <li>• Hundreds of thousands of CO<sub>2</sub> equivalentents saved per year;</li> <li>• Use manure as a substitute for process water;</li> <li>• Getting national and international prizes;</li> <li>• Creation of jobs in rural areas while developing technological know-how;</li> <li>• Persisting even in situation with resistance from external parties.</li> </ul>
<b>Institutional and/or legal</b>	<ul style="list-style-type: none"> <li>• Large strategic Public-Private Partnership between the EU and the Bio-based Industries Consortium;</li> <li>• Region as “agricultural development area”, creation of conditions for business development; giving room for economic development under the condition that the processing is sustainable.</li> </ul>

**Risk or failure factors identified in clustered initiatives**

Level	Risk or failure factors in clustered initiatives
<b>Economic, financial and/or marketing</b>	<ul style="list-style-type: none"> <li>• High dependency on large investment;</li> <li>• Need to reach a critical mass for the bioeconomy “emerging” sector. Need to organize the value chains and de-risk investments;</li> <li>• Difficult to be competitive with bio-based products in a context of “too cheap” fossil-based energies.</li> </ul>
<b>Environmental, social and/or cultural</b>	<ul style="list-style-type: none"> <li>• High dependency on fossil-based energy; AgriportA7 acknowledges the risk and plans to be fully independent of fossil-based energy in the future;</li> <li>• High competition with petrol-based technologies that are produced at lower costs;</li> <li>• Resistance from NGOs.</li> </ul>
<b>Institutional and/or legal</b>	<ul style="list-style-type: none"> <li>• Fiscal incentives are critical for economic feasibility.</li> </ul>

**Key learnings from non-clustered initiatives**

**Success factors identified in non-clustered initiatives**

Level	Success factors in clustered initiatives
<b>Organizational and/or spatial</b>	<ul style="list-style-type: none"> <li>• Available local agro by-products;</li> <li>• Using local industrial by-products and sewage sludge;</li> <li>• Possibility of valorising all by-products when involving other local businesses;</li> <li>• Building an initiative on existing clusters;</li> <li>• Implant plants such as refineries next to wastewater-treatment plants to reduce energy and water consumption through resource exchange;</li> <li>• Successful collaboration between a German company and farmers in Greece;</li> </ul>
<b>Technical and/or logistic</b>	<ul style="list-style-type: none"> <li>• Anaerobic digestion is a proven technology);</li> <li>• Going from R&amp;D innovation to markets: building a long-term collaboration between the project holder, R&amp;D experts and potential clients (markets) in order to reach a completely effective, economic and commercially viable process;</li> <li>• Innovative technology allowing new processes;</li> <li>• The construction cost of small biogas plants can be reduced a lot by self-building (but plant safety and environmental safety must be ensured);</li> <li>• Possibility to use slaughterhouse by-product as a substrate for bio-gas production;</li> </ul>

Level	Success factors in clustered initiatives
	<ul style="list-style-type: none"> <li>• A large organic vegetable producer is almost energetically neutral due to energy synergies between their biogas production plant using vegetables co-products as substrate, their greenhouse and their freezing facility.</li> </ul>
<p><b>Economic, financial and/or marketing</b></p>	<ul style="list-style-type: none"> <li>• Feed-in tariff for electricity coming from anaerobic digestion;</li> <li>• Going from R&amp;D innovation to markets: having a network of strategic partners ready to invest in the next phases. i.e. industrialization;</li> <li>• Successful public-private partnership;</li> <li>• Selling the energy produced by a small biogas plant to neighbouring households;</li> <li>• To scale-up and commercialize a new marketable technology or process: identify and partner with existing multi-national and eco-innovative actors in the same field (i.e. FENC, Taiwan if you are in the fibre industry as they are an attractive partner for large brands using synthetic fibres and willing to develop greener products);</li> <li>• Designing new products that are drop-in replacements enabling full utilization of existing logistics infrastructure without blending limitations;</li> <li>• Using slaughterhouse by-product as a substrate for biogas production reduces the disposal costs and can cover a large part of electricity and heat demand;</li> <li>• Replacing toxic components with natural nontoxic products can significantly reduce some hidden costs like the recovery costs of fire extinguishers;</li> <li>• Including clients in the project management;</li> <li>• Targeting the market of conscious clients;</li> <li>• Protect innovative products with a patent makes them more stable and interesting for investors;</li> <li>• Traceability, high-quality standards and fair agriculture attract clients even if the products are a bit higher in price than conventional ones;</li> <li>• Partnership along the overall new Value Chain from the start; a solution-oriented partnership between a green building block developer and a high-tech material producer; A partnership of strengths to answer to the market demand;</li> <li>• Joint venture designed to develop strategic innovations;</li> <li>• Designing alternative processes that are more than pure alternative; for instance, processes that are bio-based but also the source of energy-savings or increased production capacity;</li> <li>• Testing all the assumptions of the business model foreseen; Staying connected to economic realities;</li> <li>• Pro-active promotion of the project to obtain permission to produce and public support;</li> <li>• Innovation capacities &amp; product portfolio extension;</li> <li>• Optimization of logistics costs;</li> </ul>

Level	Success factors in clustered initiatives
	<ul style="list-style-type: none"> <li>• Technology transfer: robust and low-cost solution designed to be implemented in developing and transition countries. Design that fits with the needs of the targeted countries;</li> <li>• Valorisation of all the new process co-products in order to be economically and environmentally optimal;</li> <li>• Global strategy in the niche market of functional textiles;</li> <li>• A vertical integration enables a strong IP and labelling strategy; this enables to build up a strong brand, facilitating cross-industry cooperation and further innovation;</li> <li>• The bio-sourced alternatives solve issues that are not solved by the fossil-based products.</li> </ul>
<b>Environmental, social and/or cultural</b>	<ul style="list-style-type: none"> <li>• Well accepted processes (energy and material recovery from pig manure) in the local context;</li> <li>• Very clean kind of fuel produced;</li> <li>• Consumers and communities are always more interested in ecological products;</li> <li>• Keeping process cost-effectiveness in mind when developing new processes; Designing the all process to reach the highest technical efficiency and thus the highest possible economic performance;</li> <li>• Transparency and traceability for an ethical and ecological production is appreciated and an important marketing argument;</li> <li>• Buying olive production by-products from local farmers avoids throwing tons of coproducts in the sea;</li> <li>• Winning prizes/awards facilitate promotion;</li> <li>• Designing for sustainability from the start;</li> <li>• Pro-active citizen awareness-raising.</li> </ul>
<b>Institutional and/or legal</b>	<ul style="list-style-type: none"> <li>• The biogas branch is supported by the states (Switzerland and EU) and the current strategy wants to support the use of alternative energies;</li> <li>• Public financial support is critical.</li> </ul>

**Risk or failure factors identified in non-clustered initiatives**

Level	Risk or failure factors in non-clustered initiatives
<b>Organizational and/or spatial</b>	<ul style="list-style-type: none"> <li>• Sufficient space (at least one hectare) is needed to set up a small biogas plant;</li> <li>• Odour emission needs to be considered (depended on the local context and the baseline) when designing the concept of a biogas plant;</li> <li>• Seasonality alters the availability of by-products; thus, stocks must be carefully planned;</li> <li>• Far away from the farmers, today farmers are not benefiting from the added value generated via the by-products.</li> </ul>

Level	Risk or failure factors in non-clustered initiatives
<b>Technical and/or logistic</b>	<ul style="list-style-type: none"> <li>• Outputs quality varies;</li> <li>• Clients do not trust a new kind of fuel;</li> <li>• Technology has never been tested on a large scale;</li> <li>• Contractors do not know and therefore do not trust an innovative product;</li> <li>• Working with fresh by-products requires an efficient logistic, but scaling-up might result into not enough (fresh) by-products available in nearby surroundings;</li> <li>• The industrialization process is a critical phase;</li> </ul>
<b>Economic, financial and/or marketing</b>	<ul style="list-style-type: none"> <li>• Public entities have high-quality standards;</li> <li>• The biogas branch relies on subsidies to be profitable;</li> <li>• Entering an existing market with a new product is challenging;</li> <li>• Bio-based structural elements are much more expensive to produce compared to those that are mass-produced;</li> <li>• There is competition between different sectors for the same agricultural by-products;</li> <li>• Difficult to open a market for pellets from digestate as single plant operator;</li> <li>• Producing barbecue briquettes from olive oil by-products is more expensive than regular wood briquettes;</li> <li>• Getting food security/safety approvals is time-consuming; it should be considered carefully in the project design and development.</li> </ul>
<b>Environmental, social and/or cultural</b>	<ul style="list-style-type: none"> <li>• Biogas plants are sometimes not “wanted” in the landscape</li> </ul>
<b>Institutional and/or legal</b>	<ul style="list-style-type: none"> <li>• Future remuneration of electricity (power) coming from anaerobic digestion;</li> <li>• Public financial support is difficult to get;</li> <li>• Change in legislation is a risk;</li> <li>• Dependency on public subsidies.</li> </ul>

### 6.3 Business model development using business model canvas

The purpose of this procedure is to assist the project partners and food businesses to identify a combination of values represented by their products, processes, services for their targeted customers and consumers; the method of creating and delivering this value; the way how they persuade their customers and consumers to pay for this value, and the mechanism how they can convert these payments into profit. The main objective of building up a specific business model to develop an attractive offer to the customers/ consumers based on the bundle of products or services and related value-adding services what the partners can deliver to them in a profitable way.

This procedure can be applied for such innovative products, processes, services and systems, and market concepts, which are based on the commercialisation of the results of research, development and innovation activities.

#### Definitions

*Business model* is a tool for identification of the distinguishable, potentially unique value, what an organisation delivers to its clients and the society and also the method how the organisation makes this available for the targeted clients and beneficiaries. Business models include further aspects of the business strategy development such as the identification of how this value is produced and how the organisation offering this value will achieve its profit.

*Resources* are assets, that an organisation can actually access and use in developing and realizing products to create value in its markets.

*Capability* is the ability to execute a repeatable pattern of actions, which are created through a company's management process for coordinating its resources in the process of value creation.

*Competencies* are substantial capabilities for enabling the organisation to deliver a fundamental customer benefit based usually on the combined, integrated and harmonised, use of resources and/or (several) capabilities.

*Core competencies* are such competencies which enable an organisation to exceed its rivals. These competencies should be: distinctive, applied better than the competitors; typical (collective) for the company across-functions, products, business units; unique, rare, difficult to imitate; flexible for continuous upgrading, reorganizing the routines, resources and capabilities.

*Partnership* is a voluntarily initiated cooperative agreement formed between two or more independent organisation to carry out a project or a specific activity jointly by coordinating the necessary competencies, capabilities, resources and activities.

#### Procedure description

The business model basically explains how the business/organisation is doing its business and helps to identify how a novelty can be created in the approach of making the business, which will make the production and/or services more attractive to the users. This concept highlights the value can be created at several elements of the business activities represented by the building blocks of the "Business Model Canvas" and the other elements should be harmonised with the value creation. It explains how value is created for the customers, how value is captured for the company and its customers and beneficiaries and how it is made available for them. This value should be potentially unique, distinguishable. A better understanding of the business model gives the organisation also insights to the relationship between what the business does and the businesses' successes, and it gives the organisation the ability to compare its business model with other competing companies



and to understand what can advantageously be changed to keep its competitive advantage on the market so that future growth of the business will continue.

An organisation’s business model can be analysed in different ways and many different tools have been developed to analyse business model concepts. However, the business model canvas tool is an intuitive way of understanding the business model concept and is a good starting point for analysing an innovative approach for making business.

The business model canvas gives a company a simple and intuitive tool to describe and think through the different elements of its business models in order to systematically challenge the way it does business and thereby be able to create new strategic alternatives. The canvas thus serves both as a tool for organisations to understand the business model and as a tool to do business model innovation.

Business models are made of 9 building blocks. The nine blocks cover four main areas: the value offer, the customers, the infrastructure and the financial viability. The main steps of developing a business model are illustrated in the next figure, following the concept of Business Model Canvas (Osterwalder & Pigneur, 2010). The development of the business model should be based on a systematic analysis of the internal strengths and weaknesses and the threats and opportunities of the business environment (like SWOT-SOR analysis).

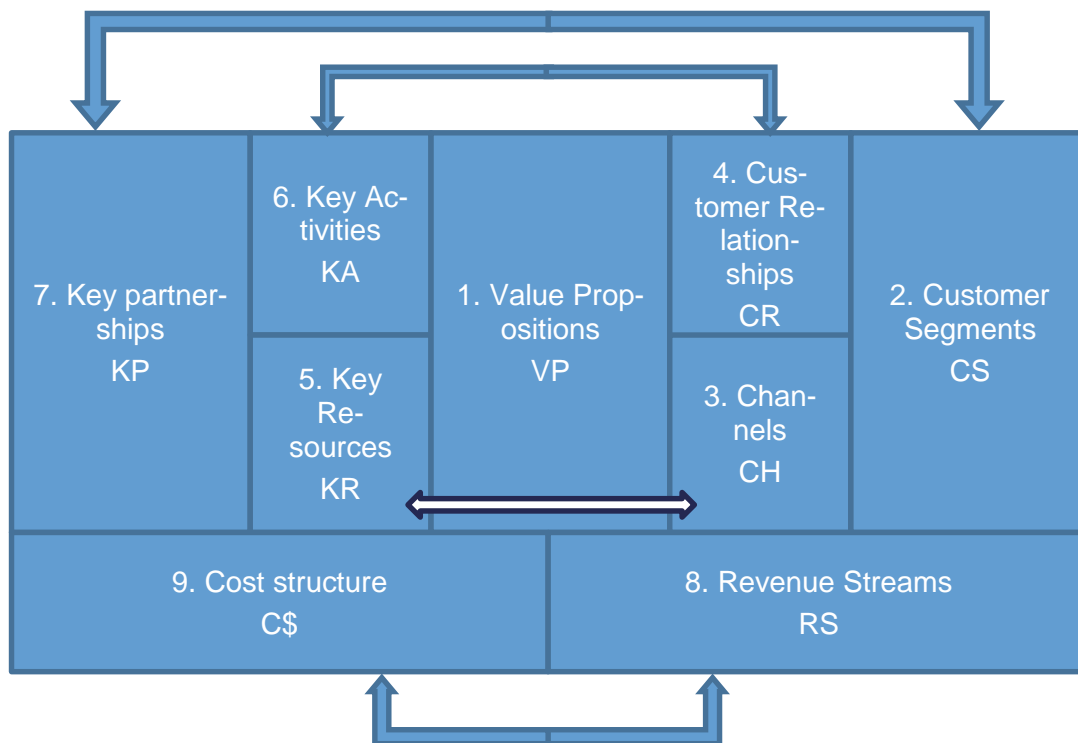

Figure 25: The main steps of developing a business model following the concept of Business Model Canvas

Source: Business Model Canvas (Osterwalder, Pigneur 2010.)

**For the implementation of the business model actions should be planned considering the necessary resources, timing and responsibilities.**

### **Define the value propositions**

A value proposition describes the aggregated benefits what an organisation offers to a specific customer/consumer segment through its bundle of products and/or related services. The management of the food business should define what do they offer to a customer/ consumer segment what these customers/consumers perceive as a solution for one of their problems or as a valuable product, function or service which satisfies one of their needs and for which they are ready to pay. The value proposition should state clearly those benefits based on performance attributes of the products, services and their complementary applications why customers/ consumers should choose this offer of the company over another offer of the competitors. It should also be defined in which phase of fulfilment of the customer needs (acquisition, use, disposal) the benefits are provided.

Define value propositions individually for each customer/consumer segment what your organisation intends to serve.

Consider typical elements which can contribute to the creation of values to a specific customer/ consumer segment:

- Newness, novelty
- Better performance
- Customisation of products and services to specific needs of customers/consumers or their segment
- Provision of related services
- Attractive design
- Brand and the status represented by it
- Price
- Enabling cost reduction
- Risk reduction
- Accessibility
- Convenience/Usability

Record your findings for this element and for all of the other ones in the Template1. Business Model Canvas.

### **Identify customer segments**

Identify distinct groups of customers and consumers which have common needs, expectations, behaviour or other attributes and what your organisation wants to reach amplest those customer/consumer groups that are most likely to be attracted by a value proposition. At identification of different segments of customers/consumers consider differences in their needs and product and service attributes perceived as a value, preferred distribution channels, expectations and requirements for different relationships, buying power, willingness to pay for different aspects of the offer. There may be other aspects of segmentation.

Typical examples of customer segments:

- Mass market
- Niche market

- Slightly segmented, slightly differing
- Diversified
- Multi-sided platform (or multi-sided markets representing a situation where two or more interdependent customer segments are served)

### **Establish distribution channels**

Define the distribution channels through which you want to communicate with your customers and make your value proposition(s) available for them. Define which channels cover the following functions.

- Raising awareness among customers/consumers about your products and services
- Helping customers/consumers to evaluate your value proposition(s)
- Allowing your customers/consumers to purchase your specific products and services
- Making your value proposition based on your products and services and their combination available to your customers/consumers
- Providing post-purchase support

You may need to use a mix of several channels to cover all necessary functions.

Consider whether the use of your own channels or partners channels can provide better access to your customers/consumers. Consider the number of contacts, profit margin, cost efficiency, financial risks. Owned channels can be direct such as own web-site, in-house sales force, etc. and indirect as own retail shops and outlets. Owned channels may enable higher profit margins, but at higher risks, usually higher costs and the access is limited to own customer/consumer population. Partner channels are indirect and may include retail stores of partners, wholesale distribution, partner-owned websites. Partner channels may allow lower profit margins, but at lower costs and lower risks and may enable access to a broader customer/consumer population based on the partners customer networks.

Define your optimal mix of channels to reach a specific customer/consumer segment.

### **Determine customer relationships**

Define how you want to attract and retain customers/consumers. Identify for each segment whether your main aim is to

- Acquire new customers/ consumers (usually through marketing)
- Retain existing customers/ consumers (usually through services)
- Add-on selling (increase the purchase of the existing customers/consumers), (usually through sales)

Analyse the nature of relationships used for delivering your offers, with each of your customer/consumer segments and identify what they expect from you to provide in this respect. Describe what interactions you are providing already which should be maintained and what you have to establish newly to meet their expectations. Consider the following typical types of customer relationships together with other options which all may coexist:

- Personal assistance
- Dedicated personal assistance
- Self- service
- Automated service

- User communities (including online ones)
- Co-creation by involving customers into the development process
- Adjustment to personal needs
- Etc.

### **Specify key resources, capabilities and core competencies**

Specify which key resources, capabilities and competencies do you need to create and offer your value proposition, reach your markets, maintain relationships with your customer/consumer segments, and earn revenues. Describe what are your main resources, capabilities and competences and define your core competencies (see definitions). Build your business model on exploiting your key resources, capabilities and core competencies.

Do not limit your thinking on your own resources, capabilities and core competencies within your company, but think beyond the company borders along your food chain. One organisation's resources/capabilities and competencies and its suppliers'/customers' complementary capabilities/resources/competencies can give the basis for a new joint core competency of that relationship. This core competency can give the business a competitive edge against its competitors.

Evaluate availability of physical (manufacturing facilities, buildings, equipment, machinery, vehicles, systems, distribution networks, etc.), intellectual (brands, reputation, proprietary knowledge, patents, copyrights, trade secrets, partnerships, databases, customer databases, etc.), human (trained, skilled, knowledgeable people within the organisation and in partnership), financial (cash, lines of credits, stock options etc.) resources and capabilities and competencies built on them.

### **Define key activities to create and offer value propositions**

Describe which interdependent key activities are required to create and offer your value proposition, reach your markets, maintain relationships with your customer/consumer segments, and earn revenues. These activities form the value configuration of your business model. Analyse and evaluate:

- Inbound logistics (purchasing, receiving, warehousing, inventory control of input – raw material, ingredients, additives, packaging material, other resources- materials;
- Production (designing, preparation, manufacturing, delivering a product in required quantity and quality by the required deadline)
- Problem solving (developing new solutions for individual customer problems, knowledge management, regular training)
- Outbound logistics (warehousing, order fulfilment, transport, etc.)
- Platform/network (establishing and maintaining matchmaking platforms or network- related activities)
- Marketing and sale (channel selection, advertising, pricing, branding, etc.)
- After-sale (customer support, repair services, etc.).

### **Identify key partnerships**

Identify who are your key partners. Consider strategic partner alliances with non-competitors, strategic partnerships with your competitors, joint ventures and buyer-supplier relationships to assure reliable supplies. Think over the motivations behind your partnerships such as optimisation and economy of scales, reduction of risk and uncertainty, acquisition of particular resources, capabilities,

competencies and activities. Describe which key resources, capabilities and competencies you receive from your partners and which activities do they perform.

Identify who are your key suppliers. Apply the approach and principles of food chain management. Describe which key resources, capabilities and competencies you receive from your suppliers.

### **Establish revenue streams**

Develop your concept how you will generate revenue. Define for what value are your customers/consumers in a customer/consumer segment really willing to pay. Establish this answer for each segment and evaluate options for several sources of revenue. List what is the value for which they are paying currently and how they pay currently. Consider how they would prefer to pay? Evaluate the contribution and importance of each revenue stream to the overall revenues.

Consider revenue options both from one-time consumer payments and recurring revenues from ongoing, repeated payments for delivering value propositions or provision of post-purchase customer support. Consider different ways to generate revenue streams including:

- Asset sale;
- Usage fee;
- Subscription fee;
- Lending/Renting/Leasing;
- Licensing,
- Maintenance and updating fee for software, books and other knowledge-based products;
- Maintenance service fee for machinery;
- Refilling

### **Define cost structure**

Specify your costs related to creating, marketing and delivering value to your customers, using resources, assets, carrying out activities, maintaining customer relationships, maintaining partner network relationships, generating revenue. Consider the most important costs, and the most expensive key resources and key activities.

Consider which basic business model cost structure is most appropriate for your approach:

- Cost driven, which focuses on minimising costs wherever possible. These are typically related to price value propositions, high level of automation and extensive outsourcing.
- Value-driven, which focuses on value creation. These are typically related to premium value propositions and a high degree of personalised services.

During describing your costs list fixed costs and variable costs and consider cost advantages which may be provided by economies of scale and economies of scope.

### **Design your business model**

Think over the findings of the analysis of the building blocks of your business model, revise and harmonise them and organise them into a coherent, realistic model.

**Use the business model as an input to your business strategy**

Integrate your business model into your business strategy. Develop an action plan for implementation.

**Roles and responsibilities**

The elements of the business model should be developed by the management of the food business with the assistance of the expert of the intermediary.

**Associated documents and record sheets**

Business Model Canvas

<p><b>7. Key partnership (KP)</b></p> <ul style="list-style-type: none"> <li>• ..</li> <li>• ..</li> </ul>	<p><b>6. Key Activities (KA)</b></p> <ul style="list-style-type: none"> <li>• ..</li> <li>• ..</li> </ul>	<p><b>1. Value Propositions (VP)</b></p> <ul style="list-style-type: none"> <li>• ..</li> <li>• ..</li> </ul>	<p><b>4. Customer Relationships (CR)</b></p> <ul style="list-style-type: none"> <li>• ..</li> <li>• ..</li> </ul>	<p><b>2. Customer Segments (CS)</b></p> <ul style="list-style-type: none"> <li>• ..</li> <li>• ..</li> </ul>
<p><b>9. Cost Structure (C\$)</b></p> <ul style="list-style-type: none"> <li>• ..</li> <li>• ..</li> </ul>	<p><b>5. Key Resources (KR)</b></p> <ul style="list-style-type: none"> <li>• ..</li> </ul>	<p><b>3. Channels (CH)</b></p> <ul style="list-style-type: none"> <li>• ..</li> <li>• ..</li> </ul>	<p><b>8. Revenue Streams (RS)</b></p> <ul style="list-style-type: none"> <li>• ..</li> </ul>	

Figure 26: Business Model Canvas



---

## 6.4 Summary of business models developed

Based on the insights from the study on business models, a summary was made by INRA. After reviewing the 33 cases from NoAW Deliverable 5.1 and studying in-depth 12 cases (6 cases from Deliverable 5.1 and 6 new cases), six types of circular business models have been identified which differ in their way of value creation strategy (from lower to higher value) and/or in their organisational structure:

1. biogas plant,
2. upcycling entrepreneurship,
3. environmental biorefinery,
4. agricultural cooperative,
5. agro park and
6. support structure (figure).

Identifying the organisational forms and types of valorisation pathways highlights the potential of using biomass firstly for higher-added-value products, before exploiting finally unused products as an energy source. However, it should be noted that in reality, many examples in the NoAW context have started as biogas type of business. Cascading biomass use becomes to play a key role in the development of a circular economy, especially at territorial levels where clusters of SMEs and start-ups seek competitive advantages. Advanced and context-dependent circular business model concepts are important for understanding the value creation mechanisms and for facilitating decisions for managers to design appropriate economic models and market entry strategies (Donner et al., 2019a), (Donner et al., 2019b), (Donner et al., 2020).

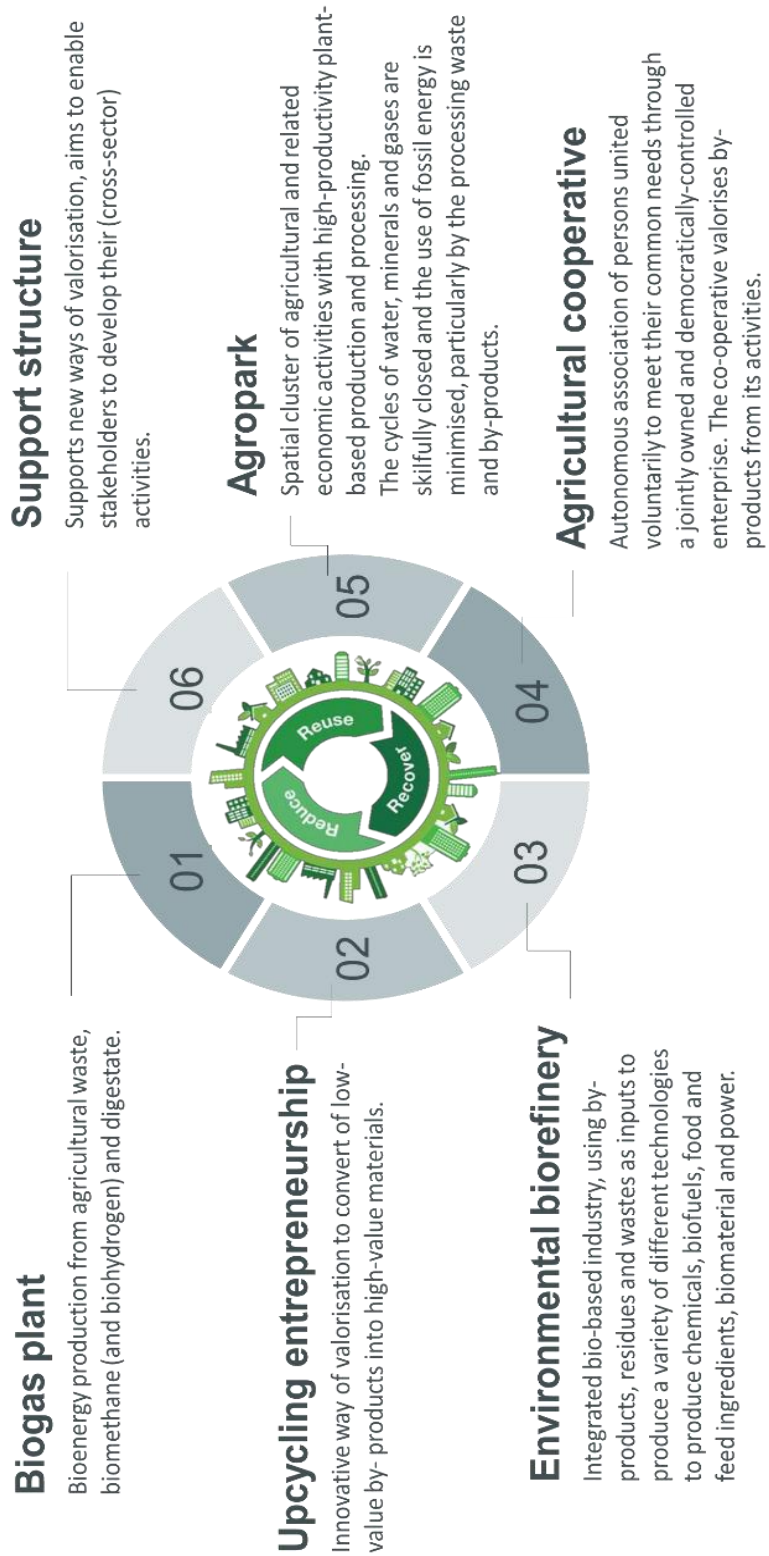

Figure 27: Typology of circular business models for valorising agro-waste and by-products

7 **Success stories** (see detailed in NoAW D5.1)

**Agriport A7, commercial enterprise/ Middenmeer, The Netherlands/ Agri(business) cluster with synergies between companies on heat, electricity, logistics, waste and in the future possibly on sidestream valorisation/ Operational example**

Agriport A7 creates synergy between agro related companies on a large-scale business park. The clustered companies are cooperating to reduce their waste and, if possible, use the waste (for example heat) of other companies.

**Key trigger for the initiative at the start (2002):** The idea was to cluster companies in the direct environment of other companies they could benefit from in terms of waste management, natural resources and logistics.

**Key objectives of the initiative at the origin:** At the beginning the focus was on logistics. During the planning process energy and water became more and more important.



*Agriport A7 is located in the 'Wieringermeer', an area in the province of North Holland, and only a 30 minutes' drive from Amsterdam. The scale of the available fields and area give an opportunity to grow. Also the climate conditions are very good for growing vegetables. And because of the clustering of related activities, the area is not isolated.*

**Key impacts:**  
Private investments in Agriport Greenhouses since 2006: € 620 million

Today, 75% of the agricultural revenues are created at 5% of the agricultural land in a business that didn't exist in the area before 2006.

Datacenter investment approximately € 2 billion

In total approximately 1500 jobs created in the Agriport area.

**Current initiative business models:**

**DATA CENTERS:**

- Central facility for storage and transfer of computer data
- High power consumption for computers and cooling
- ICT sector responsible for 7,5% of total Dutch energy consumption
- Datacenters use 2% of world wide energy production
- Energy usage doubles every six years
- Use the heat (waste) to heat up the greenhouses

**GEO THERMAL ENERGY:**

- Two doublet wells of 10 MW thermal energy per well
- Hot water (90 °C) of 2.500 m below the surface
- Heat grid throughout the Agriport area
- 20% reduction of fossile fuel usage and CO2 emissions
- First well up and running in April 2014
- Added value for companies at the business park
- Now searching for alternative CO2 supplier

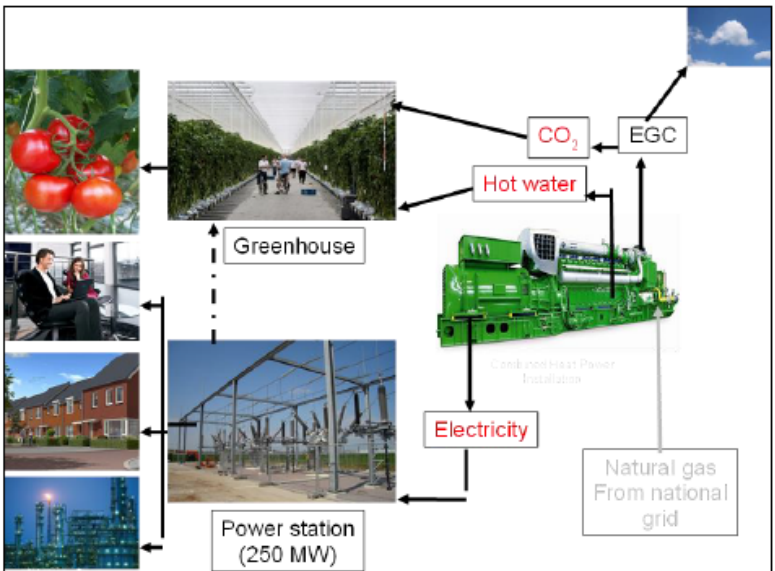

**Combined Heat Power (CHP) production:**

- Combined Heat Power installation creates electricity out of natural gas from the national gas grid.
- The surplus of electricity is transferred to the power station (250 MW) and is used by other companies and households.
- The CHP installation creates heat and CO2 as by-products. These by-products are being used in the greenhouses to increase the growth of the tomatoes and peppers.

**Agro Energie Hohenlohe GmbH & Co. KG / Kupferzell, Germany / Initiative centered around methanisation / ongoing / Non clustered -1 company involved – 100 Ha / job creation: 2**  
**FARM and INNOVATION AT METHANISATION LEVEL**



**ORIGINATION**

**Key triggers of the initiative at the origin:** Limitations to expand the farm because of nutrient application from pig slurry on land

**Key objectives of the initiative at the origin:** Additional income generation for the farm through renewable energy production, Nutrient recovery and export to other regions / sectors

**Key historical milestones between origin and today:** 2001 start of biogas plant (55 kWe), 2003 expansion (300 kWe), 2007 fertilizer production and marketing (nutrient export), 2009 heat supply to district heating grid, 2013 virtual power supply to electric car sharing initiative



**KEY IMPACTS (current)**

**Agro By-product valorized per year**  
 Animal manure & slurry, residues from food production ~20,000 t

**CAPEX**  
 Approx. 220,000 USD at origin

**2 permanent jobs created at biogas plant**

**Other impacts**  
 Renewable energy production (e.g. replacing 80,000 l heating oil), fertilizer sales / nutrient export

**KEY ACTORS & PARTNERS**

Category/Expertise	Interest(s)/influence	Responsibility in initiative
Farmer & owner	Income diversification	Initiator, main responsibility

**KEY SIDE-STREAMS VALORIZATION (Agro by-products)**

<b>By-products typology / Yearly volume / Seasonality</b>	Manures, fruit & vegetable residues / ~20,000 t / no seasonality
<b>Valorization processes / key technologies</b>	Anaerobic digestion, Digestate drying, Pelletising
<b>Maturity of technologies used</b>	Technical maturity reached
<b>Key outputs and markets</b>	Outputs: Energy (power, heat) and fertiliser Markets: local district heating grid, other farmers in Europe, Electric car sharing initiative (project)

**ORGANIZATIONAL MODEL**

<b>Governance / coordination</b>	GmbH & Co. KG (Similar Ltd. company)
<b>Shared infrastructure /</b>	-
<b>Cooperation with Science &amp; technology</b>	Research projects on nutrient recovery, environmental impacts
<b>Support mechanisms</b>	Funding for research projects

**ILLUSTRATION**

Example of cascade of valorization:



Picture: feedstock



Picture: Biogas plant



Picture: Digestate drying



Picture: Fertiliser granules

**SUCCESS & FAILURE FACTORS**

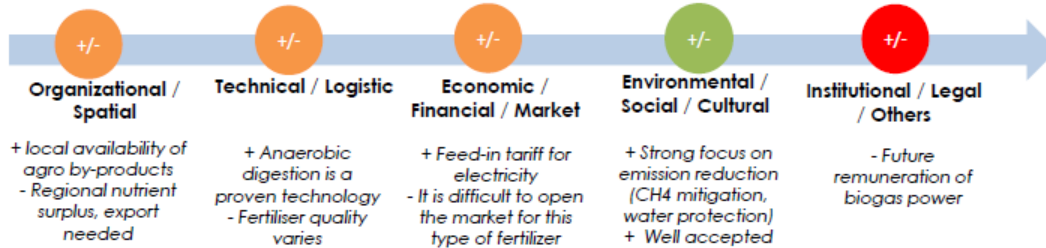

Key links: [www.nadu-naturduenger.de](http://www.nadu-naturduenger.de)



H2020 NoAW project  
 WP 5.1. International benchmark



**Biorefinery Pomacle Bazancourt/ Reims, France / Agro by-products valorization with agro-food actors up-stream and other industries downstream (energy, cosmetics) – regional scope, clustered / On-going / Current jobs: 1'200**



Picture source: [Ecolnovera\\_Bazancourt](#)

ORIGINATION

**Key triggers of the initiative at the origin:** vast agricultural area, huge bio-based feedstock, vertical integration, high willingness to collaborate to innovate.

**Key objectives of the initiative at the origin:** value creation trough non-food applications

**Key historical milestones between origin and today:** expertise in plant fractionation and bio refining, white biotechnology, bio-based chemistry and agro-materials / development of an open technological platform for industrial scaling-up of biotechnology processes / Competitiveness Cluster "Industry and Agro Resources"



**KEY IMPACTS (current)**

- Agro Waste valorized per year**  
From 1,2 to 5 million tons Sugar Beet ; From 1 million tons Wheat
- CAPEX required / TRI**  
1 billion € consolidated investment
- Job created / typology**  
1'200 for overall ecosystem
- Other impacts**  
European benchmark in bio refining

**KEY ACTORS & PARTNERS**

Category/Expertise	Interest(s)/influence	Responsibility in initiative
Regional farming cooperatives (agriculture, transformation)	Vertical integration, Create added value through non-food applications	Raw material procurement, Creation of a shared infrastructure, ARD (Agro-Industries R&D)
Foundation Jacques de Bohan	Economic development of the site, branding	Site promotion
French Ministry for Industry and Regional Institutions	French industrial competitiveness	Cluster Industry and Agro Resources , Open technological platform
Academia	Innovation	Synergies with applied research and companies

**ORGANIZATIONAL MODEL**

Governance / coordination	Mutualized infrastructure (ARD) and governance
Shared infrastructure / financing	Mutualized private Research center (ARD)
Cooperation with Science & technology	Very strong due to geographical proximity of academic actors
Support mechanisms	Competitiveness cluster, National fund to develop an open innovation platform (5 million €)

**KEY SIDE-STREAM VALORIZATION (Agro waste)**

Waste typology / Yearly volume / Seasonality	From production and transformation of wheat and sugar beet
Valorization processes / key technologies	Indirect energy and material recovery
Maturity of technologies used	A few proven applications world-wide
Key outputs and markets	Ethanol first and second generation, actives for cosmetics, bio-based acid succinic

ILLUSTRATION

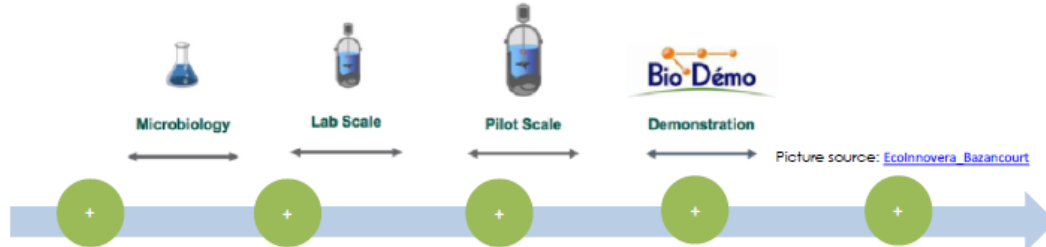

Picture source: [Ecolnovera\\_Bazancourt](#)

SUCCESS & FAILURE FACTORS

Organizational / Spatial	Technical / Logistic	Economic / Financial / Market	Environmental / Social / Cultural	Institutional / Legal / Others
Geographical proximity of 3 ecosystems : industries, applied R&d and academia	Huge quantity of feedstock available High storage capacity (1 million tons)	Strong open to the world promotion strategy (Foundation J. de Bohan) Strong private and public cooperation Advanced industrial symbiosis at park level European benchmark in biorefining		Strong public support in the long run. At the forefront of the national cluster strategy.

Key links: [Ecolnovera\\_Bazancourt](#) <http://www.a-r-d.fr/en/>

H2020 NoAW project  
WP 5.1. International benchmark

## 8 Conclusion

Above “Best-practice guidelines for farms and businesses on agricultural waste management” focused on the circular economy to turn agricultural waste into ecological and economic assets. This best practice guideline does not claim to be a definitive collection of all available solutions but introduces best practices in the light of NoAW project, with a special focus on bioplastics and solutions centered around biogas facilities.

The guide gives a short overview of the valuable raw materials in agriculture waste, with special focus on manure, straw and winery wastes. The actual potential was emphasized through quantification of the available material and the environmental challenge and potential for producing valuable products from these agricultural residues. Overview of applicable legislation for the NoAW domain was presented, and specifically focused on legislation for the feedstock and the products that are studied in the NoAW project.

We presented an overview of bio-plastics, innovative bioplastic-based materials for packaging applications, biogas production in the context of bioenergy. A new two-stage anaerobic technology for producing biohythane (a mixture of methane and hydrogen) from biogas was briefly presented as a new possible solution. The process can serve as a model for agricultural businesses on how to add new value to agricultural waste.

The guide compares conventional composting and anaerobic digestion and outlines additional physical, chemical and biological treatment methods of the digestate. Examples of best practice can also be found in the guide. A common feature of these valorisations is the production of new added value from agricultural waste.

Development of new valorisation routes is a complex process; it requires collaboration and harmonised interactions between (commonly) independent partners and multiple disciplines. Therefore, careful and systematic design of the valorisation process and planning of the activities is crucial. The guide describes a systematic approach to the analysis of wastes and losses, and helps to understand this approach with flow chart, steps and templates.

To support new initiatives in this domain, we listed success and failure factors for further processing of agricultural waste through existing case studies. The transversal learnings from these initiatives highlight that every business model is context-based. Besides, operational and costs optimization via shared infrastructures, utilities and expertise (reaching a cost-competitive production) is a must to accelerate the roll-out of the bio-based economy. Industrial symbiosis requires large volumes to get a return on investment. Industrial symbiosis requires a series of actors with different responsibilities to work (developer of networks, traders) and setting-up a large facility/cluster can only happen when local governments, citizens, entrepreneurs and NGOs are involved.

And last but not least, to promote the business success of plants producing added value from agricultural waste in the future, the Canvas business model was presented. This procedure assists a businesses to identify a combination of values represented by an intended new product, new process, service (even for those which were developed by using agricultural residues) for targeted customers and consumers; the method of creating and delivering this value; the way how to persuade customers and consumers to pay for this value, and the mechanism how they to convert these payments into profit.



## 9 References

- Bamaga OA, Verma ML, Thakur TC., 2003. Assessment of cereal straw availability in combine harvested fields and its recovery by Baling. *Agric. Mech. Asia Africa Lat. Am.*, 34:53–8.
- Beres C, C. G.-J.-S. (2017). Towards integral utilization of grape pomace from winemaking process: A review. *Waste Management*, 581–594.
- Beres C., C. G.-J.-S. (2017). Towards integral utilization of grape pomace from winemaking process: A review. *Waste Management*, 581–594.
- Bolzonella, D., Fatone, F., Gottardo, M., & Frison, N. (2018.). Nutrients recovery from anaerobic digestate of agrowaste: Techno-economic assessment of full scale applications. *J. Environ. Manag.* , 216, 111–119.
- Bundesministerium der Justiz und für Verbraucherschutz. (2017, September 2017). *Gesetze im Internet*. Retrieved 11 05, 2017, from Verordnung über die Verwertung von Bioabfällen auf landwirtschaftlich, forstwirtschaftlich und gärtnerisch genutzten Böden (BioAbfV): [www.gesetze-im-internet.de/bioabfv/index.html](http://www.gesetze-im-internet.de/bioabfv/index.html)
- Celli A., S. L. (2018). Scarti agricoli e agro-industriali: una risorsa da sfruttare per nuovi bio-polimeri nell'ambito dei progetti europei NoAW e Agrimax. *IX Congresso Nazionale AICING, Associazione Italiana di Chimica per l'Ingegneria*. Bologna, Italia.
- Commission, E. (2011 a). *Communication from the Commission to the European Parliament, the Council, The European Economic and Social Committee and the Committee of the Regions, Roadmap to a Resource Efficient Europe, COM(2011) 571 final*. Brussels, Belgium.: [http://ec.europa.eu/environment/resource\\_efficiency/pdf/com2011\\_571.pdf](http://ec.europa.eu/environment/resource_efficiency/pdf/com2011_571.pdf). Retrieved from [http://ec.europa.eu/environment/resource\\_efficiency/pdf/com2011\\_571.pdf](http://ec.europa.eu/environment/resource_efficiency/pdf/com2011_571.pdf)
- Commission, E. (2011 b). *Communication from the Commission to the European Parliament, The Council, The European Economic and Social Committee and the Committee of the Regions, A resource-efficient Europe – Flagship initiative under the Europe 2020 Strategy, COM(2011) 21*. Brussels, Belgium.
- Commission, E. (2016 a). *Circular Economy Package, Proposal for Regulation of the European Parliament and of the Council laying down rules on the making available on the market of CE marked fertilising products and amending Regulation EC No 1069/2009 and (EC) No 1107/2009*. . Brussels, Belgium.
- Commission, E. (2016 b). *Circular Economy Package, Commission staff working document, Impact Assessment, Accompanying the document Proposal for Regulation of the European Parliament and of the Council laying down rules on the making available on the market of CE marked fertilising*. Brussels, Belgium.
- Commission, E. (2016 c). *Accompanying the document Proposal for Regulation of the European Parliament and of the Council laying down rules on the making available on the market of CE marked fertilising products and amending Regulation EC No 1069/2009 and (EC) No*

- 1107/2009. Brussels, Belgium: Commission staff working document, Executive summary of the impact assessment.
- de Ridder M., d. J. (2012). *Risks and Opportunities in the Global Phosphate Rock Market Robust Strategies in Times of Uncertainty*. The Hague, The Netherlands: The Hague Centre for Strategic Studies No 17/12/12.
- Donner, M., Gohier, R., De Vries, H. (2019a). A business model typology for valorizing agro-waste and by-products. Presented at 4. International Conference on New Business Models, Berlin, DEU (2019-07-01 - 2019-07-03).
- Donner, M., Verniquet, A., De Souza, A., Broeze, J., Groot, J., Kayser, K., Gohier, R., De Vries, H. (2019b). Critical success factors for circular business models within the agricultural sector. Presented at the 4. International Conference on New Business Models, Berlin, DEU (2019-07-01 - 2019-07-03)
- Donner, M., Gohier, R., De Vries, H. (2020). A new circular business model typology for creating value from agro-waste, *Science of the Total Environment* (2020), <https://doi.org/10.1016/j.scitotenv.2020.137065>
- European Bioplastics*. (2019.). Retrieved from <http://www.european-bioplastics.org>
- Eurostat. (2015). Retrieved from <http://ec.europa.eu/eurostat>
- Eurostat. (2019). Generation of waste by waste category, hazardousness and NACE Rev. 2 activity. *Eurostat*, [http://appsso.eurostat.ec.europa.eu/nui/show.do?dataset=env\\_wasgen&lang=en](http://appsso.eurostat.ec.europa.eu/nui/show.do?dataset=env_wasgen&lang=en).
- Fuchs, W., & Drosch, B. (2010). *Technologiebewertung von Gärrestbehandlungs- und Verwertungskonzepten*. Tulln: Universität für Bodenkultur Wien.
- Gontard, N., Sonesson, U., Birkved, M., Majone, M., Bolzonella, D., Celli, A., . . . Sebok, A. (2018). A research challenge vision regarding management of agricultural waste in a circular bio-based economy . *Critical Reviews in Environmental Science and Technology*, 614–654.
- Kayser, Katrin. (2014). *Presentation: Aufbereitung und Verwertung von Gärresten aus Biogasanlagen*. Birkenfeld.
- Lokale Energie Agentur Oststeiermark. (2007). *Möglichkeiten der Gärrestbehandlung von Biogasanlagen "Technologie-Screening"*. Oststeiermark: NOEST-Kompetenzknoten Biogas.
- Ministerium für Ländliche Entwicklung, Umwelt und Landwirtschaft. (2017). *Kommunale Abwasserbeseitigung im Land Brandenburg, Lagebericht 2017*. Potsdam.
- NoAW 2020 Factsheets. (2019). Retrieved from noaw2020.eu: <http://noaw2020.eu/noaw-factsheets/>
- Osterwalder, A., & Pigneur, Y. (2010). *Business Model Generation*. John Wiley & Son inc., Hoboken, New Jersey.
- Pigneur, Y., & Osterwalder, A. (2006). Planning and development of IS, [www.elmi.uzh.ch/preview/fois/ISPlanning](http://www.elmi.uzh.ch/preview/fois/ISPlanning). FOIS.

- 
- Schung E, H. N. (2013). Uranium, the hidden treasure in phosphates. "SYMPHOS 2013", 2nd International Symposium on Innovation and Technology in the Phosphate Industry. Technical University Braunschweig - Faculty 2 Life Sciences.
- Smidt, A. (2011). *Mobility of fertiliser-derived uranium in arable soils and its contribution to uranium concentrations in groundwater and tap water*. Germany: Jacobs University.
- Someus E, P. M. (2018). Concentrated Phosphorus Recovery from Food Grade Animal Bones. *Sustainability* 2018, 10, 2349; doi:10.3390/su10072349, [www.mdpi.com/journal/sustainability](http://www.mdpi.com/journal/sustainability).
- Vannini M., M. P. (2019). From wine pomace and potato wastes to novel PHA-based bio-composites: examples of sustainable routes for full valorisation of the agro-wastes. *7th International Conference on Sustainable Solid Waste Management*. Crete: 26-29 June 2019.
- Weiland, P. (1997). *Arbeitspapier 242, Umweltverträgliche Gülleaufbereitung und -verwertung*. Darmstadt: Kuratorium für Technik und Bauwesen in der Landwirtschaft, KTBL.
- Wetter, C. (2018, 02 22). *Nährstoffaufbereitung - aktueller Stand der Wissenschaft*. Retrieved 07 24, 2019, from [www.klv-vechta.de](http://www.klv-vechta.de): <http://www.klv-vechta.de/images/stories/2018-02-20-Wetter---Nhrstoffaufbereitung.pdf>

## 10 Partners involved in the work

### Organisations:

INRAE: Institut National de Recherche en Agriculture, Alimentation et Environnement, France

UNIBO: University of Bologna, Italy

UNIROMA: University of Rome, Italy

CBHU: Campden BRI Magyarország Nonprofit Korlátolt Felelősségű Társaság, Hungary

IBBK: IBBK Fachgruppe Biogas GmbH, Germany

ECOZ: Ecozept, Germany and France

SOFIES: SOFIES, Switzerland

Terra Humana Ltd. - BIOFARM Agri Research Station (NoAW KESP member)

**Edited by:** Campden BRI Magyarország Nonprofit Kft., 2019

**Commented by:** David Bolzonella (University of Verona), Nelly Urban (GRAP'SUD Group) Anastasia Zabaniotou, prof. (Chem. Eng. Dept., Aristotle University of Thessaloniki, Greece, NoAW KESP member)

### Acknowledgements

We would like to gratefully say thank for authors and contributor organizations.

We would like to express thanks for commenting contributors for their time and effort in the commenting in the various chapters of the guideline, and who contributed with their practical knowledge and technical experience.

We are grateful also to the organizations who provided case studies and examples, and who allowed their staff to participate and generally supported our work.

The No-Agricultural Waste (NoAW) project has received funding from the European Union's Horizon2020 research and innovation program under grant agreement No 688338. We express our gratitude for founding our work.

---

## 11 FAIR Data management

Not applicable, because data sets were not used and all literature references were clearly indicated.

## 12 Annexes

### 12.1 List of Figures

Figure 1: Integrated biorefinery system that produces conventional and innovative end-products from agro-wastes [Gontard et al. 2018] .....	9
Figure 2: Share of main cereals, Eu-28, 2017 .....	10
Figure 3: Global N input from livestock manure and synthetic (chemical) fertiliser during the period 1961 – 2014.....	12
Figure 4: Asia, Regional N input from livestock manure and synthetic fertilizers, 1961-2014 .....	13
Figure 5: Europe, Regional N input from livestock manure and synthetic fertilizers, 1961-2014 .....	13
Figure 6: The evolution of the global grapes production, 2000-2018 .....	14
Figure 7: Wine production by countries, 2018 .....	15
Figure 8: : EU legislation and how it relates to the NoAW-project (non exhaustive representation) ....	17
Figure 9: Classification of bioplastics (European Bioplastics, 2019.) .....	24
Figure 10: PHA chemical structure. R1 and R2 represent variable hydrocarbon side chains; n represents the number of carbon atoms in the linear polyester structure .....	25
Figure 11: Activities developed in NoAW to valorize winery waste .....	28
Figure 12: Activities developed in NoAW correlated to the extraction of bioactive molecules from winery .....	29
Figure 13: Traditional Flow streams on biogas plants .....	30
Figure 14: Degradation steps in anaerobic digestion.....	32
Figure 15: Fully automated two-stage process for biohydrogen and methane (biohythane) production with a feeding track specially designed for solid substrates.....	33
Figure 16: Vinasse storage tank.....	34
Figure 17: Suitability of organic matter for composting or anaerobic digestion depending on water content and structure .....	36
Figure 18: Basic processes of digestate upgrading (Fuchs & Drosch, 2010) .....	39
Figure 19: Nutrient distribution in digestate .....	40
Figure 20: Pellets from Digestate (picture credits: IBBK Fachgruppe Bigoas GmbH .....	44
Figure 21: . Figure: Packaged Pellets for private Gardeners (picture credits: IBBK Fachgruppe Biogas GmbH).....	44
Figure 22: Biogas Plant Karle / Agro Energie Hohenlohe GmbH & Co. KG; blue containers in from: pilot plant fro nutrient recovery (picture credit: IBBK Fachgruppe Bigoas GmbH).....	45
Figure 23: BioPhosphate technology (Figure credit: Terra Humana Ltd.).....	47
Figure 24: BioPhosphate products (Figure credit: Terra Humana Ltd.) .....	48
Figure 25: The main steps of developing a business model following the concept of Business Model Canvas .....	71
Figure 26: Business Model Canvas.....	76
Figure 27: Typology of circular business models for valorising agro-waste and by-products .....	78



---

## 12.2 List of Tables

Table 1: Type of fertiliser and the maximum limit of Cadmium .....	20
Table 2: Typical electric and thermal efficiencies of CHPs .....	30
Table 3: Comparison between Composting and Anaerobic Digestion .....	37
Table 4: Comparison of specific costs for digestate treatment methods. (Fuchs & Drosch, 2010).....	43