



**HAL**  
open science

# Dynamical modeling of reaction networks. Application to biased signaling

Romain Yvinec

► **To cite this version:**

Romain Yvinec. Dynamical modeling of reaction networks. Application to biased signaling. Mapping Group Online Symposium, Dec 2021, Online, France. hal-03727416

**HAL Id: hal-03727416**

**<https://hal.inrae.fr/hal-03727416>**

Submitted on 19 Jul 2022

**HAL** is a multi-disciplinary open access archive for the deposit and dissemination of scientific research documents, whether they are published or not. The documents may come from teaching and research institutions in France or abroad, or from public or private research centers.

L'archive ouverte pluridisciplinaire **HAL**, est destinée au dépôt et à la diffusion de documents scientifiques de niveau recherche, publiés ou non, émanant des établissements d'enseignement et de recherche français ou étrangers, des laboratoires publics ou privés.

# Dynamical modeling of reaction networks

Application to biased signaling

Romain Yvinec

BIOS team, Physiologie de la Reproduction et des Comportements, INRAE Tours,  
MUSCA team, INRIA Saclay,  
France

Systems Biology and Networks

Reaction network formalism

Viewing reaction network and Databases

Dynamics model with reaction network

Parameter estimation

Applications

# Outline

## Systems Biology and Networks

Reaction network formalism

Viewing reaction network and Databases

Dynamics model with reaction network

Parameter estimation

Applications

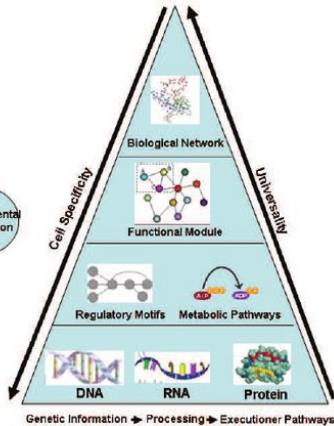
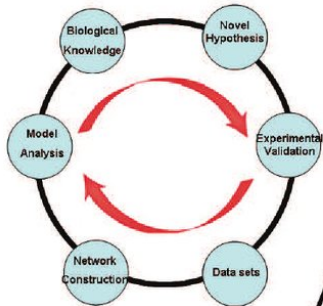

Oltvai and Barabasi, Science 25 :763-764, 2002.

# What is a network? Which network are we talking about?

A Gene regulatory network

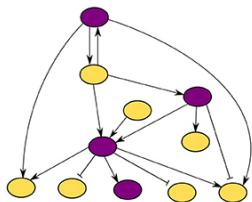

● = transcription factor   ● = gene  
→ = regulatory interactions

B Protein-protein interaction network

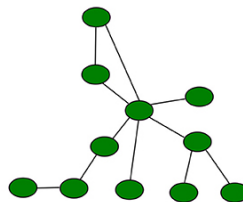

● = protein/peptide  
— = protein-protein interaction



Vandereyken et al., Front. Plant Sci., 2018.

# What is a network? Which network are we talking about?

## Small motifs

Gene Co-expression

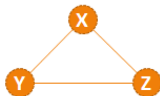

Gene Regulation

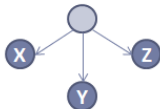
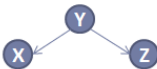

## Large networks

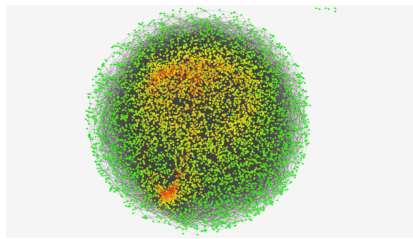

# What is a network? Which network are we talking about?

## Signaling pathways

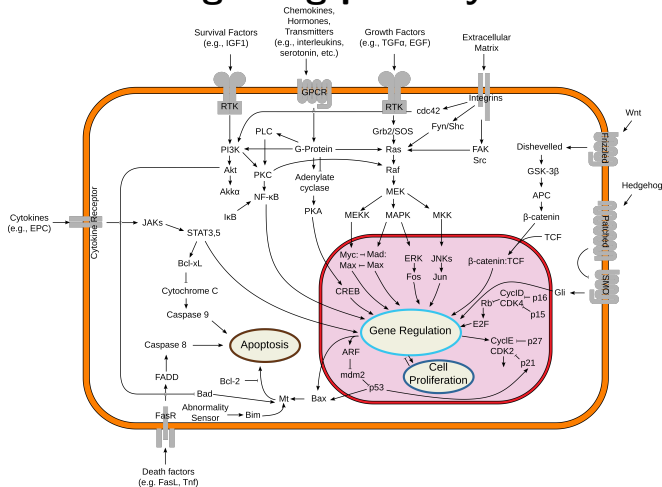



# What is a network? Which network are we talking about?

## Network, graph and reaction network

**Today :** We will deal with a specific kind of network, that have a higher degree of structure :

- ▶ Petri Nets, Species-Reaction graph, Reaction Network...
- ▶ It contains **entities** (proteins, genes, metabolites...) and **processes** that modifies the entities **abundances through time**

# Warning!

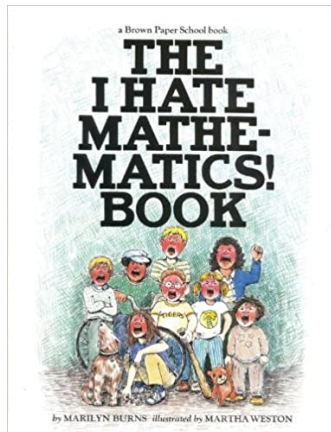

#Ihatemathematics

The following couples of slides contain some abstract notions...  
Why that?

# Maths is about structures...and is generic !

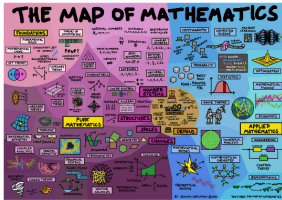

Reactions networks applications range from

- ▶ Chemistry
- ▶ molecular biology
- ▶ epidemiology
- ▶ and beyond !

## Binding experiments

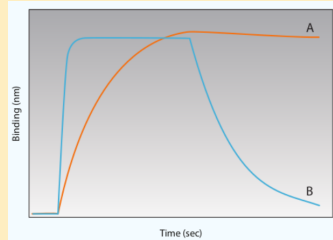

## Covid-19 models

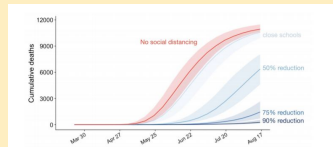

# Outline

Systems Biology and Networks

Reaction network formalism

Viewing reaction network and Databases

Dynamics model with reaction network

Parameter estimation

Applications

## Definition

A **reaction network** is given by three sets  $(\mathcal{S}, \mathcal{C}, \mathcal{R})$  :

- **Species**,  $\mathcal{S} := \{S_1, \dots, S_d\}$  : molecules that undergo a serie of chemical reactions.
- **Reactant / Product**,  $\mathcal{C} := \{y^1, \dots, y^n\}$  : Linear combination of species, that represent either 'what is consumed', or 'what is produced', in any reaction.
- **Reaction**,  $\mathcal{R} := \{y^k \rightarrow y^{k'}, y^k, y^{k'} \in \mathcal{C}\}$  : ensemble of reactions between species or combination of species (directed graph between Reactant / Product).

# Reaction Network, vocabulary

## Definition

A **reaction network** is given by three sets  $(\mathcal{S}, \mathcal{C}, \mathcal{R})$  :

- **Species**,  $\mathcal{S} := \{S_1, \dots, S_d\}$  : molecules that undergo a serie of chemical reactions.
- **Reactant / Product**,  $\mathcal{C} := \{y^1, \dots, y^n\}$  : Linear combination of species, that represent either 'what is consumed', or 'what is produced', in any reaction.
- **Reaction**,  $\mathcal{R} := \{y^k \rightarrow y^{k'}, y^k, y^{k'} \in \mathcal{C}\}$  : ensemble of reactions between species or combination of species (directed graph between Reactant / Product).
- **Mass-action law**,  $\kappa$  : a list of positive parameter (kinetic rate) for each reaction in  $\mathcal{R}$

## Example

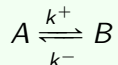

Species  $\mathcal{E} := \{A, B\}$

R / P  $\mathcal{C} := \{A, B\}$

Reaction  $\mathcal{R} := \{A \rightarrow B, B \rightarrow A\}$

Rate  $\{k^+, k^-\}$

# Reaction Network, vocabulary

Example (small cAMP production model)

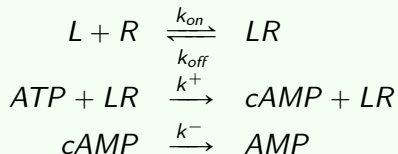

Species  $\mathcal{E} := \{L, R, LR, ATP, cAMP, AMP\}$

R / P  $\mathcal{C} := \{L + R, LR, ATP + LR, cAMP + LR, cAMP, AMP\}$

Reaction  $\mathcal{R} := \{L + R \rightarrow LR, LR \rightarrow L + R, ATP + LR \rightarrow cAMP + LR, cAMP \rightarrow AMP\}$

Rate  $\{k_{on}, k_{off}, k^+, k^-\}$



# Examples of Reaction Networks at different scales

## Small networks in Population dynamics

(Interactions between populations, Epidemiology)

### Lotka-Volterra model

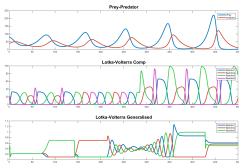
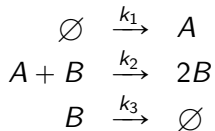

### S.I.R model

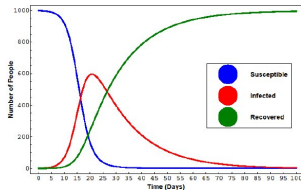
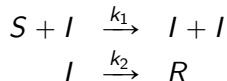

# Examples of Reaction Networks at different scales

## Small networks in molecular biology

('Toy' molecular models with isolated components)

### Enzymatic kinetics

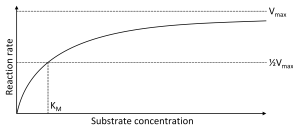
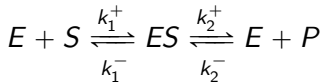

### Pharmacology model

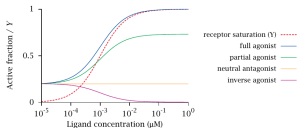
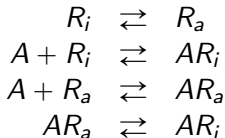

# Examples of Reaction Networks at different scales

## (Single) Gene Expression

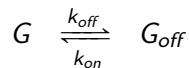
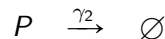
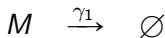
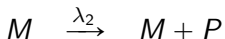
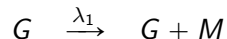

*Eldar and Elowitz (Nature 2010)*

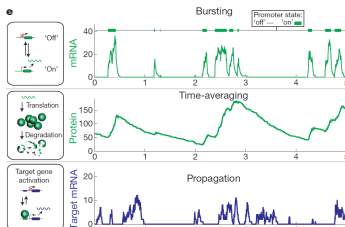
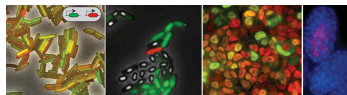

# Outline

Systems Biology and Networks

Reaction network formalism

Viewing reaction network and Databases

Dynamics model with reaction network

Parameter estimation

Applications

- ▶ List of species and reactions are not very fancy...
- ▶ We may of course use software for visualizing reaction network

# Reaction Network Visualization

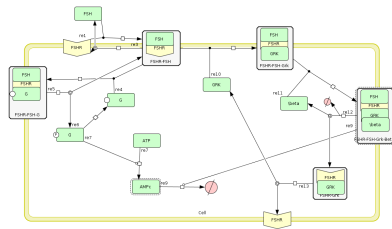
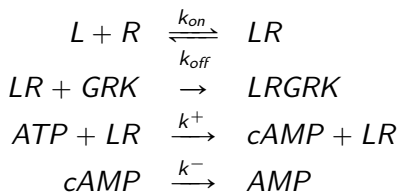

About diagrams and layout...

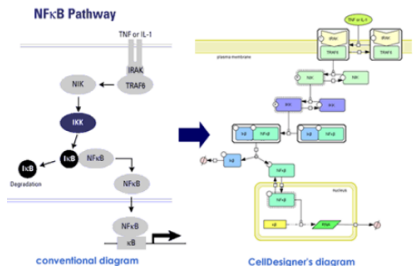

...with well-defined conventions

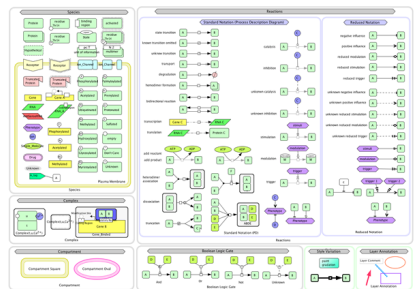

Funahashi, A., Tanimura, N., Morohashi, M., and Kitano, H.,  
CellDesigner : a process diagram editor for gene-regulatory and  
biochemical networks, BIOSILICO, 1 :159-162, 2003

# Summary so far

We have seen

- ▶ Examples of network and reaction network models
- ▶ The formalism of *reaction network* models
- ▶ How to *build* a reaction network within Cell Designer



# Summary so far

We have seen

- ▶ Examples of network and reaction network models
- ▶ The formalism of *reaction network* models
- ▶ How to *build* a reaction network within Cell Designer

NB : there exists public databases of (reaction) network models.

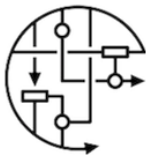

Pathguide the pathway resource list



KEGG NETWORK Database  
From gene variation to network variation

# Summary so far

We have seen

- ▶ Examples of network and reaction network models
- ▶ The formalism of *reaction network* models
- ▶ How to *build* a reaction network within Cell Designer

NB : there exists public databases of (reaction) network models.

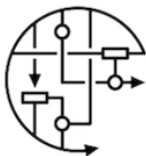

Pathguide the pathway resource list



KEGG NETWORK Database  
From gene variation to network variation

But ! Extracting reaction network from database require some care

(See  Fearnley et al. Brief Bioinform. 2014)

# Summary so far

We have seen

- ▶ Examples of network and reaction network models
- ▶ The formalism of *reaction network* models
- ▶ How to *build* a reaction network within Cell Designer

NB : there exists public databases of (reaction) network models.

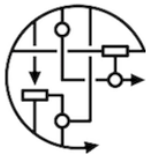

[Pathguide](#) the pathway resource list



KEGG NETWORK Database  
From gene variation to network variation

NB (bis) : A reaction network is a network... but a network is **NOT** a reaction network !

▼ Option

Scale:  100%

▼ Search

Go

▼ ID search

Go

▼ Color

▼ Network

nt06310 CRH-ACTH-cortisol sig

nt06324 CRHR-PKA-ACTH sig

nt06323 KISS1-GiRH-LH/FSH- $\epsilon$

nt06885 LHCR-GNAS-PKA  $\epsilon$  sig

nt06922 FSHR-GNAS-PKA sig

cAMP SIGNALING PATHWAY

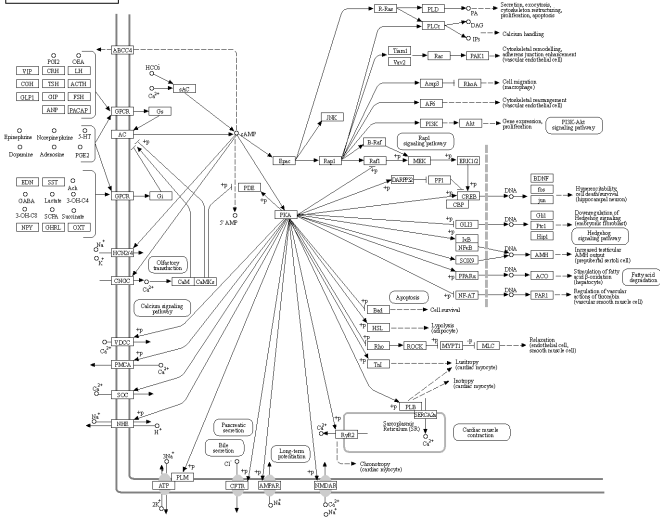

HETEROTRIMERIC G-PROTEIN SIGNALING PATHWAY-GI ALPHA AND GS ALPHA MEDIATED PATHWAY ©

Source: Signatone



Pathway Diagram Pathway Description

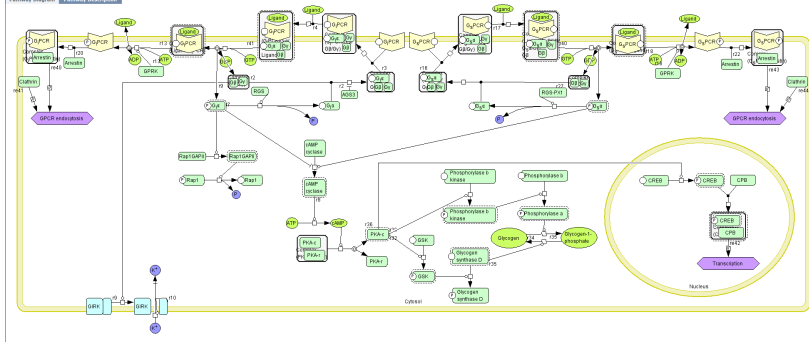

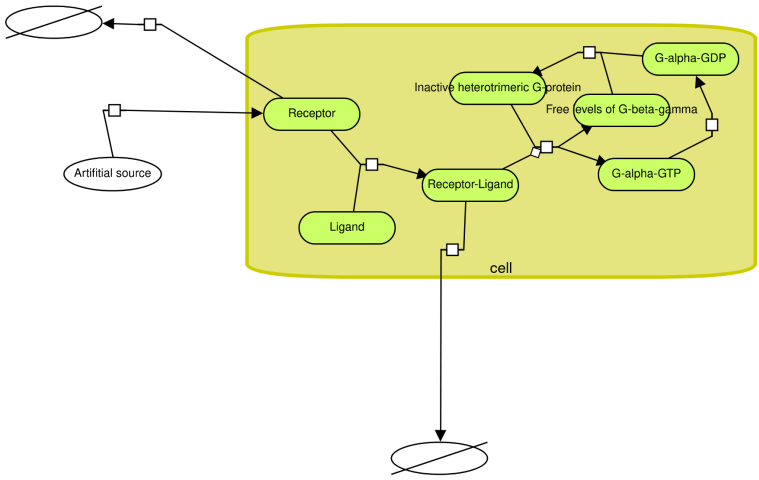

# Summary so far

We have seen

- ▶ Examples of network and reaction network models
- ▶ The formalism of *reaction network* models
- ▶ How to *build* a reaction network within Cell Designer
- ▶ **What about dynamics?**

# Outline

Systems Biology and Networks

Reaction network formalism

Viewing reaction network and Databases

Dynamics model with reaction network

Parameter estimation

Applications



# Possible applications of Dynamics modeling

- ▶ Understand non-trivial behavior of a biological system (by reproducing this behavior with an understandable model, starting from 'first principles')
- ▶ Help to identify key regulatory process in signaling cascades
- ▶ Quantify some non-observables quantities, in particular :  
molecules concentrations, reaction rates.

**Now :** Understand the mathematical formalism of dynamical reactions network

- ▶ Build and simulate a dynamical model from a reaction network [Cell Designer]
- ▶ Parameter calibration with kinetic data [GraphPad Prism / Copasi]

# Warning!

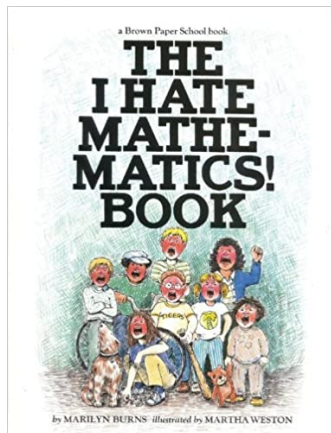

#Ihatemathematics

The following couples of slides contain some abstract notions...let's try to catch the meaning!

# Chemical Reaction Network and Dynamical models

We build a model that

- Keep track of **concentration** of species along **time**.
- Satisfy **Law of Mass action** : The velocity of a reaction is proportional to the concentrations of its reactants.
- Is a system of Ordinary Differential Equations, in which reactions are "added" on top of each other, e.g. they happens **continuously** and **simultaneously** (*Rate equations*).

## Example

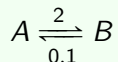

$$\frac{dx_A}{dt}(t) = -0.1x_A(t) + 2x_B(t), \quad x_A(t=0) = A_{tot}$$

$$\frac{dx_B}{dt} = +0.1x_A(t) - 2x_B(t), \quad x_B(t=0) = 0$$

$x_A(t)$  = time dependent concentration of species A

## Example

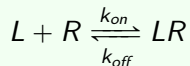

$$\begin{aligned}\frac{dx_L}{dt}(t) &= -k_{on}x_L(t)x_R(t) + k_{off}x_{LR}(t), & x_L(0) &= Dose \\ \frac{dx_R}{dt}(t) &= -k_{on}x_L(t)x_R(t) + k_{off}x_{LR}(t), & x_R(0) &= R_{tot} \\ \frac{dx_{LR}}{dt}(t) &= k_{on}x_L(t)x_R(t) - k_{off}x_{LR}(t), & x_{LR}(0) &= 0.\end{aligned}$$

# Chemical Reaction Network and Dynamical models

Example (minimal cAMP production model)

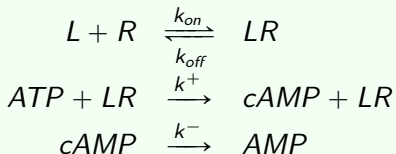

$$\begin{aligned}\frac{dx_L}{dt} &= -k_{on}x_Lx_R + k_{off}x_{LR}, & x_L(0) &= Dose \\ \frac{dx_R}{dt} &= -k_{on}x_Lx_R + k_{off}x_{LR}, & x_R(0) &= R_{tot} \\ \frac{dx_{LR}}{dt} &= k_{on}x_Lx_R - k_{off}x_{LR}, & x_{LR}(0) &= 0 \\ \frac{dx_{cAMP}}{dt} &= k^+x_{ATP}x_{LR} - k^-x_{cAMP}, & x_{cAMP}(0) &= 0 \\ \frac{dx_{ATP}}{dt} &= -k^+x_{ATP}x_{LR} & x_{ATP}(0) &= ATP_{tot}.\end{aligned}$$

# But what is an "Ordinary Differential Equation"? A math theory in one slide!

The equation

$$\frac{dx}{dt} = v(x),$$

is numerically solved by successive time-step iteration, of small length  $\Delta t \ll 1$  :

- 1) Start at a given initial condition  $x_0$  at time  $t_0 = 0$



# But what is an "Ordinary Differential Equation"? A math theory in one slide!

The equation

$$\frac{dx}{dt} = v(x),$$

is numerically solved by successive time-step iteration, of small length  $\Delta t \ll 1$  :

- 1) Start at a *given initial condition*  $x_0$  at time  $t_0 = 0$
- 2) To calculate the value of  $x$  at the first time step, remember that (*assuming constant speed*)

Final Position = Initial Position + velocity \* Time ,

which becomes, in mathematical notations,

$$x(\Delta t) = x_0 + v(x_0) * \Delta t ,$$

# But what is an "Ordinary Differential Equation"? A math theory in one slide!

The equation

$$\frac{dx}{dt} = v(x),$$

is numerically solved by successive time-step iteration, of small length  $\Delta t \ll 1$  :

- 1) Start at a given initial condition  $x_0$  at time  $t_0 = 0$
- 2) To calculate the value of  $x$  at the first time step, remember that (*assuming constant speed*)

Final Position = Initial Position + velocity \* Time ,

which becomes, in mathematical notations,

$$x(\Delta t) = x_0 + v(x_0) * \Delta t ,$$

**Iterate** : To calculate the value of  $x$  at the next time step, use

$$x((i + 1) * \Delta t) = x(i * \Delta t) + v(x(i * \Delta t)) * \Delta t ,$$

But what is an "Ordinary Differential Equation"? A math theory in one slide...and a figure!

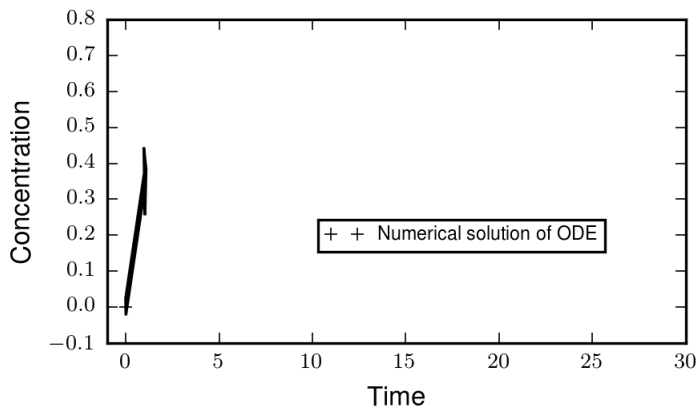

Figure – Solving an ODE

But what is an "Ordinary Differential Equation"? A math theory in one slide...and a figure!

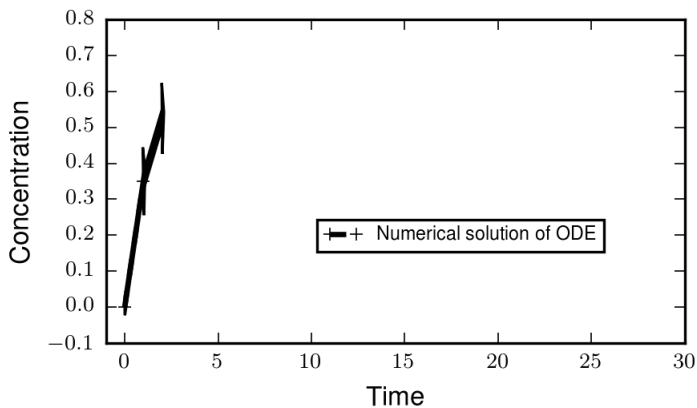

Figure – Solving an ODE

But what is an "Ordinary Differential Equation"? A math theory in one slide...and a figure!

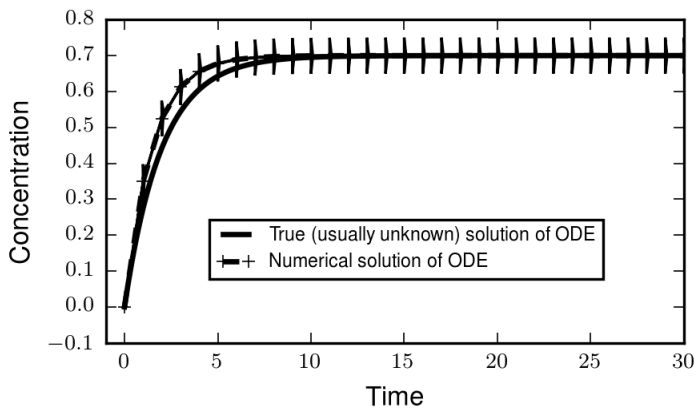
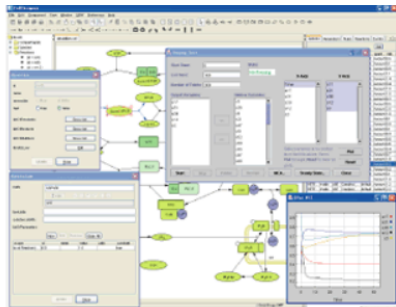
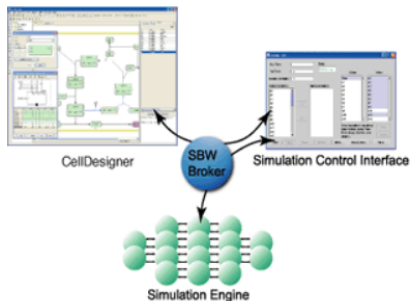

Figure – Solving an ODE

# Solving an ODE in practice : no need to code !

## ODE solver within Cell Designer



Funahashi, A., Tanimura, N., Morohashi, M., and Kitano, H.,  
CellDesigner : a process diagram editor for gene-regulatory and  
biochemical networks, BIOSILICO, 1 :159-162, 2003

# Summary so far

We have seen

- ▶ Examples of network and reaction network models
- ▶ The formalism of *reaction network* models
- ▶ How to *build and simulate* a reaction network within Cell Designer

# Summary so far

We have seen

- ▶ Examples of network and reaction network models
- ▶ The formalism of *reaction network* models
- ▶ How to *build and simulate* a reaction network within Cell Designer

NB : You don't need to code, but you need to specify kinetic rate and initial condition values to simulate a reaction network.



# Summary so far

We have seen

- ▶ Examples of network and reaction network models
- ▶ The formalism of *reaction network* models
- ▶ How to *build and simulate* a reaction network within Cell Designer

NB : You don't need to code, but you need to specify kinetic rate and initial condition values to simulate a reaction network.

NB (bis) : You can play with this tools to "explore" the behavior of a model. But that can be time consuming and inefficient...

# Summary so far

We have seen

- ▶ Examples of network and reaction network models
- ▶ The formalism of *reaction network* models
- ▶ How to *build and simulate* a reaction network within Cell Designer

**What about inferring those values from data ?**

# Outline

Systems Biology and Networks

Reaction network formalism

Viewing reaction network and Databases

Dynamics model with reaction network

**Parameter estimation**

Applications

# Parameter and network inference in Chemical Reaction Network

**Goal :** Given some time series data, find the minimal (biologically plausible) reaction network with its parameter (=reaction rates and initial conditions) that fits consistently the data.

# Parameter and network inference in Chemical Reaction Network

**Goal :** Given some time series data, find the minimal (biologically plausible) reaction network with its parameter (=reaction rates and initial conditions) that fits consistently the data.

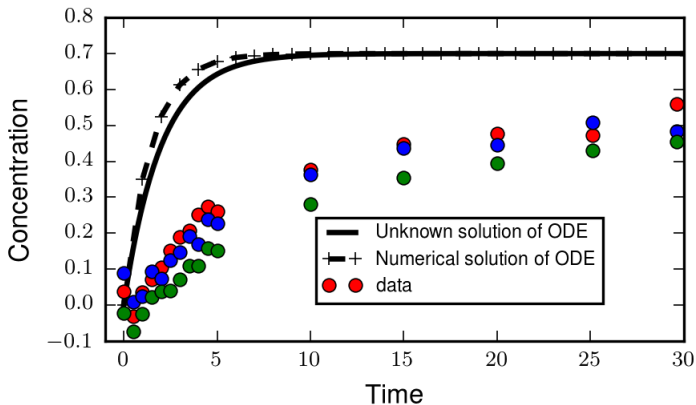

# Parameter and network inference in Chemical Reaction Network

**Goal :** Given some time series data, find the minimal (biologically plausible) reaction network with its parameter (=reaction rates and initial conditions) that fits consistently the data.

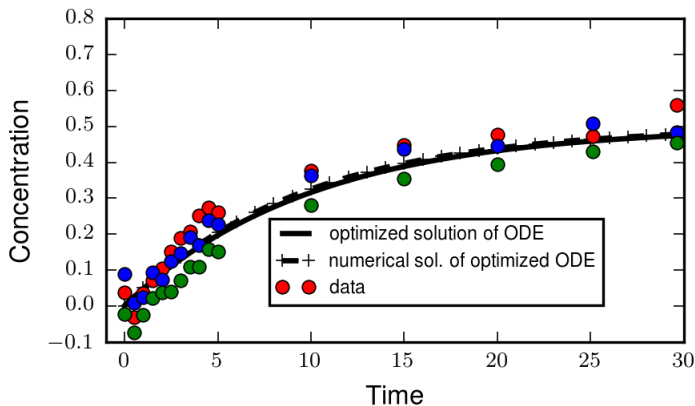

# Regression analysis and Parameter estimation with time series : What is difficult ?

- ▶ In linear models, there exists a *unique optimal* solution
- ▶ Yet in practice, (generalized) linear models do not perform well on biochemical data due to **Heteroscedasticity** and **highly dependent time point** data.

# Regression analysis and Parameter estimation with time series : What is difficult ?

- ▶ For most of (nonlinear) reaction network, there is no guarantee to find a unique optimal solution.
- ▶ Reaction network models allows to perform multifactorial analysis ("Anova-like")



# Regression analysis and Parameter estimation with time series : What is difficult ?

- ▶ For most of (nonlinear) reaction network, there is no guarantee to find a unique optimal solution.
- ▶ Reaction network models allows to perform multifactorial analysis ("Anova-like")
- ▶ Many other tools exists from the statistical field of *time series analysis*.

# Warning!

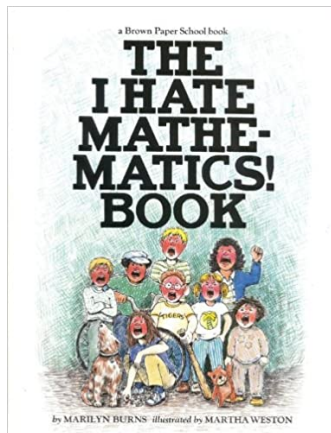

#Ihatemathematics

The following couples of slides contain some abstract notions...*but that the last ones!*

# Parameter and network optimization in Chemical Reaction Network

**Goal :** Given some time series data, find the minimal (biologically plausible) reaction network with its parameter (=reaction rates and initial conditions) that fits consistently the data.

**Strategy** 1) From a given network  $(\mathcal{S}, \mathcal{C}, \mathcal{R})$ , with given parameter values, solve the ODEs,

$$\frac{dx}{dt} = v(x, k), \quad x(0) = x_0,$$

and compute a **distance** between the solution and the data.

# Parameter and network optimization in Chemical Reaction Network

**Goal :** Given some time series data, find the minimal (biologically plausible) reaction network with its parameter (=reaction rates and initial conditions) that fits consistently the data.

**Strategy** 1) From a given network  $(\mathcal{S}, \mathcal{C}, \mathcal{R})$ , with given parameter values, solve the ODEs,

$$\frac{dx}{dt} = v(x, k), \quad x(0) = x_0,$$

and compute a **distance** between the solution and the data.

**Strategy** 2) Using **optimization** algorithms, find the best parameter values  $k, x_0$ , to minimize the distance

# Parameter and network optimization in Chemical Reaction Network

**Goal :** Given some time series data, find the minimal (biologically plausible) reaction network with its parameter (=reaction rates and initial conditions) that fits consistently the data.

**Strategy** 1) From a given network  $(\mathcal{S}, \mathcal{C}, \mathcal{R})$ , with given parameter values, solve the ODEs,

$$\frac{dx}{dt} = v(x, k), \quad x(0) = x_0,$$

and compute a **distance** between the solution and the data.

**Strategy** 2) Using **optimization** algorithms, find the best parameter values  $k, x_0$ , to minimize the distance

**Strategy** 3) If needed, change the reaction network (add or delete species/reactions)

# Parameter and network optimization in Chemical Reaction Network

**Goal :** Given some time series data, find the minimal (biologically plausible) reaction network with its parameter (=reaction rates and initial conditions) that fits consistently the data.

**Statistics** There exists a well developed statistical theory to assess the **quality of a fit** and to give **confidence interval** on parameter values (-> See Likelihood maximization or Bayesian statistics).

## Parameter estimation in



## Predefined or user-defined time-dependent equations

### Model

Radioligand=HotNM\*1e-9  
Kob=[Radioligand]\*Kon+Koff  
Kd=Koff/Kon  
Eq=Bmax\*radioligand/(radioligand + Kd)  
Association=Eq\*(1-exp(-1\*Kob\*X))  
YatTime0 = Eq\*(1-exp(-1\*Kob\*Time0))  
Dissociation= YatTime0\*exp(-1\*Koff\*(X-Time0))  
Y=IF(X<Time0, Association, Dissociation) + NS

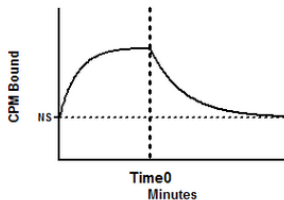

## Parameter estimation in



- ▶ Limited to *solvable* models
- ▶ Adapted to analyze one single output at a time, assuming excess of Ligand.

Pharmechanics

Pharmacology Data Analysis  
and Consulting

HOME DATA ANALYSIS CURVE FITTING CONSULTING ABOUT CONTACT

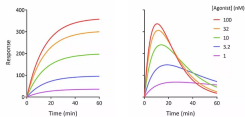

Hoare et al., Analyzing kinetic signaling data for G-protein-coupled receptors, Scientific Reports 10(1) :12263 2020

## Predefined or user-defined time-dependent equations

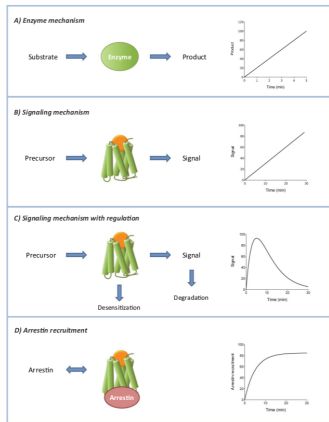



# Parameter estimation in Copasi

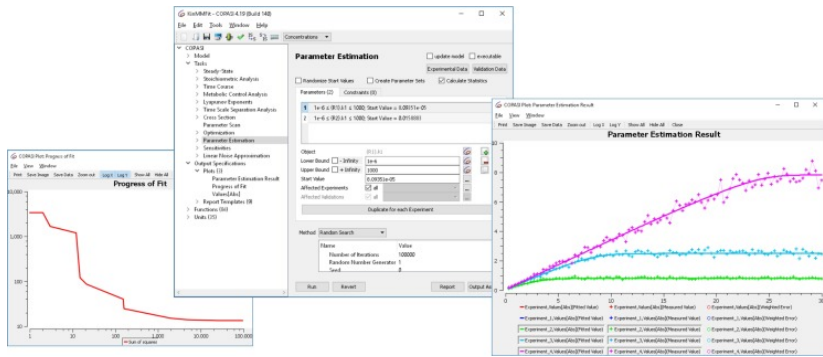

- ▶ Models can be imported from Cell Designer.
- ▶ Supports both graphical interface and command line.



Bergman et al. COPASI and its applications in biotechnology, Journal of Biotechnology 261 :215-220, 2017.  
Hoops et al. COPASI : a Complex PATHway Simulator. Bioinformatics 22 :3067-74, 2006.

# Remember! it's an iterative and interdisciplinary workflow!

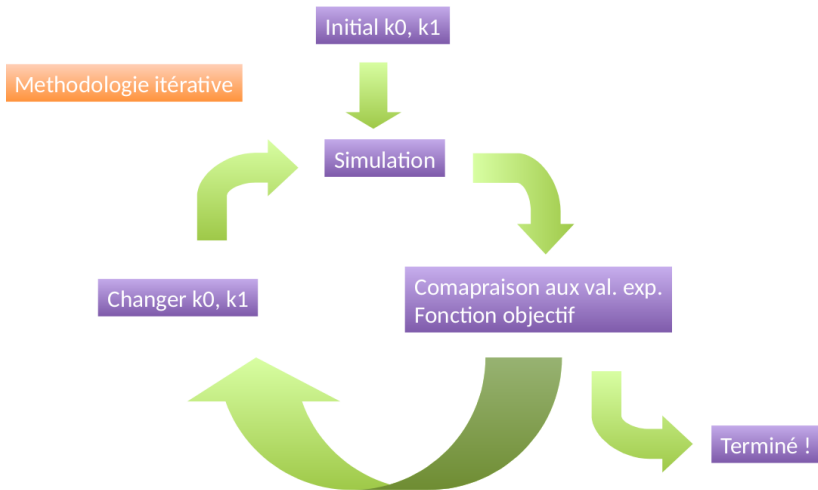

Remember! it's an iterative and interdisciplinary workflow!

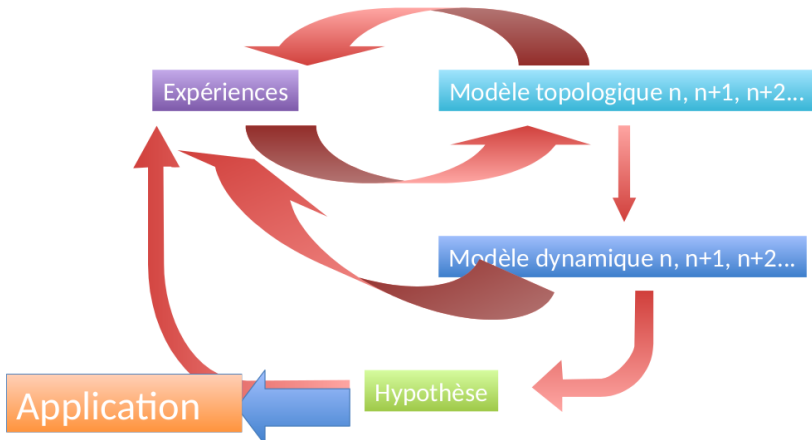

# Is the monkey who typed Hamlet actually a good writer ?

## Overfitting

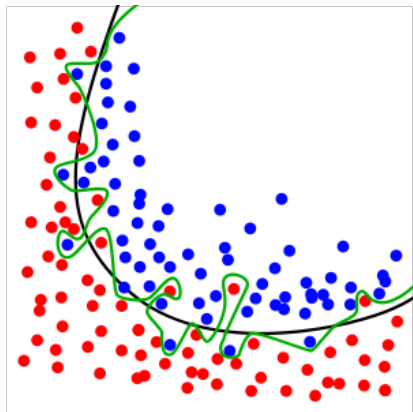

- ▶ There is a trade-off between toy minimal models and detailed biochemistry pathways.
- ▶ Overfitting leads to **unreliable** prediction and **meaningless** model / parameter value.
- ▶ (Advanced) statistical tools exist to sort this out : **model selection** (especially for hierarchical models) and **parameter identifiability**.

# Summary so far

We have seen

- ▶ Many examples of dynamical system biology models
- ▶ The formalism of dynamical reaction network models
- ▶ How to build and simulate a reaction network model within Cell Designer.
- ▶ How to calibrate parameters of a dynamical reaction network model with GraphPad Prism and/or Copasi.

# Summary so far

We have seen

- ▶ Many examples of dynamical system biology models
- ▶ The formalism of dynamical reaction network models
- ▶ How to build and simulate a reaction network model within Cell Designer.
- ▶ How to calibrate parameters of a dynamical reaction network model with GraphPad Prism and/or Copasi.

NB : The full workflow can be long and require collaboration with statistician / applied mathematician.

# Summary so far

We have seen

- ▶ Many examples of dynamical system biology models
- ▶ The formalism of dynamical reaction network models
- ▶ How to build and simulate a reaction network model within Cell Designer.
- ▶ How to calibrate parameters of a dynamical reaction network model with GraphPad Prism and/or Copasi.

NB bis : **What about applications ?**

# Outline

Systems Biology and Networks

Reaction network formalism

Viewing reaction network and Databases

Dynamics model with reaction network

Parameter estimation

**Applications**



# Motivations and Case study

Use **reaction network modeling** (*kinetic pathway*) to

- Fully exploit kinetic data
- Give more mechanistic insight of **signaling bias**
- Develop a parsimonious and **statistically significant** framework to characterize pharmacological ligand properties

# Motivations and Case study

Use **reaction network modeling** (*kinetic pathway*) to

- Fully exploit kinetic data
- Give more mechanistic insight of **signaling bias**
- Develop a parsimonious and **statistically significant** framework to characterize pharmacological ligand properties

## Case study on FSHR

- ★ 5 BRET sensors : NES-Venus mG, yPET-  $\beta$ -arrestin 2, Camyel
- ★ FSH + 6 LMW compounds (Benzamides, Thiazolidinone, Chromenopyrazole, Imidazole) (TocopheRx, Burlington, VT, USA).

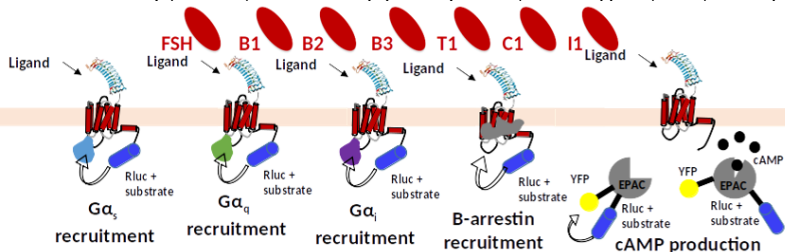



Francesco De Pascali

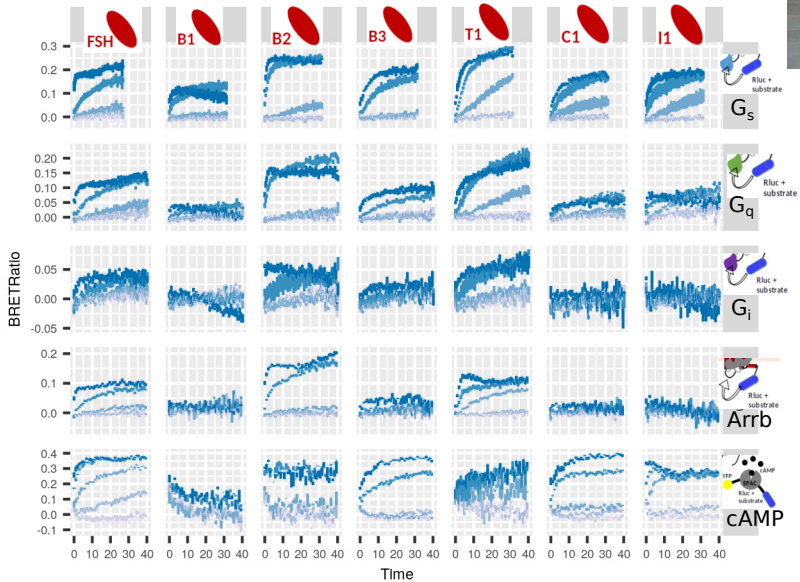

De Pascali et al. Pharmacological Characterization of Low Molecular Weight Biased Agonists at the Follicle Stimulating Hormone Receptor, IJMS, 2021.

# Operational model with A.U.C

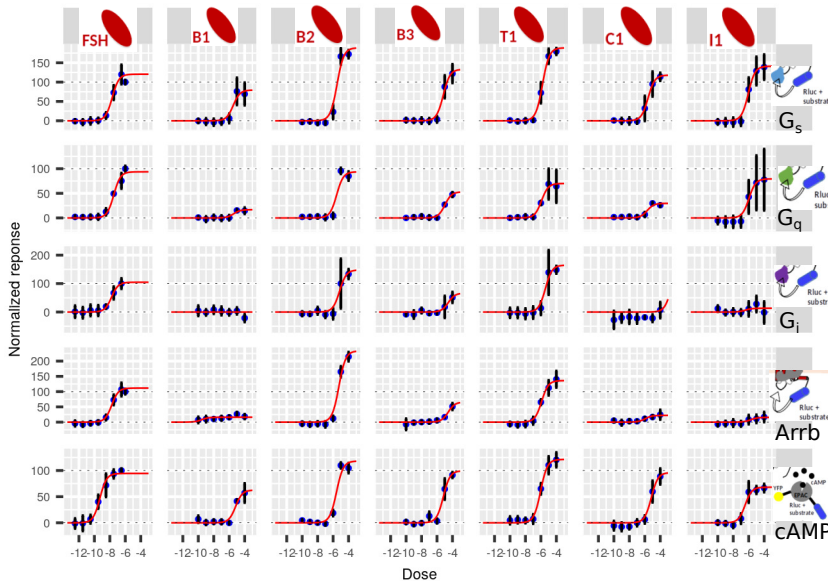

# Operational model with A.U.C

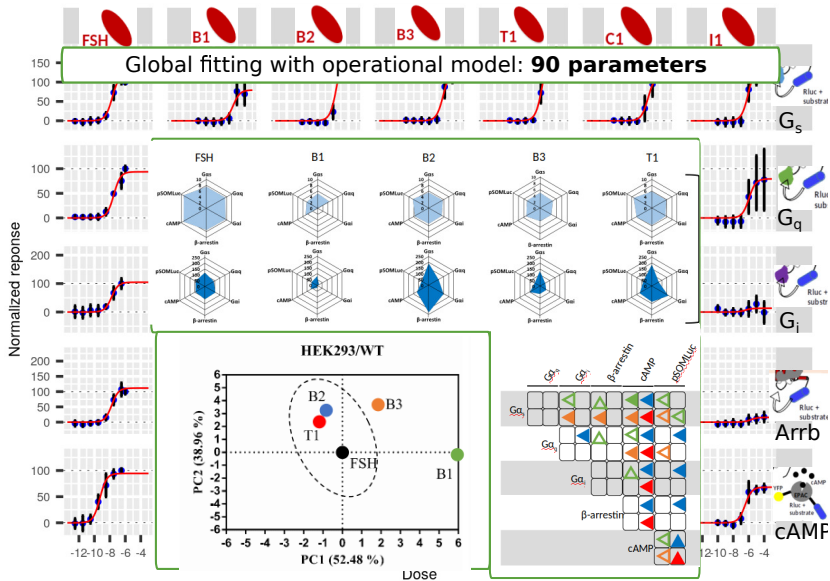

# Reaction network : multiple Pathways modeling

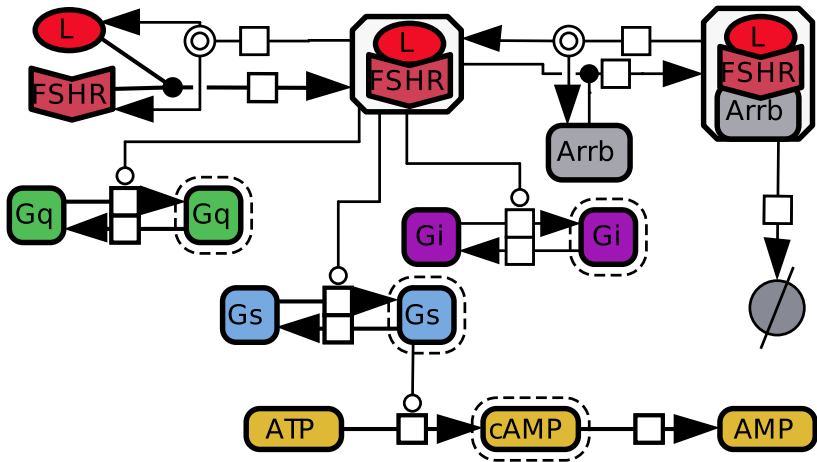

## Generate all pathways at once

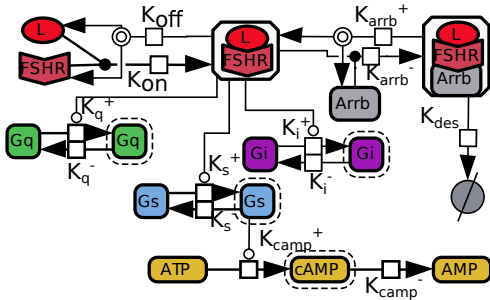

- Dynamic reaction networks (ODE) keep track of **concentration** of each molecule along time.
- Parameters : **initial quantity** of molecules and **kinetic rates** (13).

## Mechanistic link with data

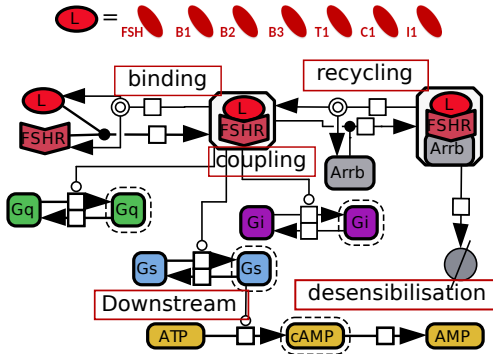

We hypothesize that

- Kinetic rate values reflects **pharmacological ligand properties**.
- Measurements are performed in a same cellular context.
- Measurements are **proportional** to concentration of molecules.



## Mechanistic link with data

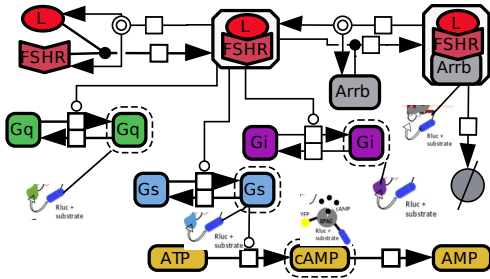

We hypothesize that

- Kinetic rate values reflects **pharmacological ligand properties**.
- Measurements are performed in a same cellular context.
- Measurements are **proportional** to concentration of molecules.

## Signaling profile diversity

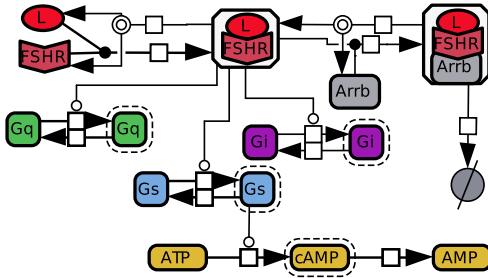

- The model is "minimal" (*model selection criteria*)
- We generalize recent attempts to define a "kinetic operational model" (Watch Nicola Dijon's flash presentation)



Hoare et al., Analyzing kinetic

signaling data for G-protein-coupled receptors,

Scientific Reports 2020

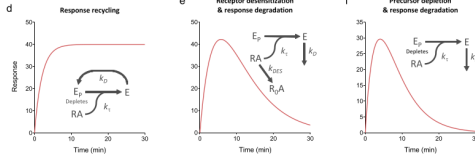

## Global fitting enforcing sparsity

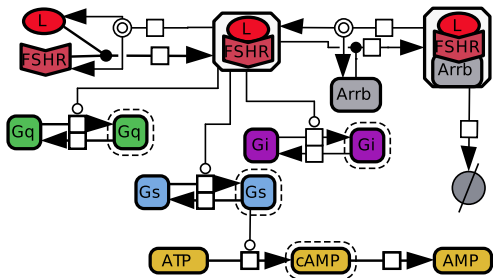

- Our method is a global fitting approach (all pathways, all ligand).
- We enforce Ligand specific parameters through penalization.



Raue et al., Data2Dynamics : a modeling environment tailored to parameter estimation in dynamical systems,

Bioinformatics 2015



Steiert et al., L1 regularization facilitates detection of cell type-specific parameters in dynamical systems, Bioinformatics 2016

# Can we really infer parameter from kinetic data ?

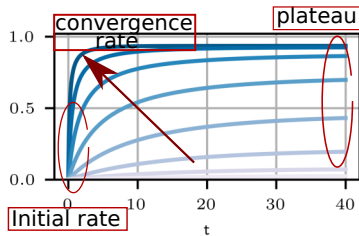
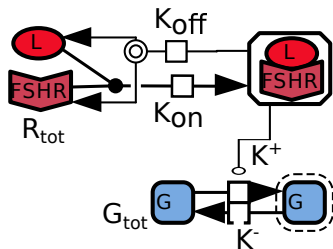

- Initial rate

$$\frac{1}{2} R_{tot} G_{tot} k_{on} k^+ [L] t^2$$

- Equilibrium

$$\frac{R_{tot} G_{tot} [L]}{K_A + (R_{tot} + K_E) [L]}$$

- Convergence rate

$$k^+ \frac{R_{tot} [L]}{K_A + [L]} + k^-$$

$$K_A = \frac{K_{off}}{K_{on}}, K_E = \frac{K^-}{K^+}$$

# Can we really infer parameter from kinetic data ?

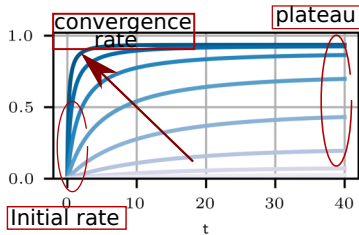
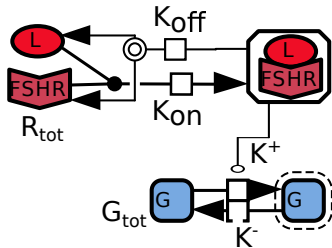

- Initial rate  
 $\frac{1}{2} R_{tot} G_{tot} k_{on} k^+ [L] t^2$
  - Equilibrium  $\frac{R_{tot} G_{tot} [L]}{K_{A+} (R_{tot} + K_E) [L]}$
  - Convergence rate  
 $k^+ \frac{R_{tot} [L]}{K_{A+} [L]} + k^-$
- In practice the global fitting improves parameter identifiability.
- Low doses and long time signal are important.

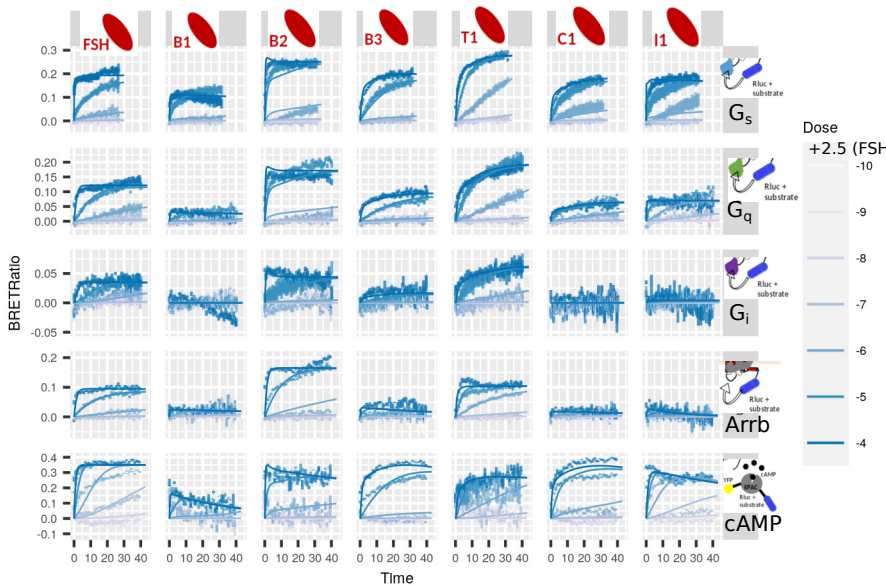



"FSH" cluster

Higher affinity  
smaller "kinetic efficacy"

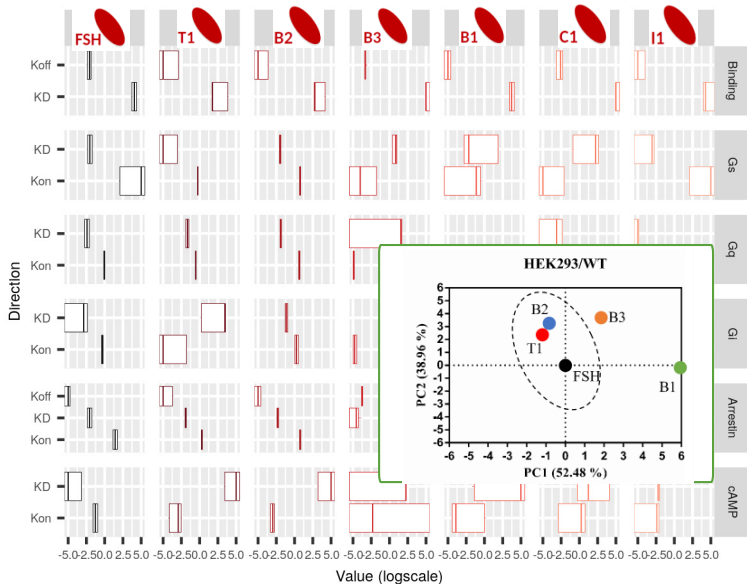

Ligand

FSH

T1

B2

B3

B1

C1

I1



# Conclusions

- ▶ Dynamical reaction network framework has many different applications.
- ▶ Its a powerful framework to reveal comprehensive spatio-temporal patterns behind signaling pathways complexities.
- ▶ Its a powerful framework to analyze quantitatively time series data in signaling pathways.
- ▶ Adequate tools foster necessary interdisciplinary collaborations by providing a common language.

# Some applications : Understanding G protein activation cycle

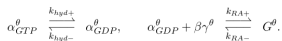
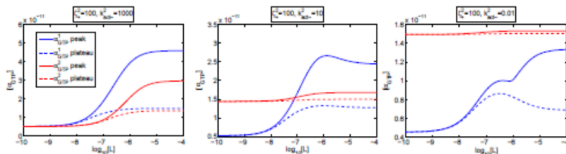

Bridge, Meads, Frattini, Winfield, Ladds, Modelling and simulation of biased agonism dynamics at a G protein-coupled receptor, *J. Theoret. Biol.* 442 :44–65, 2018

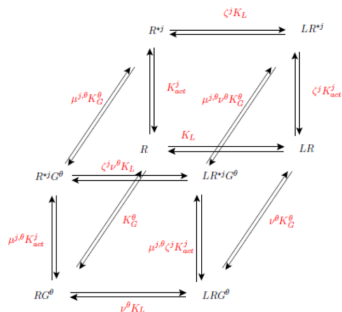

# Some applications : Shedding light on GPCR-induced Calcium oscillations in Astrocytes

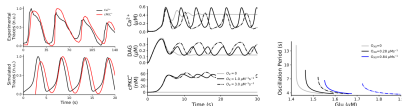
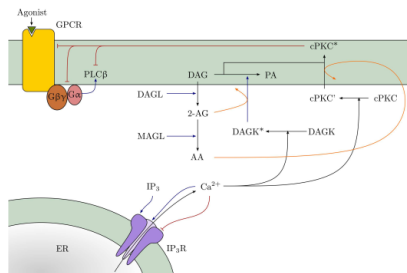

De Pittà, Ben-Jacob, Berry, G protein-coupled receptor-mediated calcium signaling in astrocytes, in Computational Glioscience, Springer 2019.