



HAL
open science

Downscaling the APSIM crop model for simulation at the within-field scale

Daniel Pasquel, Davide Cammarano, Sébastien Roux, Annamaria Castrignanò, Bruno Tisseyre, Michele Rinaldi, Antonio Troccoli, James A Taylor

► **To cite this version:**

Daniel Pasquel, Davide Cammarano, Sébastien Roux, Annamaria Castrignanò, Bruno Tisseyre, et al.. Downscaling the APSIM crop model for simulation at the within-field scale. *Agricultural Systems*, 2023, 212, pp.103773. 10.1016/j.agsy.2023.103773 . hal-04229132

HAL Id: hal-04229132

<https://hal.inrae.fr/hal-04229132>

Submitted on 5 Oct 2023

HAL is a multi-disciplinary open access archive for the deposit and dissemination of scientific research documents, whether they are published or not. The documents may come from teaching and research institutions in France or abroad, or from public or private research centers.

L'archive ouverte pluridisciplinaire **HAL**, est destinée au dépôt et à la diffusion de documents scientifiques de niveau recherche, publiés ou non, émanant des établissements d'enseignement et de recherche français ou étrangers, des laboratoires publics ou privés.



Distributed under a Creative Commons Attribution 4.0 International License

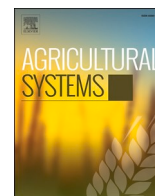

Downscaling the APSIM crop model for simulation at the within-field scale

Daniel Pasquel^{a,*}, Davide Cammarano^b, Sébastien Roux^c, Annamaria Castrignanò^d,
Bruno Tisseyre^a, Michele Rinaldi^e, Antonio Troccoli^e, James A. Taylor^a

^a ITAP, Univ. Montpellier, INRAE, Institut Agro, Montpellier, France

^b Department of Agroecology, iClimate, CBIO, Aarhus University, Tjele, Denmark

^c MISTEA, Univ. Montpellier, INRAE, Institut Agro, Montpellier, France

^d Department of Engineering and Geology (InGeo), Gabriele D'Annunzio University of Chieti-Pescara, Chieti, Italy

^e CREA Research Centre for Cereal and Industrial Crops, Foggia, Italy

HIGHLIGHTS

- Spatialization is of great interest to use crop models in precision agriculture.
- Spatial calibration efficiently down-scaled APSIM at the within-field scale.
- Spatial calibration performed best when modeling spatially structured variables.
- Ancillary data used in downscaling need to be correlated with the target variable.
- Better formalism of spatial processes improves spatialized crop model performance.

GRAPHICAL ABSTRACT

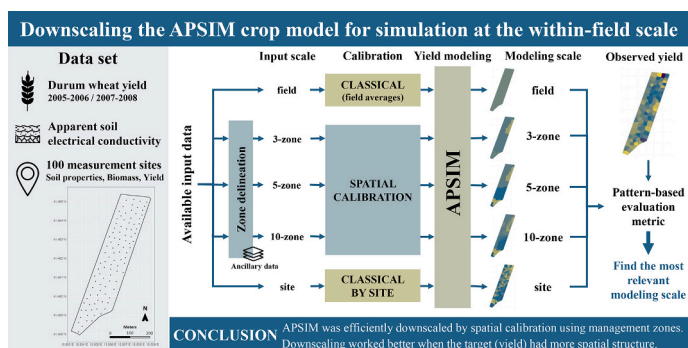

ARTICLE INFO

Editor: Mark van Wijk

Keywords:

Spatialization
Precision agriculture
Spatial calibration
Durum wheat yield

ABSTRACT

CONTEXT: Most crop models are designed for point-based modeling and to simulate agronomic variables on their native spatial footprint, i.e. typically as a uniform field-scale value. Precision agriculture needs crop model simulations at sub-field scales to support differential management application. Spatialization processes are used to change the simulation scale of crop models.

OBJECTIVE: The objective of this study is to investigate the spatialization of a complex crop model by using a spatial calibration approach to modify its native spatial footprint and to evaluate if it is relevant to use this kind of crop model at the within-field scale.

METHODS: APSIM was spatialized to simulate durum wheat yield at different spatial scales (field, within-field and site-scale) on an experimental field under Mediterranean conditions in southern Italy. Ancillary soil data were used to derive potential management (modeling) zones at different scales, which were then used to spatially calibrate soil and biomass parameters in APSIM to spatially predict yield in two different production years (one year was used for calibration and the other for evaluation). Spatialized crop model performances were evaluated using the spatial balanced accuracy (SBA) score, a metric to evaluate the global preservation of patterns between maps.

* Corresponding author.

E-mail address: daniel.pasquel@inrae.fr (D. Pasquel).

<https://doi.org/10.1016/j.agsy.2023.103773>

Received 8 June 2023; Received in revised form 8 September 2023; Accepted 20 September 2023

Available online 29 September 2023

0308-521X/© 2023 The Authors. Published by Elsevier Ltd. This is an open access article under the CC BY license (<http://creativecommons.org/licenses/by/4.0/>).

RESULTS AND CONCLUSIONS: The spatial structure of the yield data influenced the effectiveness of the spatial calibration process. When the agronomic variable (durum wheat yield) was spatially structured, a spatialized APSIM approach performed best (5-zone modeling scale, SBA = 0.17) and outperformed the field-scale (native footprint) model (SBA = 0.19). In contrast, when the target agronomic variable was more random (less spatially structured), the uniform field-scale modeling performed best and spatial calibration had no benefit. The spatialized APSIM performances were mainly based on the reliability of the delineated zones that undeniably affected the quality of the spatialized model outputs. Thus, more research is needed on how best to model scale-dependent processes to have more reliable modeling at the within-field scale.

SIGNIFICANCE: Based on the example of a complex crop model like APSIM, this study showed that spatial calibration can be effective and has a role to play in the spatialization of complex crop models.

1. Introduction

Precision agriculture (PA) represents an opportunity to use site-specific management to increase input efficiency and reduce agriculture's environmental footprint (Khanal et al., 2017; van Evert et al., 2023). In this context, spatial decision support tools (DSTs) are important to help farmers to adapt their cultural practices in a spatially and temporally uncertain environment to increase resource efficiency and maximize sustainability in time and space (Jones et al., 2017). Crop models, especially mechanistic crop models, can be useful DSTs because they can take into account various variables (e.g. climatic conditions, soil properties, management options) that affect production. For this reason, mechanistic crop models are widely used to simulate various 'what-if' scenarios and to describe and understand how some factors (e.g. environment, weather conditions, etc.) may affect crop growth and development.

Most existing crop models simulate agronomic variables (e.g. wheat yield, vine water status, fruit nutrient content) on their native spatial footprint, i.e. the spatial footprint on which they were initially designed (e.g. plant, field, region scale) (Pasquel et al., 2022a). Crop models in current use are generally designed for modeling at the field-scale and they simulate agronomic variables by using homogeneous (average) field conditions (You et al., 2022). Even if the modeling is at the field-scale, such models are referred to as point-based models because they simulate agronomic variables at a specific spatial scale over a spatial footprint that is considered a homogeneous spatial modeling unit (Heuvelink et al., 2010). However, simulating agronomic variables at the field-scale is no longer sufficient to tackle the issues arising in the agronomic and modeling communities related to PA applications. The incorporation of crop models into PA applications is shifting the use of crop models from long-term strategic uses to short-term in-season tactical (and spatial) uses. Spatialization processes are used to change the simulation scale of crop models (Pasquel et al., 2022a). The concept of spatialization is not new and has previously been well defined by Faivre et al. (2004) in order to be able to use crop model at scales other than their native spatial footprint, particularly at larger scales to predict at regional, national and global scales. The use of these crop models in PA assumes a spatialization process that simulates agronomic variables at a finer scale than the field-scale. This way of modeling at the within-field scale for PA will be directly related to the spatial pattern of the agronomic variable. Therefore, the relevance of using such crop models at finer spatial scales will be dependent of the considered agronomic variable and its spatial distribution.

Many studies, mostly linked to the impact of climate change on crop production, have used crop models at a larger scale than their native spatial footprint. Thus, the most common form of crop model spatialization has been achieved by using upscaling methods to simulate agronomic variables at regional, national or even international scales (Asseng et al., 2018; Challinor et al., 2009; Villa et al., 2022). Most upscaling methods of applied crop models are performed on a defined grid and the crop model is run using the grid points (or pixels) as the modeling unit. Each modeling unit is individually calibrated (Hochman and Horan, 2018; van Ittersum et al., 2013). In crop-climate ensemble

model studies, approximately half of the studies have used an upscaled data aggregation crop model approach, even if these crop models were initially designed at the field scale (Challinor et al., 2017). Others studies, using statistical crop models based on historical datasets, have aimed to upscale crop models to larger spatial scale (e.g. national scales) to predict the impact of climate change on crops (Lobell et al., 2008). In contrast, there have been very few studies investigating crop model uses on spatial scales smaller than their native spatial footprint, i.e. down-scaled crop modeling processes. Despite this, the spatialization of crop models at a within-field scale is of great interest for PA purposes to both model and manage within-field spatial variability.

Within-field spatial variability is well-known to be highly significant to production and is caused by local interactions between several spatially variable biotic (e.g. pests, soil microorganisms) and abiotic (e.g. soil properties, weather conditions, anthropogenic consequences, topography) factors (Corwin and Lesch, 2005). Within-field production variability can be mapped by remote and/or proximal sensing data (Jin et al., 2018; Weiss et al., 2020; Zhang and Kovacs, 2012). To tackle spatial variability, fields can be divided into within-field management zones, i.e. sub-field areas that tend to have more homogenous production characteristics. Commonly in these studies, observed data are aggregated at selected within-field zone scales. Some studies have spatialized crop models by downscaling processes based on this management zone concept (Basso et al., 2001; Cammarano et al., 2021; Leo et al., 2023), which are also known in modeling terms as 'functional units' (Launay and Guerif, 2005). In this approach, the intent is to model a zonal response. The same kind of approach, by segmenting the modeling extent by simulation zone partitioning, has also been applied on upscaling studies at larger spatial scales than the native spatial footprint of existing crop models (Guo et al., 2018; Zhuo et al., 2022). Of the published works in this area, most have focused on data assimilation approaches, whereby observed spatial data sets are used to update or replace intermediates/variables within the model (Jin et al., 2018). A common example of this is the use of remotely sensed imagery as a surrogate for LAI (or biomass/vigor) within a crop model (Hu et al., 2019; Huang et al., 2019; Jin et al., 2018). Alternatively, ancillary data could be used within a spatial calibration approach to locally correct/adjust model parameters. The aim of spatial calibration is to calibrate model parameters that are likely to vary spatially based on the delineation of within-field zones that are representative of the spatial pattern of the agronomic variable. This can be done using in-season information using a data assimilation approach or, in a more classical sense, spatial calibration could be performed *a priori* (pre-season) using historical data sets. In either case of spatial calibration, the spatial pattern is hypothesized to determine the number of delineated within-field zones on which to perform the spatial calibration.

Spatial calibration studies performed *a priori* are much less common than forcing data assimilation studies, but they have the advantages of allowing the production to be modeled (and potentially managed) from day one of the season. This is in contrast to data assimilation approaches that need crop development and data collection/processing to occur before the data assimilation and crop model spatialization can be performed. One previous study of downscaling by the spatial calibration of

crop model parameters using historical (rather than in-season data) was effectively performed on a relatively simple crop model (Pasquel et al., 2022b), WaLIS (Celette et al., 2010). The WaLIS model is a simple model to simulate water partitioning between the vine and cover crop using water balance equations and vine and cover crop growth equations. However, the most commonly used crop models in agriculture are more detailed and complex than WaLIS, involving more equations and inputs to better account for atmosphere-soil-plant water movements and crop physiology (Soltani and Sinclair, 2015). Examples of such models include STICS (Brisson et al., 2003, 2002, 1998), DSSAT (Hoogenboom et al., 2021, 2019; Jones et al., 2003), APSIM (Holzworth et al., 2014), AquaCrop (Hsiao et al., 2009; Raes et al., 2009; Steduto et al., 2009), WOFOST (de Wit et al., 2019), MONICA (Nendel et al., 2011) or Daisy (Abrahamsen and Hansen, 2000; Hansen et al., 2012, 1991). To date, to the authors' knowledge, there has been no published work on how a spatial calibration approach to downscaling would (or could) perform with these complex mechanistic crop models at the within-field scale. The spatial calibration approach advocated previously by Pasquel et al. (2022b) ran the spatialized crop model on a modeling unit by modeling unit scale while maintaining a spatial consistency at the within-field scale through the delineation of within-field zones. Thus, Pasquel et al.'s (2022b) approach to spatial calibration was not at a predefined grid/pixel size, but informed by the zoning of existing and relevant data. The transfer of this approach to a much complex crop model using real-world data for validation represents one of the main innovations of this study.

Most crop models, whether simple or complex, are based on the assumption that the model parameters are homogenous over the spatial footprint that they are run on, regardless of the spatial scale. All model parameters exhibit no spatial variability, i.e. they are aspatial parameters, regardless of the type of model parameter. Moreover, they are commonly tested at the field-scale (Zhen et al., 2023). Thus, in a PA context, it is important to test the relevance of these crop model assumptions when applied at the within-field scale. For instance, if the same wheat cultivar is sown in a field, model plant parameters are not expected to change spatially. However, other model parameters relating to water and energy balances or soil dynamics, which are known to be spatiotemporally variable, would be expected to change spatially. The objective of this study is to investigate the spatialization of a complex crop model by using spatial calibration to modify crop model resolution (spatial footprint) for PA purposes. The crop model APSIM was selected for this study because it is a well understood model among the co-authors and meets the above requirements of being a more detailed and complex crop model. This is realized by (i) using ancillary data and a segmentation algorithm to delineate within-field zones, and (ii) spatially calibrating certain model parameters at different resolutions defined by these within-field zones. The purpose is to better understand how a complex crop model responds to such a spatialization process (i.e. spatial calibration) and whether within-field scale modeling is relevant using a spatially calibrated crop model. This study represents an exploratory and preliminary work to understand how a complex crop model could work regarding a change in spatial modeling scale.

2. Materials and methods

2.1. Site description and collected data

A 12 ha experimental field of CREA (Research Centre for Cereal and Industrial Crops), near Foggia (41.462°N, 15.506°E), south-eastern Italy was used in this study. This site has previously been used for comparing the performance of crop models under conditions of varying within-field soil properties in Wallor et al. (2018). Briefly, data in the original study were collected over three production seasons (2005–2006, 2006–2007 and 2007–2008) with durum wheat (*Triticum durum* Desf. cv. Gargano) grown in all three seasons. However, the 2006–2007 year was drought affected (poor subsoil moisture at the start

of the season and low rainfall during the crop season) with very low yields recorded. Since 2006–2007 was atypical, the decision was made not to use these data in this study. The rationale for this was that the production conditions in 2006–2007 were likely to be at the limit or beyond that for which the APSIM model was designed. It is not a drought model. Spatialization of a model operating under known sub-optimal conditions was considered to be of little value as the source of any errors and effects would be ambiguous, i.e. would an observed effect in 2006–2007 be caused by modeling under drought conditions or by the model spatialization? For the other two years, meteorological conditions were typical of a Mediterranean climate, i.e. hot and dry summer (May to September) with precipitation concentrated in the autumn-winter period that coincides with cool-cold temperatures (October to April). Precipitation (P), minimum and maximum temperatures (T_{\min} and T_{\max} respectively) and solar radiation (S_{rad}) were recorded daily at a weather station 300 m from the experiment field (Fig. 1). Rainfall patterns of both growing seasons were different and 2007–2008 was identified as a drier growing season. The experimental field is located on a wide plain ('Tavoliere' that means flat table) so weather conditions were assumed to be homogeneous over the whole field. Management practices for the two considered years are reported in Table 1 and were applied uniformly on the whole field (see Wallor et al. (2018) for more details). Phenological stages were recorded for each year at seedling growth, tillering, flowering and ripening. Site-specific yield was recorded for each harvest using a John Deere combine equipped with a yield monitoring system that was calibrated prior to harvest. For these two production seasons, the mean harvested yields were similar, but they exhibited different spatial structures (Fig. 2). In 2005–2006, the yield was spatially structured within-field, while in 2007–2008, it was more random across the whole field, as shown by the shape of variogram model as pure nugget effect (Fig. 2d). The soil is a deep silty-clay Vertisol of alluvial origin, classified as a Fine, Mesic, Chromoxerert (IUSS Working Group WRB, 2015). Lateral water redistribution at the within-field scale was assumed to be negligible in this flat landscape. Soil properties were measured within-field at 100 optimized georeferenced sites in order to obtain an even spatial distribution (Buttafuoco et al., 2010) (Fig. 3A). For this study, only the values of crop lower limit (CLL) and drained upper limit (DUL), resulting from texture measurements on the shallow soil layer (0–0.2 m) and computed using a pedotransfer function (Hollis et al., 2012), along with measured soil organic carbon (OC), at the same 100 locations and at the same depth, were used. Aboveground biomass and soil water content (TDR measurements) were measured at each of the 100 measurement locations, each year, at harvest and during the growing season.

A soil apparent electrical conductivity (EC_a) survey was performed in 2010 using an electromagnetic induction ground conductivity meter (EM38DD, Geonics, Ltd., Ontario-Canada). The EC_a was simultaneously measured in two polarization modes that explored different depths depending mostly on soil moisture conditions and textural properties (Sudduth et al., 2001). The EM38DD was set up to provide a depth of exploration equivalent to the topsoil layer in the horizontal mode (EC_aH , maximum EC_a sensitivity at 0–0.10 m) and to the expected, typical rooting depth in the vertical mode (EC_aV , maximum EC_a sensitivity at ~0.40 m depth) (Fig. 3B).

2.2. APSIM and modeled durum wheat yield

Durum wheat yield was modeled using the crop model Agricultural Production Systems sIMulator - APSIM 7.14 (Holzworth et al., 2014) through the *apsimx* R package (Miguez, 2022) in R 4.2.0 (R Core Team, 2022). APSIM required soil properties as input for different soil layers, and for this study it was decided to define soil input up to a depth of 2 m (for the entire soil profile). However, observed soil properties were only available for the first 0.20 m. Therefore, subsoil soil properties needed to be estimated. To do this, the soil profile was first divided into seven layers to ensure the correct functioning of the ground modeling (Fig. 4).

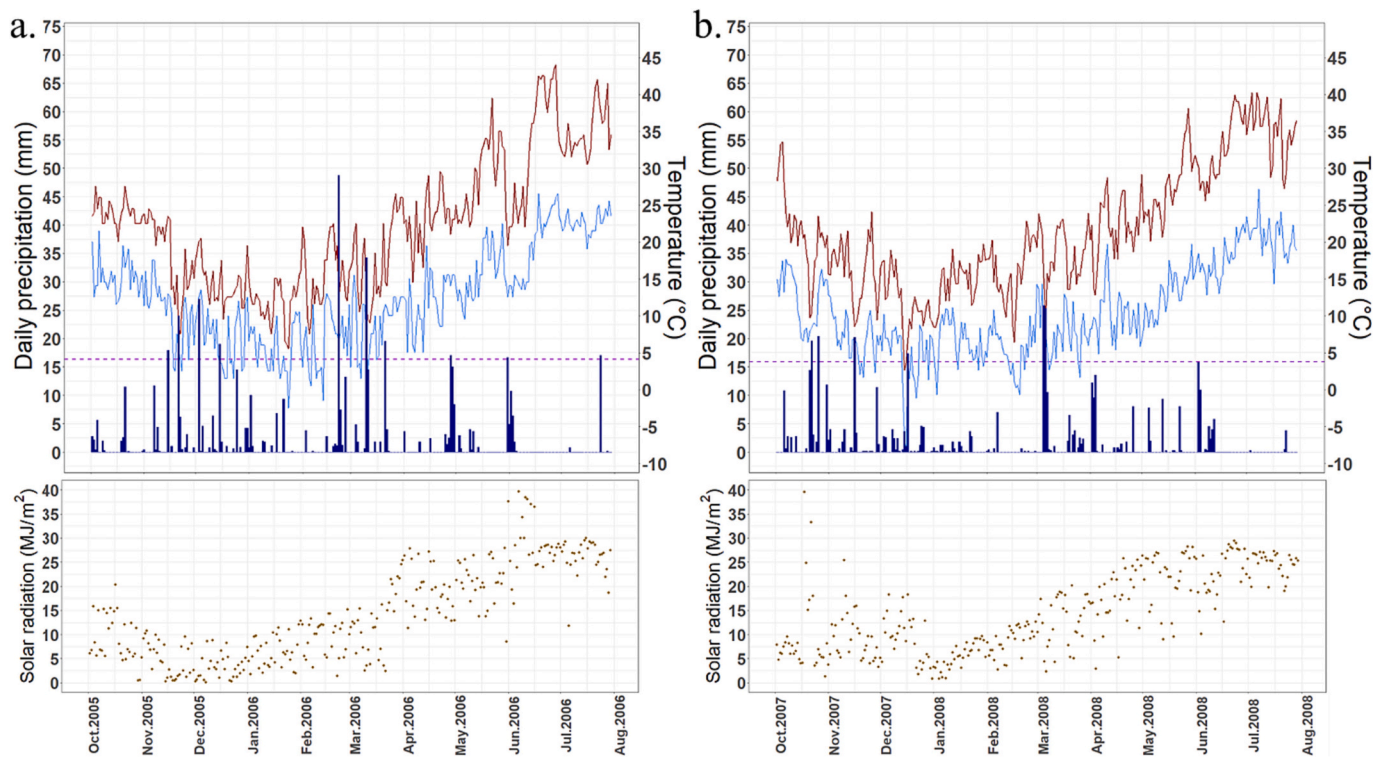

Fig. 1. Daily precipitation, air temperatures (maximum = red lines and minimum = blue lines) and solar radiation for (a.) 2005–2006 and (b.) 2007–2008 growing seasons for the experimental field. Purple dashed lines correspond to the mean temperature over the years 2005–2006 and 2007–2008. Respectively for 2005–2006 and 2007–2008 growing seasons, cumulative rainfalls were 510.4 mm and 429.2 mm, mean solar radiation was 14 MJ/m² and 14.2 MJ/m² and mean temperatures were 14.7 °C and 13.5 °C. (For interpretation of the references to colour in this figure legend, the reader is referred to the web version of this article.)

Table 1

Crop practices of the experimental field used as management information for the modeling. Adapted from Wallor et al. (2018).

Date	Crop practice
2005–2006	
30.10	Ploughing (0.40 m)
13.11	Disc-harrowing (0.15 m)
07.12	Disc-harrowing (0.15 m)
15.12	Sowing winter wheat (cv. Gargano) + fertilization with ammonium phosphate (30 kg N/ha)
20.02	Fertilization with ammonium nitrate (60 kg N/ha)
26.06	Harvest winter wheat
2007–2008	
14.12	Sowing winter wheat (cv. Gargano) + fertilization with ammonium phosphate (30 kg N/ha)
28.02	Fertilization with ammonium nitrate (60 kg N/ha)
05.07	Harvest winter wheat

A pedometrics approach was used to model soil hydraulic limit (SHL) values, i.e. air dry moisture content (AD), lower limit soil moisture at -1.5 MPa (LL15), crop lower limit (CLL), soil water (SW), drained upper limit (DUL) and soil water at saturation (SAT) at each layer from the topsoil observations (Fig. 4). In particular, SHL values at each measurement site profile were estimated from the observed topsoil measurements and known SHL shapes for Vertisol soils described in Dalglish et al. (2016) in order to initialize model parameters. The SW for each layer i was calculated from the modeled CLL and DUL of each layer using Eq.1.

$$SW_i = 0.25 \times ASW_i = 0.25 \times (DUL_i - CLL_i) \quad (1)$$

where SW_i , ASW_i , DUL_i and CLL_i are respectively the soil water, the available soil water, the drained upper limit and the crop lower limit for

the i^{th} layer.

2.3. Spatial calibration of APSIM

Calibration of soil and plant parameters was performed independently on each considered production year and evaluated on the other year as explained in section 2.4. Weather data, soil information, initial soil water, nitrogen content and agronomic management practices were used as input for the calibration. APSIM was spatialized by using a downscaling approach that mainly involved spatial calibration, by defining within-field zones using ancillary data and identify which parameters could be spatially calibrated. The high-resolution soil sensor data, EC_aV and EC_aH data, were used together for delineating within-field zones (minimum of 2 and maximum of 20) using a segmentation algorithm (Pedroso et al., 2010) with the GeoFIS R package (Guillaume and Lablée, 2022). Default settings were used with the segmentation algorithm. Both ancillary data were correlated to durum wheat yield so they could potentially explain the yield variability. Following the zone delineation, the different spatial scales which were considered for the calibration and the evaluation in this study were:

- (i) the measurement sites scale ($n = 100$);
- (ii) several within-field zones ($z \in [2;20]$) (Fig. 5);
- (iii) and the whole field (equivalent to a one zone solution), i.e. the APSIM native spatial footprint.

For scales higher than the site-scale, data were aggregated at the different zonal scales by averaging the observations located within each individual zone. For all performance assessments, the output scale was disaggregated to the measurement site-scale to evaluate the modeling performance (Fig. 6). However, some parameters were calibrated with the same value regardless of the of spatial modeling units, i.e. these parameters were fixed whatever the modeling scale. For instance, this is

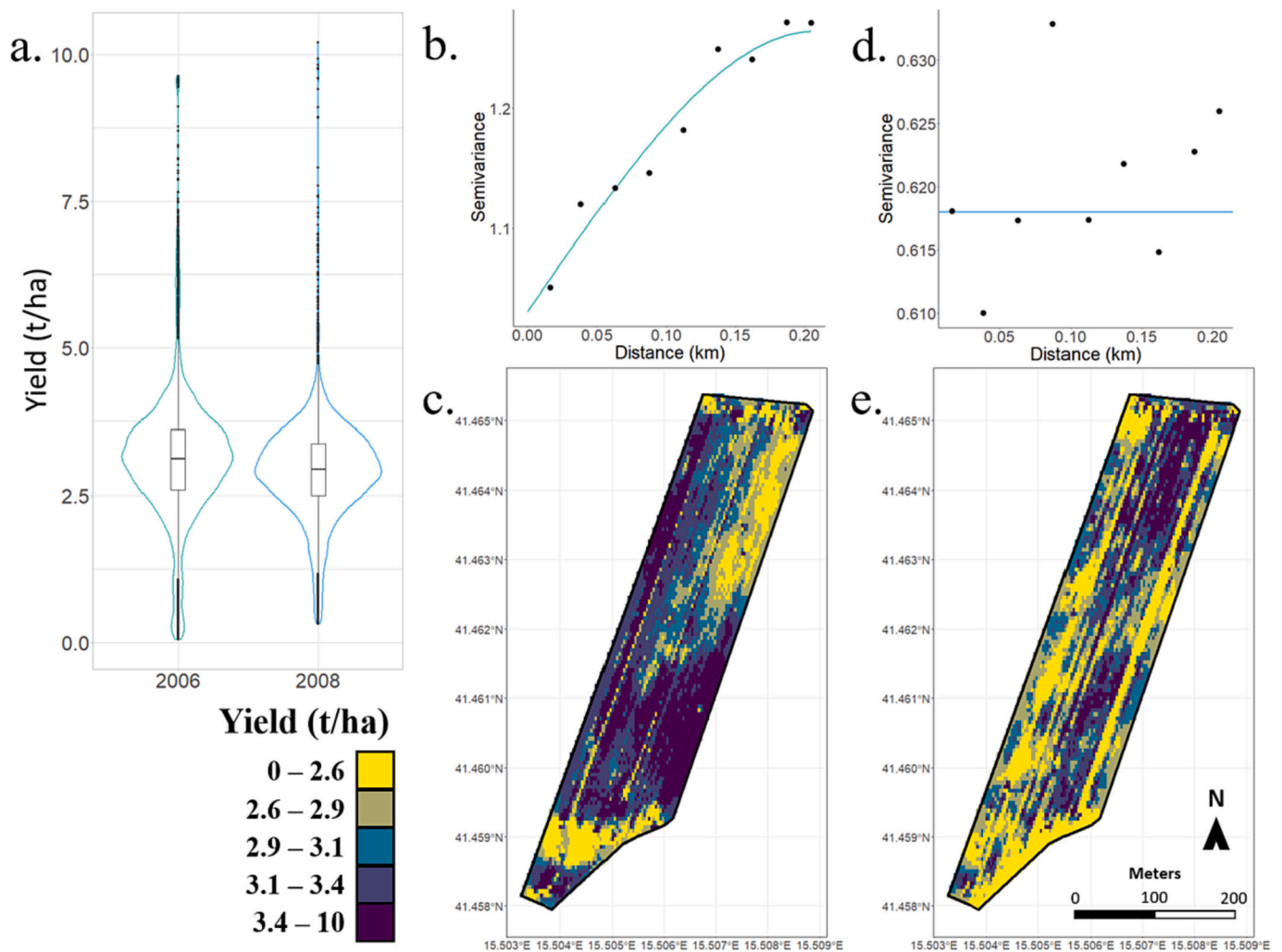

Fig. 2. Durum wheat yield characterization. (a.) Distribution of yield values recorded by yield monitor system at harvest, mean yield in 2005–2006 and 2007–2008 were respectively 3.0 t/ha and 2.8 t/ha. (b.) Experimental and theoretical variogram of durum wheat yield in 2005–2006, yield is spatially structured at within-field scale. (c.) Durum wheat yield map in 2005–2006. (d.) Experimental and theoretical variogram of durum wheat yield in 2007–2008, yield exhibits no spatial structure at the within-field scale as shown by the shape of variogram model as pure nugget effect. (e.) Durum wheat yield map in 2007–2008.

the case for the cultivar parameters (related to phenology), because it was the same sown cultivar under the same climatic conditions.

Spatial calibration was performed through several spatial and aspatial steps (Fig. 7) to adjust (1) the observed phenology stages with the modeled phenology stages, then (2) the observed soil water content with the modeled soil water content, then (3) the observed biomass with the modeled biomass and then (4) the observed yield with the modeled yield. These steps were selected to match with de Wit's concept (van Ittersum et al., 2003) of crop growth modeling, i.e. calibrating first phenology, constraints related to light, temperature and crop genetic and then stresses related to soil water content. This calibration methodology based on expertise was also applied to others studies on crop modeling particularly because it helps complex optimization which can be too difficult with lots of local optima (Seidel et al., 2018; Wallach et al., 2021). Calibration of the aspatial parameters assumed that parameters were constant over the field regardless of the number of within-field zones/sites (e.g. cultivar parameters). Calibration of spatial parameters assumed the parameter values could be different in the within-field zones or at the measurement sites (e.g. soil parameters).

First, cultivar phenology parameters were adjusted to match the observed phenology stages with the modeled phenology stages. As only one cultivar (Gargano) was sown, the phenology was assumed to be homogeneous over the field and corresponded to an aspatial calibration

(Fig. 7a.). Secondly, the soil water content was calibrated spatially by modification of the SHL values. The CLL and DUL values on the first layer (0–0.05 m) were estimated directly from the observed soil texture measurements related to the plant available water capacity. Calibration was used to determine CLL and DUL values for the other layers (2nd to 7th) and also the values of other SHLs (AD, LL15, SW, and SAT) for the whole soil profile (Fig. 7b.). This spatial calibration tended to conserve the global shape of the local soil profile (example described in Fig. 4) for each site. Thirdly, biomass was calibrated by adjusting spatial and aspatial model parameters. Aspatial calibration was related to cultivar parameters considered homogeneous over the whole field (Fig. 7c.). However, the biomass was not considered homogeneous at the within-field scale since it may depend on water and nutrient availability in the field (Mon et al., 2016). Thus, parameters not related to potential biomass but to water stress affecting its expansive growth needed to be calibrated spatially (Fig. 7d.). As a first approximation to account for biomass variability, the fraction of plant available water able to be extracted (KL) in the model was considered to be the main driver of the biomass. Before this calibration step, four classes of soil KL (A, B, C and D) were defined that were considered representative of the soil profiles with increasing extractable water from A to D (see Supplementary Fig. S.1). The KL was spatially calibrated by assigning the different soil profiles (in the case of the site-specific modeling) or a zonal mean soil

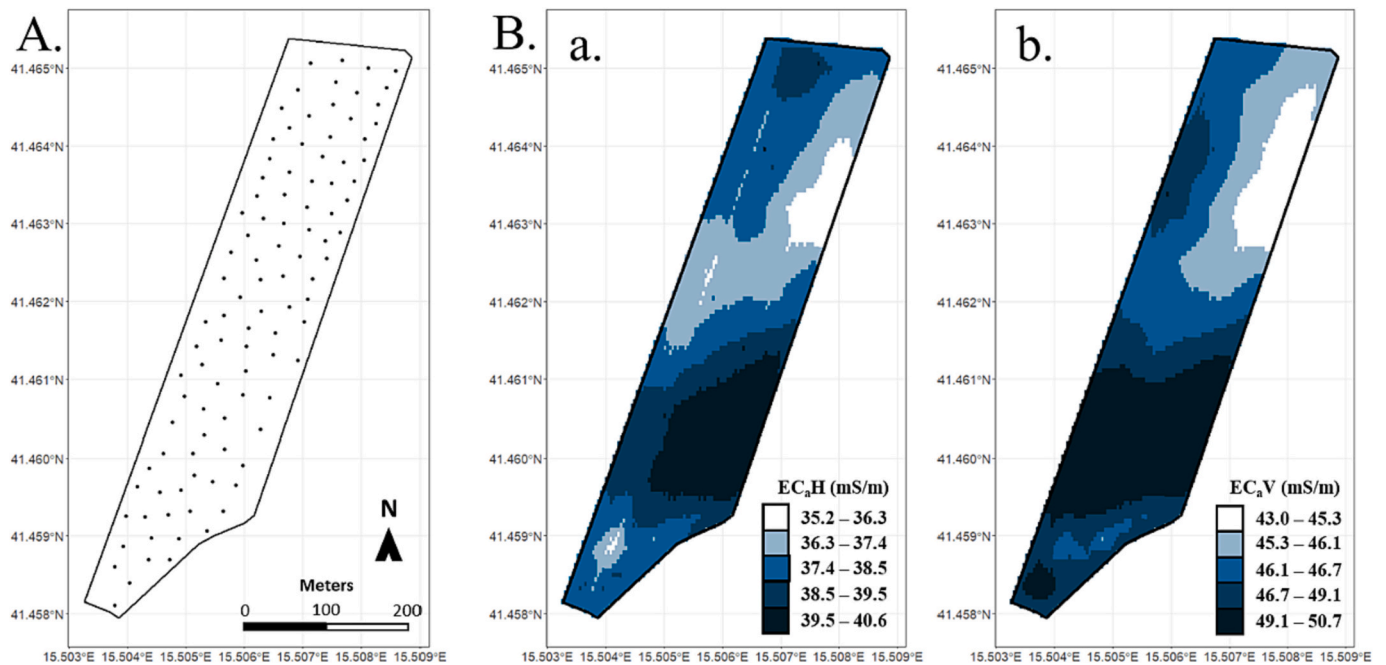

Fig. 3. Experimental field with A. Location of 100 measurement sites at within-field scale. B. Interpolated maps of (a.) apparent soil electrical conductivity in horizontal mode (EC_{aH}) and (b.) in vertical mode (EC_{aV}) using inverse distance weighting.

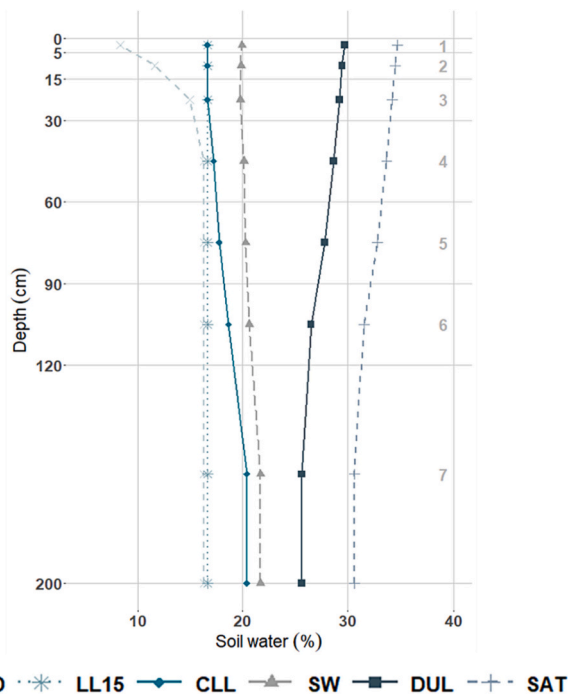

Fig. 4. Example of a general soil profile shape for soil water properties used to model durum wheat yield with APSIM for one of the considered measurement sites. Right-hand side numbers refer to the soil layer number. Lines refer to soil hydraulic limits: AD = air dry moisture content, LL15 = lower limit soil moisture at -1.5 MPa, CLL = crop lower limit, SW = soil water, DUL = drained upper limit and SAT = soil water at saturation. Each point refers to the soil hydraulic limit value for the corresponding layer in volumetric water content.

water profile to one of these four classes. Calibrating KL this way was a first approach to account for spatial soil moisture variability in the field. Finally, yield was calibrated by again adjusting the aspatial cultivar parameters in terms of grain number size (Fig. 7e.) and then, in a similar

way as to the KL calibration, three soil DUL classes (1, 2 and 3) were specified and spatially adjusted (Fig. 7f.) to correspond to different available soil water regimes (see Supplementary Fig. S.2). KL and DUL were chosen to be spatially calibrated because a previous study (Basso et al., 2009) showed that subsoil constraints (especially soil water retention properties) were the main factors impacting spatial structure in this field. All calibrated and estimated parameters needed as APSIM inputs are shown in Table 2. Note that in order to ensure a consistency of the calibrated parameters, calibration was carried by an optimization of the value of each parameter previously cited. The optimization was made as objective as possible by finding the best combination of values that resulted in the best calibration results from an expert-defined value domain range for each parameters, i.e. the optimum values were found by exhaustive search in a grid of values with physically consistent bounds. The possible domain range used for each parameter was consistent regardless of the modeling scale. This procedure aimed to be a relevant approach to following and testing the calibration method whilst maintaining logical values for the parameters that were describing the underlying biophysical processes.

For each of these calibration steps, the root mean square error of calibration (RMSE_C) (Eq. 2) was used to determine the optimal value of the target model parameter by comparing the observed and modeled parameter values.

$$RMSE_C = \sqrt{\frac{1}{n} \sum_{i=1}^n (y_i - \hat{y}_{C,i})^2} \quad (2)$$

where y_i is the observed value, $\hat{y}_{C,i}$ is the corresponding modeled value for the calibration and n is the number of observations.

2.4. Model output evaluation

To test the temporal stability of the spatial calibration, APSIM performance was tested for the different spatial scales in two distinct cases: (i) calibration on 2005–2006 data and evaluation on 2007–2008 data and, (ii) the inverse, with calibration on 2007–2008 data and evaluation on 2005–2006 data. Note that both seasons were dissimilar in weather conditions and grain yield production. The cultivar parameters were calibrated differently for both cases because having only 2 years of data

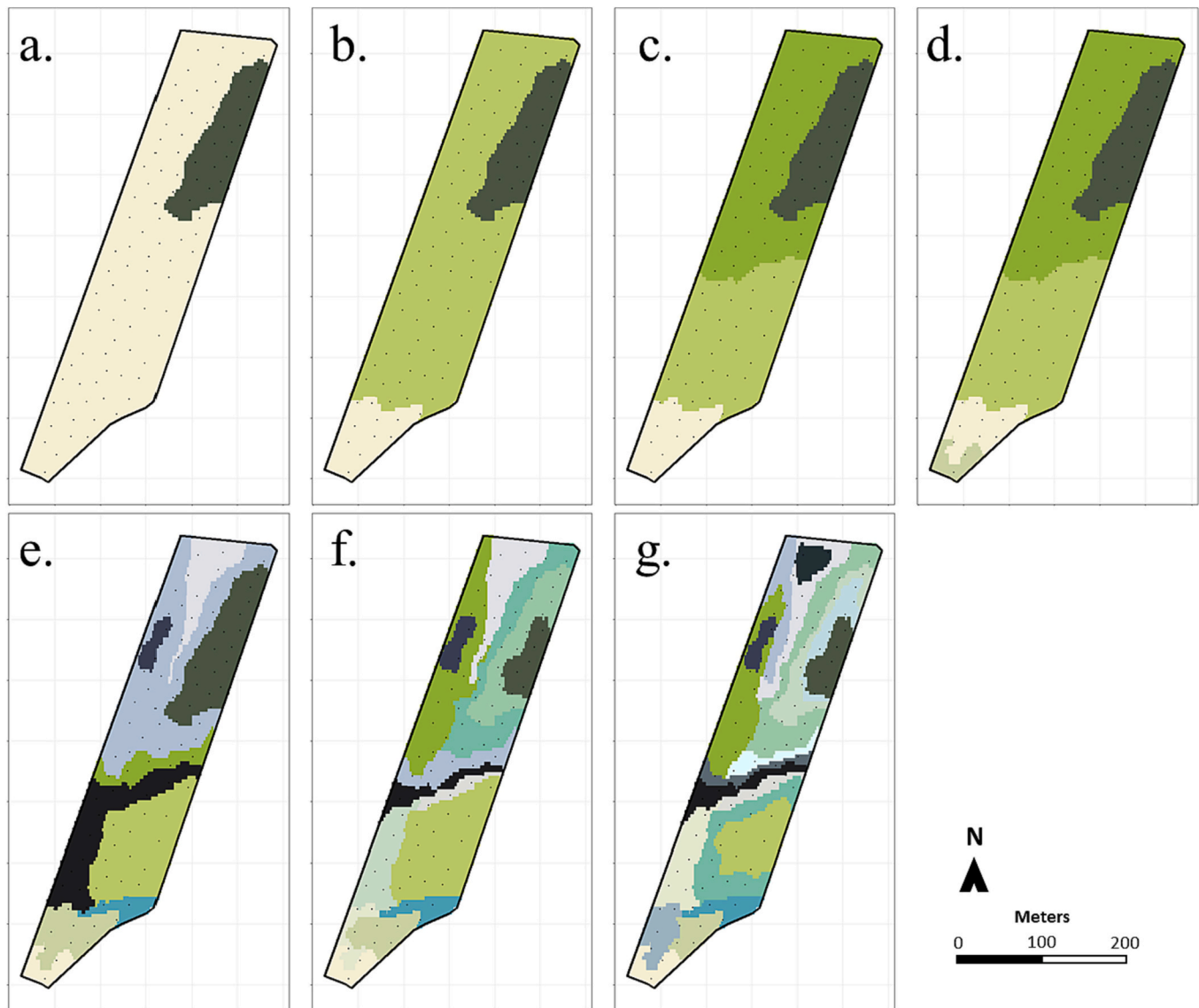

Fig. 5. Maps of different within-field zones defined using a segmentation algorithm based on soil apparent electrical conductivity data on horizontal and vertical mode together; 2-zone (a.), 3-zone (b.), 4-zone (c.), 5-zone (d.), 10-zone (e.), 15-zone (f.) and 20-zone (g.) for the experimental field. Note that the 1-zone is equivalent to the whole field scale (not shown). Points within the field indicate sampling locations for soil and crop parameters.

was not enough to estimate the general parameters of this cultivar under these climatic conditions. Thus, cultivar parameters were calibrated individually for both cases to better match the predicted yield. To evaluate APSIM performance, durum wheat biomass and yield were qualitatively evaluated from the maps and quantitatively evaluated using two metrics: root mean square error of prediction (RMSE_p) (Eq. 3) to evaluate prediction performance and spatial balance accuracy (SBA) (Eq. 4) to evaluate simulation performance accounting for spatial relevance.

$$\text{RMSE}_p = \sqrt{\frac{1}{n} \sum_{i=1}^n (y_i - \hat{y}_{E,i})^2} \quad (3)$$

where y_i is the observed value, $\hat{y}_{E,i}$ is the corresponding modeled value and n is the number of observations.

The SBA is a specific metric for spatialized crop models (Pasquel et al., 2023) calculated by assessing both aspatial and spatial pattern errors. Thus, SBA is able to identify which simulation scale is the most relevant for modeling an agronomic variable (durum wheat yield here) using a given model (APSIM) and a given downscaling process (spatial

calibration of selected model parameters).

$$\text{SBA} = \frac{1}{100} \sum_{q=1}^{100} [1 - \text{BA}(O_{t(O,M,q)}, M_{t(O,M,q)})] \quad (4)$$

where O and M are respectively the observed and modeled maps, $O_{t(O,M,q)}$ and $M_{t(O,M,q)}$ are respectively the observed and modeled maps at threshold level $t(O,M,q)$ that is defined relative to percentile q on the merging data distributions of O and M .

The closer SBA is to 0, the better the agreement between the observed data and output from the spatialized model. Note that in the spatial calibration step this metric was not used to determine the spatialized model parameters (only RMSE_C was used). However, the SBA scores for biomass and yield maps were calculated during the calibration process to provide a greater understanding on how the calibration was affecting the spatialized APSIM model outputs at different simulation spatial scales.

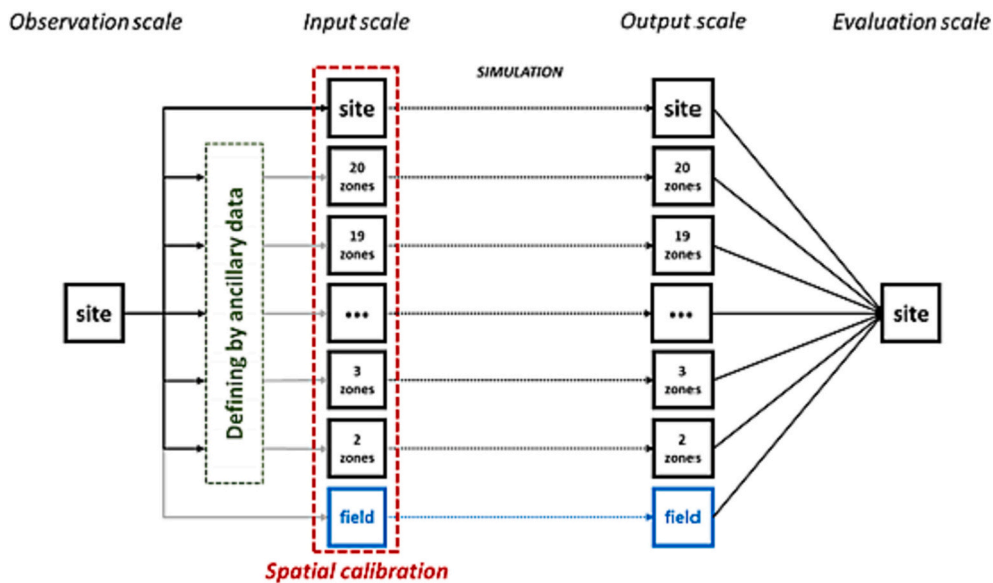

Fig. 6. Different modeling scales of durum wheat yield using APSIM from site measurement observation scale, intermediate within-field scales (2 to 20 zones) defined with ancillary data related to soil characteristics up to the whole field scale. The APSIM’s native spatial footprint is shown in blue and corresponds to the field scale. Measurement site-scale corresponds to the original observation scale. The grey arrows correspond to the upscaling process associated with aggregations of the observed data to a higher spatial scale as model input. The spatial calibration is performed at this input scale. (For interpretation of the references to colour in this figure legend, the reader is referred to the web version of this article.)

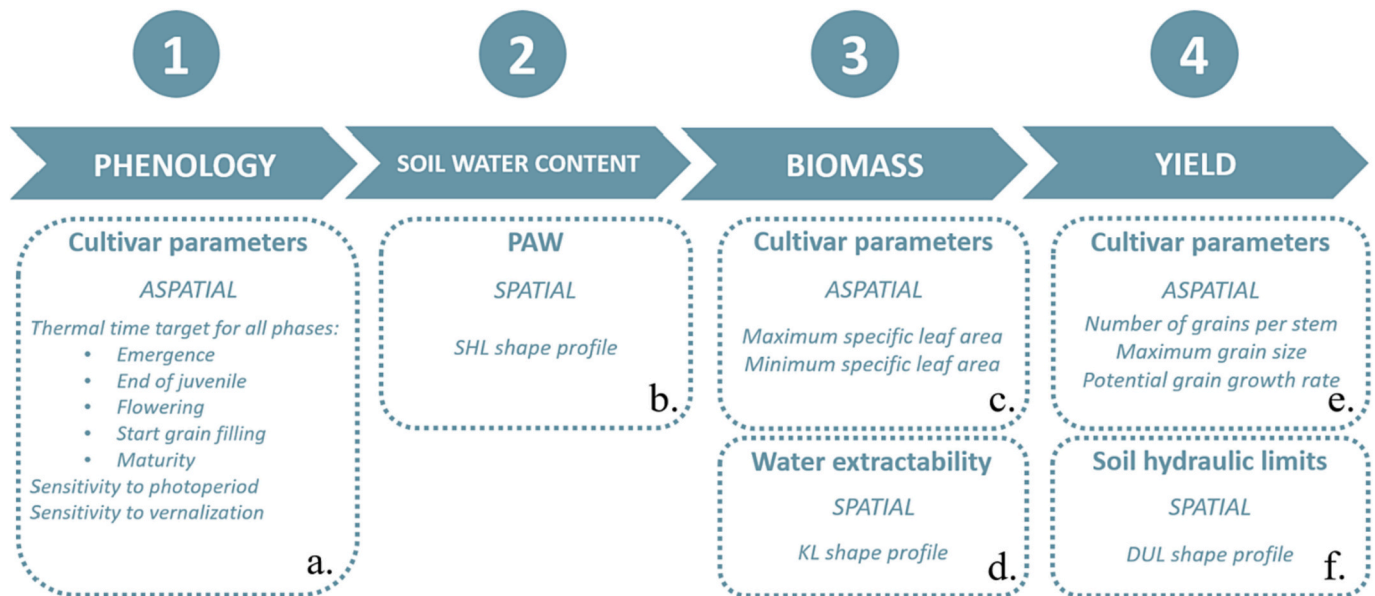

Fig. 7. Calibration steps followed for the spatial calibration of APSIM. Cultivar parameters were not spatially calibrated, whereas the other parameters were spatially calibrated. Italic parameters correspond to APSIM input parameters. SHL: soil hydraulic limits, PAW: plant available water, KL: fraction of plant available water able to be extracted, DUL: drained upper limit.

3. Results

3.1. Spatial calibration maps for the different simulation scales

Spatial calibration of the KL and DUL profiles differed with simulation scale when performed on the 2005–2006 data (Figs. 8 and 9). For the within-field spatial calibration (zonal approach), several within-field zones had the same parameter values (profiles). For the site-scale, the diversity of calibrated KL and DUL profiles was more important than for higher simulation scales (more details on KL and DUL profiles are shown in Supplementary Fig. S.1 and S.2; note that KL and DUL profiles will be

hereafter designed respectively from A to D profiles and from 1 to 3 profiles as explained in section 2.3). For the site-scale spatial calibration, the KL and DUL profiles represented the full diversity of considered profiles. However, for simulation of larger zones, this diversity was reduced, e.g. there was an absence of the KL profile D for simulation scales below 10 within-field zones (Fig. 8a to 8e) and an absence of the DUL profile 3 for simulation scales below 20 within-field zones (Fig. 9a to 9h). Spatial calibration for scales higher than the site-scale simulation tended to homogenize calibrated profiles. Moreover, the merging of different within-field zones did not necessarily lead to an intermediate profile of these different within-field zones. For example, in 2005–2006,

Table 2

Summary of calibrated and estimated parameters necessary as APSIM inputs to simulate durum wheat yield. Further details on the values of the aspatially calibrated parameters are available in Supplementary Table S.1 and S.2.

Parameters	Abbreviation	Calibration and estimation methods	Calibration
Lower limit –1.5 MPa Drained upper limit	LL15 DUL	Measured on the 1st layer Estimated from Dalgliesh et al. (2016) for other layers Implement different profiles (1, 2 and 3) to match with the yield of the calibration year (see SHL profiles), variation of DUL profile to reduce wheat available soil water	Spatial
Bulk density Air dry Saturation Crop lower limit Soil water Fraction of plant available water able to be extracted	BD AD SAT CLL SW KL	Estimated from Dalgliesh et al. (2016) based on LL15 and DUL measurement on 1st layer Eq. 1 Estimated from Dalgliesh et al. (2016) Implement different profiles (A, B, C and D) to match with the biomass of the calibration year (see KL profiles)	
Organic carbon	OC	Measured on the 1st layer Estimated from Dalgliesh et al. (2016) for other layers	
Root exploration factor Proportion of non-inert C in the microbial biomass pool Proportion of initial organic C assumed to be inert Target thermal time (cultivar parameter)	XF FBiom FInert –	Estimated from Dalgliesh et al. (2016) – – Calibrated by an exhaustive search on a discredited range	Aspatial
Leaf area growth (cultivar parameter) Seed growth (cultivar parameter)	– –	– –	

the western side of the field was mainly calibrated to DUL profile 2 with some 1 and 3 profile zones at the site scale, but calibrated to profile 1 especially for lower order zoning ([Fig. 9](#)).

Spatial calibration of KL and DUL profiles performed with the 2007–2008 data showed the same trends as the 2005–2006 data described above. These results are given in Supplementary Fig. S.3 and S.4. Maps of the other spatial soil inputs to APSIM, OC and difference between CLL and DUL, are also shown in Supplementary Fig. S.5. Only the topsoil maps (directly observed data) are shown as the values in the subsoil layers were estimated from these topsoil data (Supplementary Fig. S.5).

Minimization of $RMSE_C$ for the spatial calibration of KL and DUL profiles are shown in Supplementary Fig. S.6, S.7, S.8 and S.9. The values for parameters aspatially calibrated are available in Supplementary Table S.1 and S.2.

3.2. Calibration performances using SBA

The SBA scores ([Table 3](#)) were also calculated during the model calibration process to see if the best performing modeling scale could be identified before (and was consistent with) the evaluation step. SBA scores were computed for the spatial calibration steps 3 and 4, i.e. to

assess the coherence between observed and modeled biomass and yield data, respectively. Compared with the SBA scores computed for the model evaluation ([section 3.3](#)), there was less variation in the biomass and yield SBA scores during the calibration step ([Table 3](#)). For the yield SBA scores for calibration, the variations were similar to the yield prediction SBA scores, in particular there was a relative stability in the SBA scores for simulation scales from 4-zone to site scale modeling. The exception to this was the calibrated site-specific yield SBA score in 2007–2008 data that was considerably lower than the 20-zone SBA score. Thus, SBA scores on calibration steps did not match with SBA scores computed for the evaluation step ([section 3.3](#)) on durum wheat yield.

3.3. Spatialized APSIM performance to simulate durum wheat yield

When the model was calibrated on the 2005–2006 data and applied to the 2007–2008 data, there was a difference of 20% in the mean aspatial error between the best performed modeling scale (field scale) and the worst performed modeling scale (site-scale), with respectively a $RMSE_p$ of 0.94 t/ha and 1.17 t/ha ([Table 4](#)). There was no strong visual linear 1:1 relationship between the observed and modeled zonal or site-specific yield (Supplementary Fig. S.10). In most cases, the zone with the highest modeled yield tended towards an overestimation of yield. In this situation, it is unsurprising that the yield prediction at field-scale modeling generated the lowest $RMSE_p$. When the data sets were inverted (calibration on 2007–2008, prediction on 2005–2006), there was a difference of 9% of aspatial error between the best performed modeling scale (2-zone scale) and the worst performed modeling scale (site-scale), with respectively 1.32 t/ha and 1.45 t/ha ([Table 4](#)). Again, there was no clear linear 1:1 relationship between the observed and modeled zonal or site-specific yield (Supplementary Fig. S.11). However, modeled yields at within-field scales had less overestimation with this combination and the 2-zone scale was identified as the best performing scale.

Regarding the spatial error between the observed and modeled data, it was difficult to identify which modeling scale had the best performance by only using the 1:1 plots (Supplementary Fig. S.10 and S.11) and the simulated yield maps ([Figs. 10 and 11](#)). Indeed, concerning yield maps, it was difficult to identify a real spatial pattern among the site-scale observed data ([Figs. 10 and 11](#)), whereas modeling at within-field scales exhibited clear delineated zones that did not clearly match visually with the observed data ([Figs. 10 and 11](#)). None of the within-field scale for both years of calibration/modeling seemed to be the more relevant.

The SBA scores ([Table 5](#)) on the predicted 2005–2006 and 2007–2008 yields respectively showed that field scale modeling and 5-zone modeling were identified as the best performing, with SBA scores of 0.15 and 0.17 respectively. Compared with results shown in [Figs. 10 and 11](#) and Supplementary Fig. S.10 and S.11, the SBA scores showed additional information of the model performance that could not be identified from the $RMSE_p$ values, the observed vs modeled plots or the visual yield map comparisons. With only a $RMSE_p$ interpretation, evaluation on the predicted 2005–2006 yield identified the 2-zone modeling scale as the best performing scale. In contrast, the SBA scores identified the 5-zone modeling as the best performed ([Table 5](#) and Supplementary Fig. S.11). The SBA scores gave a relevant spatial evaluation of the APSIM performance as defined for spatialized crop models with estimation of aspatial and spatial error ([Pasquel et al., 2023](#)). There was a stabilization of SBA scores between the 10-zone to site-scale modeling. The biggest deviations in the SBA scores tended to be located between the field-scale and 5-zone scale modeling in both years, although the SBA scores and their evolution with the number of zones was very different depending on the calibration/evaluation year. It is clear that a calibration in 2007–2008 resulted in lower SBA scores.

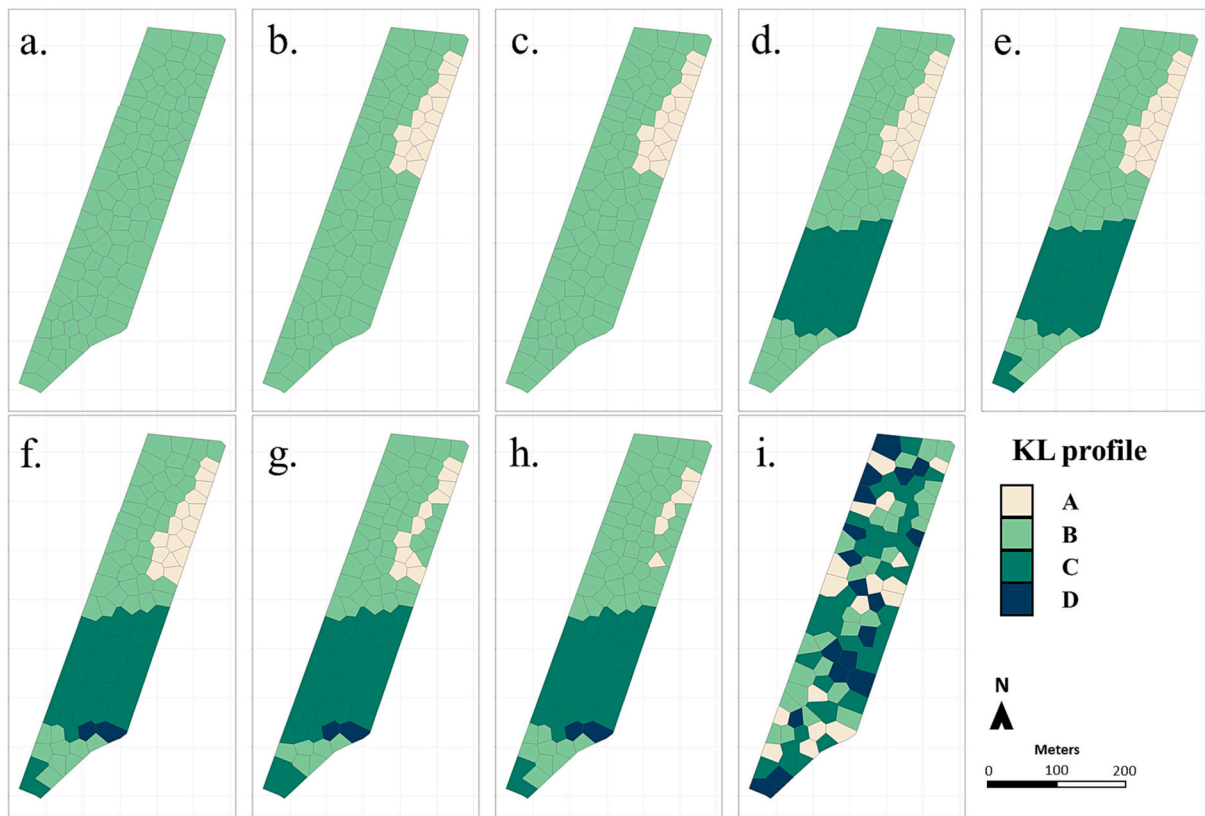

Fig. 8. Maps of spatially calibrated fraction of plant available water able to be extracted (KL) profiles for each simulation scale on 2005–2006 data: (a.) field scale, (b.) 2-zone scale, (c.) 3-zone scale, (d.) 4-zone scale, (e.) 5-zone scale, (f.) 10-zone scale, (g.) 15-zone scale, (h.) 20-zone scale and (i.) site-scale. Voronoi tessellation was used to convert each data point into polygons. Note that A and D KL profiles are respectively the soil profiles with the least and the most extractable water (more details on KL profiles are shown in Supplementary Fig. S.1).

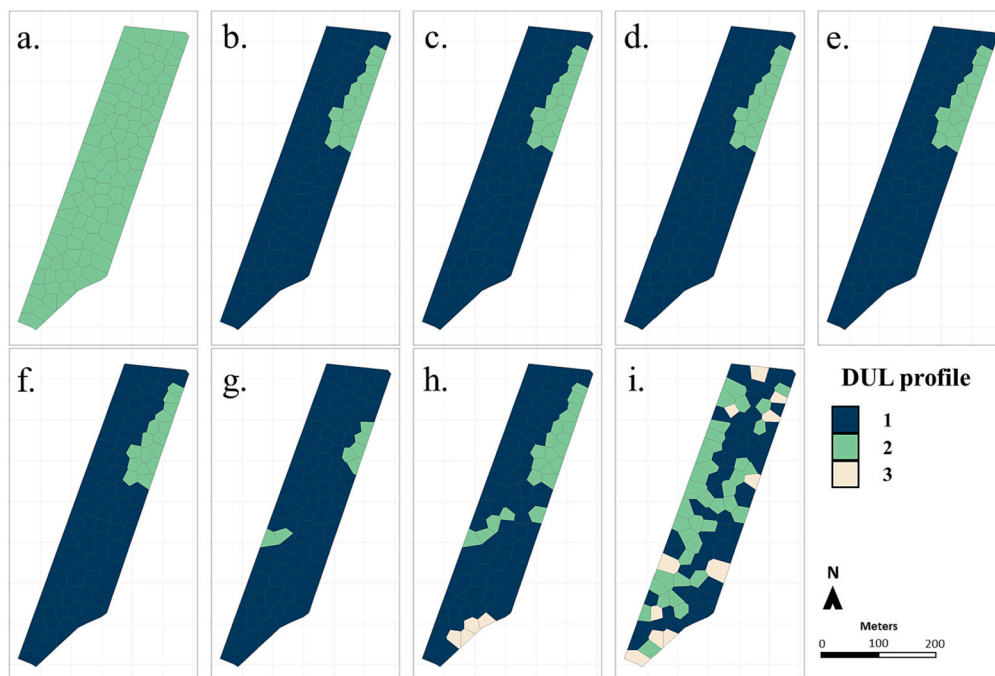

Fig. 9. Maps of spatially calibrated drained upper limit (DUL) profiles for each simulation scale on 2005–2006 data: (a.) field scale, (b.) 2-zone scale, (c.) 3-zone scale, (d.) 4-zone scale, (e.) 5-zone scale, (f.) 10-zone scale, (g.) 15-zone scale, (h.) 20-zone scale and (i.) site-scale. Note that 1 and 3 DUL profiles are respectively the soil profiles with the most and the least available soil water (more details on DUL profiles are shown in Supplementary Fig. S.2).

Table 3

Spatial balanced accuracy (SBA) to assess calibration of APSIM spatialized version for modeling durum wheat biomass and yield at the field level and at different within-field spatial scales for the two different years.

Year	Variable	Scale (zones)								
		Field	2	3	4	5	10	15	20	Site
2005–2006	Biomass	0.13	0.19	0.19	0.18	0.18	0.18	0.19	0.21	0.16
	Yield	0.14	0.28	0.26	0.27	0.24	0.23	0.24	0.24	0.23
2007–2008	Biomass	0.16	0.23	0.24	0.23	0.22	0.20	0.19	0.21	0.15
	Yield	0.15	0.26	0.23	0.27	0.27	0.27	0.25	0.26	0.19

Table 4

Root mean square error of prediction (RMSE_p) to assess the ability of the spatialized APSIM version to model durum wheat yield at field level and different within-field spatial scales for two different years of calibration and evaluation. Values indicated are in t/ha.

Calibration year	Evaluation year	Scale (zones)								
		Field	2	3	4	5	10	15	20	Site
2005–2006	2007–2008	0.94	1.04	1.02	1.13	1.13	1.09	1.04	1.04	1.17
2007–2008	2005–2006	1.44	1.32	1.45	1.42	1.42	1.40	1.41	1.38	1.45

4. Discussion

4.1. Different modeling performance depending on the calibration/prediction year

Depending on the years used for calibration and prediction, the results showed different spatialized APSIM performances for yield prediction at the within-field scale. It is hypothesized that this was affected by the differences in spatial structure of the yield data along with difference in rainfall patterns, even though the mean and numerical distribution of the yield data were similar. The 2005–2006 yield data was spatially structured while the 2007–2008 yield data was not. When the spatially structured 2005–2006 yield data was used for the spatial calibration of some model parameters and then applied to the poorly spatially structured 2007–2008 yield data, the field scale was identified as the most relevant modeling scale. The lower level of spatial structure (and patterning) in the 2007–2008 yield data suited a mean yield response that fits to the native spatial footprint. In effect, each part of the field could be calibrated with the same values for the APSIM input parameters, i.e. the whole field has the same modeled yield value (even if yield actually varied over the field). Therefore, under these conditions, the SBA score identified field-scale modeling as the best performing scale even if there were some within-field yield variations ignored by this modeling scale. Field-scale modeling allowed the best trade-off for a better modeling of the yield based on aspatial and spatial coherence with the observed data. In contrast, when the spatial calibration was done on the poorly spatially structured 2007–2008 yield data, and evaluated on the spatially structured 2005–2006 yield data, the 5-zone scale was identified as the most relevant modeling scale according to the SBA score. In this situation, the spatial calibration was carried out on within-field zones segmented from spatially structured ancillary data that were correlated with durum wheat yield. Even with a relatively poor spatial structure in the 2007–2008 yield data, this spatial calibration succeeded in defining a distinction between the zone/site-specific APSIM input parameter values to reproduce the spatial patterns in the observed data. Thus, spatial calibration was relevant in this case. However, the relevance of the spatial calibration was based on the data from the end of the season that does raise questions regarding the management decisions that should have been made during the season. This is an important question to make this method applicable in a real world situation. However, in the present study the aim was to understand how APSIM is working at the within-field scale, i.e. to understand if it is relevant to use APSIM at finer spatial scales. Based on these results, considerations on how this method is applicable for farmers to advise them in differentially adapting their management for in-season production are better known.

The spatial calibration aims to constrain the calibration process to ensure the reproduction of the spatial pattern of the agronomic variable. However, more work is still necessary to make a relevant spatial calibration in a truly operational context, i.e. there needs to be a trade-off between the calibration zones and the management zones, which reflect the real within-field management practices. The optimal scale of spatial calibration for the model will not necessarily align with the optimal scale of management possible by the grower. Other complementary methods could be applied to the output maps to take into account the operational constraint linked to used machines for instance (Leroux and Tisseyre, 2018). However, the aim of this study was to investigate the modeling of the durum wheat yield at the within-field scale (i.e. theoretical objective) and evaluation was made regarding this objective. Modeling related to an operational context was considered here as an perspective to this work, the first step was to investigate if a use of existing crop models was relevant at within-field scale.

There was not a lot of variation among the SBA scores, with spatial calibration on the 2007–2008 data being similar between the 3-zone scale and site-scale even if the 5-zone scale modeling was identified as the best performing scale. Given these similarities, consideration could also be given to the principle of parsimony and the need to have zones and decisions that can be enacted from an agronomic perspective. Calibrating APSIM at 3 within-field zones is less time consuming and likely more relevant for management (avoids calibration on outliers and conserves spatial pattern consistency) compared to finer resolution calibration (site-scale). However, it could also ‘miss’ punctual specific patterns if not representative of the within-field segmentation.

The spatial structures and the resulting spatial patterns of the durum wheat yield were not the same between the two years because of varying precipitation and temperature profiles between years (Fig. 1). Weather conditions heavily affect rain-fed grain yield determination, especially rainfall amount and distribution over the crop season (Buttafuoco et al., 2017). Previous studies have attributed spatial variation of yield components mainly to different levels of available soil water between production years (Diacono et al., 2012; Guastaferro et al., 2010) and on this same field, Basso et al. (2012) showed that growing season rainfall and fallow rainfall were correlated with grain yield over a five year period as a result of the complex dynamic interactions between spatial static properties (e.g. soil texture) and dynamic properties (e.g. soil water content). In this study, soil information (EC_a) was used to determine management (modeling) zones that were constant for both years. Annual modeling will be influenced by how well these soil-based zones reflect production potential in a given year. The differences in the calibration/prediction outcomes by inverting the role of the two years is indicative of this limitation. Thus, while spatial calibration has shown

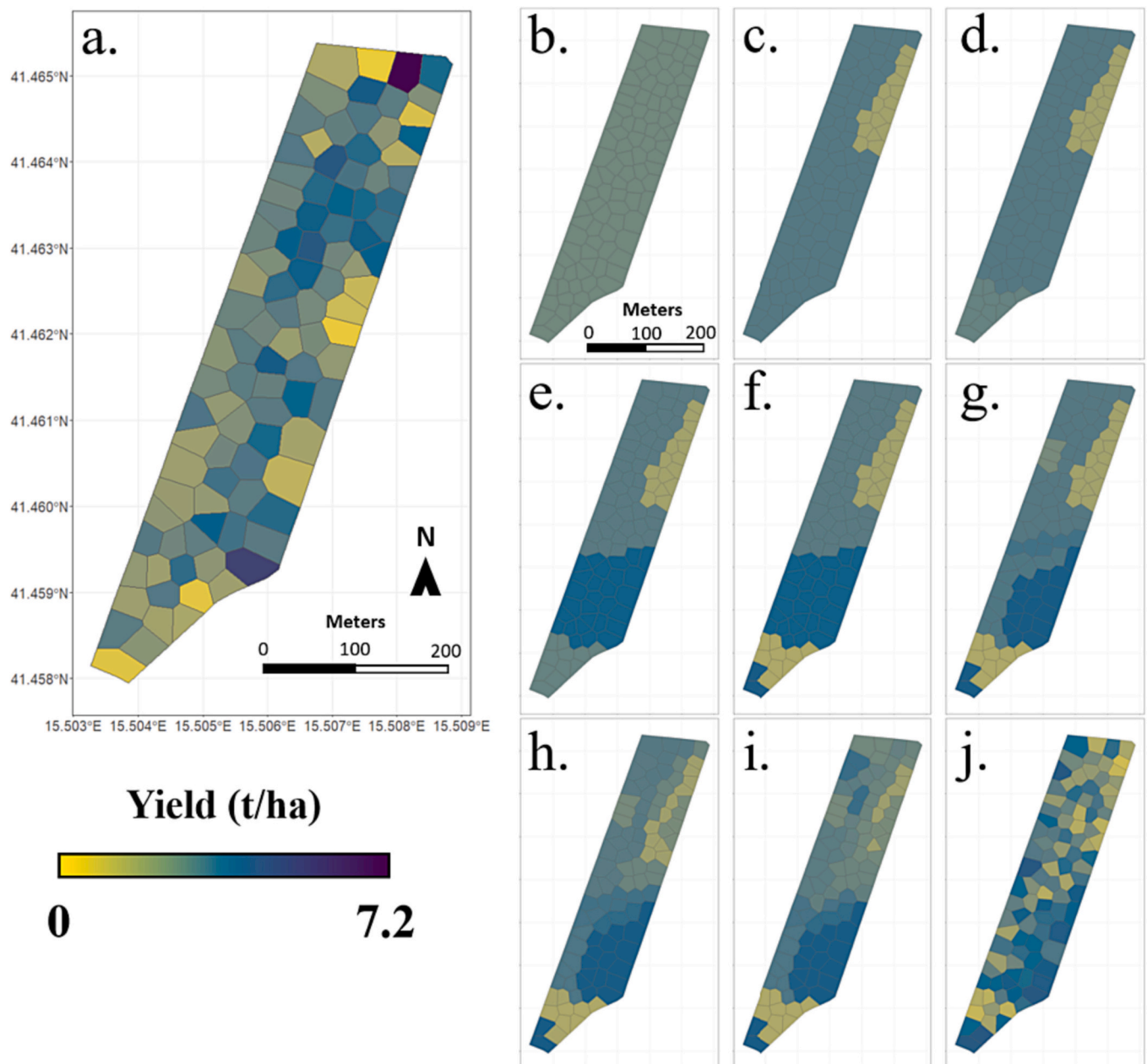

Fig. 10. Spatial patterns of durum wheat yield for (a.) observed data from 2007 to 2008 and modeled data from APSIM calibrated on 2005–2006 data for different modeling scales: (b.) field scale, (c.) 2-zone scale, (d.) 3-zone scale, (e.) 4-zone scale, (f.) 5-zone scale, (g.) 10-zone scale, (h.) 15-zone scale, (i.) 20-zone scale and (j.) site-scale.

some benefit in this study, research is still needed to better understand how ancillary data, especially soil data, can be used to generate seasonal-specific zoning for modeling, i.e. the local climate (predicted and/or observed weather conditions) should influence how downscaling methods are applied to account for known or expected local soil-plant-environment interactions.

The choice of calibration and evaluation data had a significant impact on the spatialized APSIM outputs. Thus, regarding the preliminary results of this study and the choice of static soil zones for downscaling, it was more relevant to perform spatial calibration when the target agronomic variable exhibited good spatial structures/patterns. This was expected as calibrating a model with (yield) data that is atypical of the expected response or exhibits a large amount of stochastic variation is not expected to be effective. This result could be generalized to other large and complex crop models.

In other words, the main interests in the spatial calibration are twofold. First, using the spatial calibration approach as a spatialization process allows to constrain the spatial pattern of the agronomic variable, allowing to maintain a spatial consistency in the within-field modeling. Second, the spatial calibration is able to manage a trade-off between the accuracy of prediction at changing scales against the ‘noise’ in the available input data at different spatial resolutions. A crop model calibrated individually for each modeling unit (i.e. at the site-scale) may have a significant stochastic error through the calibration process.

4.2. Sources of uncertainty linked with parametrization

The aim of this study was to investigate if using complex spatialized crop models at the within-field scale was relevant, i.e. if the uncertainty in the modeling process was acceptable to support agronomic decision-

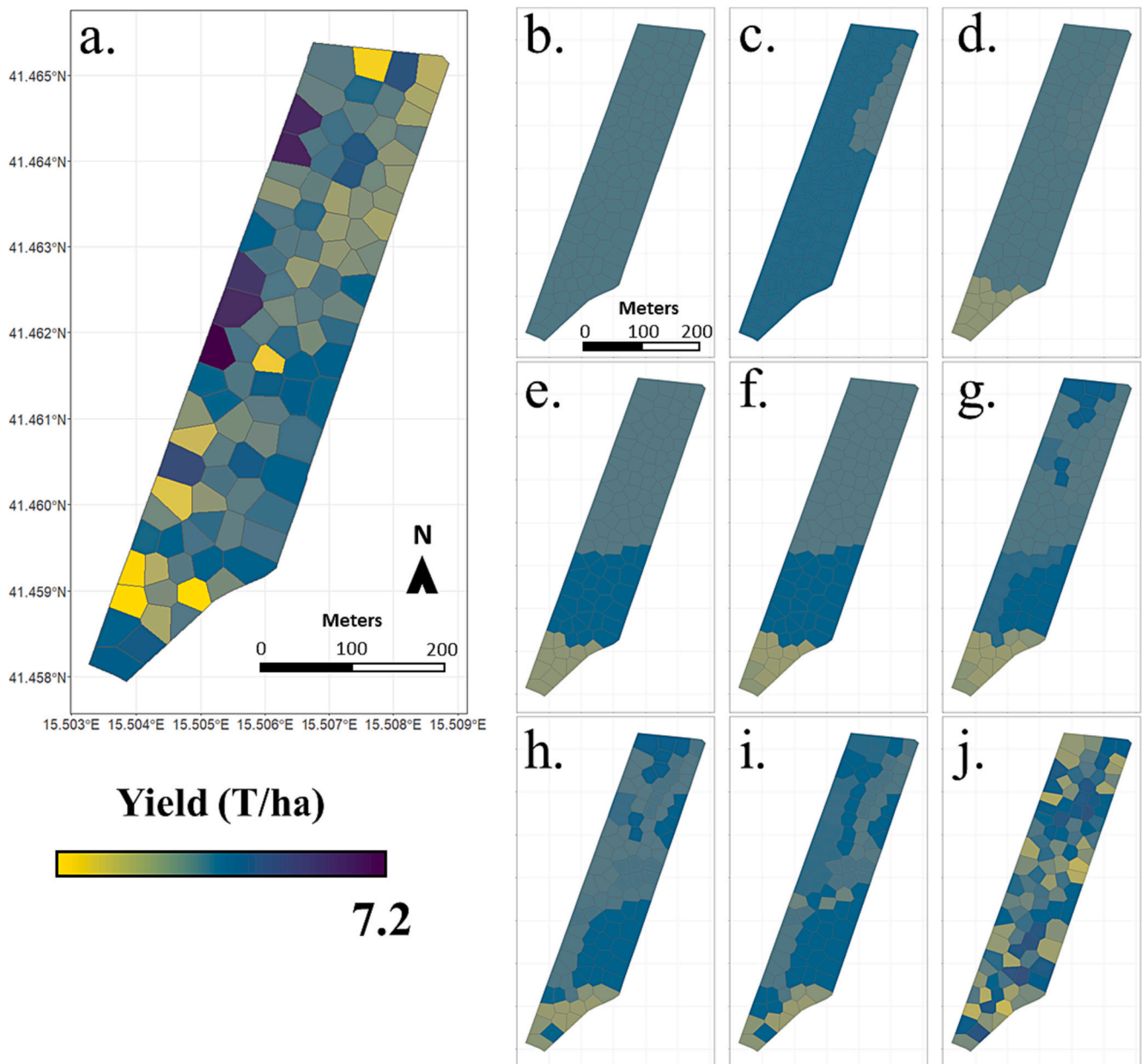

Fig. 11. Spatial patterns of durum wheat yield for (a.) observed data from 2005 to 2006 and modeled data from APSIM calibrated on 2007–2008 data for different modeling scales: (b.) field scale, (c.) 2-zone scale, (d.) 3-zone scale, (e.) 4-zone scale, (f.) 5-zone scale, (g.) 10-zone scale, (h.) 15-zone scale, (i.) 20-zone scale and (j.) site-scale.

Table 5

Spatial balanced accuracy (SBA) scores to assess the ability of the spatialized APSIM version to simulate durum wheat yield at field scale and at different within-field spatial scales for two different years of calibration and evaluation.

Calibration year	Evaluation year	Scale (zones)									
		Field	2	3	4	5	10	15	20	Site	
2005–2006	2007–2008	0.15	0.33	0.30	0.32	0.30	0.30	0.29	0.29	0.31	
2007–2008	2005–2006	0.19	0.25	0.18	0.18	0.17	0.19	0.19	0.19	0.18	

making. With the SBA score, the most relevant spatial scale for modeling could be identified for each combination of calibration/prediction years. However, there was a huge source of uncertainty using the spatialized APSIM model, especially with the assumptions made for input parameterization. APSIM is a complex crop model requiring several input parameters to work correctly to reproduce the biophysical processes implemented. Within-field downscaled modeling with spatial

calibration involves an increase in input parameterization, which may not be useful to enhance model performances (Adam et al., 2011; Soltani and Sinclair, 2015; Zhen et al., 2023). Moreover, uncertainties in the downscaled crop model use could mostly be attributed to input data and to the downscaling methods used (Porwollik et al., 2017). Even with a fairly comprehensive data set, many parameters, especially parameters related to soil characterization, needed to be estimated and were not

directly measured (e.g. SHL). Furthermore, as the resolution of the spatialization increased (from the whole field to site-specific), the available data also decreased for a given spatial area of prediction, which may introduce higher stochastic variance effects in the model calibration and evaluation. Therefore, higher input parameterization may explain why more uncertainties have been observed.

Cultivar parameters, especially growth parameters, are important parameters for crop models because they drive yield production, but they are also heavily influenced by punctual changes in water and nutrients (Archontoulis et al., 2014; Rötter et al., 2012). For this study, cultivar parameters were considered homogeneous. The assumption of homogeneity for the weather data, especially precipitation, is highly questionable. Precipitation can be variable over even small areas (Krajewski et al., 2003), altering site-specific plant available water and even small changes in slope can impact subsoil water movement and accumulation (Subedi and Fullen, 2009). Although considered flat, there was a 10 m drop in altitude in the field and a trend to higher soil water content in the southern tip has already been noted (Basso et al., 2009). Directly accounting for these variations will improve the soil water representation, soil-cultivar interactions and the APSIM calibration (Hao et al., 2021; Huth et al., 2012). For this study, soil parameters were considered the key spatial parameters to calibrate APSIM, because these parameters are known to be the main local drivers of durum wheat yield. To achieve this, many subsoil parameters were estimated from topsoil information to have a modeled soil profile up to 2 m depth. This introduced uncertainties from the pedotransfer models. Crop models are known to operate more effectively when all required input parameters are measured (Cammarano et al., 2021), thus measuring the needed input soil properties for each soil layer would clearly improve the spatial APSIM calibration. However, in commercial production systems, these subsoil data are difficult to obtain due to cost and time constraints, and pedometric approaches for subsoil information are likely to commonly used in the future to generate these data when needed. Therefore, further improvements in subsoil pedotransfer functions is an obvious starting point for improving crop model spatialization.

Spatial calibration for steps 3 and 4 was made through KL and DUL profile assignments, rather than detailed soil water observations. Again, an accurate calibration of the KL and DUL values for each soil layer at each measurement site was time and cost prohibitive, even for this research study. Profile assignment was considered here to be a good trade-off between computation time and improving modeling crop model performance. A limitation to this approach is that the assigning of a profile does not necessarily assigned the optimum value to minimize the calibration error.

4.3. Calibration performance using the SBA score

The calibration error of each simulation scale using the SBA scores (Table 3) would be interpreted differently compared to the SBA scores for evaluation (Table 5). If the relevance of the simulation scale was only based on the calibration error, then field-scale simulation (native footprint) would have been selected for both scenarios and both target variables (biomass and yield) (Table 3). In terms of practical use, these results suggest that SBA scores are highly dependent of the spatial structure/pattern of the considered agronomic variable and SBA score interpretation should be interpreted carefully. Given this is the first attempt to use the SBA to assess spatial calibration of a complex crop model, no strong conclusions can be drawn from the identification of the native footprint as the preferred modeling scale during calibration; however, this is an area where further study is needed. Metrics to best calibrate the model are as important as prediction metrics.

4.4. Within-field segmentation dependency and uncertainties

Results of this study were very dependent on the zoning performed, i.e. the ancillary data and segmentation algorithm. Ancillary data that

measures soil EC_a were chosen to delineate zones because these data are known to be related to soil texture, which in turn is temporally stable and indirectly related to soil moisture holding capacity. The assumption in this pedoclimatic region, and this particular production system, was that soil water is the dominant driver of yield. Nawar et al. (2017) highlighted that using EC_a by itself could be insufficient to quantify the spatial variability in production at the within-field scale and suggested coupling soil spatial properties with data related to crop productivity to have more reliable zones. However, this was not feasible in this study as the available yield and biomass data were part of the calibration/prediction data set and could not be considered as independent data for zone delineation. Within-field zone segmentation was also assumed to be temporally stable in this study because the segmentation was based on temporally stable soil properties. If data related to crop productivity is involved in zone delineation, it may give stable and unstable zoning overtime (multiple years). This is especially true in systems subject to very variable weather conditions. Indeed, data from multiple years will be needed for a reliable spatial calibration using crop productivity data, especially with rain-fed crops. Ideally, some historical data, such as production from previous years with similar evolving seasonal weather, and/or near real-time production data, such as within-season remote sensing images, could help to adapt zoning during the production year and delineate more relevant zones for in-season crop model simulations (Maestrini and Basso, 2018).

The strength of the spatial structure/pattern of the agronomic variable of interest was identified in this study as a driver of the success of a spatialized downscaling approach. Similarly, the strength and spatial structure/patterning of the ancillary data used in zone delineation, as well as the strength of its correlation with the modeled agronomic variable of interest, will affect the quality of the spatialized model outputs. For example, in this study, soil zones that had the highest predicted yield tended to be overestimating yield. The reason for this was unclear, but it is clear that the model was not accounting for some effect associated with production loss in these zones. In an extreme example, zoning with uncorrelated, poorly structured ancillary data will not generate sensible and relevant solutions beyond chance. As with any other application of zoning in PA, issues in the number and spatial distribution of measured sites and on the zoning methods applied should be carefully tackled (Xu et al., 2020). In studies concerning the use of crop models on a large scale, e.g. regional scale, when downscaling processes are necessary to match input scale models, correction methods are often applied (Ji et al., 2018). This kind of correction for downscaling processes at within-field scale using crop models is still rarely applied. Another limitation of current crop models is that they seldom consider lateral water movement that can greatly affect water stress as experienced by the crop, and this could explain uncertainties in the APSIM spatial calibration in this study. Huth et al. (2012) for APSIM, and Xiang et al. (2020) and Shelia et al. (2018) for DSSAT have respectively improved these crop models to account for better water movements within the soil. These improvement modules could be used in further investigations when using, for instance, APSIM at within-field scale to improve spatial calibration and spatialized model performances.

5. Conclusions

Results showed that using APSIM at a within-field scale generated more relevant yield predictions than simulating yield at the field-scale when the target variable (durum wheat yield) was spatially structured in the predicted year. Spatial calibration of selected key model parameters allowed APSIM to approximate the spatial pattern of the durum wheat yield. When the target yield was more randomly distributed, APSIM's native spatial footprint, i.e. field-scale, was identified as the most relevant. The spatial calibration of complex crop models, such as APSIM, requires many inputs and assumptions of parameters values that could lead to uncertainties in the simulations. Finer spatial calibration has a need for more observed and sensed data to be collected to drive the

calibration/evaluation process, which could be limiting in commercial situations. The delineation of within-field zones was identified as an area which could also be improved to improve the spatial model calibration. Delineation should take into account various ancillary data types, including crop parameters, such as biomass or yield maps, over multiple, climatically varying seasons so that ancillary data choices can be better targeted to predicted in-season conditions. However, when production variables exhibit a strong spatial patterning, the use of a spatial calibration approach to spatialize crop models shows promise for within-field simulation at a scale that can support decision support tools to optimize their efficiency and their field management at within-field scale. Further work is certainly needed to validate these preliminary findings in other systems and other pedoclimatic regions.

Declaration of Competing Interest

The authors declare that they have no known competing financial interests or personal relationships that could have appeared to influence the work reported in this paper.

Data availability

Data will be made available on request.

Acknowledgements

This work was supported by the French National Research Agency under the Investments for the Future Program, referred as ANR-16-CONV-0004.

Appendix A. Supplementary data

Supplementary data to this article can be found online at <https://doi.org/10.1016/j.agry.2023.103773>.

References

- Abrahamsen, P., Hansen, S., 2000. Daisy: an open soil-crop-atmosphere system model. *Environ. Model Softw.* 15, 313–330. [https://doi.org/10.1016/S1364-8152\(00\)00003-7](https://doi.org/10.1016/S1364-8152(00)00003-7).
- Adam, M., Van Bussel, L.G.J., Leffelaar, P.A., Van Keulen, H., Ewert, F., 2011. Effects of modelling detail on simulated potential crop yields under a wide range of climatic conditions. *Ecol. Model.* 222, 131–143. <https://doi.org/10.1016/j.ecolmodel.2010.09.001>.
- Archontoulis, S.V., Miguez, F.E., Moore, K.J., 2014. A methodology and an optimization tool to calibrate phenology of short-day species included in the APSIM PLANT model: application to soybean. *Environ. Model Softw.* 62, 465–477. <https://doi.org/10.1016/j.envsoft.2014.04.009>.
- Asseng, S., Martre, P., Maiorano, A., Rötter, R.P., O'Leary, G.J., Fitzgerald, G.J., Girousse, C., Motzo, R., Giunta, F., Babar, M.A., Reynolds, M.P., Kheir, A.M.S., Thorburn, P.J., Waha, K., Ruane, A.C., Aggarwal, P.K., Ahmed, M., Balković, J., Basso, B., Biernath, C., Bindi, M., Cammarano, D., Challinor, A.J., De Sanctis, G., Dumont, B., Eyshi Rezaei, E., Fereres, E., Ferrise, R., Garcia-Vila, M., Gayler, S., Gao, Y., Horan, H., Hoogenboom, G., Izaurralde, R.C., Jabloun, M., Jones, C.D., Kassie, B.T., Kersebaum, K.-C., Klein, C., Koehler, A., Liu, B., Minoli, S., Montesino San Martin, M., Müller, C., Naresh Kumar, S., Nendel, C., Olesen, J.E., Palosuo, T., Porter, J.R., Priesack, E., Ripoche, D., Semenov, M.A., Stöckle, C., Stratonovitch, P., Streck, T., Supit, I., Tao, F., Van der Velde, M., Wallach, D., Wang, E., Webber, H., Wolf, J., Xiao, L., Zhang, Z., Zhao, Z., Zhu, Y., Ewert, F., 2018. Climate change impact and adaptation for wheat protein. *Glob. Chang. Biol.* 25, 155–173. <https://doi.org/10.1111/gcb.14481>.
- Basso, B., Ritchie, J.T., Pierce, F.J., Braga, R.P., Jones, J.W., 2001. Spatial validation of crop models for precision agriculture. *Agric. Syst.* 68, 97–112. [https://doi.org/10.1016/S0308-521X\(00\)00063-9](https://doi.org/10.1016/S0308-521X(00)00063-9).
- Basso, B., Cammarano, D., Chen, D., Cafiero, G., Amato, M., Bitella, G., Rossi, R., Basso, F., 2009. Landscape position and precipitation effects on spatial variability of wheat yield and grain protein in southern Italy. *J. Agron. Crop Sci.* 195, 301–312. <https://doi.org/10.1111/j.1439-037X.2008.00351.x>.
- Basso, B., Fiorentino, C., Cammarano, D., Cafiero, G., Dardanelli, J., 2012. Analysis of rainfall distribution on spatial and temporal patterns of wheat yield in Mediterranean environment. *Eur. J. Agron.* 41, 52–65. <https://doi.org/10.1016/j.eja.2012.03.007>.
- Brisson, N., Mary, B., Ripoche, D., Jeuffroy, M.-H., Ruget, F., Gate, P., Devienne-Barret, F., Antonioletti, R., Durr, C., Nicoullaud, B., Richard, G., Beaudoin, N., Recous, S., Tayot, X., Plenet, D., Cellier, P., Mached, J.M., Meynard, J.M., Delecqle, R., 1998. STICS: a generic model for simulating crops and their water and nitrogen balances. I. Theory and parametrization applied to wheat and corn. *Agronomie* 18, 311–346. <https://doi.org/10.1051/agro:19980501>.
- Brisson, N., Ruget, F., Gate, P., Lorgeou, J., Nicoullaud, B., Tayot, X., Plenet, D., Jeuffroy, M.-H., Bouthier, A., Ripoche, D., Mary, B., Justes, E., 2002. STICS: a generic model for simulating crops and their water and nitrogen balances. II. Model validation for wheat and maize. *Agronomie* 22, 69–93. <https://doi.org/10.1051/agro:2001005>.
- Brisson, N., Gary, C., Justes, E., Roche, R., Mary, B., Ripoche, D., Zimmer, D., Sierra, J., Bertuzzi, P., Burger, P., Bussière, F., Cabidoche, Y.M., Cellier, P., Debaeke, P., Gaudillère, J.P., Hénault, C., Maraux, F., Seguin, B., Sinoquet, H., 2003. An overview of the crop model stics. *Eur. J. Agron.* 18, 309–332. [https://doi.org/10.1016/S1161-0301\(02\)00110-7](https://doi.org/10.1016/S1161-0301(02)00110-7).
- Buttafuoco, G., Castrignanò, A., Colecchia, A.S., Ricca, N., 2010. Delineation of management zones using soil properties and a multivariate geostatistical approach. *Ital. J. Agron.* 5, 323. <https://doi.org/10.4081/ija.2010.323>.
- Buttafuoco, G., Castrignanò, A., Cucci, G., Locola, G., Lucà, F., 2017. Geostatistical modelling of within-field soil and yield variability for management zones delineation: a case study in a durum wheat field. *Precis. Agric.* 18, 37–58. <https://doi.org/10.1007/s11119-016-9462-9>.
- Cammarano, D., Basso, B., Holland, J., Gianinetti, A., Baronchelli, M., Ronga, D., 2021. Modeling spatial and temporal optimal N fertilizer rates to reduce nitrate leaching while improving grain yield and quality in malting barley. *Comput. Electron. Agric.* 182, 105997. <https://doi.org/10.1016/j.compag.2021.105997>.
- Celette, F., Ripoche, A., Gary, C., 2010. WaLIS—A simple model to simulate water partitioning in a crop association: the example of an intercropped vineyard. *Agric. Water Manag.* 97, 1749–1759. <https://doi.org/10.1016/j.agwat.2010.06.008>.
- Challinor, A.J., Ewert, F., Arnold, S., Simelton, E., Fraser, E., 2009. Crops and climate change: progress, trends, and challenges in simulating impacts and informing adaptation. *J. Exp. Bot.* 60, 2775–2789. <https://doi.org/10.1093/jxb/erp062>.
- Challinor, A.J., Müller, C., Asseng, S., Deva, C., Nicklin, K., Wallach, D., Vanuytrecht, E., Whitfield, S., Ramirez-Villegas, J., Koehler, A.-K., 2017. Improving the use of crop models for risk assessment and climate change adaptation. *Agric. Syst.* 159, 296–306. <https://doi.org/10.1016/j.agry.2017.07.010>.
- Corwin, D.L., Lesch, S.M., 2005. Apparent soil electrical conductivity measurements in agriculture. *Comput. Electron. Agric.* 46, 11–43. <https://doi.org/10.1016/j.compag.2004.10.005>.
- Dalglish, N., Hochman, Z., Huth, N., Holzworth, D., 2016. Field Protocol to APSOIL Characterisations - Version 4. CSIRO, Australia.
- Diacono, M., Castrignanò, A., Troccoli, A., De Benedetto, D., Basso, B., Rubino, P., 2012. Spatial and temporal variability of wheat grain yield and quality in a Mediterranean environment: a multivariate geostatistical approach. *Field Crop Res.* 131, 49–62. <https://doi.org/10.1016/j.fcr.2012.03.004>.
- van Evert, F.K., Cammarano, D., Kempenaar, C., 2023. Introduction. In: Cammarano, D., van Evert, F.K., Kempenaar, C. (Eds.), *Precision Agriculture: Modelling*. Springer, Cham, pp. 3–24.
- Faivre, R., Leenhardt, D., Voltz, M., Benoît, M., Papy, F., Dedieu, G., Wallach, D., 2004. Spatialising crop models. *Agronomie* 24, 205–217. <https://doi.org/10.1051/agro:2004016>.
- Guastaferro, F., Castrignanò, A., De Benedetto, D., Sollitto, D., Troccoli, A., Cafarelli, B., 2010. A comparison of different algorithms for the delineation of management zones. *Precis. Agric.* 11, 600–620. <https://doi.org/10.1007/s11119-010-9183-4>.
- Guillaume, S., Lablée, J.L., 2022. GeoFIS: Spatial Data Processing for Decision Making R Package Version 1.0.3.
- Guo, C., Zhang, L., Zhou, X., Zhu, Y., Cao, W., Qiu, X., Cheng, T., Tian, Y., 2018. Integrating remote sensing information with crop model to monitor wheat growth and yield based on simulation zone partitioning. *Precis. Agric.* 19, 55–78. <https://doi.org/10.1007/s11119-017-9498-5>.
- Hansen, S., Jensen, H.E., Nielsen, N.E., 1991. Simulation of nitrogen dynamics and biomass production in winter wheat using the Danish simulation model daisy. *Fertil. Res.* 27, 245–259.
- Hansen, S., Abrahamsen, P., Petersen, C.T., Styczen, M., 2012. Daisy: model use, calibration, and validation. *Trans. ASABE* 55, 1315–1333. <https://doi.org/10.13031/2013.42244>.
- Hao, S., Ryu, D., Western, A., Perry, E., Bogen, H., Franssen, H.J.H., 2021. Performance of a wheat yield prediction model and factors influencing the performance: a review and meta-analysis. *Agric. Syst.* 194, 103278. <https://doi.org/10.1016/j.agry.2021.103278>.
- Heuvelink, G.B.M., Brus, D.J., Reinds, G., 2010. Accounting for spatial sampling effects in regional uncertainty propagation analysis. In: Presented at the 9th International Symposium on Spatial Accuracy Assessment in Natural Resources and Environmental Sciences, Leicester, UK, pp. 85–88.
- Hochman, Z., Horan, H., 2018. Causes of wheat yield gaps and opportunities to advance the water-limited yield frontier in Australia. *Field Crop Res.* 228, 20–30. <https://doi.org/10.1016/j.fcr.2018.08.023>.
- Hollis, J.M., Hannam, J., Bellamy, P.H., 2012. Empirically-derived pedotransfer functions for predicting bulk density in European soils. *Eur. J. Soil Sci.* 63, 96–109. <https://doi.org/10.1111/j.1365-2389.2011.01412.x>.
- Holzworth, D.P., Huth, N.I., deVoil, P.G., Zurcher, E.J., Herrmann, N.I., McLean, G., Chenu, K., van Oosterom, E.J., Snow, V., Murphy, C., Moore, A.D., Brown, H., Whish, J.P.M., Verrall, S., Fainges, J., Bell, L.W., Peake, A.S., Poulton, P.L., Hochman, Z., Thorburn, P.J., Gaydon, D.S., Dalglish, N.P., Rodriguez, D., Cox, H., Chapman, S., Doherty, A., Teixeira, E., Sharp, J., Cichota, R., Vogeler, I., Li, F.Y., Wang, E., Hammer, G.L., Robertson, M.J., Dimes, J.P., Whitbread, A.M., Hunt, J., van Rees, H., McClelland, T., Carberry, P.S., Hargreaves, J.N.G., MacLeod, N., McDonald, C., Harsdorf, J., Wedgwood, S., Keating, B.A., 2014. APSIM – evolution

- towards a new generation of agricultural systems simulation. *Environ. Model Softw.* 62, 327–350. <https://doi.org/10.1016/j.envsoft.2014.07.009>.
- Hoogenboom, G., Porter, C.H., Boote, K.J., Shelia, V., Wilkens, P.W., Singh, U., White, J.W., Asseng, S., Lizaso, J.I., Moreno, L.P., Pavan, W., Ogoshi, R., Hunt, L.A., Tsuji, G. Y., Jones, J.W., 2019. The DSSAT crop modeling ecosystem. In: *Advances in Crop Modeling for a Sustainable Agriculture*. Burleigh Dodds Science Publishing, Cambridge, United Kingdom, pp. 173–216. <https://doi.org/10.19103/AS.2019.0061.10>.
- Hoogenboom, G., Porter, C.H., Shelia, V., Boote, K.J., Singh, U., White, J.W., Pavan, W., Oliveira, F.A.A., Moreno-Cadena, L.P., Lizaso, J.I., Asseng, S., Pequeno, D.N.L., Kimball, B.A., Alderman, P.D., Thorp, K.R., Jones, M.R., Cuadra, S.V., Vianna, M.S., Villalobos, F.J., Ferreira, T.B., Batchelor, W.D., Koo, J., Hunt, L.A., Jones, J.W., 2021. *Decision Support System for Agrotechnology Transfer (DSSAT)*.
- Hsiao, T.C., Heng, L., Steduto, P., Rojas-Lara, B., Raes, D., Fereres, E., 2009. AquaCrop - the FAO crop model to simulate yield response to water: III. parameterization and testing for Maize. *Agron. J.* 101, 448–459. <https://doi.org/10.2134/agronj2008.0218s>.
- Hu, S., Shi, L., Huang, K., Zha, Y., Hu, X., Ye, H., Yang, Q., 2019. Improvement of sugarcane crop simulation by SWAP-WOFOST model via data assimilation. *Field Crop Res.* 232, 49–61. <https://doi.org/10.1016/j.fcr.2018.12.009>.
- Huang, J., Gómez-Dans, J.L., Huang, H., Ma, H., Wu, Q., Lewis, P.E., Liang, S., Chen, Z., Xue, J.-H., Wu, Y., Zhao, F., Wang, J., Xie, X., 2019. Assimilation of remote sensing into crop growth models: current status and perspectives. *Agric. For. Meteorol.* 276–277, 107609. <https://doi.org/10.1016/j.agrformet.2019.06.008>.
- Huth, N.I., Bristow, K.L., Verburg, K., 2012. SWIM3: model use, calibration, and validation. *Trans. ASABE* 55, 1303–1313. <https://doi.org/10.13031/2013.42243>.
- van Ittersum, M.K., Leffelaar, P.A., van Keulen, H., Kropff, M.J., Bastiaans, L., Goudriaan, J., 2003. On approaches and applications of the Wageningen crop models. *Eur. J. Agron.* 18, 201–234. [https://doi.org/10.1016/S1161-0301\(02\)00106-5](https://doi.org/10.1016/S1161-0301(02)00106-5).
- van Ittersum, M.K., Cassman, K.G., Grassini, P., Wolf, J., Tittonell, P., Hochman, Z., 2013. Yield gap analysis with local to global relevance—a review. *Field Crop Res.* 143, 4–17. <https://doi.org/10.1016/j.fcr.2012.09.009>.
- IUSS Working Group WRB, 2015. *World Reference Base for Soil Resources 2014, Update 2015, International Soil Classification System for Naming Soils and Creating Legends for Soil Maps, World Soil Resources Reports No. 106*. FAO, Rome.
- Ji, G., Tian, L., Zhao, J., Yue, Y., Wang, Z., Yang, X., 2018. Error analysis and correction of spatialization of crop yield in China – different variables scales, partitioning schemes and error correction methods. *Comput. Electron. Agric.* 148, 272–279. <https://doi.org/10.1016/j.compag.2018.03.031>.
- Jin, X., Kumar, L., Li, Z., Feng, H., Xu, X., Yang, G., Wang, J., 2018. A review of data assimilation of remote sensing and crop models. *Eur. J. Agron.* 92, 141–152. <https://doi.org/10.1016/j.eja.2017.11.002>.
- Jones, J.W., Hoogenboom, G., Porter, C.H., Boote, K.J., Batchelor, W.D., Hunt, L.A., Wilkens, P.W., Singh, U., Gijsman, A.J., Ritchie, J.T., 2003. The DSSAT cropping system model. *Eur. J. Agron.* 18, 235–265. [https://doi.org/10.1016/S1161-0301\(02\)00107-7](https://doi.org/10.1016/S1161-0301(02)00107-7).
- Jones, J.W., Antle, J.M., Basso, B., Boote, K.J., Conant, R.T., Foster, I., Godfray, H.C.J., Herrero, M., Howitt, R.E., Janssen, S., Keating, B.A., Munoz-Carpena, R., Porter, C. H., Rosenzweig, C., Wheeler, T.R., 2017. Brief history of agricultural systems modeling. *Agric. Syst.* 155, 240–254. <https://doi.org/10.1016/j.agry.2016.05.014>.
- Khanal, S., Fulton, J., Shearer, S., 2017. An overview of current and potential applications of thermal remote sensing in precision agriculture. *Comput. Electron. Agric.* 139, 22–32. <https://doi.org/10.1016/j.compag.2017.05.001>.
- Krajewski, W.F., Ciach, G.J., Habib, E., 2003. An analysis of small-scale rainfall variability in different climatic regimes. *Hydrol. Sci. J.* 48, 151–162. <https://doi.org/10.1623/hysj.48.2.151.44694>.
- Launay, M., Guerif, M., 2005. Assimilating remote sensing data into a crop model to improve predictive performance for spatial applications. *Agric. Ecosyst. Environ.* 111, 321–339. <https://doi.org/10.1016/j.agee.2005.06.005>.
- Leo, S., De Antoni Migliorati, M., Nguyen, T.H., Grace, P.R., 2023. Combining remote sensing-derived management zones and an auto-calibrated crop simulation model to determine optimal nitrogen fertilizer rates. *Agric. Syst.* 205, 103559. <https://doi.org/10.1016/j.agry.2022.103559>.
- Leroux, C., Tisseyre, B., 2018. How to measure and report within-field variability: a review of common indicators and their sensitivity. *Precis. Agric.* 20, 562–590. <https://doi.org/10.1007/s11119-018-9598-x>.
- Lobell, D.B., Burke, M.B., Tebaldi, C., Mastrandrea, M.D., Falcon, W.P., Naylor, R.L., 2008. Prioritizing climate change adaptation needs for food security in 2030. *Sci.* 319, 607–610. <https://doi.org/10.1126/science.1152339>.
- Maestrini, B., Basso, B., 2018. Predicting spatial patterns of within-field crop yield variability. *Field Crop Res.* 219, 106–112. <https://doi.org/10.1016/j.fcr.2018.01.028>.
- Miguez, F.E., 2022. *apsimx: Inspect, Read, Edit and Run “APSIM” “Next Generation” and “APSIM” Classic R Package Version 2.3.1*.
- Mon, J., Bronson, K.F., Hunsaker, D.J., Thorp, K.R., White, J.W., French, A.N., 2016. Interactive effects of nitrogen fertilization and irrigation on grain yield, canopy temperature, and nitrogen use efficiency in overhead sprinkler-irrigated durum wheat. *Field Crop Res.* 191, 54–65. <https://doi.org/10.1016/j.fcr.2016.02.011>.
- Nawar, S., Corstjanje, R., Halcro, G., Mulla, D., Mouazen, A.M., 2017. Delineation of soil management zones for variable-rate fertilization. In: *Advances in Agronomy*. Elsevier, pp. 175–245. <https://doi.org/10.1016/bs.agron.2017.01.003>.
- Nendel, C., Berg, M., Kersebaum, K.C., Mirschel, W., Specka, X., Wegehinkel, M., Wenkel, K.O., Wieland, R., 2011. The MONICA model: testing predictability for crop growth, soil moisture and nitrogen dynamics. *Ecol. Model.* 222, 1614–1625. <https://doi.org/10.1016/j.ecolmodel.2011.02.018>.
- Pasquel, D., Roux, S., Richetti, J., Cammarano, D., Tisseyre, B., Taylor, J.A., 2022a. A review of methods to evaluate crop model performance at multiple and changing spatial scales. *Precis. Agric.* 23, 1489–1513. <https://doi.org/10.1007/s11119-022-09885-4>.
- Pasquel, D., Roux, S., Tisseyre, B., Taylor, J.A., 2022b. Comparison of different aspatial and spatial indicators to assess performance of spatialized crop models at different within-field scales. In: *Presented at the 15th International Conference on Precision Agriculture*, Minneapolis, Minnesota, USA.
- Pasquel, D., Roux, S., Tisseyre, B., Taylor, J.A., 2023. A new metric to evaluate spatial crop model performances. In: *Presented at the 14th European Conference on Precision Agriculture*, Bologna, Italy, pp. 603–609. <https://doi.org/10.3920/978-90-8686-947-3.76>.
- Pedroso, M., Taylor, J., Tisseyre, B., Charnomordic, B., Guillaume, S., 2010. A segmentation algorithm for the delineation of agricultural management zones. *Comput. Electron. Agric.* 70, 199–208. <https://doi.org/10.1016/j.compag.2009.10.007>.
- Porwollik, V., Müller, C., Elliott, J., Chryssanthacopoulos, J., Iizumi, T., Ray, D.K., Ruane, A.C., Arneith, A., Balković, J., Ciaia, P., Deryng, D., Folberth, C., Izaurrealde, R. C., Jones, C.D., Khabarov, N., Lawrence, P.J., Liu, W., Pugh, T.A.M., Reddy, A., Sakurai, G., Schmid, E., Wang, X., de Wit, A., Wu, X., 2017. Spatial and temporal uncertainty of crop yield aggregations. *Eur. J. Agron.* 88, 10–21. <https://doi.org/10.1016/j.eja.2016.08.006>.
- R Core Team, 2022. *R: A Language and Environment for Statistical Computing*.
- Raes, D., Steduto, P., Hsiao, T.C., Fereres, E., 2009. AquaCrop - the FAO crop model to simulate yield response to water: II. Main algorithms and software description. *Agron. J.* 101, 438–447. <https://doi.org/10.2134/agronj2008.0140s>.
- Rötter, R.P., Palosuo, T., Kersebaum, K.C., Angulo, C., Bindi, M., Ewert, F., Ferrise, R., Hlavinka, P., Moriondo, M., Nendel, C., Olesen, J.E., Patil, R.H., Ruget, F., Takáč, J., Trnka, M., 2012. Simulation of spring barley yield in different climatic zones of northern and Central Europe: a comparison of nine crop models. *Field Crop Res.* 133, 23–36. <https://doi.org/10.1016/j.fcr.2012.03.016>.
- Seidel, S.J., Palosuo, T., Thorburn, P., Wallach, D., 2018. Towards improved calibration of crop models – where are we now and where should we go? *Eur. J. Agron.* 94, 25–35. <https://doi.org/10.1016/j.eja.2018.01.006>.
- Shelia, V., Šimůnek, J., Boote, K., Hoogenboom, G., 2018. Coupling DSSAT and HYDRUS-1D for simulations of soil water dynamics in the soil-plant-atmosphere system. *J. Hydrol. Hydromech.* 66, 232–245. <https://doi.org/10.1515/johh-2017-0055>.
- Soltani, A., Sinclair, T.R., 2015. A comparison of four wheat models with respect to robustness and transparency: simulation in a temperate, sub-humid environment. *Field Crop Res.* 175, 37–46. <https://doi.org/10.1016/j.fcr.2014.10.019>.
- Steduto, P., Hsiao, T.C., Raes, D., Fereres, E., 2009. AquaCrop - the FAO crop model to simulate yield response to water: I. concepts and underlying principles. *Agron. J.* 101, 426–437. <https://doi.org/10.2134/agronj2008.0139s>.
- Subedi, M., Fullen, M.A., 2009. Spatial variability in precipitation within the Hilton experimental site, Shropshire, UK (1982–2006). *Hydrol. Process.* 23, 236–244. <https://doi.org/10.1002/hyp.7133>.
- Sudduth, K.A., Drummond, S.T., Kitchen, N.R., 2001. Accuracy issues in electromagnetic induction sensing of soil electrical conductivity for precision agriculture. *Comput. Electron. Agric.* 31, 239–264. [https://doi.org/10.1016/S0168-1699\(00\)00185-X](https://doi.org/10.1016/S0168-1699(00)00185-X).
- Villa, A., Eckersten, H., Gaiser, T., Ahrends, H.E., Lewan, E., 2022. Aggregation of soil and climate input data can underestimate simulated biomass loss and nitrate leaching under climate change. *Eur. J. Agron.* 141, 126630. <https://doi.org/10.1016/j.eja.2022.126630>.
- Wallach, D., Palosuo, T., Thorburn, P., Hochman, Z., Gourdain, E., Andrianasolo, F., Asseng, S., Basso, B., Buis, S., Crout, N., Dibari, C., Dumont, B., Ferrise, R., Gaiser, T., Garcia, C., Gayler, S., Ghahramani, A., Hiremath, S., Hoek, S., Horan, H., Hoogenboom, G., Huang, M., Jabloun, M., Janssen, P.-E., Jing, Q., Justes, E., Kersebaum, K.C., Klosterhalfen, A., Launay, M., Lewan, E., Luo, Q., Maestrini, B., Mielenz, H., Moriondo, M., Nariman Zadeh, H., Padovan, G., Olesen, J.E., Poyda, A., Priesack, E., Pullens, J.W.M., Qian, B., Schütze, N., Shelia, V., Souissi, A., Specka, X., Srivastava, A.K., Stella, T., Streck, T., Trombi, G., Wallor, E., Wang, J., Weber, T.K.D., Weiermüller, L., de Wit, A., Wöhling, T., Xiao, L., Zhao, C., Zhu, Y., Seidel, S.J., 2021. The chaos in calibrating crop models: lessons learned from a multi-model calibration exercise. *Environ. Model Softw.* 145, 105206. <https://doi.org/10.1016/j.envsoft.2021.105206>.
- Wallor, E., Kersebaum, K.-C., Ventrella, D., Bindi, M., Cammarano, D., Coucheny, E., Gaiser, T., Garofalo, P., Giglio, L., Giola, P., Hoffmann, M.P., Iocola, I., Lana, M., Lewan, E., Maharjan, G.R., Moriondo, M., Mula, L., Nendel, C., Pohankova, E., Roggero, P.P., Trnka, M., Trombi, G., 2018. The response of process-based agro-ecosystem models to within-field variability in site conditions. *Field Crop Res.* 228, 1–19. <https://doi.org/10.1016/j.fcr.2018.08.021>.
- Weiss, M., Jacob, F., Duveiller, G., 2020. Remote sensing for agricultural applications: a meta-review. *Remote Sens. Environ.* 236, 111402. <https://doi.org/10.1016/j.rse.2019.111402>.
- de Wit, A., Boogaard, H., Fumagalli, D., Janssen, S., Knapen, R., van Kraalingen, D., Supit, I., van der Wijngaart, R., van Diepen, K., 2019. 25 years of the WOFOST cropping systems model. *Agric. Syst.* 168, 154–167. <https://doi.org/10.1016/j.agry.2018.06.018>.
- Xiang, Z., Bailey, R.T., Nozari, S., Husain, Z., Kisekka, I., Sharda, V., Gowda, P., 2020. DSSAT-MODFLOW: a new modeling framework for exploring groundwater conservation strategies in irrigated areas. *Agric. Water Manag.* 232, 106033. <https://doi.org/10.1016/j.agwat.2020.106033>.
- Xu, H., Huang, F., Zuo, W., Tian, Y., Zhu, Y., Cao, W., Zhang, X., 2020. Impacts of spatial zonation schemes on yield potential estimates at the regional scale. *Agron.* 10, 631. <https://doi.org/10.3390/agronomy10050631>.

- You, Y., Tian, H., Pan, S., Shi, H., Bian, Z., Gurgel, A., Huang, Y., Kicklighter, D., Liang, X.-Z., Lu, C., Melillo, J., Miao, R., Pan, N., Reilly, J., Ren, W., Xu, R., Yang, J., Yu, Q., Zhang, J., 2022. Incorporating dynamic crop growth processes and management practices into a terrestrial biosphere model for simulating crop production in the United States: toward a unified modeling framework. *Agric. For. Meteorol.* 325, 109144. <https://doi.org/10.1016/j.agrformet.2022.109144>.
- Zhang, C., Kovacs, J.M., 2012. The application of small unmanned aerial systems for precision agriculture: a review. *Precis. Agric.* 13, 693–712. <https://doi.org/10.1007/s11119-012-9274-5>.
- Zhen, X., Huo, W., Tian, D., Zhang, Q., Sanz-Saez, A., Chen, C.Y., Batchelor, W.D., 2023. County level calibration strategy to evaluate peanut irrigation water use under different climate change scenarios. *Eur. J. Agron.* 143, 126693. <https://doi.org/10.1016/j.eja.2022.126693>.
- Zhuo, W., Fang, S., Gao, X., Wang, L., Wu, D., Fu, S., Wu, Q., Huang, J., 2022. Crop yield prediction using MODIS LAI, TIGGE weather forecasts and WOFOST model: a case study for winter wheat in Hebei, China during 2009–2013. *Int. J. Appl. Earth Obs. Geoinf.* 106, 102668. <https://doi.org/10.1016/j.jag.2021.102668>.