



HAL
open science

Variations intra-individuelles de données omiques L'Analyse Triadique Partielle Journée "Statistique et Génomique"

Denis Laloë, Tatiana Zerjal

► **To cite this version:**

Denis Laloë, Tatiana Zerjal. Variations intra-individuelles de données omiques L'Analyse Triadique Partielle Journée "Statistique et Génomique". École thématique. Journées Statistiques et Génomique, Paris, France. 2018. hal-04447190

HAL Id: hal-04447190

<https://hal.inrae.fr/hal-04447190>

Submitted on 8 Feb 2024

HAL is a multi-disciplinary open access archive for the deposit and dissemination of scientific research documents, whether they are published or not. The documents may come from teaching and research institutions in France or abroad, or from public or private research centers.

L'archive ouverte pluridisciplinaire **HAL**, est destinée au dépôt et à la diffusion de documents scientifiques de niveau recherche, publiés ou non, émanant des établissements d'enseignement et de recherche français ou étrangers, des laboratoires publics ou privés.

Variations intra-individuelles de données omiques

L'Analyse Triadique Partielle

Journée "Statistique et Génomique"

Denis Laloë & Tatiana Zerjal
GABI - PSGen

12 octobre 2018

Intégromique

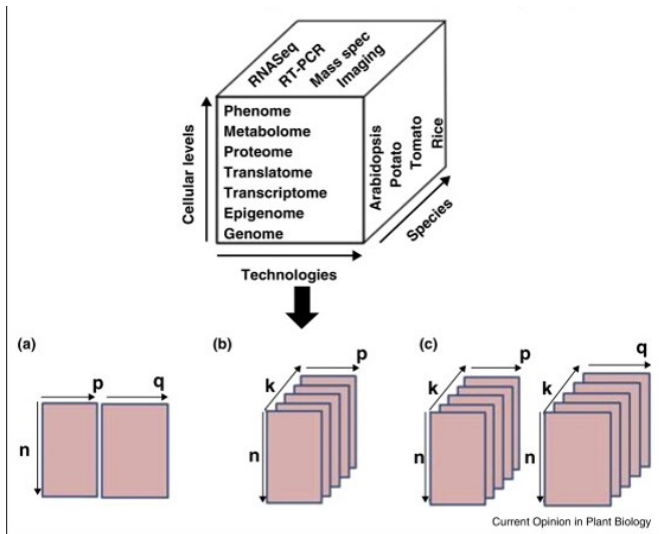

Analyse géométrique des données

Analyses multivariées

Analyses factorielles

- Approche descriptive / exploratoire
- Approche géométrique : représentation de données sous forme de nuages de points
- Graphiques

Le schéma de dualité

Observations / Variables

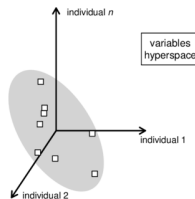
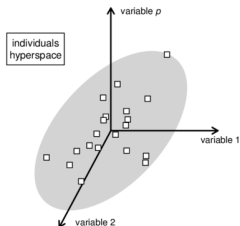
cloud of n rows (individuals)cloud of p columns (variables)

Le schéma de dualité

Observations / Variables

The same transformation mechanism

- Rotation
- Dimension reduction

Hyperspace of observations
 n points in \mathbb{R}^p

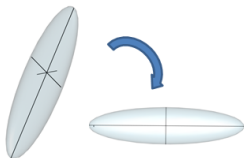

A measure of distance between
observations

Hyperspace of variables
 p points in \mathbb{R}^n

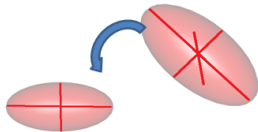

A measure of distance between
variables

A mathematical formalisation
The duality diagram theory

Le schéma de dualité

Observations / Variables

Maximisation of the correlation between variables and components

$$V = X'X/n$$

$$VA = \Lambda$$

$$A'A = I$$

Principal axes

$$\text{Variable scores}$$

$$C = X'B$$

Best approximation (rank l)
Eckart and Young

$$\begin{array}{ccc} & Q = I_p & \\ \langle p \rangle & \xrightarrow{\quad} & \langle p \rangle \\ X^t \uparrow & & \downarrow X \\ \langle n \rangle & \xleftarrow{\quad} & \langle n \rangle \\ & M = \frac{I_n}{n} & \end{array}$$

Diagonalisation

$$X'X \quad \quad \quad XX'$$

mêmes valeurs propres non nulles
 $\lambda_1 > \lambda_2 > \dots > \lambda_r > 0$
 $\Lambda = \text{diag}(\lambda_1, \dots, \lambda_r)$

Transition formulae

$$X\Lambda^{-0,5} = B$$

$$X'B\Lambda^{-0,5} = A$$

Singular value decomposition

$$X = B\Lambda^{0,5}A'$$

$$\hat{X}_l = \sum_{i=1,l} \sqrt{\lambda_i} b_i a_i'$$

Maximisation of the dispersion of individuals

Observations

$$W = XX' / n$$

$$WB = \Lambda$$

$$B'B = I$$

Principal components

Observation scores

$$L = XA$$

Déclinaison du schéma de dualité

Analyse	Nature des données	Tableau de données	Pondération lignes	Pondérations colonnes
ACP	Quantitatif	$\frac{x_{ij} - x_{.j}}{s_j}$	$\frac{1}{n}$	I
AFC NS	Tableau de contingence	$\frac{f_{ij} - f_{i.} f_{.j}}{f_{i.} f_{.j}}$	$diag(f_{1.}, \dots, f_{i.})$	I
AFC	Tableau de contingence	$\frac{f_{ij} - f_{i.} f_{.j}}{f_{i.} f_{.j}}$	$f_{i.}$	$f_{.j}$
ACM	Qualitatif (tableau disjonctif)	$\frac{\delta_{ikj} - f_{kj}}{f_{kj}}$	$\frac{1}{n}$	$diag(f_i)/n$ facteurs

Analyses multitables

Ensemble d'individus décrits par plusieurs groupes de variables

- Relations entre tableaux (interstructure)
- Recherche d'un compromis
- Intrastructure, trajectoires (comment une analyse partielle reproduit l'analyse compromis)

Analyses multitables

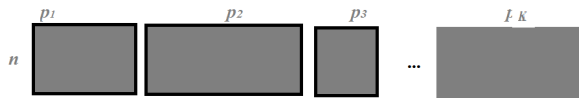

Plusieurs tableaux

- Corrélations canoniques généralisées
- Co-inertie multiple
- STATIS
- Analyse Factorielle Multiple

Analyse Triadique Partielle

Thioulouse et Chessel, 1987

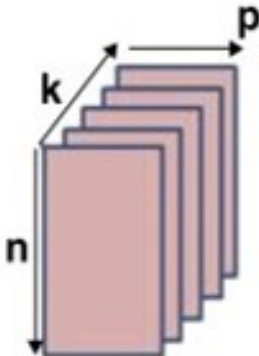

Analyse d'un cube de données, vu comme une séquence de tables à deux dimensions

Analyse Triadique Partielle

Bertrand & Maumy, 2010

<http://www.bentley.edu/csbigs/Vol4-1/bertrand.pdf>

Using Partial Triadic Analysis for Depicting the Temporal Evolution of Spatial Structures: Assessing Phytoplankton Structure and Succession in a Water Reservoir

■ K tables

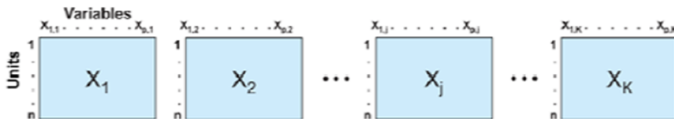

■ Common typology: the « compromise »



Interstructure: similarities between the different tables

Compromise: Common structure derived from each table

2

Analyse Triadique Partielle

Interstructure

Relation entre deux tableaux (mêmes lignes, mêmes colonnes) : R_v coefficient

$$R_v(X_k, X_{k'}) = \frac{\text{Cov}_v(X_k, X_{k'})}{\sqrt{\text{Var}_v(X_k)}\sqrt{\text{Var}_v(X_{k'})}}$$

$$= \frac{\sum_{i=1}^p \text{cor}(X_j^i, X_k^i)}{p}$$

- Calcul des p corrélations gène à gène
- R_v : moyenne des p corrélations

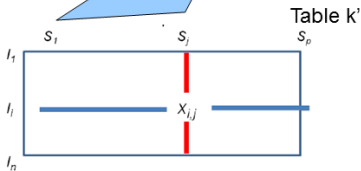
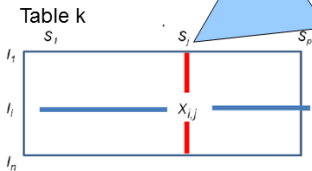

Analyse Triadique Partielle

Fig. 1. General scheme of the Partial Triadic Analysis: construction of the interstructure matrix Y and extraction of the compromise table Z . The interstructure between matrices $X_1 \dots X_t$ corresponding to the sampling dates is analysed by a simple PCA of Y . The compromise tables are derived from the coordinates of the variables at the different sites on the principal components of the PCA of Y . The figure illustrates the construction of the first compromise table from the first principal component of the simple PCA of Y . Compromise tables are then analysed by a simple PCA

Rossi, (*Pedobiologia*, 2003)

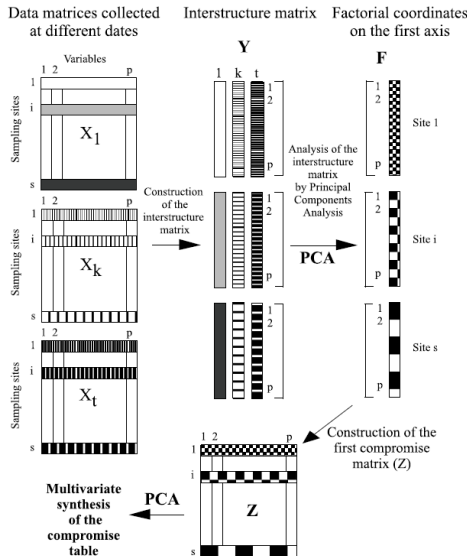

Projet Chickstress

- 2 lignées de poules R+, R-
- Adaptation à un régime suboptimal
- 4 groupes Lignées * Traitement
- Pour chaque individu, transcriptome sur 4 tissus:
 - Foie,
 - Sang,
 - Tissu adipeux,
 - Hypothalamus

Analyses entre groupes

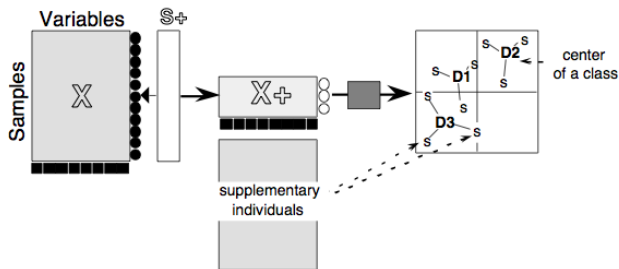

Dufour, 2010

- Alternative robuste à l'analyse discriminante;
- Modélisation (PCAIV / Analyse de redondance);
- Tests de permutation

Analyse Triadique Partielle / ACP entre groupes

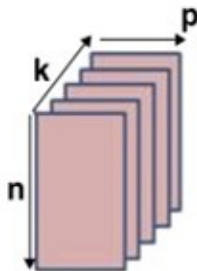

- $n = 4$ (112 individus, dans 4 groupes Lignées * Traitement),
- $k = 4$ (4 tissus)
- $p = 4286$ (Gènes exprimés dans les 4 tissus)

Interstructure

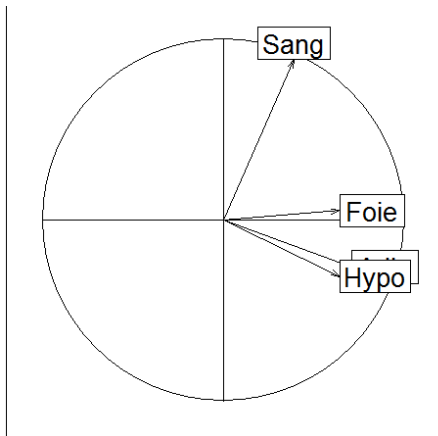

	Adip	Sang	Hypo	Foie
Adip	1.00	0.09	0.25	0.23
Sang	0.09	1.00	0.08	0.12
Hypo	0.25	0.08	1.00	0.16
Foie	0.23	0.12	0.16	1.00

ACP entre groupes

Analyses séparées par tissu

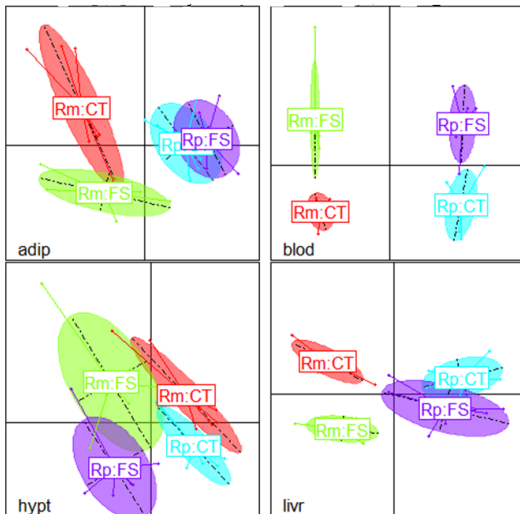

Compromis

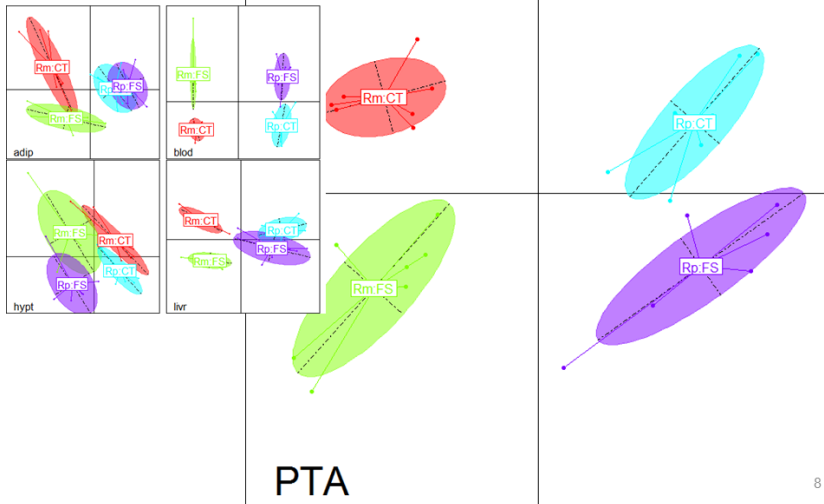

Compromis et Intrastructure

k tables $\longrightarrow k + 1$ points

- k points par analyse séparée
- 1 point compromis, au centre des k points

Compromis et Intrastructure

Les groupes d'animaux

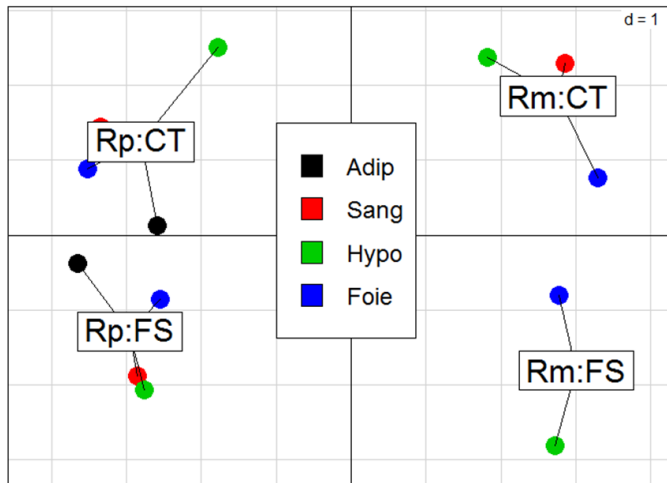

Compromis et Infrastructure

Les gènes

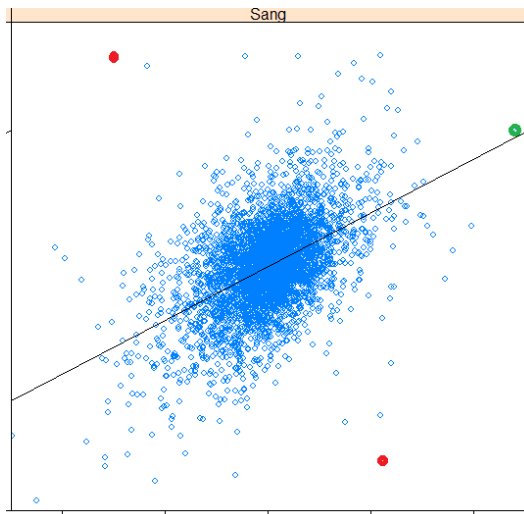

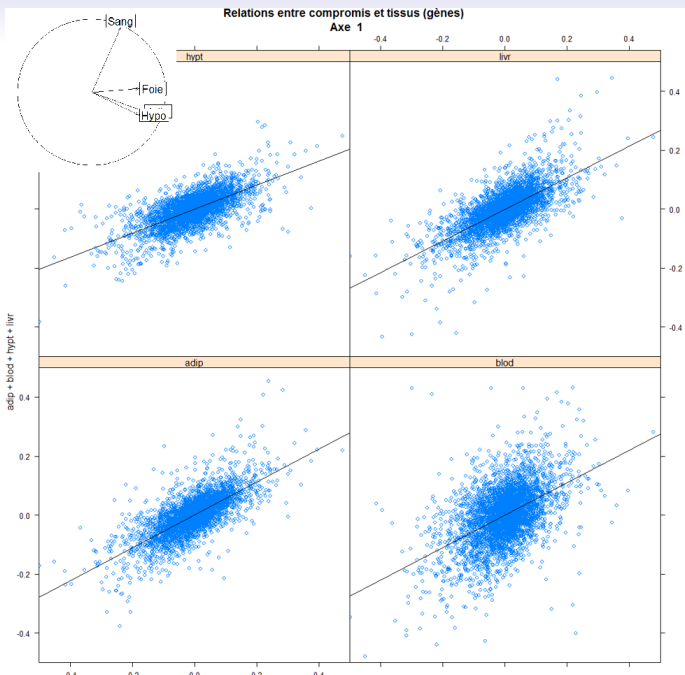

Conclusion

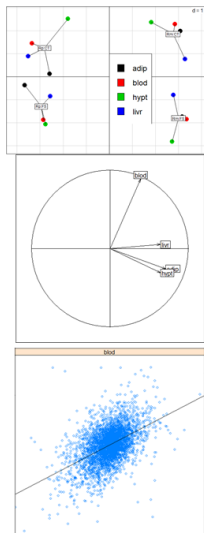

- Identification d'une structure compromis entre individus ou groupes
- Relations entre les transcriptomes des tissus produisant cette structure compromis
- Relations entre l'expression des gènes selon les tissus

Conclusion

Pourquoi "Partiel"

A) PTA focusing on the temporal variability of spatial structures

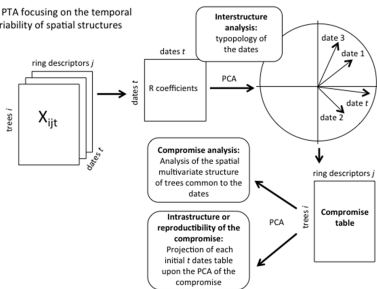

B) PTA focusing on the spatial structure of temporal trajectories

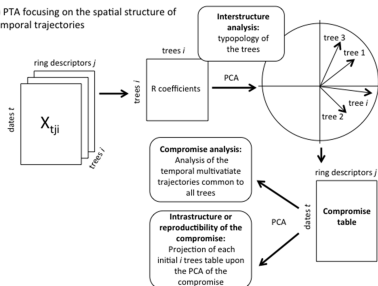

Rossi et al, 2014

Conclusion - Extensions

STATICO

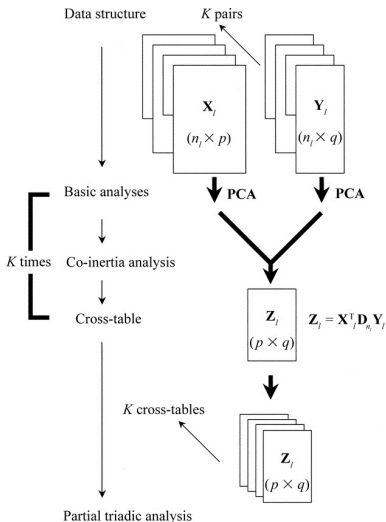

Références

- Bertrand, F., & Maumy, M. (2010). Using partial triadic analysis for depicting the temporal evolution of spatial structures: assessing phytoplankton structure and succession in a water reservoir. *Case Studies Business, Industry Govern Stat*, 4, 23-43.
- Dufour, A.B., 2010. Les analyses en composantes principales inter et intra-classes. <https://pbil.univ-lyon1.fr/R/pdf/tdr621.pdf>
- Rajasundaram, D., & Selbig, J. (2016). More effort?more results: recent advances in integrative ?omics? data analysis. *Current opinion in plant biology*, 30, 57-61.
- Rossi, J. P., Nardin, M., Godefroid, M., Ruiz-Diaz, M., Sergent, A. S., Martinez-Meier, A., ... & Rozenberg, P. (2014). Dissecting the space-time structure of tree-ring datasets using the partial triadic analysis. *PLoS one*, 9(9), e108332
- Thioulouse, J., & Chessel, D. (1987). Multi-table analysis of ecological factors. I. From description of ecosystem status to that of ecosystem function using triadic analysis. *ACTA OECOL., OECOL. GEN.*, 8(4), 463-480.
- Thioulouse, J., Simier, M., & Chessel, D. (2004). Simultaneous analysis of a sequence of paired ecological tables. *Ecology*, 85(1), 272-283.
- ade4. <http://pbil.univ-lyon1.fr/ade4/>. Dray, S., & Dufour, A. B. (2007). The ade4 package: implementing the duality diagram for ecologists. *Journal of statistical software*, 22(4), 1-20.
- ExPosition. cf Beaton, D., Fatt, C. R. C., et Abdi, H. (2014). An ExPosition of multivariate analysis with the singular value decomposition in R. *Computational Statistics & Data Analysis*, 72, 176-189.