



HAL
open science

WheatIS data discovery

Michael Alaux

► **To cite this version:**

Michael Alaux. WheatIS data discovery. PAG XXVII - Plant and Animal Genome Conference, Jan 2019, San Diego, United States. hal-04536596

HAL Id: hal-04536596

<https://hal.inrae.fr/hal-04536596>

Submitted on 8 Apr 2024

HAL is a multi-disciplinary open access archive for the deposit and dissemination of scientific research documents, whether they are published or not. The documents may come from teaching and research institutions in France or abroad, or from public or private research centers.

L'archive ouverte pluridisciplinaire **HAL**, est destinée au dépôt et à la diffusion de documents scientifiques de niveau recherche, publiés ou non, émanant des établissements d'enseignement et de recherche français ou étrangers, des laboratoires publics ou privés.



Distributed under a Creative Commons Attribution 4.0 International License

WheatIS data discovery

Michael Alaux

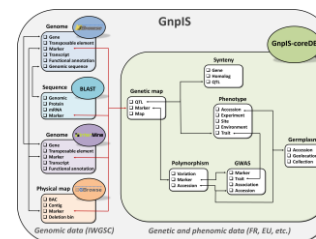

New architecture

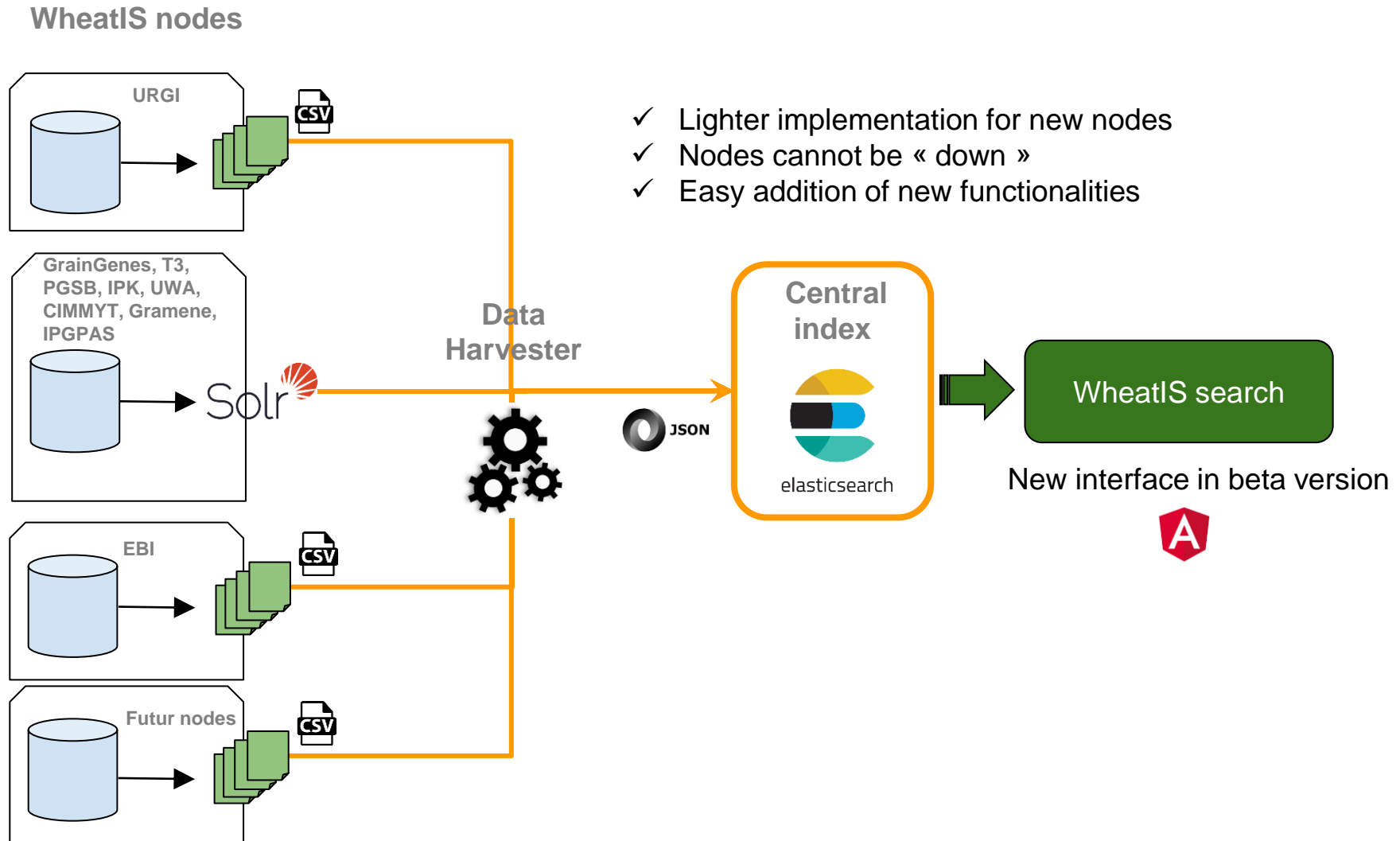

New beta version



[Wheat@URGI](#) [WheatIS](#) [Wheat Initiative](#)

URGI

[IWGSC@GnpIS](#) [18 566 139]
[GnpIS](#) [92 214]
[OpenMinTeD](#) [3 398]
[WheatIS File Repository](#) [6]

EBI

[Ensembl Plants](#) [2 122 980]

IPK

[CR-EST](#) [199 220]
[GEBIS](#) [50 875]
[MetaCrop](#) [177]

Gramene

[Gramene](#) [229 789]

UWA

[Wheat Pangenome](#) [167 167]

T3

[The Triticeae Toolbox](#) [138 441]

South Green

[AgroLD](#) [137 060]

Rothamsted Research

[KNetMiner](#) [110 775]

GrainGenes

[GrainGenes](#) [15 827]
[Wheat Gene Catalog at
Komugi](#) [3 043]

PGSB

[CrowsNest](#) [13 324]

CIMMYT

[CIMMYT Dspace](#) [981]
[CIMMYT dataverse](#) [1]

IPGPAS

[PlantPhenoDB](#) [3]

WheatIS

Wheat Information
System



Examples: yield, fhb

Search

New data

URGI

IWGSC@GnpIS [19 241 077] } Data added
GnpIS [156 827]

OpenMinTeD [3 398] Bibliography

WheatIS File Repository [6]

EBI

Ensembl Plants [2 391 552]

IPK

CR-EST [199 220]

GEBIS [51 302]

MetaCrop [355]

Gramene

Gramene [229 851]

T3

The Triticeae Toolbox [185 781]

UWA

Wheat Pangenome [167 167]

New data

South Green

AgroLD [137 060] Linked data

Rothamsted Research

KNetMiner [110 775] Knowledge networks

GrainGenes

GrainGenes [16 755] Data added: genes, maps, germplasm

Wheat Gene Catalog at
Komugi [3 119] Gene Catalog

PGSB

CrowsNest [13 324]

CIMMYT

CIMMYT Dspace [981]

CIMMYT dataverse [38]

IPGPAS

PlantPhenoDB [3]

New filters

FHB Search

Results 1 to 20 from 219

Data type

- Bibliography [123]
- Experiment [59]
- Phenotype [18]
- Accession [9]
- Genetic map [6]
- Gene [2]
- Physical map [1]
- Qtl [1]

[SUWWSN_2016_Fayetteville](#) - The Triticeae Toolbox
Experiment Triticum aestivum
Experiment Triticeae Toolbox SUWWSN_2016_Fayetteville phenotype trial traits=DON level **FHB** disease index **FHB** incidence **FHB** severity **FHB** grain incidence **FHB** ISK index Southern Uniform Winter Wheat Scab Nursery Triticum aestivum phenotype

[SUWWSN_2016_Newport](#) - The Triticeae Toolbox
Experiment Triticum aestivum
Experiment Triticeae Toolbox SUWWSN_2016_Newport phenotype trial traits=DON level **FHB** disease index **FHB** incidence **FHB** severity **FHB** grain incidence **FHB** ISK index Southern Uniform Winter Wheat Scab Nursery Triticum aestivum phenotype

[SUWWSN_2016_Urbana](#) - The Triticeae Toolbox
Experiment Triticum aestivum
Experiment Triticeae Toolbox SUWWSN_2016_Urbana phenotype trial traits=DON level **FHB** disease index **FHB** incidence **FHB** severity heading date **FHB** grain incidence **FHB** ISK index Southern Uniform Winter Wheat Scab Nursery Triticum aestivum phenotype

[SUWWSN_2016_Columbia](#) - The Triticeae Toolbox
Experiment Triticum aestivum
Experiment Triticeae Toolbox SUWWSN_2016_Columbia phenotype trial traits=DON level **FHB** disease index **FHB** incidence **FHB** severity heading date **FHB** grain incidence **FHB** ISK index Southern Uniform Winter Wheat Scab Nursery Triticum aestivum phenotype

[FHB](#) - GnpIS
Phenotype Triticum aestivum
Phenotype GnpIS **FHB** **FHB** is a trait related to Resistance, which unit is 'wu', described as follows: resistance contre Fusarium graminearum. Related keyword(s): Fusarium Head Blight (**FHB**) Triticum aestivum **FHB** ... (Expand)

[SUWWSN_2016_Lexington](#) - The Triticeae Toolbox
Experiment Triticum aestivum
Experiment Triticeae Toolbox SUWWSN_2016_Lexington phenotype trial traits=DON level **FHB** disease index **FHB** incidence **FHB** severity heading date plant height **FHB** grain incidence **FHB** ISK index Southern Uniform Winter Wheat Scab Nursery Triticum aestivu ... (Expand)

[SUWWSN_2016_Blacksburg](#) - The Triticeae Toolbox
Experiment Triticum aestivum
Experiment Triticeae Toolbox SUWWSN_2016_Blacksburg phenotype trial traits=DON level **FHB** disease index **FHB** incidence **FHB** severity heading date plant height grain yield test weight **FHB** grain incidence **FHB** ISK index

Database

- OpenMinTeD [121]
- The Triticeae Toolbox [84]
- GrainGenes [7]
- CIMMYT Dspace [2]
- GnpIS [2]
- Wheat Gene Catalog at Komugi [2]
- PlantPhenoDB [1]

Node

- URGI [123]
- T3 [84]
- GrainGenes [9]
- CIMMYT [2]
- IPGPAS [1]

Species

- Triticum [121]
- Triticum aestivum [95]
- Wheat [2]
- Triticum turgidum ssp. dicoccoides [1]
- Triticum turgidum ssp. durum [1]

New filters

yield Search

Results 1 to 20 from 2 704

10883/1551 - CIMMYT Dspace
Bibliography **Wheat yield**
CIMMYT Dspace Wheat **Yield** Publication 10883/1551 10883/1551 Herbicidal effect on the growth and **yield** of wheat 2009-01-01 Herbicidal effect on the growth and **yield** of wheat Article ... (Expand)

QYld.crc-2A - Wheat Gene Catalog at Komugi
Gene **Triticum aestivum**
Gene Wheat Gene Catalog at Komugi QYld.crc-2A [GrainGenes Summary] **Yield** and **Yield** Components; Grain **yield** Triticum aestivum

QYld.crc-4A - Wheat Gene Catalog at Komugi
Gene **Triticum aestivum**
Gene Wheat Gene Catalog at Komugi QYld.crc-4A [GrainGenes Summary] **Yield** and **Yield** Components; Grain **yield** Triticum aestivum

QYld.ndsu-5B - Wheat Gene Catalog at Komugi
Gene **Triticum aestivum**
Gene Wheat Gene Catalog at Komugi QYld.ndsu-5B [GrainGenes Summary] **Yield** and **Yield** Components; Grain **yield** Triticum aestivum

QYld.inra-7D - Wheat Gene Catalog at Komugi
Gene **Triticum aestivum**
Gene Wheat Gene Catalog at Komugi QYld.inra-7D [GrainGenes Summary] **Yield** and **Yield** Components; Grain **yield** Triticum aestivum

QGyld.unl-3A.1 - Wheat Gene Catalog at Komugi
Gene **Triticum aestivum**
Gene Wheat Gene Catalog at Komugi QGyld.unl-3A.1 [GrainGenes Summary] **Yield** and **Yield** Components; Grain **yield** Triticum aestivum

QGyld.unl-3A.2 - Wheat Gene Catalog at Komugi
Gene **Triticum aestivum**

Data type (18)

- Experiment [1 138]
- Gene annotation [701]
- Bibliography [636]
- Gene [53]
- Gwas [51]
- Phenotype [36]
- Interpro family [28]
- Qtl [17]

Other results are available.
Refine your search.

- CR-EST [5]
- CIMMYT dataverse [1]
- GEBIS [1]
- PlantPhenoDB [1]
- WheatIS File Repository [1]

Node

- URGI [1 671]
- T3 [597]
- Rothamsted Research [158]
- CIMMYT [129]
- Gramene [85]
- GrainGenes [46]
- South Green [11]
- IPK [6]
- IGPAS [1]



Usage metrics

2016

Summary			
Reported period	Year 2016		
First visit	01 Jul 2016 - 03:57		
Last visit	31 Dec 2016 - 00:42		
	Unique visitors	Number of visits	Pages
Viewed traffic *	<= 460 Exact value not available in 'Year' view	689 (1.49 visits/visitor)	3,609 (5.23 Pages/Visit)
Not viewed traffic *			110

* Not viewed traffic includes traffic generated by robots, worms, or replies with special HTTP status codes.

2017

Summary			
Reported period	Year 2017		
First visit	01 Jan 2017 - 15:36		
Last visit	31 Dec 2017 - 08:09		
	Unique visitors	Number of visits	Pages
Viewed traffic *	<= 1,556 Exact value not available in 'Year' view	2,236 (1.43 visits/visitor)	17,568 (7.85 Pages/Visit)
Not viewed traffic *			996































* Not viewed traffic includes traffic generated by robots, worms, or replies with special HTTP status codes.

2018

Summary			
Reported period	Year 2018		
First visit	07 Jan 2018 - 07:20		
Last visit	27 Nov 2018 - 07:33		
	Unique visitors	Number of visits	Pages
Viewed traffic *	<= 1,931 Exact value not available in 'Year' view	3,307 (1.71 visits/visitor)	27,371 (8.27 Pages/Visit)
Not viewed traffic *			604

* Not viewed traffic includes traffic generated by robots, worms, or replies with special HTTP status codes.

Countries for 2018

Countries (Top 30) - Full list					
Countries			Unique visitors	Number of visits	Pages
	China	cn	938 (48.6%)	1,606 (48.6%)	14,461
	United States	us	262 (13.6%)	449 (13.6%)	3,466
	France	fr	153 (7.9%)	261 (7.9%)	2,143
	Great Britain	gb	98 (5.1%)	168 (5.1%)	1,335
	South Africa	za	64 (3.3%)	110 (3.3%)	1,101
	India	in	96 (5.0%)	164 (5.0%)	957
	Germany	de	58 (3.0%)	100 (3.0%)	712
	Australia	au	53 (2.7%)	90 (2.7%)	645
	Japan	jp	38 (2.0%)	65 (2.0%)	425
	Canada	ca	27 (1.4%)	46 (1.4%)	290
	Argentina	ar	17 (0.9%)	29 (0.9%)	245
	Italy	it	13 (0.7%)	22 (0.7%)	180
	Mexico	mx	14 (0.7%)	24 (0.7%)	148
	Russian Federation	ru	10 (0.5%)	18 (0.5%)	133
	Spain	es	9 (0.5%)	16 (0.5%)	126
	Poland	pl	8 (0.4%)	15 (0.5%)	115
	Ethiopia	et	6 (0.3%)	10 (0.3%)	81
	Pakistan	pk	6 (0.3%)	10 (0.3%)	71
	Hong Kong	hk	5 (0.3%)	8 (0.2%)	65
	Belgium	be	5 (0.3%)	9 (0.3%)	65
	Saudi Arabia	sa	4 (0.2%)	7 (0.2%)	56
	Netherlands	nl	4 (0.2%)	6 (0.2%)	49
	Kuwait	kw	3 (0.2%)	4 (0.1%)	46
	Iran	ir	4 (0.2%)	7 (0.2%)	44
	Czech Republic	cz	4 (0.2%)	6 (0.2%)	41
	Chile	cl	3 (0.2%)	5 (0.2%)	39
	Moldova	md	2 (0.1%)	4 (0.1%)	32
	Denmark	dk	3 (0.2%)	4 (0.1%)	31
	Austria	at	3 (0.2%)	5 (0.2%)	28
	Norway	no	2 (0.1%)	4 (0.1%)	24

Promotion

- Computer Demo at PAG 2020 ?
- WheatIS logo ?
- Publication ?

I mentionned the tool in Alaux et al. *Genome Biology* 2018 (with acknowledgements to the WheatIS expert working group).

Acknowledgements



Questions

Alaux et al., *Genome Biology* 2018

<https://doi.org/10.1186/s13059-018-1491-4>



Linking the International Wheat Genome Sequencin...

The Wheat@URGI portal has been developed to provide the international community of researchers and breeders with access to the bread wheat reference genome se...

genomebiology.biomedcentral.com

URGI Contacts: michael.alaux@inra.fr



@michaelalaux

raphael.flores@inra.fr



@gnuraph

thomas.letellier@inra.fr

cyril.pommier@inra.fr

hadi.quesneville@inra.fr



@hquesneville